

ESPAÇOS PARA A FELICIDADE

SPACES FOR HAPPINESS . ESPACIOS PARA LA FELICIDAD
DES ESPACES POUR LE BONHEUR



artimentos

artefactos de cimento . artefactos de cemento
cement artifacts . artefacts de ciment



MATERIAL URBANO

URBAN MATERIAL
MATERIAL URBANO
MATÉRIEL URBAINE

MATERIAL DECORATIVO

DECORATION MATERIAL
MATERIAL DE DECORACIÓN
MATÉRIEL DÉCORATIF

MATERIAL DE CONSTRUÇÃO CIVIL

CIVIL CONSTRUCTION MATERIAL
MATERIAL DE CONSTRUCCIÓN CIVIL
MATÉRIEL DE CONSTRUCTION CIVIL

MOBILIÁRIO DE JARDIM

GARDEN FURNITURE
MOBILIARIO DE JARDÍN
MOBILIER DE JARDIN

CHURRASQUEIRAS E ACESSÓRIOS

BARBECUES AND ACCESSORIES
BARBACOAS Y ACCESORIOS
GRILLS ET ACCESSOIRES



03

MATERIAL URBANO

URBAN MATERIAL
MATERIAL URBANO
URBAN MATÉRIAL



29

VASOS E FLOREIRAS

VASES AND PLANTS STANDS
VASOS Y JARDINERAS
VASES ET POTS DE FLEURS



33

MESAS E BANCOS

TABLE AND BENCHES
MESAS Y BANCOS
TABLE ET BANCS



45

BASES DE CHAPÉUS

UMBRELLA STANDS
BASES PARA SOMBREROS
BASES POUR DES PARASOLS



51

FONTES

FOUNTAINS
FUENTES
FONTAINES



54

DIVERSOS

OTHERS
DIVERSOS
DIVERS



57

A EMPRESA

THE COMPANY . L'ENTREPRISE . LA EMPRESA



A Artimentos foi fundada em 1978, em S. Jorge, Porto de Mós.

Dez anos mais tarde, foram inauguradas as novas instalações da fábrica, na Zona Industrial da Batalha e o espaço da antiga sede passou a direcionar-se, apenas, para a venda direta ao público.

O sucesso da Artimentos é o resultado do esforço e dedicação de uma equipa de profissionais competentes, aliados a uma estrutura organizacional integrada, que pressupõe a conceção e design exclusivos de cada peça, a obtenção das melhores matérias-primas aplicadas, rigorosos processos produtivos e uma avançada e eficiente rede de distribuição.

Só uma relação de cooperação e comunicação constantes entre os diversos departamentos e o cliente permitem que a Artimentos ofereça soluções práticas e exclusivas, adequadas a cada espaço e respeitando, sempre, o ambiente.

Artimentos fue fundada en 1978, en S. Jorge, Porto de Mós.

Diez años más tarde, se inauguraron las nuevas instalaciones de la fábrica, en Zona Industrial de Batalha y el espacio de la antigua sede empezó a ser exclusivamente destinado a la venta directa al público.

El suceso de Artimentos resulta del esfuerzo y dedicación de un equipo de profesionales competentes, aliado a una estructura organizacional integrada, que presupone la concepción y design exclusivos de cada pieza, la obtención de las mejores materias-primas aplicadas, rigurosos procesos productivos y una avanzada e eficiente red de distribución.

Solo una relación de cooperación y comunicación constantes entre los varios departamentos y el cliente permiten que Artimentos ofrece soluciones prácticas y exclusivas, adecuadas a cada espacio y respetando siempre el ambiente.

Artimentos was founded in 1978, in S. Jorge, Porto de Mós.

Ten years later, the new facilities of the factory were established, in Batalha's Industrial Area, and the old headquarters became directed only for direct sales to the public.

The success of Artimentos is the result of the effort and dedication of a team of competent professionals, gathered with an integrated organizational structure, which implies the exclusive design of each piece of work, the use of the best applied prime-matters, thorough production processes and an advanced and efficient distribution network.

Only through a constant relationship of communication and cooperation between the several departments and the client can Artimentos offer practical and exclusive solutions, adequate to each space and always with the most respect for the environment.

L'Artimentos a été fondée en 1978, à S. Jorge, Porto de Mós.

Dix ans plus tard, les nouvelles installations de l'usine ont été inaugurées dans la zone industrielle de Batalha et, depuis cette date, le siège ancien se dédie seulement à la vente directe au public.

Le succès de l'Artimentos est le résultat d'une équipe de professionnels compétents, alliés à une structure organisationnelle intégrée, qui présuppose la conception et design exclusifs de chaque pièce, l'obtention des meilleures matières premières appliquées, des rigoureux processus de production et une réseau de distribution avancée et efficiente.

Seule une relation de coopération et communication constantes entre les divers départements et le client permettent à l'Artimentos d'offrir des solutions pratiques et exclusives, propres pour chaque espace et en respectant, toujours, l'environnement.

CHURRASQUEIRAS E ACESSÓRIOS

BARBECUES AND ACCESSORIES
BARBACOAS Y ACCESORIOS
GRILLS ET ACCESSOIRES



MAXI



GRELHA INCLUÍDA REF. 95
GRILL INCLUDED · PARRILA INCLUIDA · GRILL INCLUS



ref. 977 + 979

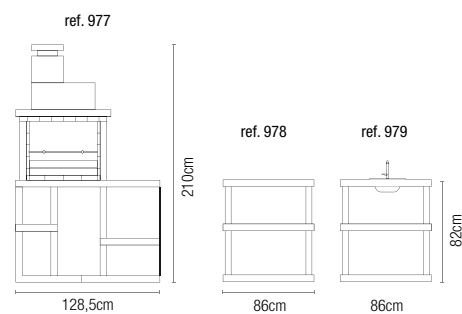

| | | | |
|-----|------------------------|----------------|-------|
| 977 | Churrasqueira MAXI | 128,5x55x210cm | 830Kg |
| 978 | Módulo bancada MAXI | 86x55x82cm | 305Kg |
| 979 | Módulo lava loiça MAXI | 86x55x82cm | 305Kg |



MIDI



GRELHA INCLUIDA REF. 178
GRILL INCLUDED · PARRILA INCLUIDA · GRILL INCLUS

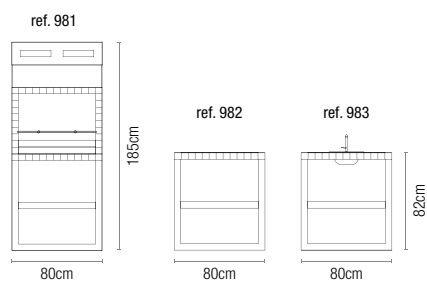

| | | | |
|-----|------------------------|--------------|-------|
| 981 | Churrasqueira MIDI | 80x57x185cm | 487Kg |
| 982 | Módulo bancada MIDI | 80x56,5x82cm | 232Kg |
| 983 | Módulo lava loiça MIDI | 80x56,5x82cm | 232Kg |

ref. 981

MINI

NEW

| | | | |
|-----|--------------------------|-------------|-------|
| 986 | Churrasqueira MINI LIGHT | 60x45x174cm | 307Kg |
| 987 | Módulo bancada MINI | 60x45x80cm | 144Kg |
| 988 | Módulo lava loiça MINI | 60x45x80cm | 144Kg |



GRELHA INCLUÍDA REF. 139B
GRILL INCLUDED · PARRILA INCLUIDA · GRILL INCLUS

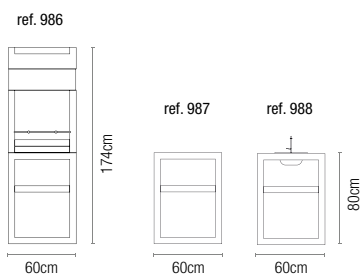

ref. 986



PALMEIRA



PRETO/BRANCO OU BRITA
BLACK/WHITE OR GRAVEL
NEGRO/BLANCO O GRAVA
NOIR/BLANC OU GRAVIER



ref. 792

ref. 792, 807

ref. 793, 808

ref. 794, 809

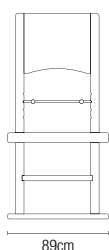

89cm

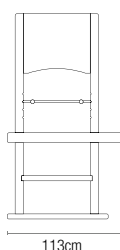

113cm

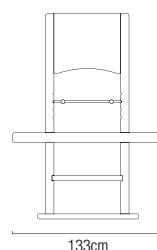

133cm

181cm



GRELHAS INCLuíDAS REF. 651 E 143
GRILLS INCLUDED . PARRILAS INCLUIDAS
GRILLS INCLUS



| | | | |
|-----|---|--------------|-------|
| 792 | Churrasqueira PALMEIRA Black simples c/ grelha | 89x62x181cm | 521Kg |
| 793 | Churrasqueira PALMEIRA Black c/ 1 mini bancada c/ grelha | 113x62x181cm | 544Kg |
| 794 | Churrasqueira PALMEIRA Black c/ 2 mini bancadas c/ grelha | 133x62x181cm | 559Kg |
| 807 | Churrasqueira PALMEIRA brita simples | 89x62x181cm | 521Kg |
| 808 | Churrasqueira PALMEIRA brita c/ 1 mini bancada | 113x62x181cm | 544Kg |
| 809 | Churrasqueira PALMEIRA brita c/ 2 mini bancadas | 133x62x181cm | 559Kg |

BLACKWHITE



ref.908

ref. 905

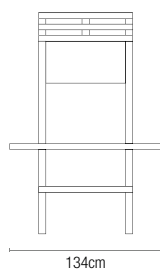

134cm

ref. 906

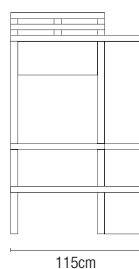

115cm

ref. 907

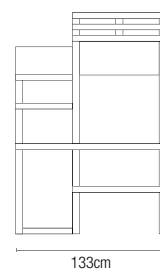

133cm

ref. 908

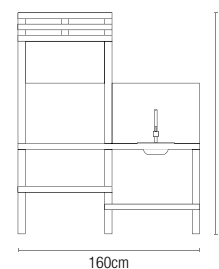

160cm

195cm

| | | | |
|-----|---|--------------|-------|
| 905 | Churrasqueira BLACKWHITE c/ 2 abas | 134x57x195cm | 430Kg |
| 906 | Churrasqueira BLACKWHITE c/ 2 prateleiras | 115x57x195cm | 610Kg |
| 907 | Churrasqueira BLACKWHITE c/ 1 bancada | 133x57x195cm | 648Kg |
| 908 | Churrasqueira BLACKWHITE c/lava-louça | 160x57x195cm | 639Kg |

COMPATÍVELS COM A GRELHA REF. 178
 COMPATIBLE WITH GRILL · COMPATIBLE CON PARRILLA
 COMPATIBLE AVEC GRILL



GRAY



ref. 797

| | | | |
|-----|---------------------------------------|--------------|-------|
| 795 | Churrasqueira GRAY simples | 79x58x202cm | 475Kg |
| 796 | Churrasqueira GRAY c/ 1 mini bancada | 105x58x202cm | 481Kg |
| 797 | Churrasqueira GRAY c/ 2 mini bancadas | 125x58x202cm | 487Kg |

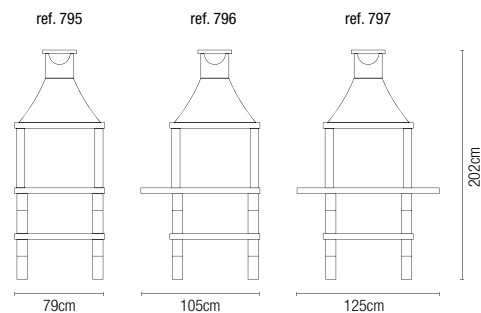

COMPATÍVEIS COM AS GRELHAS REF. 658 E 139B
 COMPATIBLE WITH GRILL · COMPATIBLE CON PARRILA
 COMPATIBLE AVEC GRILL



STONE



TIJOLO VERMELHO OU MATIZADO, IMITAÇÃO PEDRA PRETA
 RED OR MOTTLED BRICK, BLACK STONE IMITATION
 LADRILLO ROJO O MATIZADO, IMITACIÓN PIEDRA NEGRA
 BRIQUE ROUGE OU NUANCÉ, IMITATION PIERRE NOIRE



ref. 884

| | | | |
|-----|--|--------------|-------|
| 882 | Churrasqueira STONE c/ 2 mini bancadas | 124x57x231cm | 420Kg |
| 883 | Churrasqueira STONE simples | 85x57x231cm | 385Kg |
| 884 | Churrasqueira STONE c/ 1 mini bancada | 124x57x231cm | 523Kg |
| 885 | Churrasqueira STONE c/ 2 mini bancadas | 156x57x231cm | 630Kg |
| 886 | Churrasqueira STONE c/ lava louça | 156x57x231cm | 630Kg |

ref. 883

ref. 882

ref. 884

ref. 885

ref. 886

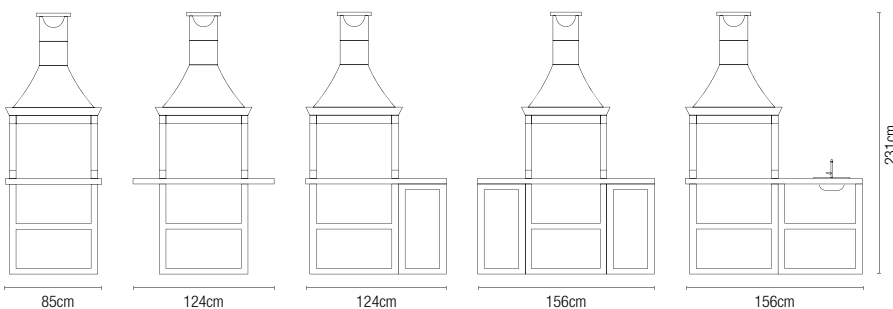

COMPATÍVEIS COM A GRELHA REF. 178
 COMPATIBLE WITH GRILL · COMPATIBLE CON PARRILA
 COMPATIBLE AVEC GRILL



ROCK

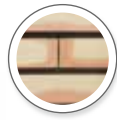

TIJOLO VERMELHO OU MATIZADO
 ALSO AVAILABLE IN RED OR MOTTLED BRICK
 TAMBIÉN DISPONIBLE EN LADRILLO ROJO O MATIZADO
 AUSSI DISPONIBLE EN BRIQUE ROUGE OU NUANCÉ



ref. 203

COMPATÍVEIS COM AS GRELHAS REF. 310 E 178
 COMPATIBLE WITH GRILL . COMPATIBLE CON PARRILLA
 COMPATIBLE AVEC GRILL



| | | | |
|-----|-------------------------------------|--------------|-------|
| 203 | Churrasqueira ROCK c/ lava louça | 214x57x245cm | 725Kg |
| 204 | Churrasqueira ROCK simples | 91x57x245cm | 538Kg |
| 205 | Churrasqueira ROCK c/ 1 prateleira | 128x57x254cm | 554Kg |
| 206 | Churrasqueira ROCK c/ 4 prateleiras | 202x57x245cm | 810Kg |
| 207 | Churrasqueira ROCK canto | 175x57x245cm | 813Kg |
| 209 | Churrasqueira ROCK c/ 2 bancadas | 150x57x245cm | 599Kg |

ref. 203

ref. 204

ref. 205

ref. 206

ref. 207

ref. 209

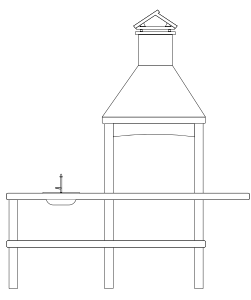

214cm



91cm

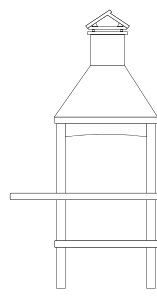

130cm

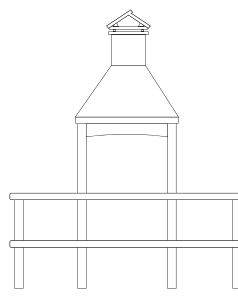

202cm

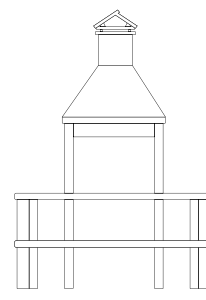

175cm

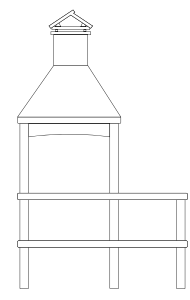

150cm

245cm

GROVE

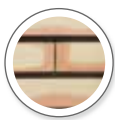

TIJOLO VERMELHO OU MATIZADO
ALSO AVAILABLE IN RED OR MOTTLED BRICK
TAMBIÉN DISPONIBLE EN LADRILLO ROJO O MATIZADO
AUSSI DISPONIBLE EN BRIQUE ROUGE OU NUANCÉ

| | | | |
|-----|--------------------------------------|--------------|-------|
| 212 | Churrasqueira GROVE simples | 91x57x244cm | 455Kg |
| 213 | Churrasqueira GROVE c/ 1 prateleira | 128x57x244cm | 476Kg |
| 214 | Churrasqueira GROVE c/ 2 bancadas | 150x57x244cm | 592Kg |
| 215 | Churrasqueira GROVE lava louça | 214x57x244cm | 613Kg |
| 216 | Churrasqueira GROVE c/ 4 prateleiras | 205x57x244cm | 683Kg |

COMPATÍVEIS COM AS GRELHAS REF. 310 E 178
COMPATIBLE WITH GRILL · COMPATIBLE CON PARRILA
COMPATIBLE AVEC GRILL



ref. 213



ref. 212

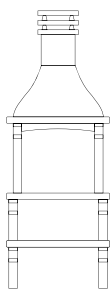

91cm

ref. 213

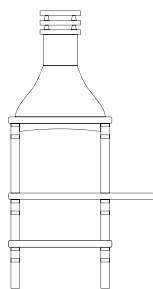

128cm

ref. 214

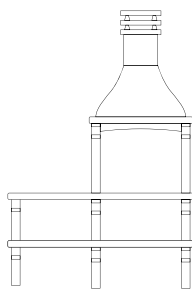

150cm

ref. 215

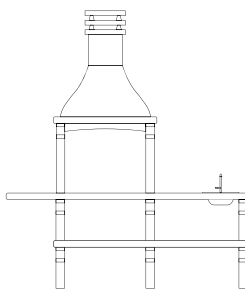

214cm

ref. 216

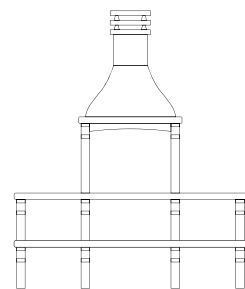

205cm

244cm

OVEN



TIJOLO VERMELHO OU MATIZADO
 ALSO AVAILABLE IN RED OR MOTTLED BRICK
 TAMBIÉN DISPONIBLE EN LADRILLO ROJO O MATIZADO
 AUSSI DISPONIBLE EN BRIQUE ROUGE OU NUANCÉ

| | | | |
|-----|---|------------------|--------|
| 179 | Churrasqueira OVEN brita c/ lava louça e torneira | 242x90x240cm | 950Kg |
| 195 | Churrasqueira OVEN brita | 242x90x240cm | 950Kg |
| 984 | Churrasqueira OVEN II | 103x250x57x258cm | 1390Kg |
| 985 | Churrasqueira OVEN brita s/ bancada | 187x90x240cm | 900Kg |

COMPATÍVEIS COM A GRELHA REF. 95
 COMPATIBLE WITH GRILL . COMPATIBLE CON PARRILA
 COMPATIBLE AVEC GRILL



ref. 984



FORNO DE BARRO Ø80CM . CLAY OVEN
 HORNO DE BARRO . FOUR DE ARGILE
 OUTRAS COMBINAÇÕES SOB CONSULTA
 OTHER COMBINATIONS ON REQUEST
 OTRAS COMBINACIONES BAJO PEDIDO
 D'AUTRES COMBINAISONS SUR DEMANDE

ref. 179

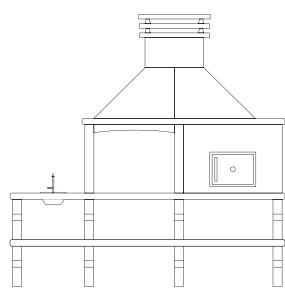

242cm

ref. 195

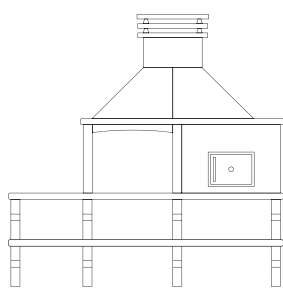

242cm

ref. 985

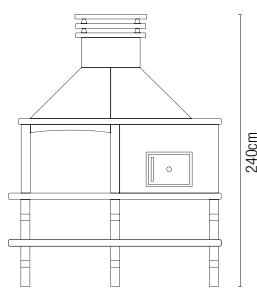

187cm

240cm

ref. 984

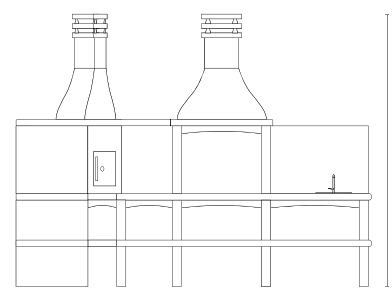

258cm

250cm

BRICK

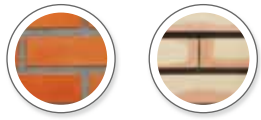

TIJOLO VERMELHO OU MATIZADO
 ALSO AVAILABLE IN RED OR MOTTLED BRICK
 TAMBIÉN DISPONIBLE EN LADRILLO ROJO O MATIZADO
 AUSSI DISPONIBLE EN BRIQUE ROUGE OU NUANCÉ



ref. 168



ref. 879

REF. 168, 169, 193, 194, 211 COMPATÍVEIS COM AS GRELHAS REF. 310 E 178
 REF. 875, 879 COMPATÍVEIS COM AS GRELHAS REF. 659 E 139B
 COMPATIBLE WITH GRILL · COMPATIBLE CON PARRILA
 COMPATIBLE AVEC GRILL



| | | | |
|-----|---------------------------------------|--------------|-------|
| 168 | Churrasqueira BRICK c/ 4 prateleiras | 202x57x245cm | 700Kg |
| 169 | Churrasqueira BRICK c/ 2 bancadas | 150x57x245cm | 571Kg |
| 193 | Churrasqueira BRICK simples | 91x57x245cm | 541Kg |
| 194 | Churrasqueira BRICK c/ 1 prateleira | 128x57x245cm | 553Kg |
| 211 | Churrasqueira BRICK canto | 175x57x245cm | 705Kg |
| 875 | Churrasqueira BRICK simples (1) | 78x51x210cm | 359Kg |
| 879 | Churrasqueira BRICK c/ 2 bancadas (1) | 128x51x216cm | 482Kg |

ref. 168

ref. 169

ref. 193

ref. 194

ref. 211

ref. 875

ref. 879

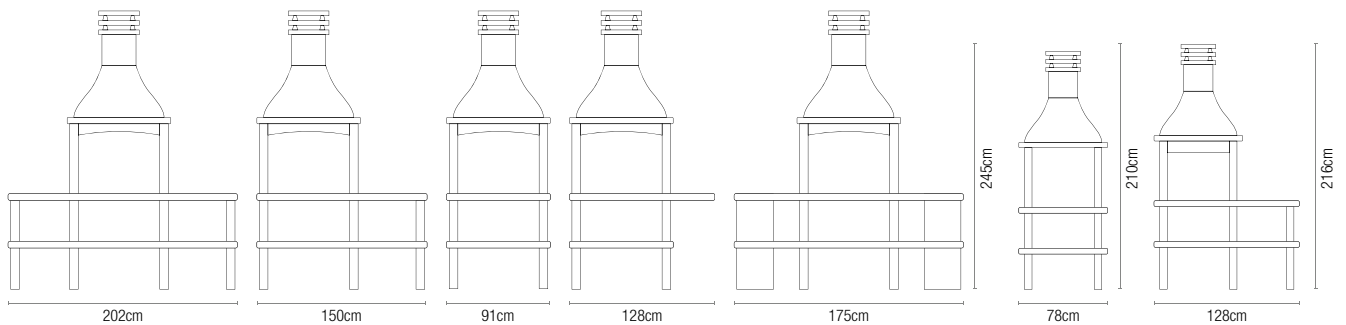

EIFFEL



TIJOLO VERMELHO OU MATIZADO
 ALSO AVAILABLE IN RED OR MOTTLED BRICK
 TAMBIÉN DISPONIBLE EN LADRILLO ROJO O MATIZADO
 AUSSI DISPONIBLE EN BRIQUE ROUGE OU NUANCÉ

ref. 894

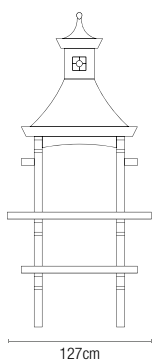

127cm

ref. 895

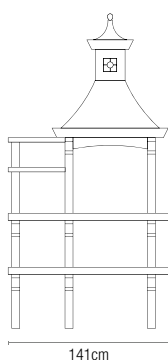

141cm

ref. 896

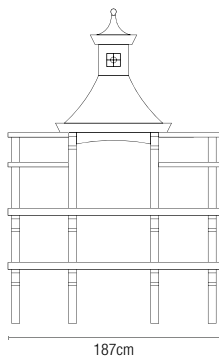

187cm

ref. 897

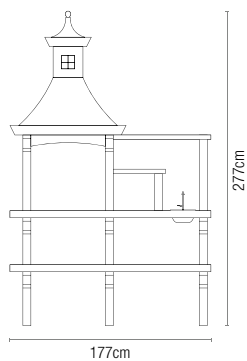

177cm

277cm



ref. 894

| | | | |
|-----|------------------------------------|--------------|-------|
| 894 | Churrasqueira EIFFEL c/ 2 abas | 127x57x277cm | 558Kg |
| 895 | Churrasqueira EIFFEL c/ 2 bancadas | 141x57x277cm | 646Kg |
| 896 | Churrasqueira EIFFEL c/ 4 bancadas | 187x57x277cm | 829Kg |
| 897 | Churrasqueira EIFFEL c/ lava louça | 177x57x277cm | 818Kg |

COMPATÍVEIS COM AS GRELHAS REF. 310 E 178
 COMPATIBLE WITH GRILL . COMPATIBLE CON PARRILA
 COMPATIBLE AVEC GRILL



LIBERTY



TIJOLO VERMELHO OU MATIZADO
ALSO AVAILABLE IN RED OR MOTTLED BRICK
TAMBIÉN DISPONIBLE EN LADRILLO ROJO O MATIZADO
AUSSI DISPONIBLE EN BRIQUE ROUGE OU NUANCÉ



ref. 197



ref. 804

| | | | |
|-----|--|--------------|-------|
| 197 | Churrasqueira LIBERTY c/ 2 prateleiras | 139x60x242cm | 615Kg |
| 804 | Churrasqueira LIBERTY c/ 2 bancadas | 197x64x247cm | 715Kg |
| 868 | Churrasqueira LIBERTY c/ 2 telhados | 124x57x240cm | 640Kg |
| 993 | Churrasqueira LIBERTY simples | 117x65x225cm | 597Kg |

ref. 197

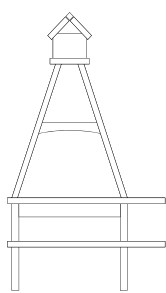

139cm

ref. 804

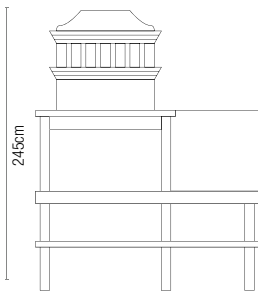

197cm

ref. 868

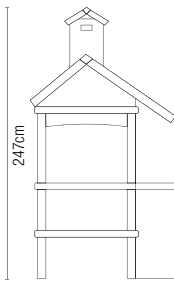

124cm

ref. 993

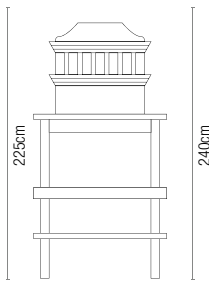

117cm

240cm

REF. 197 E 804 COMPATÍVEIS COM A GRELHA REF. 95
REF. 868 COMPATÍVEL COM A GRELHA REF. 178
REF. 993 COMPATÍVEL COM A GRELHA REF. 1018
COMPATIBLE WITH GRILL · COMPATIBLE CON PARRILLA
COMPATIBLE AVEC GRILL





ref. 868



ref. 993



FOCUS

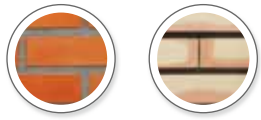

TIJOLO VERMELHO OU MATIZADO
 ALSO AVAILABLE IN RED OR MOTTLED BRICK
 TAMBIÉN DISPONIBLE EN LADRILLO ROJO O MATIZADO
 AUSSI DISPONIBLE EN BRIQUE ROUGE OU NUANCÉ



ref. 825

ref. 824

ref. 825

ref. 826

ref. 827

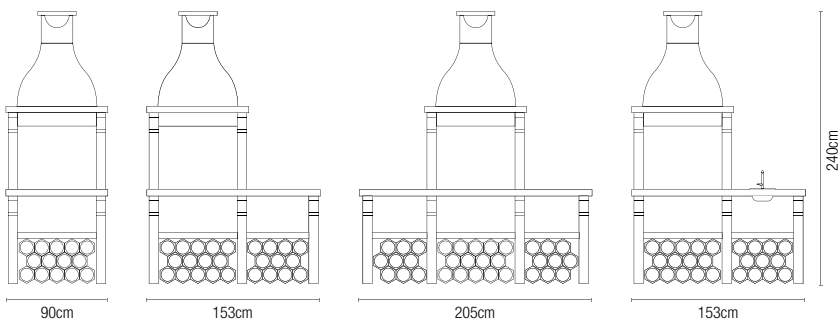

90cm

153cm

205cm

153cm

240cm

| | | | |
|-----|-----------------------------------|--------------|-------|
| 824 | Churrasqueira FOCUS simples | 90x57x240cm | 549Kg |
| 825 | Churrasqueira FOCUS c/ 2 bancadas | 153x57x240cm | 625Kg |
| 826 | Churrasqueira FOCUS c/ 4 bancadas | 205x57x240cm | 815Kg |
| 827 | Churrasqueira FOCUS c/ lava louça | 153x57x240cm | 625Kg |

COMPATÍVEIS COM AS GRELHAS REF. 310 E 178
 COMPATIBLE WITH GRILL · COMPATIBLE CON PARRILA
 COMPATIBLE AVEC GRILL



LARGE



TIJOLO VERMELHO OU MATIZADO
 ALSO AVAILABLE IN RED OR MOTTLED BRICK
 TAMBIÉN DISPONIBLE EN LADRILLO ROJO O MATIZADO
 AUSSI DISPONIBLE EN BRIQUE ROUGE OU NUANCÉ



ref. 893

ref. 890

ref. 891

ref. 892

ref. 893

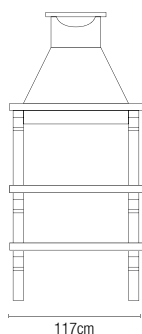

117cm

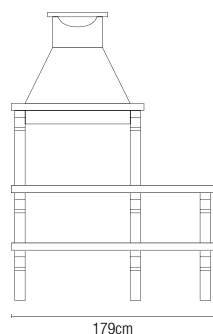

179cm

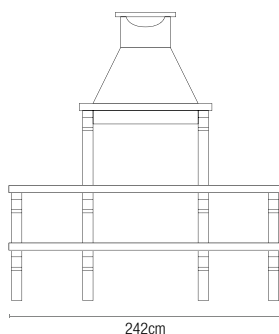

242cm

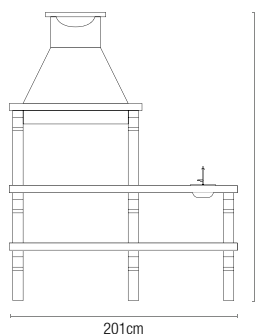

201cm

255cm

| | | | |
|-----|-----------------------------------|--------------|-------|
| 890 | Churrasqueira LARGE simples | 117x68x255cm | 587Kg |
| 891 | Churrasqueira LARGE c/ 2 bancadas | 179x68x255cm | 686Kg |
| 892 | Churrasqueira LARGE c/ 4 bancadas | 242x68x255cm | 865Kg |
| 893 | Churrasqueira LARGE c/ lava louça | 201x68x255cm | 728Kg |

COMPATÍVEIS COM AS GRELHAS REF. 311 E 1018
 COMPATIBLE WITH GRILL . COMPATIBLE CON PARRILA
 COMPATIBLE AVEC GRILL



PETRA



TIJOLO VERMELHO OU MATIZADO
ALSO AVAILABLE IN RED OR MOTTLED BRICK
TAMBIÉN DISPONIBLE EN LADRILLO ROJO O MATIZADO
AUSSI DISPONIBLE EN BRIQUE ROUGE OU NUANCÉ



ref. 788



ref. 182

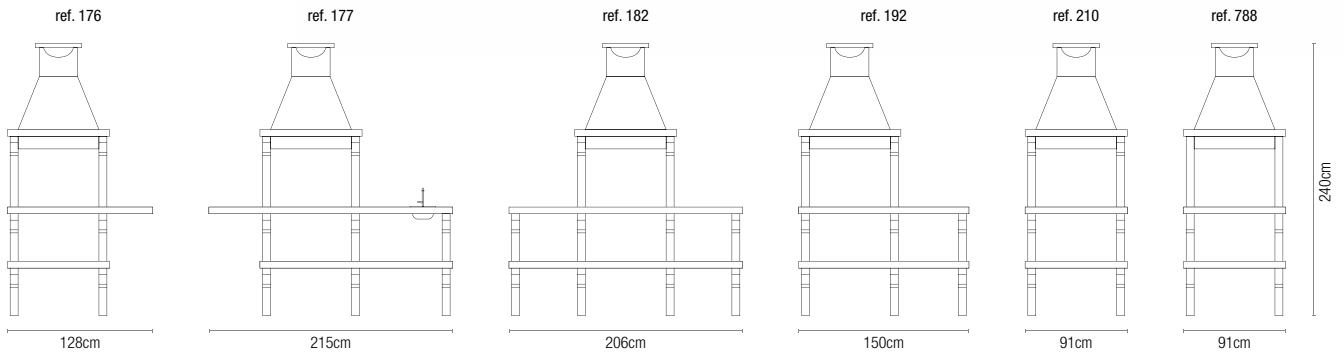

| | | | |
|-----|--|--------------|-------|
| 176 | Churrasqueira PETRA c/ 1 prateleira | 124x57x240cm | 466Kg |
| 177 | Churrasqueira PETRA c/ lava louça | 215x57x240cm | 603Kg |
| 182 | Churrasqueira PETRA c/ 4 prateleira | 206x57x240cm | 673Kg |
| 192 | Churrasqueira PETRA c/ 2 bancadas | 150x57x240cm | 582Kg |
| 210 | Churrasqueira PETRA simples | 91x57x240cm | 445Kg |
| 788 | Churrasqueira PETRA simples, laterais tijolo | 91x57x240cm | 445Kg |

COMPATÍVEIS COM AS GRELHAS REF. 310 E 178
COMPATIBLE WITH GRILL · COMPATIBLE CON PARRILLA
COMPATIBLE AVEC GRILL



CROOK



TIJOLO VERMELHO OU MATIZADO
 ALSO AVAILABLE IN RED OR MOTTLED BRICK
 TAMBIÉN DISPONIBLE EN LADRILLO ROJO O MATIZADO
 AUSSI DISPONIBLE EN BRIQUE ROUGE OU NUANCÉ



(1) PRATELEIRA DE BAIXO EM CIMENTO
 BOTTOM SHELVES IN BRICK
 ESTANTE INFERIOR EN LADRILLO
 ETAGERE DU FOND EN BRIQUE



(2) PRATELEIRA DE BAIXO EM TIJOLO
 BOTTOM SHELVES IN BRICK
 ESTANTE INFERIOR EN LADRILLO
 ETAGERE DU FOND EN BRIQUE

COMPATÍVEIS COM AS GRELHAS REF. 659 E 139
 COMPATIBLE WITH GRILL · COMPATIBLE CON PARRILA · COMPATIBLE AVEC GRILL



ref. 760

| | | | |
|-----|---|--------------|-------|
| 759 | Churrasqueira CROOK II simples (1) | 78x57x204cm | 381Kg |
| 760 | Churrasqueira CROOK II c/ 2 prateleiras (1) | 124x57x204cm | 408Kg |
| 877 | Churrasqueira CROOK c/ 2 prateleiras (2) | 124x57x204cm | 408Kg |
| 878 | Churrasqueira CROOK simples (2) | 78x57x204cm | 381Kg |
| 880 | Churrasqueira CROOK c/ 2 bancadas (2) | 141x57x204cm | 495Kg |
| 881 | Churrasqueira CROOK c/ 4 bancadas (2) | 183x57x204cm | 611Kg |

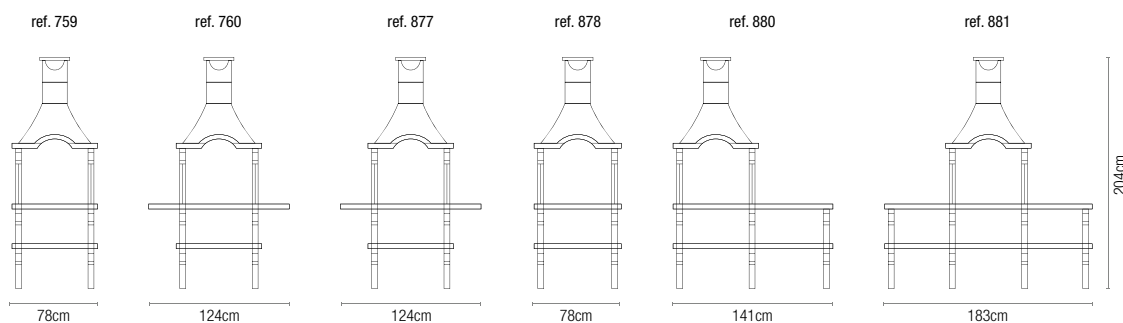

EYE



TIJOLO VERMELHO OU MATIZADO
 ALSO AVAILABLE IN RED OR MOTTLED BRICK
 TAMBIÉN DISPONIBLE EN LADRILLO ROJO O MATIZADO
 AUSSI DISPONIBLE EN BRIQUE ROUGE OU NUANCÉ



ref. 823



ref. 856

COMPATÍVEIS COM AS GRELHAS REF. 659 E 139
 COMPATIBLE WITH GRILL · COMPATIBLE CON PARRILLA
 COMPATIBLE AVEC GRILL



| | | | |
|-----|---|--------------|-------|
| 823 | Churrasqueira EYE c/ 2 bancadas c/ lava louça (2) | 135x57x195cm | 492Kg |
| 853 | Churrasqueira EYE c/ 1 prateleira (1) | 110x57x195cm | 396Kg |
| 854 | Churrasqueira EYE c/ 2 prateleiras (1) | 124x57x195cm | 406Kg |
| 856 | Churrasqueira EYE c/ lava louça (2) | 166x57x207cm | 440Kg |
| 870 | Churrasqueira EYE simples (1) | 78x57x195cm | 381Kg |
| 876 | Churrasqueira EYE simples (2) | 76x57x195cm | 379Kg |
| 888 | Churrasqueira EYE c/ 2 bancadas (2) | 135x57x195cm | 492Kg |
| 938 | Churrasqueira EYE c/ 2 prateleiras (2) | 166x57x207cm | 440Kg |



(1) PRATELEIRA DE BAIXO EM CIMENTO
 BOTTOM SHELVES IN BRICK
 ESTANTE INFERIOR EN LADRILLO
 ETAGERE DU FOND EN BRIQUE



(2) PRATELEIRA DE BAIXO EM TIJOLO
 BOTTOM SHELVES IN BRICK
 ESTANTE INFERIOR EN LADRILLO
 ETAGERE DU FOND EN BRIQUE

ref. 823

ref. 853

ref. 854

ref. 870

ref. 876

ref. 888

ref. 856

ref. 938

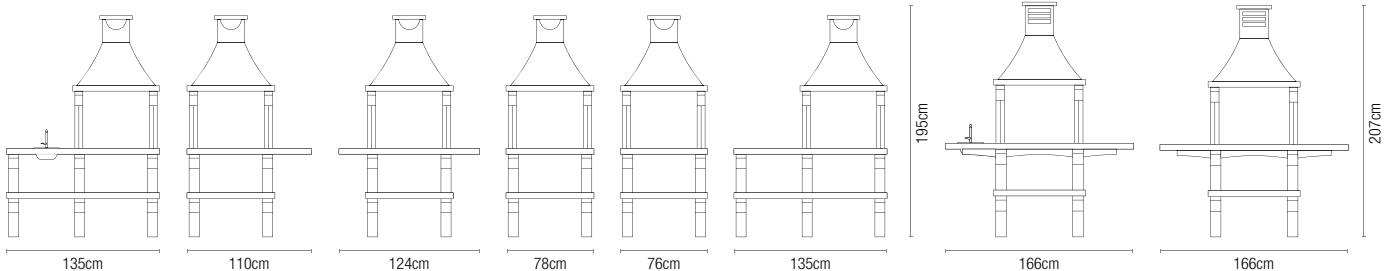



TIJOLO VERMELHO OU MATIZADO
 ALSO AVAILABLE IN RED OR MOTTLED BRICK
 TAMIÉN DISPONIBLE EN LADRILLO ROJO O MATIZADO
 AUSSI DISPONIBLE EN BRIQUE ROUGE OU NUANCÉ



ref.734



ref.758

| | | | |
|-----|--|--------------|-------|
| 734 | Churrasqueira X-ART c/ 2 bancadas c/ lava louça e torneira | 142x50x193cm | 346Kg |
| 756 | Churrasqueira X-ART simples (laterais tijolo) | 72x50x193cm | 315Kg |
| 757 | Churrasqueira X-ART c/ 1 prateleira (laterais em tijolo) | 98x50x193cm | 318Kg |
| 758 | Churrasqueira X-ART c/ 2 prateleiras (laterais em tijolo) | 123x50x193cm | 322Kg |
| 787 | Churrasqueira X-ART simples | 72x50x193cm | 315Kg |
| 789 | Churrasqueira X-ART c/ 2 bancadas | 142x50x193cm | 346Kg |
| 790 | Churrasqueira X-ART c/ 1 mini bancada | 98x50x193cm | 318Kg |
| 791 | Churrasqueira X-ART c/ 2 mini bancadas | 123x50x193cm | 322Kg |

COMPATÍVEIS COM AS GRELHAS REF. 658 E 139B
 COMPATIBLE WITH GRILL · COMPATIBLE CON PARRILLA
 COMPATIBLE AVEC GRILL

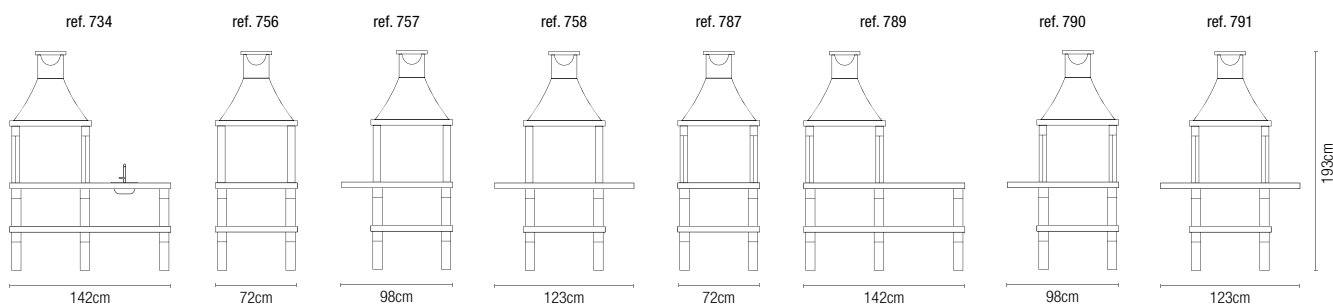

MINUS



TIJOLO VERMELHO OU MATIZADO
ALSO AVAILABLE IN RED OR MOTTLED BRICK
TAMBIÉN DISPONIBLE EN LADRILLO ROJO O MATIZADO
AUSSI DISPONIBLE EN BRIQUE ROUGE OU NUANCÉ



ref. 914A



ref. 188



ref. 942

| | | | |
|------|--|--------------|-------|
| 913 | Churrasqueira MINUS simples (bancada baixo cimento) | 77x57x112cm | 244Kg |
| 914A | Churrasqueira MINUS II simples (bancada baixo cimento) | 72x46x112cm | 192Kg |
| 940 | Churrasqueira MINUS II c/bancada (bancada baixo cimento) | 141x46x112cm | 282Kg |
| 941 | Churrasqueira MINUS III simples | 77x57x119cm | 249Kg |
| 942 | Churrasqueira MINUS III c/2 prateleiras | 128x57x119cm | 260Kg |
| 173 | Churrasqueira MINUS c/ 1 prateleira | 128x57x108cm | 321Kg |
| 184 | Churrasqueira MINUS simples | 91x57x108cm | 296Kg |
| 188 | Churrasqueira MINUS c/ 2 bancadas | 150x57x108cm | 350Kg |

REF. 184 E 188
COMPATÍVEIS COM AS GRELHAS REF. 310 E 178
REF. 914A, 940, 941 E 942
COMPATÍVEIS COM AS GRELHAS REF. 658 E 139B
COMPATIBLE WITH GRILL · COMPATIBLE CON PARRILLA
COMPATIBLE AVEC GRILL



77cm

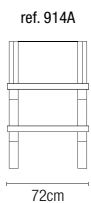

72cm

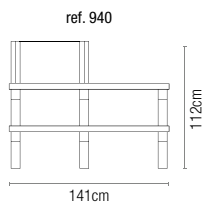

141cm

112cm



77cm

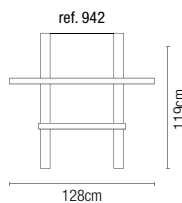

128cm

119cm

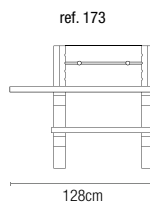

128cm

ref. 173

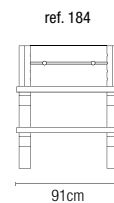

91cm

ref. 184

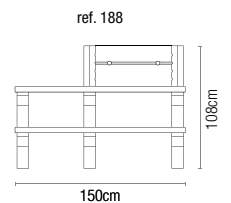

150cm

108cm

ref. 188



ref. 95, 139, 139B, 178, 1018



ref. 141



ref. 1021



ref. 1022



ref. 143



ref. 310, 311, 651, 658, 659



ref. 145



ref. 146



ref. 175



| | | | |
|------|-------------------------------|------------|------|
| 95 | Grelhador simples grande | 70x40x30cm | 20Kg |
| 139 | Grelhador simples pequeno | 52x40x30cm | 11Kg |
| 139B | Grelhador simples mini | 48x35x30cm | 9Kg |
| 178 | Grelhador simples médio | 60x40x30cm | 15Kg |
| 1018 | Grelhador simples gigante | 78x45x30cm | 22Kg |
| 141 | Grelhador simples médio inox | 60x40x30cm | 16Kg |
| 1021 | Grelhador c/1 rotativo médio | 60x40x30cm | 19Kg |
| 1022 | Grelhador c/2 rotativos médio | 60x40x30cm | 20Kg |
| 143 | Grelhador rasa | 57x40cm | 12Kg |
| 310 | Grelha grande | 63x40cm | 4Kg |
| 311 | Grelha gigante | 83x44cm | 5Kg |
| 651 | Grelha média | 60x40cm | 4Kg |
| 658 | Grelha mini | 52x40cm | 3Kg |
| 659 | Grelha pequena | 56x40cm | 3Kg |
| 145 | Grelha com calhas | 58x38cm | 4Kg |
| 146 | Grelha em chapa | 58x38cm | 3Kg |
| 175 | Grelha elétrica | 60x64cm | 3Kg |
| 171 | Trempe de Paelha | 58x38cm | 3Kg |
| 997 | Acessórios de Churrasqueira | - | - |



ref. 171



ref. 997

FUGAS

LEAKAGE SYSTEMS
FUGAS
FUJTES



(1) TAMBÉM DISPONÍVEL EM AMARELO ref. 117A
ALSO AVAILABLE IN YELLOW
TAMBIÉN DISPONIBLE EN AMARILLO
AUSSI DISPONIBLE EN JAUNE



(2) TAMBÉM DISPONÍVEL EM PRETO ref. 247
ALSO AVAILABLE IN BLACK
TAMBIÉN DISPONIBLE EN NEGRO
AUSSI DISPONIBLE EN NOIRE



(3) TAMBÉM DISPONÍVEL EM MATIZADO
ALSO AVAILABLE IN MOTTLED
TAMBIÉN DISPONIBLE EN MATIZADO
AUSSI DISPONIBLE EN NUANCÉ

| | | | |
|------|----------------------------------|------------|--------|
| 87 | Fuga coroa em brita | 50x30x32cm | 32Kg |
| 88 | Fuga coroa em brita | 31x31x32cm | 32Kg |
| 117 | Fuga coroa envelhecida cinza (1) | 33x26x25cm | 15Kg |
| 117A | Fuga coroa envelhecida amarela | 33x26x25cm | 15Kg |
| 118 | Fuga coroa | 32x32x32cm | 32Kg |
| 170 | Fuga coroa s/ tampa | 32x32x25cm | 25Kg |
| 292 | Fuga coroa grande | 50x30x32cm | 39Kg |
| 293 | Fuga coroa grande s/ tampa | 50x30x25cm | 27Kg |
| 733 | Fuga ventilada | 31x31x30cm | 18Kg |
| 86 | Fuga em brita | 50x30x25cm | 30Kg |
| 190 | Fuga média | 30x30x20cm | 15Kg |
| 97 | Fuga grande | 50x30x20cm | 25Kg |
| 99 | Fuga em brita mini | 30x30x25cm | 18Kg |
| 113 | Fuga em brita pequena | 31x31x31cm | 32Kg |
| 114 | Fuga em brita média | 62x31x31cm | 44Kg |
| 247 | Fuga envelhecida cinza | 33x26x25cm | 15Kg |
| 247A | Fuga envelhecida amarela (2) | 33x26x25cm | 15Kg |
| 132 | Fuga imitação pedra | 34x34x31cm | 32Kg |
| 245 | Fuga imitação tijolo | 31x31x26cm | 28Kg |
| 299 | Fuga cimento vibrado média | 30x30x30cm | 18Kg |
| 81 | Fuga Maxi | 65x31x31cm | 17,5Kg |
| 82 | Fuga Midi | 80x31x35cm | 60Kg |
| 83 | Fuga Mini | 60x45x20cm | 34Kg |



ref. 87, 88



ref. 117 (1)



ref. 118, 170



ref. 292, 293



ref. 733



ref. 86



ref. 190, 97



ref. 113, 99



ref. 114



ref. 247A (2)



ref. 132



ref. 245 (3)



ref. 299



ref. 81



ref. 82



ref. 83

VENTILADORES E CHAMINÉS

VENTILATORS AND CHIMNEYS
VENTILADORES Y CHIMENEAS
VENTILATEURS ET CHEMINÉES

| | | | |
|------|------------------------|-------------|------|
| 191 | Ventilador | 38x38x20cm | 27Kg |
| 191B | Ventilador branco | 38x38x20cm | 27Kg |
| 253 | Ventilador | 70x60x22cm | 59Kg |
| 254 | Ventilador | 75x75x26cm | 67Kg |
| 255 | Ventilador | 85x115x29cm | 75Kg |
| 562 | Ventilador | 70x40x21cm | 34Kg |
| 249 | Ventilador Envelhecido | 37x37x29cm | 17Kg |
| 248 | Chaminé | 35x35x77cm | 31Kg |



VENTILADORES DISPONÍVEIS EM VÁRIOS TAMANHOS
VENTILATORS AVAILABLE IN VARIOUS SIZES
VENTILADORES DISPONIBLES EN VARIOS TAMAÑOS
VENTILATEURS DISPONIBLE DANS DIVERS TAILLES



ref. 249



ref. 248



ref. 191

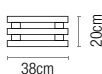

ref. 253



ref. 254

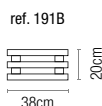

ref. 191B



ref. 255



ref. 562

ACESSÓRIOS DE FORNO

OVEN ACCESSORIES . ACCESORIOS DE HORNO . ACCESSOIRES DE FROUS

| | | | |
|-----|---|-----------|---------|
| 519 | Termómetro c/ vareta | - | 0,650Kg |
| 902 | Espeto p/ forno 80 | 80cm | - |
| 903 | Espeto p/ forno 90 e 100 | 100cm | - |
| 904 | Espeto p/ forno 110 e 120 | 120cm | - |
| 994 | Chaminé em inox c/ chapéu | Ø15x115cm | - |
| 995 | Pá em inox | - | - |
| 996 | Rodo em inox | - | - |
| 999 | Conjunto de 4 acessórios (pá, rodo, vassoura e forcado) | - | - |



ref. 519

ref. 902, 903, 904



ref. 999



ref. 994



ref. 996



ref. 995

FORNOS

OVENS
HORNOs
FROUS



ref. 1, 2, 3, 4, 5



forno também disponível sem canga



ref. 11, 12, 13, 15, 16

| | | | |
|----|------------------------------------|-----------|-------|
| 1 | Forno c/ canga e c/ tubo | 80x80cm | 350Kg |
| 2 | Forno c/ canga e c/ tubo | 90x90cm | 450Kg |
| 3 | Forno c/ canga e c/ tubo | 100x100cm | 600Kg |
| 4 | Forno c/canga e c/tubo | 110x110cm | 700Kg |
| 5 | Forno c/ canga e c/ tubo | 120x120cm | 800Kg |
| 11 | Forno c/ parede e porta de fumeiro | 80x80cm | 376Kg |
| 12 | Forno c/ parede e porta de fumeiro | 90x90cm | 476Kg |
| 13 | Forno c/ parede e porta de fumeiro | 100x100cm | 626Kg |
| 15 | Forno c/ parede e porta de fumeiro | 120x120cm | 831Kg |
| 16 | Forno c/ parede e porta de fumeiro | 110x110cm | 731Kg |
| 18 | Forno de pizza | 100x100cm | 600Kg |
| 19 | Forno de pizza | 110x110cm | 700Kg |
| 20 | Forno de pizza | 120x120cm | 800Kg |

As medidas apresentadas são exteriores. por dentro são \pm -20cm.



FORNOS DISPONÍVEIS EM VÁRIOS TAMANHOS
OVENS AVAILABLE IN VARIOUS SIZES
HORNOs DISPONIBLES EN VARIOS TAMAÑOS
FOURS DISPONIBLE DANS DIVERS TAILLES



ref. 18, 19, 20



MATERIAL URBANO

URBAN MATERIAL
MATERIAL URBANO
URBAN MATÉRIAL

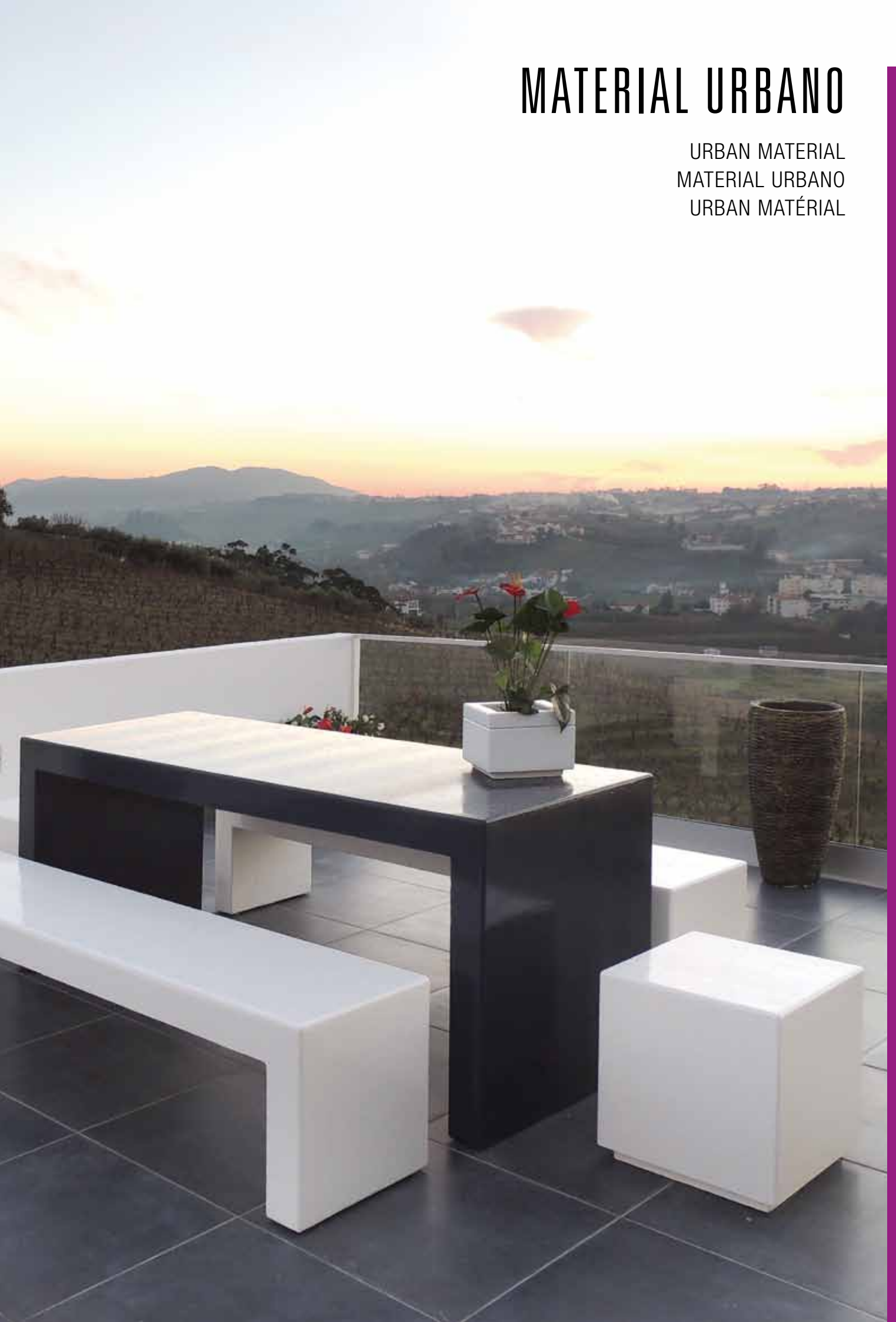



BETÃO NATURAL BRANCO/CINZA OU PINTADO BRANCO/ANTRACITE
 NATURAL WHITE/GRAY CONCRETE OR WHITE/ANTHRACITE PAINTED
 HORMIGÓN NATURAL BLANCO/GRIS O PINTADO BLANCO/ANTRACITA
 BÉTON NATUREL BLANC/GRIS OU PEINT BLANC/ANTHRACITE



ref. 989



ref. 581



ref. 959

MESAS E BANCOS . TABLES AND BENCHES . MESAS Y BANCOS . TABLES ET BANCOS

| | | | |
|-----|-------------------------------|--------------|--------|
| 989 | Mesa Urban com rodas | 90x90x35cm | 160Kg |
| 581 | Conjunto Urban retangular (1) | 200x80x80cm* | 1120Kg |
| 388 | Mesa Urban | 200x80x80cm | 600Kg |
| 364 | Banco Mega | 200x45x45cm | 260Kg |
| 959 | Conjunto urbano quadrado (1) | 85x85x83cm* | 367Kg |
| 934 | Mesa quadrada Urban | 85x85x83cm | 235Kg |
| 366 | Banco Cubo | 45x45x45cm | 132Kg |
| 921 | Banco Mega com costas (2) | 200x45x45cm | 445Kg |
| 928 | Costas banco Urban | 155x10x88cm | 185Kg |
| 919 | Banco Ox com costas (2) | 200x45x45cm | 550Kg |
| 365 | Banco Ox | 200x45x45cm | 365Kg |
| 918 | Banco com bola com costas (2) | 220x46x46cm | 520Kg |
| 929 | Banco com bola | 220x46x46cm | 335Kg |

* medidas das mesas



(1) TAMBÉM DISPONÍVEL EM PEÇAS INDIVIDUAIS
 ALSO AVAILABLE IN INDIVIDUAL PIECES
 TAMIÉN DISPONIBLE EN PIEZAS INDIVIDUALES
 AUSSI DISPONIBLE EN PIÈCES INDIVIDUELS



BETÃO NATURAL BRANCO/CINZA OU PINTADO BRANCO/ANTRACITE
 NATURAL WHITE/GRAY CONCRETE OR WHITE/ANTHRACITE PAINTED
 HORMIGÓN NATURAL BLANCO/GRIS O PINTADO BLANCO/ANTRACITA
 BÉTON NATUREL BLANC/GRIS OU PEINT BLANC/ANTHRACITE

 (2) TAMBÉM DISPONÍVEL SEM COSTAS
 ALSO AVAILABLE WITHOUT BACK
 TAMIÉN DISPONIBLE SIN ESPALDA
 AUSSI DISPONIBLE SANS DOS



ref. 919



ref. 918



ref. 921



ref. 922

CHAFARIZ . FOUNTAINS . FUENTES . FONTAINES

| | | | |
|-----|----------------------------------|------------|-------|
| 922 | Chafariz Mega com base URBAN (1) | 85x85x91cm | 350Kg |
| 930 | Chafariz Mega URBAN | 46x46x83cm | 220Kg |
| 361 | Bebedouro em betão URBAN | 40x40x75cm | 134Kg |
| 931 | Base para chafariz URBAN | 85x85x8cm | 130Kg |

 (1) TAMBÉM DISPONÍVEL EM PEÇAS INDIVIDUAIS
 ALSO AVAILABLE IN INDIVIDUAL PIECES
 TAMIÉN DISPONIBLE EN PIEZAS INDIVIDUALES
 AUSSI DISPONIBLE EN PIÈCES INDIVIDUELS



ref. 930



ref. 931



ref. 361



 ACABAMENTO POSSÍVEL
 POSSIBLE FINISH
 ACABAMIENTO POSIBLE
 FINITION POSSIBLE



BETÃO NATURAL BRANCO/CINZA OU PINTADO BRANCO/ANTRACITE
 NATURAL WHITE/GRAY CONCRETE OR WHITE/ANTHRACITE PAINTED
 HORMIGÓN NATURAL BLANCO/GRIS O PINTADO BLANCO/ANTRACITA
 BÉTON NATUREL BLANC/GRIS OU PEINT BLANC/ANTHRACITE



ref. 923



ref. 927



ref. 362



ACABAMENTOS POSSÍVEIS
 POSSIBLE FINISHES
 ACABAMIENTOS POSIBLES
 FINITIONS POSSIBLES

CINZEIROS / PAPELEIRAS

| | | | |
|-----|---------------------------|------------|-------|
| 923 | Cinzeiro Urbano completo | 50x50x93cm | 160Kg |
| 927 | Papeleira com base e inox | 50x50x93cm | 135Kg |
| 362 | Papeleira em betão | 40x40x90cm | 122Kg |

VASOS . VASES . VASOS . VASES

| | | | |
|------|-----------------------------|---------------|-------|
| 366A | Vaso Urban | 45x45x45cm | 99Kg |
| 640 | Floreira Urban Barco | 140x70x60cm | 220Kg |
| 650 | Vaso Urban quadrado gigante | 120x120x100cm | 360Kg |

LIMITADORES

| | | | |
|-----|-------------------------|------------|-------|
| 233 | Pilar de Vedação | 35x35x74cm | 120Kg |
| 236 | Bola sem base pequena | Ø30cm | 25Kg |
| 237 | Bola sem base média | Ø40cm | 52Kg |
| 238 | Bola sem base grande | Ø50cm | 94Kg |
| 925 | Limitador Urban Pequeno | Ø22x45cm | 19Kg |
| 926 | Limitador Urban Grande | Ø52x84cm | 130Kg |



ref. 640



ref. 366A



ref. 650



ref. 233



ref. 236

ref. 237

ref. 238



ref. 925



ref. 926



VASOS E FLOREIRAS

VASES AND PLANTS STANDS
VASOS Y JARDINERAS
VASES ET POTS DE FLEURS

DÉCOR

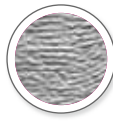

BRANCO OU ANTRACITE
WHITE OR ANTHRACITE
BLANCO O ANTRACITA
BLANC OU ANTHRACITE



ref. G1253

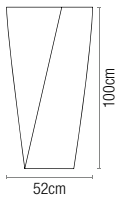

ref. G1255

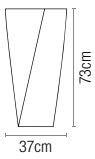

ref. G1254

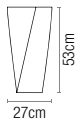

ref. G1257

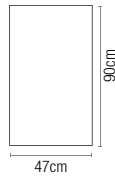

ref. G1258

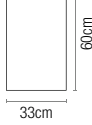

ref. G1256



ref. G1259



ref. G1260

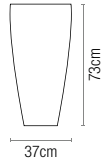

ref. 945

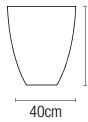

ref. 944

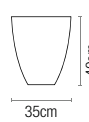

ref. 943

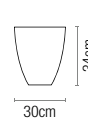

ref. 947

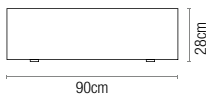

ref. 946

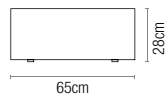

| | | | |
|-------|-----------------------------------|------------|-------|
| G1253 | Vaso decor quadrado grande | 52x100cm | 210Kg |
| G1255 | Vaso decor quadrado médio | 37x73cm | 90Kg |
| G1254 | Vaso decor quadrado pequeno | 27x53cm | 37Kg |
| G1256 | Vaso decor torcido médio | 33x33x96cm | 176Kg |
| G1257 | Vaso decor quadrado largo grande | 47x47x90cm | 220Kg |
| G1258 | Vaso decor quadrado largo médio | 33x33x60cm | 115Kg |
| G1259 | Vaso decor redondo grande | Ø51x70cm | 100Kg |
| G1260 | Vaso decor redondo médio | Ø37x73cm | 78Kg |
| 943 | Vaso texturado branco pequeno | 30x30x34cm | 19Kg |
| 944 | Vaso texturado branco médio | 35x35x40cm | 25Kg |
| 945 | Vaso texturado branco grande | 40x40x46cm | 35Kg |
| 946 | Floreira texturada branca pequena | 65x25x28cm | 42Kg |
| 947 | Floreira texturada branca grande | 90x25x28cm | 54Kg |





ref. 454

ref. 453

ref. 452

ref. 628

ref. 627

ref. 470

ref. 469

ref. 468

ref. 649

ref. 648

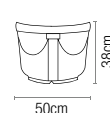
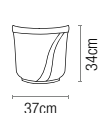
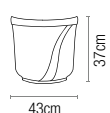
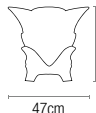
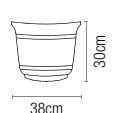
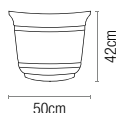

ref. 612

ref. 611

ref. 610

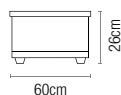
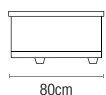
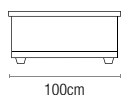

| | | | |
|-----|---|-------------|-------|
| 454 | Vaso de anjos grande (1) | Ø50x42cm | 30Kg |
| 453 | Vaso de anjos médio (1) | Ø38x30cm | 15Kg |
| 452 | Vaso de anjos pequeno (1) | Ø30x21cm | 8Kg |
| 628 | Vaso c/ pés grande (1) | 47x47x50cm | 47Kg |
| 627 | Vaso c/ pés pequeno (1) | 36x36x41cm | 23Kg |
| 470 | Vaso de risca grande (1) | Ø43x37cm | 24Kg |
| 469 | Vaso de risca médio (1) | Ø37x34cm | 17Kg |
| 468 | Vaso de risca pequeno (1) | Ø31x27cm | 11Kg |
| 649 | Vaso franja grande (1) | Ø50x38cm | 57Kg |
| 648 | Vaso franja pequeno (1) | Ø40x30cm | 40Kg |
| 612 | Floreira Canastrada grande (1) | 100x20x26cm | 33Kg |
| 611 | Floreira Canastrada média (1) | 80x20x26cm | 23Kg |
| 610 | Floreira Canastrada pequena (1) | 60x20x26cm | 20Kg |
| 514 | Conjunto vaso de pé grande + pé (2) | Ø62x138cm | 230Kg |
| 513 | Conjunto vaso de pé pequeno + pé (2) | Ø48x109cm | 117Kg |
| 198 | Conjunto vaso quadrado grande + pé (2) | 68x68x123cm | 318Kg |
| 199 | Conjunto vaso quadrado pequeno + pé (2) | 52x52x102cm | 160Kg |
| 102 | Pé grande | 45x45x65cm | 88Kg |
| 108 | Pé pequeno | 39x39x56cm | 57Kg |
| 626 | Vaso de pé grande | Ø62x72cm | 142Kg |
| 625 | Vaso de pé pequeno | Ø48x53cm | 60Kg |
| 100 | Vaso quadrado grande | 68x68x58cm | 230Kg |
| 103 | Vaso quadrado pequeno | 52x52x44cm | 103Kg |



(2) TAMBÉM DISPONÍVEL EM PEÇAS INDIVIDUAIS . ALSO AVAILABLE IN INDIVIDUAL PIECES
TAMBIÉN DISPONIBLE EN PIEZAS INDIVIDUALES . AUSSI DISPONIBLE EN PIÈCES INDIVIDUELLES

ref. 514

ref. 513

ref. 198

ref. 199

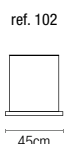
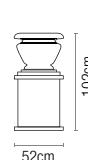
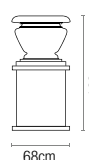
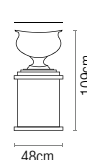
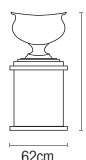



A



A



B



C



D



BARRO, PRETO, BRANCO OU ANTRACITE
CLAY, BLACK, WHITE OR ANTHRACITE
BARRO, NEGRO, BLANCO O ANTHRACITA
ARGILE, NOIR, BLANC OU ANTHRACITE



E



F



G



H



L

J

J, L
PEÇAS SEM FUNDO
BOTTOMLESS PIECES
PIEZAS SIN FONDO
PIÈCES SANS FOND



TAMBÉM DISPONÍVEL EM BRANCO
ALSO AVAILABLE IN WHITE
TAMBIÉN DISPONIBLE EN BLANCO
AUSSI DISPONIBLE EN BLANC



I

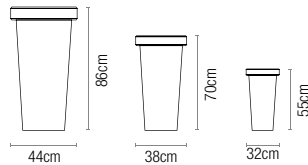

| | | | |
|---|----------|----------|----------|
| A | ref. 647 | ref. 646 | ref. 645 |
| B | ref. 643 | ref. 642 | ref. 641 |
| C | ref. 674 | ref. 675 | ref. 676 |
| D | ref. 697 | ref. 696 | ref. 695 |

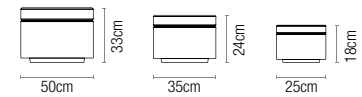

| | | | |
|---|-----------|-----------|-----------|
| E | ref. 691 | ref. 690 | ref. 689 |
| F | ref. 688 | ref. 687 | ref. 686 |
| G | ref. 679 | ref. 678 | ref. 677 |
| H | ref. 685 | ref. 684 | ref. 683 |
| I | ref. 685p | ref. 684p | ref. 683p |

| | | | |
|--------------------------|--------------------------------|------------|------|
| 645, 641, 676, 695 | Vaso alto pequeno | 32x32x55cm | 29Kg |
| 646, 642, 675, 696 | Vaso alto médio | 38x38x70cm | 46Kg |
| 643, 647, 674, 697 | Vaso alto grande | 44x44x86cm | 65Kg |
| 689, 686, 677, 683, 683P | Vaso quadrado pequeno | 25x25x18cm | 11Kg |
| 690, 687, 678, 684, 684P | Vaso quadrado médio | 35x35x24cm | 24Kg |
| 691, 688, 679, 685, 685P | Vaso quadrado grande | 50x50x33cm | 58Kg |
| 680, 692 | Vaso quadrado pequeno s/ fundo | 25x25x14cm | 7Kg |
| 681, 693 | Vaso quadrado médio s/ fundo | 35x35x18cm | 13Kg |
| 682, 694 | Vaso quadrado grande s/ fundo | 50x50x25cm | 29Kg |
| 740 | Pote pequeno | Ø50x54 | 45Kg |
| 741 | Pote médio | Ø60x65 | 66Kg |
| 742 | Pote grande | Ø70x76 | 87Kg |

Opção de conjugação de cores.
Opção de vaso composto por elementos em todos os tamanhos.
Possibility of combining colors.
Vase option composed by elements in all sizes.

Opción de conjugar colores.
Opción de vaso compuesto por elementos en todos los tamaños.
Option de conjugaison de couleurs.
Option de pots composés d'éléments en toutes les tailles.

A, L - preto/barro . black/clay . negro/barro . noir/argile
B, F - barro/preto . clay/black . barro/negro . argile/noir
C, G, J - barro . clay . barro . argile
D, H, L - preto . black . negro . noir
I - branco . white . blanco . blanc



ref. 742



ref. 741



ref. 740



LISOS



BRITA, GRANITO OU MARMORITE BRANCO
GRAVEL, GRANITE OR WHITE GRAVEL
GRAVA, GRANITO OU MARMORITE BLANCO
GRAVIER, GRANITE OU GRAVIER BLANC

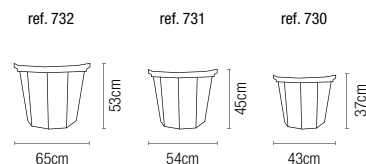
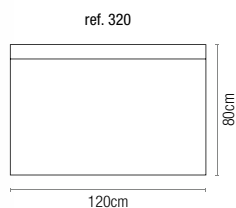
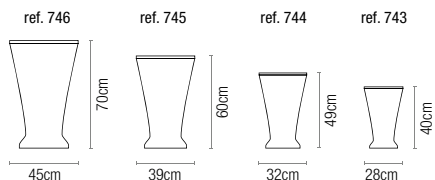
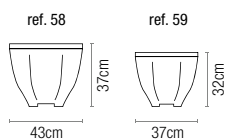
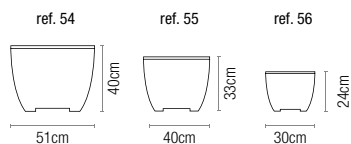

| | | | |
|-----|-----------------------------|-------------|--------|
| 54 | Vaso liso quadrado grande | 51x51x40cm | 40Kg |
| 55 | Vaso liso quadrado médio | 40x40x33cm | 30Kg |
| 56 | Vaso liso quadrado pequeno | 30x30x24cm | 26Kg |
| 58 | Vaso liso sextavado grande | Ø43x37cm | 21Kg |
| 59 | Vaso liso sextavado pequeno | Ø37x32cm | 15Kg |
| 746 | Vaso ânforas gigante | 45x45x70cm | 56Kg |
| 745 | Vaso ânforas grande | 39x39x60cm | 40Kg |
| 744 | Vaso ânforas médio | 32x32x49cm | 28Kg |
| 743 | Vaso ânforas pequeno | 28x28x40cm | 15Kg |
| 320 | Floreira Urban | 120x30x80cm | 125Kg |
| 221 | Vaso cilindro grande | Ø72x51cm | 104Kg |
| 222 | Vaso cilindro gigante | Ø85x73cm | 210Kg |
| 101 | Vaso cilindro grande | Ø59x45cm | 74Kg |
| 112 | Vaso cilindro médio | Ø49x37cm | 35Kg |
| 111 | Vaso cilindro pequeno | Ø39x30cm | 19Kg |
| 110 | Vaso cilindro mini | Ø31x24cm | 10Kg |
| 371 | Vaso quadrado grande | 56x56x48cm | 113Kg |
| 370 | Vaso quadrado médio | 46x46x39cm | 61Kg |
| 369 | Vaso quadrado pequeno | 35x35x30cm | 22Kg |
| 368 | Vaso quadrado mini | 31x31x23cm | 14Kg |
| 308 | Vaso copo | Ø61x61cm | 88Kg |
| 323 | Floreira lisa gigante maxi | 140x45x59cm | 220Kg |
| 321 | Floreira lisa gigante | 120x45x59cm | 190Kg |
| 324 | Floreira lisa grande | 120x30x36cm | 94Kg |
| 325 | Floreira lisa média | 90x30x36cm | 70Kg |
| 322 | Floreira lisa pequena | 60x30x34cm | 32Kg |
| 732 | Vaso oitavado grande | 65x53cm | 57Kg |
| 731 | Vaso oitavado médio | 54x45cm | 22Kg |
| 730 | Vaso oitavado pequeno | 43x37cm | 14,5Kg |



ref. 221

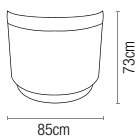

ref. 222

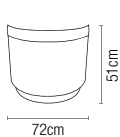

ref. 101

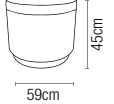

ref. 112

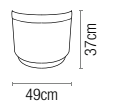

ref. 111

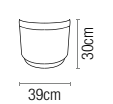

ref. 110



ref. 308

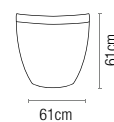

ref. 371

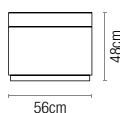

ref. 370

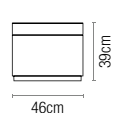

ref. 369

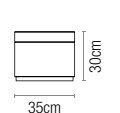

ref. 368

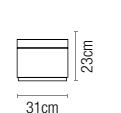

ref. 323

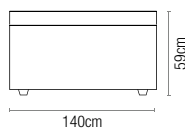

ref. 321

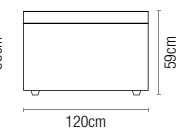

ref. 324

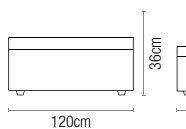

ref. 325

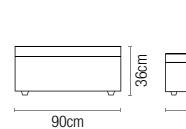

ref. 322

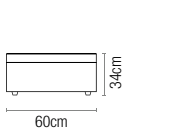

TÚLIPAS

| | | | |
|-----|-------------------------|-------------|------|
| 633 | Floreira Tulipa grande | 101x25x33cm | 52Kg |
| 632 | Floreira Tulipa média | 81x25x33cm | 44Kg |
| 631 | Floreira Tulipa pequena | 61x25x33cm | 32Kg |
| 472 | Vaso Tulipa grande | Ø38x36cm | 23Kg |
| 471 | Vaso Tulipa pequeno | Ø30x25cm | 20Kg |

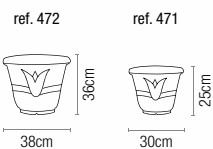
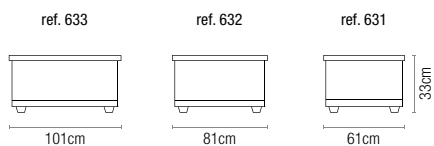

FLORES



ref. 401

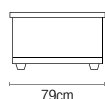

ref. 409

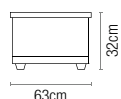

ref. 449

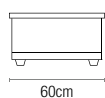

ref. 450

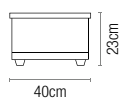

ref. 601

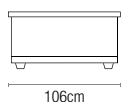

ref. 602

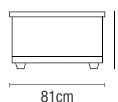

ref. 620

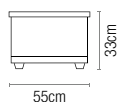

| | | | |
|-----|------------------------------|-------------|------|
| 401 | Floreira flores grande | 79x26x32cm | 41Kg |
| 409 | Floreira flores pequena | 63x26x32cm | 34Kg |
| 449 | Floreira flor fina grande | 60x16x23cm | 14Kg |
| 450 | Floreira flor fina pequena | 40x16x23cm | 10Kg |
| 601 | Floreira flores grande | 106x27x33cm | 50Kg |
| 602 | Floreira flores média | 81x27x33cm | 35Kg |
| 620 | Floreira flores pequena | 55x27x33cm | 27Kg |
| 467 | Vaso redondo flores mini | Ø35x28cm | 20Kg |
| 606 | Vaso redondo flores grande | Ø49x43cm | 45Kg |
| 604 | Vaso redondo flores pequeno | Ø39x32cm | 23Kg |
| 605 | Vaso quadrado flores grande | 44x44x44cm | 65Kg |
| 603 | Vaso quadrado flores pequeno | 35x35x33cm | 26Kg |
| 502 | Vaso de pé c/flores grande | Ø43x55cm | 34Kg |
| 501 | Vaso de pé c/flores pequeno | Ø34x43cm | 18Kg |



ref. 467

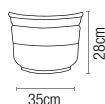

ref. 606

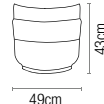

ref. 604

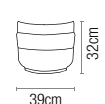

ref. 605

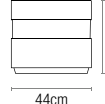

ref. 603

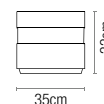

ref. 502



ref. 501



CANELADOS



ref. 518

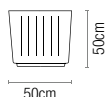

ref. 517



ref. 105

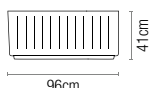

ref. 109

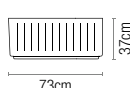

ref. 106

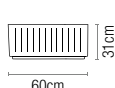

ref. 867

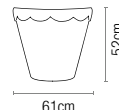

ref. 866

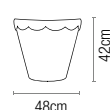

ref. 865



ref. 671



ref. 670



ref. 673



ref. 672



ref. 635

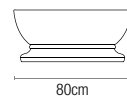

ref. 634

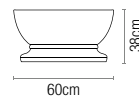

ref. 639

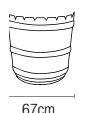

ref. 638

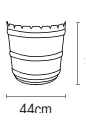

ref. 637



ref. 636

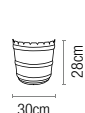

| | | | |
|-----|-------------------------------------|------------|--------|
| 518 | Vaso quadrado canelado grande | 50x50x50cm | 68Kg |
| 517 | Vaso quadrado canelado pequeno | 39x39x40cm | 34Kg |
| 671 | Vaso c/pé redondo canelado grande | Ø40x42cm | 31Kg |
| 670 | Vaso c/pé redondo canelado pequeno | Ø31x35cm | 18Kg |
| 673 | Vaso c/pé quadrado canelado grande | 31x31x38cm | 23Kg |
| 672 | Vaso c/pé quadrado canelado pequeno | 26x26x32cm | 15Kg |
| 105 | Floreira canelada grande | 96x33x41cm | 95Kg |
| 109 | Floreira canelada média | 73x28x37cm | 69Kg |
| 106 | Floreira canelada pequena | 60x23x31cm | 41Kg |
| 635 | Floreira canelada com pé grande | 80x30x38cm | 57Kg |
| 634 | Floreira canelada com pé pequena | 60x30x38cm | 45Kg |
| 867 | Vaso redondo c/ franja grande (1) | Ø61x52cm | 67Kg |
| 866 | Vaso redondo c/ franja médio (1) | Ø48x42cm | 38Kg |
| 865 | Vaso redondo c/ franja pequeno (1) | Ø37x32cm | 19,5Kg |
| 639 | Vaso barrica gigante | Ø67x63cm | 117Kg |
| 638 | Vaso barrica grande | Ø44x48cm | 60Kg |
| 637 | Vaso barrica médio | Ø34x33cm | 20Kg |
| 636 | Vaso barrica pequeno | Ø30x28cm | 8Kg |



TRIÂNGULOS

| | | | |
|-----|------------------------------------|------------|-------|
| 609 | Floreira triângulos grande | 86x25x29cm | 32Kg |
| 616 | Floreira triangulos pequena | 65x25x29cm | 25Kg |
| 607 | Vaso canto triângulos | 37x37x28cm | 22Kg |
| 202 | Conjunto pé c/ vaso triângulos (1) | 37x37x77cm | 53Kg |
| 608 | Vaso quadrado triângulos | 37x37x33cm | 26Kg |
| 201 | Conjunto pé c/ vaso triângulos (1) | Ø55x122cm | 100Kg |
| 613 | Vaso redondo triângulos grande | Ø55x45cm | 46Kg |
| 615 | Vaso redondo triângulos médio | Ø47x36cm | 23Kg |
| 614 | Vaso redondo triângulos pequeno | Ø39x26cm | 13Kg |



(1) TAMBÉM DISPONÍVEL EM PEÇAS INDIVIDUAIS . ALSO AVAILABLE IN INDIVIDUAL PIECES
TAMBIÉN DISPONIBLE EN PIEZAS INDIVIDUALES . AUSSI DISPONIBLE EN PIÈCES INDIVIDUELS



ref. 609

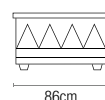

ref. 616

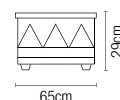

ref. 607

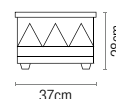

ref. 202

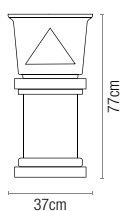

ref. 608

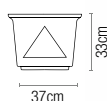

ref. 201

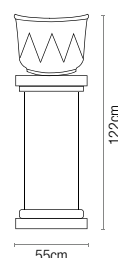

ref. 613



ref. 615

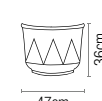

ref. 614



BACIAS

| | | | |
|-----|----------------|-----------|------|
| 104 | Bacia Canelada | Ø71x31cm | 65Kg |
| 451 | Bacia média | Ø51x23cm | 22Kg |
| 455 | Bacia mini | Ø38x17cm | 11Kg |
| 252 | Bacia Gigante | Ø110x26cm | 99Kg |



ref. 104

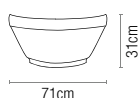

ref. 451

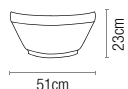

ref. 455

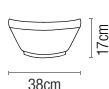

ref. 252

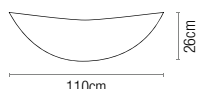

PRATOS

| | | | |
|-----|-----------------------|-----------|-------|
| 657 | Prato redondo gigante | Ø59x9cm | 11Kg |
| 655 | Prato redondo grande | Ø43x8cm | 9Kg |
| 654 | Prato redondo médio | Ø40x8cm | 9Kg |
| 653 | Prato redondo pequeno | Ø32x7cm | 5Kg |
| 652 | Prato redondo mini | Ø27x7cm | 4Kg |
| 656 | Prato quadrado | 37x37x8cm | 7,5Kg |



ref. 656



ref. 657

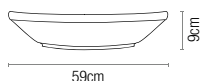

ref. 655

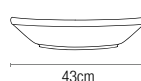

ref. 654

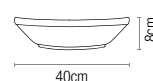

ref. 653

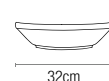

ref. 652





MESAS E BANCOS

TABLE AND BENCHES
MESAS Y BANCOS
TABLE ET BANCS

| | | | |
|-----|----------------------------------|---------------|-------|
| 561 | Cadeira castanha | - | - |
| 536 | Cadeira branca | - | - |
| 777 | Conjunto sextavado c/ 6 cadeiras | 133x133x79cm* | 260Kg |
| 778 | Conjunto sextavado c/ 3 cadeiras | 133x133x79cm* | 240Kg |
| 780 | Conjunto redondo c/ 5 cadeiras | Ø118x79cm* | 260Kg |
| 781 | Conjunto redondo c/ 4 cadeiras | Ø118x79cm* | 240Kg |

* medidas das mesas



CADEIRA BRANCA OU CASTANHA
CHAIR WHITE OR BROWN
SILLA BLANCA O CASTANHA
CHAISE BLANC OU MARRON



ref. 536



ref. 561



ref. 777



ref. 781





ref. 493



ref. 473



MESAS E BANCOS DISPONÍVEIS EM VÁRIOS TAMANHOS E FORMATOS
 TABLES AND BENCHES AVAILABLE IN VARIOUS SIZES AND SHAPES
 MESAS Y BANCOS DISPONIBLES EN VARIOS TAMAÑOS Y FORMAS
 TABLES ET BANCOS DISPONIBLES DANS DIMENSIONS ET FORMES DIVERSES

MESAS . TABLES . MESAS . TABLES



160x85x78cm
135x85x78cm



175x85x78cm

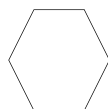

135x135x78cm

BANCOS . BENCHES . BANCOS . BANCOS



50x38x48cm

130x38x48cm

PEÇAS COM RISCA

| | | | |
|-----|---------------------------------|---------------|-------|
| 492 | Conjunto retangular c/ 4 bancos | 135x85x78cm* | 495Kg |
| 493 | Conjunto retangular c/ 2 bancos | 135x85x78cm* | 425Kg |
| 496 | Conjunto retangular c/ 4 bancos | 160x85x78cm* | 571Kg |
| 497 | Conjunto retangular c/ 2 bancos | 160x85x78cm* | 465Kg |
| 494 | Conjunto oval c/ 4 bancos | 175x85x78cm* | 591Kg |
| 495 | Conjunto oval c/ 2 bancos | 175x85x78cm* | 515Kg |
| 490 | Conjunto sextavado c/ 6 bancos | 135x135x78cm* | 485Kg |
| 491 | Conjunto sextavado c/ 3 bancos | 135x135x78cm* | 371Kg |
| 250 | Banco individual | 50x38x48cm | 38Kg |
| 251 | Banco retangular | 130x38x48cm | 92Kg |

PEÇAS COM RISCA E COM FLOR

| | | | |
|-----|---------------------------------|---------------|-------|
| 460 | Conjunto retangular c/ 2 bancos | 135x85x78cm* | 425Kg |
| 461 | Conjunto retangular c/ 4 bancos | 135x85x78cm* | 495Kg |
| 462 | Conjunto retangular c/ 2bancos | 160x85x78cm* | 465Kg |
| 463 | Conjunto retangular c/ 4 bancos | 160x85x78cm* | 571Kg |
| 464 | Conjunto oval c/ 2 bancos | 175x85x78cm* | 515Kg |
| 465 | Conjunto oval c/ 4 bancos | 175x85x78cm* | 591Kg |
| 473 | Conjunto sextavado c/ 3 bancos | 135x135x78cm* | 371Kg |
| 474 | Conjunto sextavado c/ 6 bancos | 135x135x78cm* | 485Kg |
| 414 | Banco individual | 50x38x48cm | 38Kg |
| 415 | Banco retangular | 130x38x48cm | 92Kg |

* medidas das mesas



BANCOS DISPONÍVEIS EM 2 FORMATOS
BENCHES AVAILABLE IN 2 SHAPES
MESAS Y BANCOS DISPONIBLES EN 2 FORMAS
TABLES ET BANCOS DISPONIBLES DANS 2 FORMES



ref. 924,1



ref. 889,1



ref. 900,1



ref. 551



ref. 917,1



| | | | |
|-------|--|---------------|-------|
| 924,1 | Conjunto oval liso c/ 4 bancos c/ costas | 200x88x75cm* | 972Kg |
| 889,1 | Banco meia lua liso c/ costas | 150x43x83cm | 179Kg |
| 900,1 | Banco retangular liso c/ costas | 147x65x83cm | 179Kg |
| 551 | Conjunto artedubai c/ 2 bancos | 250x110x80cm* | 766Kg |
| 917,1 | Conjunto flor c/ 3 bancos | Ø135x75cm* | 560Kg |

* medidas das mesas



ref. 327



| | | | |
|------|--------------------------------------|--------------|-------|
| 326 | Conjunto oval c/ 2 bancos | 200x85x78cm* | 516Kg |
| 327 | Conjunto oval c/ 4 bancos | 200x85x78cm* | 710Kg |
| 336 | Conjunto redondo liso c/ 6 bancos | Ø160x78cm* | 509Kg |
| 348 | Conjunto redondo liso c/ 5 bancos | Ø130x78cm* | 403Kg |
| 349 | Conjunto redondo liso c/ 5 bancos | Ø110x78cm* | 341Kg |
| 400A | Conjunto redondo liso c/ 3 bancos | Ø160x78cm* | 565Kg |
| 317 | Conjunto redondo liso c/ 3 bancos | Ø130x78cm* | 499Kg |
| 318 | Conjunto redondo liso c/ 3 bancos | Ø110x78cm* | 470Kg |
| 319 | Conjunto retangular liso c/ 2 bancos | 180x80x78cm* | 506Kg |
| 329 | Conjunto retangular liso c/ 2 bancos | 165x75x78cm* | 455Kg |
| 330 | Conjunto retangular liso c/ 2 bancos | 140x75x78cm* | 419Kg |
| 331 | Conjunto retangular liso c/ 2 bancos | 125x75x78cm* | 365Kg |
| 335 | Banco retangular liso | 165x38x48cm | 123Kg |
| 334 | Banco retangular liso | 155x35x48cm | 100Kg |
| 333 | Banco retangular liso | 130x33x48cm | 92Kg |
| 332 | Banco retangular liso | 120x32x48cm | 88Kg |
| 174 | Banco meia lua liso | 135x38x48cm | 97Kg |

* medidas das mesas



MESAS E BANCOS DISPONÍVEIS EM VÁRIOS TAMANHOS E FORMATOS
TABLES AND BENCHES AVAILABLE IN VARIOUS SIZES AND SHAPES
MESAS Y BANCOS DISPONIBLES EN VARIOS TAMAÑOS Y FORMAS
TABLES ET BANCOS DISPONIBLES DANS DIMENSIONS ET FORMES DIVERSES

MESAS . TABLES . MESAS . TABLES



200x85x78cm

160Øx78cm
130Øx78cm
110Øx78cm180x80x78cm
165x75x78cm
140x75x78cm
125x75x78cm

BANCOS . BENCHES . BANCOS . BANCS

165x38x48cm
155x35x48cm
130x33x48cm
120x32x48cm

135x38x48cm



ref. 844



ref. 307



ref. 363



ref. 312



ref. 314

| | | | |
|-----|---------------------------|--------------|-------|
| 844 | Conjunto a imitar madeira | 150x73x82cm* | 230Kg |
| 307 | Banco liso c/ 2 vasos | 235x50x55cm | 305Kg |
| 363 | Banco Romano | 330x70x235cm | 950Kg |
| 312 | Banco liso c/ costas | 190x63x95cm | 360Kg |
| 314 | Banco liso s/ costas | 190x60x56cm | 195Kg |





BASES DE CHAPÉUS

UMBRELLA STANDS
BASES PARA SOMBREROS
BASES POUR DES PARASOLS



ref. 390



ref. 391



ref. 392



ref. 920



ref. 161



ref. 353



ref. 162



ref. 357



ref. 783



ref. 784



ref. 798

ref. 345



ref. 346



ref. 347



ref. 786



ref. 785



ref. 991 (2)



ref. 992



TUBO . PIPE
TUBO . TUBE UN.
PALETTE

PLÁSTICO E BETÃO . RESINE AND CONCRETE . RESINA Y HORMIGÓN . RÉSINE ET BÉTON

| REF. | DESCRIPTION | SIZE | WEIGHT | PIPE Ø | UNITS |
|------|------------------------------------|------------|--------|----------|-------|
| 390 | Base plástico e betão pequena | Ø39x9cm | 18Kg | Ø18a38mm | 60 |
| 391 | Base plástico e betão grande | Ø47x9cm | 28Kg | Ø18a55mm | 40 |
| 392 | Base plástico e betão quadrada | 46x48x10cm | 39Kg | Ø18a55mm | 40 |
| 920 | Base plástico e betão grande preto | Ø47x9cm | 28Kg | Ø18a55mm | 40 |

BRITA . GRAVEL . GRAVA . GRAVIER

| | | | | | |
|-----|---------------------------------|--------------|--------|---------|----|
| 161 | Base de chapéu pequena britada | Ø39x8cm | 20Kg | Ø45mm* | 60 |
| 162 | Base de chapéu grande britada | Ø60x8cm | 45Kg | Ø60mm* | 20 |
| 353 | Base de chapéu gigante britada | Ø71x12cm | 94Kg | Ø70mm* | 6 |
| 357 | Base de chapéu oitavada britada | 51x10cm | 37Kg | Ø45mm* | 40 |
| 783 | Base quadra britada | 50x50x10cm | 55Kg | Ø60mm* | 20 |
| 784 | Base quadra britada c/ rodas | 50x50x17cm | 55,5Kg | Ø60mm* | 20 |
| 798 | Base quadra gigante britada | 75x75x11,5cm | 135Kg | Ø112mm* | 6 |

PINTADAS . PAINTED . PINTADOS . PAINTED

| | | | | | |
|-----|---------------------------------|-------------|--------|--------|----|
| 345 | Base de chapéu pequena pintada | Ø39x8cm | 20Kg | Ø45mm* | 60 |
| 346 | Base de chapéu oitavada pintada | 52x10cm | 37Kg | Ø45mm* | 40 |
| 347 | Base de chapéu grande pintada | Ø60x8cm | 45Kg | Ø60mm* | 20 |
| 785 | Base quadra pintada | 50x50x10cm | 55Kg | Ø60mm* | 20 |
| 786 | Base quadra pintada c/ rodas | 50x50x17cm | 55,5Kg | Ø60mm* | 20 |
| 991 | Base 4 peças (1) | 48x48x8,5cm | 40Kg | - | 40 |
| 992 | Base redonda de encaixe pintada | Ø54x8,5cm | 38Kg | 60mm* | 24 |

Todas as bases de chapéu contêm pés em resina e são embaladas individualmente em caixa de cartão, excepto Ref. 353 e 798.

* medidas exteriores

(1) Conjunto completo composto por 4 peças.



FONTES

FOUNTAINS
FUENTES
FONTAINES





ref. 425



ref. 428A



TAMBÉM DISPONÍVEL EM ENVELHECIDO OU AZUL ref. 428E / 428
ALSO AVAILABLE IN AGED OR BLUE
TAMBIÉN DISPONIBLE EN ENVEJECIDO O AZUL
AUSSI DISPONIBLE EN VIEILLI OU BLEU



TAMBÉM DISPONÍVEL EM BRITA ref. 424
ALSO AVAILABLE IN GRAVEL
TAMBIÉN DISPONIBLE EN GRAVA
AUSSI DISPONIBLE EN GRAVIER



ref. 420



TAMBÉM DISPONÍVEL EM AZUL ref. 421
ALSO AVAILABLE IN BLUE
TAMBIÉN DISPONIBLE EN AZUL
AUSSI DISPONIBLE EN BLEU

| | | | |
|-------|---|------------|-------|
| 420 | Fonte c/ pássaros, c/ lago e c/ vasos brita | Ø225x147cm | 695Kg |
| 421 | Fonte c/ pássaros, c/ lago e c/ vasos azul | Ø225x147cm | 695Kg |
| 425 | Fonte c/ pássaros pintada azul | Ø87x147cm | 135Kg |
| 424 | Fonte c/ pássaros em brita | Ø87x147cm | 135Kg |
| 428 A | Fonte c/ 2 pias amarela | Ø86x157cm | 142Kg |
| 428 E | Fonte c/ 2 pias envelhecido | Ø86x157cm | 142Kg |
| 428 | Fonte c/ 2 pias azul | Ø86x157cm | 142Kg |



ref. 116



TAMBÉM DISPONÍVEL EM BRITA
ALSO AVAILABLE IN GRAVEL
TAMBIÉN DISPONIBLE EN GRAVA
AUSSI DISPONIBLE EN GRAVIER



ref. 306



TAMBÉM DISPONÍVEL EM ENVELHECIDO
ALSO AVAILABLE IN AGED
TAMBIÉN DISPONIBLE EN ENVEJECIDO
AUSSI DISPONIBLE EN VIEILLI



ref. 503



ref. 503E



ref. 305



ref. 806



| | | | |
|-------|--|-------------|-------|
| 116 | Chafariz de parede c/ torneira envelhecido | 57x55x125cm | 85Kg |
| 306 | Chafariz de parede c/ torneira em brita | 57x55x125cm | 85Kg |
| 503 | Lavatório de parede 3 peças brita | 68x40x130cm | 62Kg |
| 503 E | Lavatório de parede 3 peças envelhecido | 68x40x130cm | 62Kg |
| 305 | Fonte c/ pássaros de parede brita | 57x51x110cm | 55Kg |
| 806 | Fonte borboleta | Ø84x145cm | 166Kg |

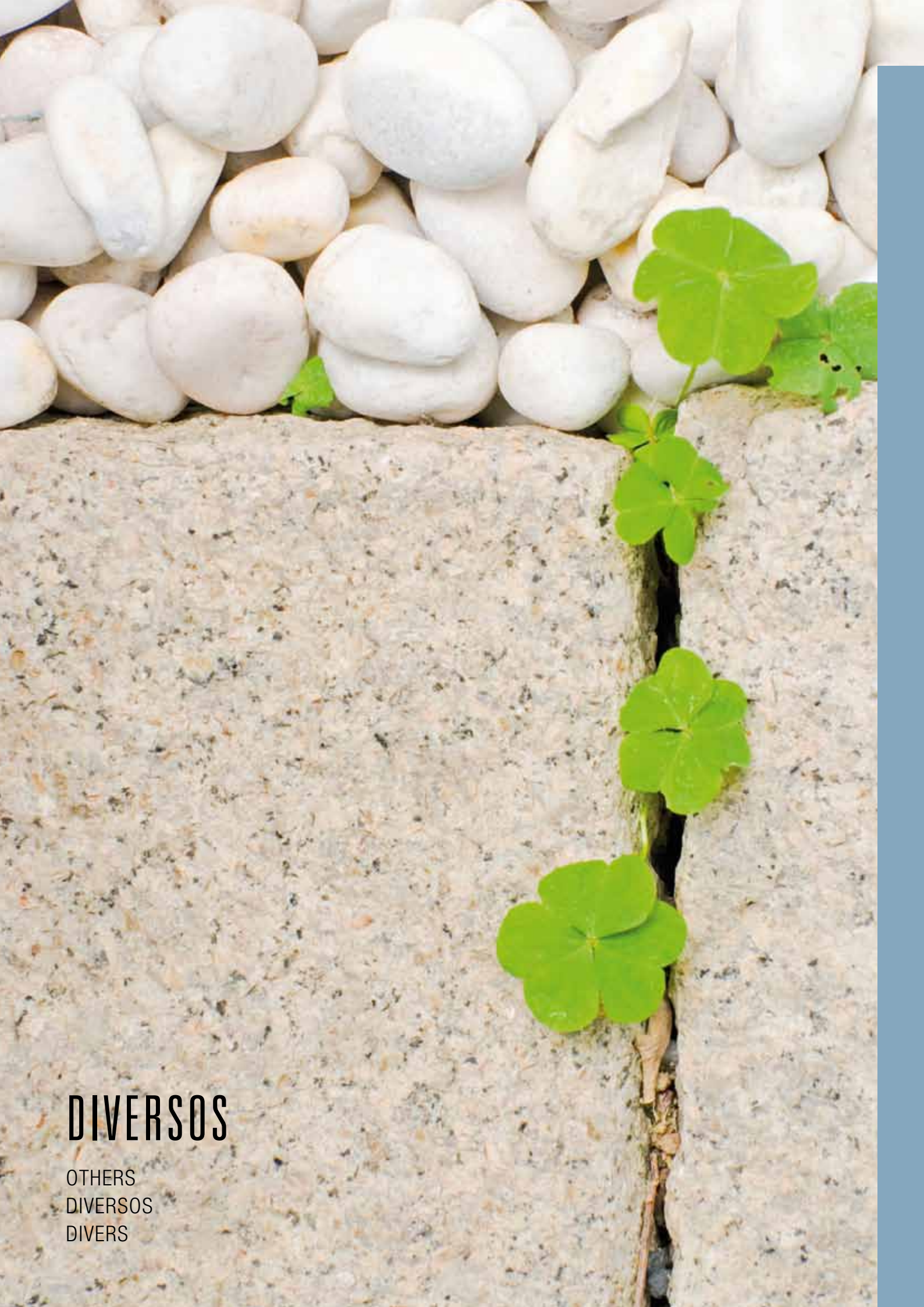

DIVERSOS

OTHERS
DIVERSOS
DIVERS

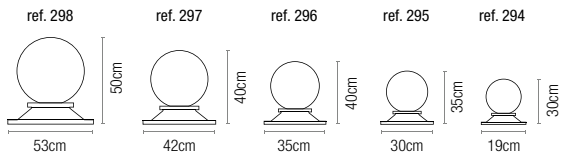
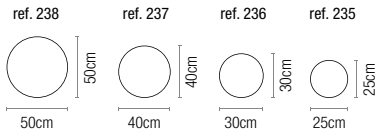

ref. 267



ref. 266



ref. 264



ref. 14



ref. 52



ref. 53

BOLAS . BALLS . BOLAS . BALLONS

| | | | |
|-----|-----------------------|-----------------|-------|
| 235 | Bola sem base pequena | Ø25cm | 12Kg |
| 236 | Bola sem base média | Ø30cm | 25Kg |
| 237 | Bola sem base grande | Ø40cm | 52Kg |
| 238 | Bola sem base gigante | Ø50cm | 94Kg |
| 294 | Bola com base mini | 19x19xØ20x30cm* | 12Kg |
| 295 | Bola com base pequena | 30x30xØ25x35cm* | 18Kg |
| 296 | Bola com base média | 35x35xØ30x40cm* | 32Kg |
| 297 | Bola com base grande | 42x42xØ40x40cm* | 61Kg |
| 298 | Bola com base gigante | 53x53xØ50x50cm* | 110Kg |
| 267 | Bola com 1 degrau | 15x15x20cm | 6Kg |
| 266 | Bola com 2 degraus | 19x19x23cm | 8Kg |
| 264 | Bola Gigante | 42x42x60cm | 94Kg |
| 14 | Bola pinha pequena | 14x24cm | 4Kg |
| 52 | Pinha | 18x38cm | 14Kg |
| 53 | Pinha Gigante | 23x23x56cm | 29Kg |

* base x diâmetro da bola x altura total





ref. 149

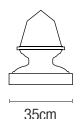

ref. 148



ref. 147



ref. 151

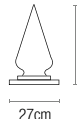

ref. 150

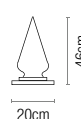

ref. 482



ref. 618

PIRÂMIDES . PYRAMIDS . PIRÁMIDES . PYRAMIDES

| | | | |
|-----|-----------------------|------------|------|
| 147 | Pirâmide pequena | 20x20x31cm | 9Kg |
| 148 | Pirâmide média | 25x25x36cm | 18Kg |
| 149 | Pirâmide grande | 35x35x51cm | 41Kg |
| 150 | Pirâmide bico pequena | 20x20x46cm | 11Kg |
| 151 | Pirâmide bico grande | 27x27x60cm | 25Kg |
| 482 | Pirâmide redonda | Ø24x42cm | 11Kg |
| 618 | Pirâmide anã | 25x25x25cm | 11Kg |

ACABAMENTOS . FINISHES . TERMINACIONES . FINITIONS

| | | | |
|-----|---------------------|------------|------|
| 481 | Acabamento de pilar | 42x42x50cm | 36Kg |
| 483 | Acabamento de pilar | 35x35x22cm | 15Kg |
| 140 | Acabamento de pilar | 34x34x10cm | 20Kg |
| 152 | Acabamento de pilar | 36x36x10cm | 23Kg |
| 144 | Acabamento de pilar | 50x50x10cm | 28Kg |
| 157 | Acabamento de pilar | 40x40x10cm | 25Kg |
| 706 | Acabamento de socle | 34x34x13cm | 15Kg |
| 707 | Acabamento de pilar | 34x34x13cm | 15Kg |
| 704 | Pilar grande | 27x27x63cm | 40Kg |
| 705 | Pilar pequeno | 27x27x55cm | 37Kg |
| 133 | Peça de pilar | 25x25x18cm | 9Kg |
| 134 | Peça de pilar | 40x40x18cm | 20Kg |
| 135 | Peça de pilar | 30x30x18cm | 12Kg |
| 136 | Peça de muro | 40x18x18cm | 9Kg |



ref. 481



ref. 483



ref. 140



ref. 152



ref. 144



ref. 707



ref. 157



ref. 706



ref. 704

ref. 705

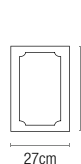
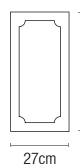

ref. 136



ref. 133

ref. 134

ref. 135

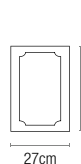
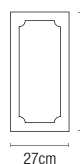



ref. 40



ref. 41



ref. 702



ref. 708



ref. 703



CORRIMÃOS

| | | | |
|-----|----------------------|-------------|------|
| 40 | Corrimão grande | 150x23x6cm | 40Kg |
| 41 | Corrimão com textura | 100x24x7cm | 28Kg |
| 702 | Corrimão | 100x23x8cm | 17Kg |
| 708 | Corrimão de encaixe | 100x18x6cm | 15Kg |
| 703 | Socle | 100x24x15cm | 57Kg |

BALAÚSTRES

| | | | |
|------|---------------------------|------------|--------|
| 668 | Balaústre lágrima pequeno | 11x11x60cm | 12Kg |
| 669 | Balaústre lágrima grande | 13x13x85cm | 18Kg |
| 669A | Balaústre lágrima escada | 13x13x95cm | 18,5Kg |
| 700 | Balaústre grande | 18x18x63cm | 18Kg |
| 701 | Balaústre pequeno | 16x16x55cm | 17Kg |

PILARES . PILLARS . PILARES . PILERS

| | | | |
|------|---|-------------------|-----------|
| 535 | Pilar liso simples | 15x15cm até 235cm | 57,5Kg/ml |
| 158 | Pilar de varanda oval Ø28cm | 32x32x222cm | 240Kg |
| 158A | Pilar de varanda oval Ø28cm | 32x32x236cm | 260Kg |
| 158B | Pilar de varanda oval Ø28cm | 32x32x250cm | 270Kg |
| 180 | Pilar de varanda oval Ø28cm | 32x32x130cm | 140Kg |
| 160 | Pilar de varanda redondo direito Ø22,5cm | 31x31x150a222cm | - |
| 160A | Pilar de varanda redondo direito Ø22,5cm | 31x31x223a250cm | - |
| 160B | Pilar de varanda redondo direito Ø22,5cm | 31x31x251a300cm | - |
| 181 | Pilar de varanda redondo direito Ø22,5cm | 31x31x130cm | - |
| 239 | Pilar de varanda quadrado simples Ø22,5cm | 32x32x155cm | 160Kg |
| 239A | Pilar de varanda quadrado simples Ø22,5cm | 32x32x250cm | 270Kg |



ref. 668

ref. 669

ref. 669A

ref. 700, 701

ref. 535



ref. 158, 158A, 158B, 180



ref. 160, 160A, 160B, 181



ref. 239, 239A



PILARES DISPONÍVEIS EM VÁRIOS TAMANHOS
PILLARS AVAILABLE IN SEVERAL SIZES
PILARES DISPONIBLES EN VARIOS TAMAÑOS
PILERS DISPONIBLES EN DIFFÉRENTES TAILLES

VIGAS E BARROTES

| | | | |
|-----|--|----------|------------|
| 508 | Barrote (disponível até 4m) | 10x6,5cm | 14,5Kg/ml |
| 509 | Barrote (disponível até 5,20m) | 15x9cm | 33,5Kg/ml |
| 510 | Barrote (disponível até 4,20m) | 12x7cm | 21,5Kg/ml |
| 511 | Viga (disponível até 4,20m) | 20x12cm | 59,50Kg/ml |
| 512 | Viga (disponível até 6m) | 23x14cm | 75Kg/ml |
| 530 | Barrote a imitar madeira* (disponível até 4m) | 10x6,5cm | 14Kg/ml |
| 531 | Barrote a imitar madeira* (disponível até 5,20m) | 15x9cm | 33Kg/ml |
| 532 | Barrote a imitar madeira* (disponível até 4,20m) | 20x12cm | 58Kg/ml |

* não inclui pintura.



ref. 532

ref. 531

ref. 530



ref. 509, 508, 510



ref. 508, 510, 511, 512



ref. 512



ref. 511

CHAMINÉS

| | | | |
|-----|--|-------------|-------|
| 433 | Chaminé grande c/grelha s/ aros e s/ tampa | 107x64x36cm | 184Kg |
| 434 | Chaminé média c/ grelha s/ aros e s/ tampa | 85x64x36cm | 157Kg |
| 435 | Chaminé pequena c/ grelha s/ aros e s/ tampa | 64x64x36cm | 129Kg |
| 484 | Chaminé Évora grande c/ 2 aros e c/ tampa | 110x68x72cm | 384Kg |
| 485 | Chaminé Évora média c/ 2 aros e c/ tampa | 89x68x72cm | 311Kg |
| 486 | Chaminé Évora pequena c/ 2 aros e c/ tampa | 69x69x72cm | 248Kg |
| 537 | Chaminé Évora pequena s/ aros e s/ tampa | 64x64x36cm | 129Kg |
| 538 | Chaminé Évora média s/ aros e s/ tampa | 85x64x36cm | 157Kg |
| 539 | Chaminé Évora grande s/ aros e s/ tampa | 107x64x36cm | 184Kg |
| 542 | Chaminé pequena c/ grelha c/ 2 aros e c/ tampa | 69x69x72cm | 248Kg |
| 544 | Chaminé grande c/ grelha c/ 2 aros e c/ tampa | 110x68x72cm | 384Kg |
| 549 | Chaminé média c/grelha c/ 2 aros e c/ tampa | 89x68x72cm | 311Kg |



ref. 544

ref. 549

ref. 542

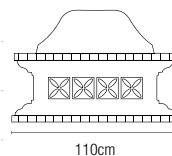

110cm

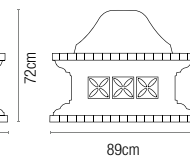

89cm

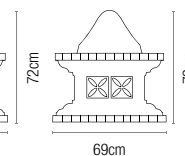

69cm



ref. 539

ref. 538

ref. 537

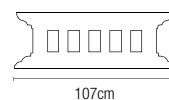

107cm

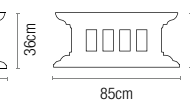

85cm

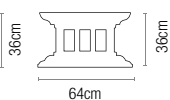

64cm



ref. 484

ref. 485

ref. 486

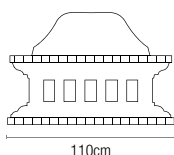

110cm

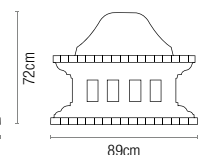

89cm

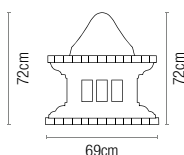

69cm



ref. 433

ref. 434

ref. 435

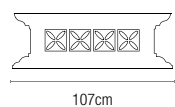

107cm

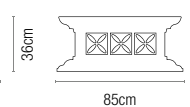

85cm

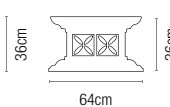

64cm



CASOTAS

| | | | medidas interior | medidas porta | |
|-----|-------------|-------------|------------------|---------------|-------|
| 950 | Casota nº 1 | 40x50x41cm | 26x35x28cm | 14x22cm | 35Kg |
| 951 | Casota nº 2 | 50x68x54cm | 35x45x38cm | 23x29cm | 65Kg |
| 952 | Casota nº 3 | 56x81x57cm | 38x55x40cm | 26x31cm | 70Kg |
| 953 | Casota nº 4 | 61x86x70cm | 51x60x50cm | 28x40cm | 135Kg |
| 954 | Casota nº 5 | 63x95x76cm | 51x73x55cm | 31x40cm | 180Kg |
| 955 | Casota nº 6 | 76x112x81cm | 60x78x57cm | 33x40cm | 220Kg |
| 956 | Casota nº 7 | 78x113x85cm | 68x93x70 | 37x48cm | 230Kg |
| 957 | Casota nº 8 | 85x117x93cm | 75x93x78 | 37x48 | 250Kg |

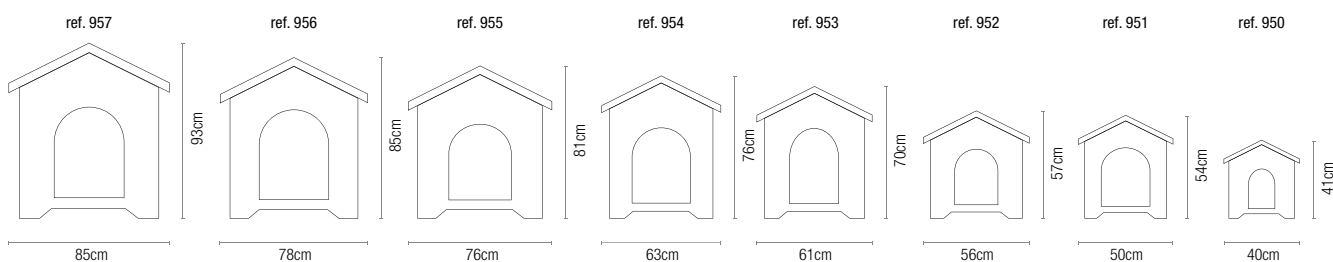

COMEDOUROS

| | | | |
|-----|--------------------------|-----------------|-----|
| 727 | Comedouro 1 pia pequeno | Ø19,5x6,5cm | 2Kg |
| 728 | Comedouro 1 pia médio | Ø25x7cm | 4Kg |
| 729 | Comedouro 1 pia grande | Ø28,5x8,5cm | 6Kg |
| 737 | Comedouro 2 pias pequeno | 29,5x15,5x5,5cm | 3Kg |
| 738 | Comedouro 2 pias médio | 36x20x6cm | 5Kg |
| 739 | Comedouro 2 pias grande | 44,5x24x7,5cm | 9Kg |

ref. 727, 728, 729



ref. 737, 738, 739



BETÃO NATURAL OU PINTADO . NATURAL CONCRETE OR PAINTED
 HORMIGÓN NATURAL O PINTADO . BÉTON NATUREL OU PEINT
 DISPONÍVEIS EM VÁRIOS TAMAÑOS . AVAILABLE IN SEVERAL SIZES
 DISPONIBLES EN VARIOS TAMAÑOS . DISPONIBLES EN DIFFÉRENTES TAILLES

CAIXAS CORREIO / CANDEEIROS

| | | | |
|-----|----------------------------------|-------------|-------|
| 269 | Caixa do correio grande | 43x34x43cm | 32Kg |
| 270 | Caixa do correio pequena redonda | 34x28x34cm | 17Kg |
| 271 | Caixa do correio pequena | 34x25x39cm | 17Kg |
| 621 | Pé de correio pequeno | 36x26x75cm | 70Kg |
| 622 | Pé de correio grande | 40x30x77cm | 85Kg |
| 629 | Conjunto grande c/269 + 622 | 43x34x120cm | 117Kg |
| 630 | Conjunto pequeno c/270 + 621 | 34x25x114cm | 87Kg |
| 720 | Candeiro pequeno | 40x36cm | 20Kg |
| 721 | Candeiro grande | 50x47cm | 38Kg |
| 722 | Pé de candeiro | 42x33x85cm | 77Kg |
| 723 | Conjunto pé + candeiro pequeno | 42x33x121cm | 97Kg |
| 724 | Conjunto pé + candeiro grande | 42x33x132cm | 115Kg |
| 725 | Vidro candeiro pequeno | Ø12x18cm | - |
| 726 | Vidro candeiro grande | Ø17x20cm | - |



TAMBÉM DISPONÍVEL EM PEÇAS INDIVIDUAIS
ALSO AVAILABLE IN INDIVIDUAL PIECES
TAMBIÉN DISPONIBLE EN PIEZAS INDIVIDUALES
AUSSI DISPONIBLE EN PIÈCES INDIVIDUELS



ref. 629



ref. 630



ref. 724



ref. 723



ref. 271



ref. 725



ref. 726



PINTADO OURO, PINTADO PRATA, PINTADO VERDE, NATURAL ENVELHECIDO OU NATURAL BRANCO
 GOLD PAINTED, SILVER PAINTED, GREEN PAINTED, AGED NATURAL OR WHITE NATURAL
 PINTADO ORO, PINTADO PLATA, PINTADO VERDE, NATURAL ENVEJECIDO O NATURAL BLANCO
 PEINT OR, PEINT ARGENT, PEINT VERT, NATUREL VIEILLI OU NATUREL BLANC



ref. G384



ref. G554



ref. G562



ref. G540



ref. G548





ref. G772



ref. G771



ref. G802A



ref. G790



ref. G764



ref. G763



ref. G1182



ref. G1184

| | | | |
|------|-----------|-------------|-------|
| G384 | Guerreira | 45x40x145cm | 190Kg |
|------|-----------|-------------|-------|

| | | | |
|------|------------------|-------------|-------|
| G554 | Venus sem braços | 33x33x130cm | 120Kg |
|------|------------------|-------------|-------|

| | | | |
|------|-------------|---------|------|
| G540 | Buda grande | 62x80cm | 65Kg |
|------|-------------|---------|------|

| | | | |
|------|--------------|------------|------|
| G562 | Buda pequeno | 28x22x45cm | 19Kg |
|------|--------------|------------|------|

| | | | |
|------|-------------|------------|------|
| G548 | Buda mulher | 32x32x60cm | 77Kg |
|------|-------------|------------|------|

| | | | |
|------|----------------------------|----------|------|
| G763 | Águia asas abertas pequena | Ø15x37cm | 20Kg |
|------|----------------------------|----------|------|

| | | | |
|------|---------------------------|------------|------|
| G764 | Águia asas abertas grande | 20x59x60cm | 63Kg |
|------|---------------------------|------------|------|

| | | | |
|------|---------------|-----------|-------|
| G772 | Águia gigante | Ø55x105cm | 200Kg |
|------|---------------|-----------|-------|

| | | | |
|------|-----------------------|-----------|-------|
| G771 | Águia gigante c/ base | Ø55x140cm | 250Kg |
|------|-----------------------|-----------|-------|

| | | | |
|------|----------------|------------|------|
| G790 | Cavalo pequeno | 26x26x80cm | 46Kg |
|------|----------------|------------|------|

| | | | |
|-------|---------------|-------------|-------|
| G802A | Cavalo grande | 33x60x130cm | 140Kg |
|-------|---------------|-------------|-------|

| | | | |
|-------|---------------|------------|------|
| G1182 | Cisne pequeno | 20x38x40cm | 13Kg |
|-------|---------------|------------|------|

| | | | |
|-------|--------------|------------|------|
| G1184 | Cisne grande | 38x70x60cm | 60Kg |
|-------|--------------|------------|------|

| | | | |
|-------|----------------|----------|-------|
| G1125 | Vaso primavera | Ø65x77cm | 110Kg |
|-------|----------------|----------|-------|

| | | | |
|-------|---------------|----------|------|
| G1178 | Cesto c/laços | Ø40x80cm | 58Kg |
|-------|---------------|----------|------|

| | | | |
|-----|----------------|------------|-------|
| 520 | Tartaruga mini | 10x6,5x4cm | 0,1Kg |
|-----|----------------|------------|-------|

| | | | |
|-----|-------------------|-----------|-------|
| 521 | Tartaruga pequena | 18x11x7cm | 1,5Kg |
|-----|-------------------|-----------|-------|

| | | | |
|-----|-----------------|------------|-----|
| 522 | Tartaruga média | 30x22x13cm | 9Kg |
|-----|-----------------|------------|-----|

| | | | |
|-----|------------------|------------|------|
| 523 | Tartaruga grande | 67x48x31cm | 24Kg |
|-----|------------------|------------|------|



ref. 520



ref. 521



ref. 522



ref. 523



ref. G1125



ref. G1178



geral@artimentos.pt
www.artimentos.pt

T +351 244 766 271/2
F +351 244 766 273

Z. Ind. da Jardoeira, lt. 18 e 27
2440-474 Batalha . Portugal