

ELECTRICIDAD

Pequeño material eléctrico
Luces Emergencia
Mata Mosquitos
Prolongaciones
Enrollacables
Linternas
Canaleta
Cetacs
Cable
Pilas

SANEAMIENTO

Accesorios Calefacción
Conexiones y latiguillos
Accesorios Manguera
Accesorios de Cobre
Accesorios de Latón
Accesorios Lavabo
Evacuación PVC
Pegamentos
Desagües
Grifería
Fitting
Llaves
Ducha



Apliques
Regletas
Downlights
Sobremesa
Bombillería
Proyectores
Fluorescencia
Aros de empotrar
Iluminación Exterior

ILUMINACION

Buzones
Candados
Extracción
Ventilación
Guirnaldas
Cerraduras
Herramientas
Menaje cocina
Herramientas Jardín
Herramientas para obra
Electrónica de consumo
Pequeño electrodoméstico

FERRETERIA

DELEGACION BARCELONA

C/Doctor Trueta, 188 - 08005 Barcelona
tlf. 34 93.2251428 - fax 34 93.2251368

DELEGACION MASQUEFA

C/Sant Llorenç d Hortons,8
Pol.Ind.La Pedrosa - 08783 Barcelona
tlf. 34 93.7726767 - fax 34 93.7726504

DELEGACION CHINA

Room 1003, Junsheng technology Square, 1071
Guangxian road, Jiangdong district, Ningbo, China
tel./fax. 0086.574.87.353.142



ILUMINACION

BOMBILLERIA

| | |
|----------------------------|------------|
| INCANDESCENCIA..... | 1-3 |
| HALOGENA..... | 3-5 |
| HALOGENUROS..... | 5 |
| BAJO CONSUMO..... | 6-9 |
| FLUORESCENCIA..... | 9 |

ILUMINACION INTERIOR

| | |
|--|--------------|
| EMPOTRABLES HALOGENOS, TRANSFORMADORES..... | 10-11 |
| EMPOTRABLES POLVERAS, GX53, LEDS..... | 12 |
| EMPOTRABLES/DOWNLIGHTS..... | 13-14 |
| FOCOS HALOGENUROS..... | 15 |
| REGLETAS FLUORESCENCIA..... | 16-17 |
| REGLETAS/APLIQUES REFLECTORAS..... | 18 |
| SOBRE-MESA, APLIQUES..... | 19-24 |
| PIES DE SALON..... | 25 |

ILUMINACION EXTERIOR

| | |
|---|--------------|
| PROYECTORES HALOGENOS..... | 26-27 |
| PROYECTORES BAJO CONSUMO Y LEDS..... | 27-28 |
| PROYECTORES HALOGENUROS..... | 28 |
| FAROLAS..... | 29 |
| EMPOTRABLES..... | 30 |
| TORTUGAS..... | 31 |
| APLIQUES EXTERIOR..... | 31-34 |
| PINCHO SOLAR/EMPOTRABLE LED, VARIOS..... | 35 |



Ver página 35

INCANDESCENCIA



USO INDUSTRIAL



STANDAR

| REFERENCIA | VOLTAJE | WATIOS | COLOR | CASQUILLO |
|-------------------|---------|--------|-------|-----------|
| BST.23040 | 250V | 40W | CLARA | E-27 |
| BST.23060 | 250V | 60W | CLARA | E-27 |
| BST.230100 | 250V | 100W | CLARA | E-27 |
| BST.230150 | 250V | 150W | CLARA | E-27 |
| BST.230200 | 250V | 200W | CLARA | E-27 |
| BST.13060 | 125V | 60W | CLARA | E-27 |
| BST.130100 | 125V | 100W | CLARA | E-27 |



STANDAR COLORES

| REFERENCIA | VOLTAJE | WATIOS | COLOR | CASQUILLO |
|--------------------|---------|--------|-------|-----------|
| BST.23025.R | 250V | 25W | ROJA | E-27 |



STANDAR INSECTOS

| REFERENCIA | VOLTAJE | WATIOS | COLOR | CASQUILLO |
|--------------------|---------|--------|----------|-----------|
| BST.23060.I | 250V | 60W | AMARILLA | E-27 |



ESFERICAS

| REFERENCIA | VOLTAJE | WATIOS | COLOR | CASQUILLO |
|--------------------|---------|--------|-------|-----------|
| BES.23025 | 250V | 25W | CLARA | E-27 |
| BES.23040 | 250V | 40W | CLARA | E-27 |
| BES.23060 | 250V | 60W | CLARA | E-27 |
| BES.23025M | 250V | 25W | CLARA | E-14 |
| BES.23040M | 250V | 40W | CLARA | E-14 |
| BES.23060M | 250V | 60W | CLARA | E-14 |
| BES.23025NM | 250V | 25W | MATE | E-27 |
| BES.23040NM | 250V | 40W | MATE | E-27 |
| BES.23060NM | 250V | 60W | MATE | E-27 |
| BES.23025MM | 250V | 25W | MATE | E-14 |
| BES.23040MM | 250V | 40W | MATE | E-14 |
| BES.23060MM | 250V | 60W | MATE | E-14 |
| BES.13025 | 125V | 25W | CLARA | E-27 |





VELAS

| REFERENCIA | VOLTAJE | WATIOS | COLOR | CASQUILLO |
|------------------|---------|--------|-------|-----------|
| BV.23025 | 250V | 25W | CLARA | E-14 |
| BV.23040 | 250V | 40W | CLARA | E-14 |
| BV.23060 | 250V | 60W | CLARA | E-14 |
| BV.23025M | 250V | 25W | MATE | E-14 |
| BV.23040M | 250V | 40W | MATE | E-14 |
| BV.23060M | 250V | 60W | MATE | E-14 |

VELAS RIZADAS

| REFERENCIA | VOLTAJE | WATIOS | COLOR | CASQUILLO |
|-------------------|---------|--------|-------|-----------|
| BV.23040RM | 250V | 40W | MATE | E-14 |
| BV.23060RM | 250V | 60W | MATE | E-14 |



SOFTONE STANDAR

| REFERENCIA | VOLTAJE | WATIOS | COLOR | CASQUILLO |
|------------------|---------|--------|-------|-----------|
| BS.23060 | 250V | 60W | OPAL | E-27 |
| BS.230100 | 250V | 100W | OPAL | E-27 |

SOFTONE MINI

| REFERENCIA | VOLTAJE | WATIOS | COLOR | CASQUILLO |
|-------------------|---------|--------|-------|-----------|
| BS.23040MN | 250V | 40W | OPAL | E-27 |
| BS.23060MN | 250V | 60W | OPAL | E-27 |
| BS.23040MM | 250V | 40W | OPAL | E-14 |
| BS.23060MM | 250V | 60W | OPAL | E-14 |



GLOBOS Ø125mm

| REFERENCIA | VOLTAJE | WATIOS | COLOR | CASQUILLO |
|------------------|---------|--------|-------|-----------|
| G.12560V | 250V | 60W | OPAL | E-27 |
| G.125100V | 250V | 100W | OPAL | E-27 |



TUBULAR NEVERA

| REFERENCIA | VOLTAJE | WATIOS | MEDIDA | CASQUILLO |
|------------------|---------|--------|---------|-----------|
| BTU.22015 | 250V | 15W | 25x55mm | E-14 |
| BTU.22025 | 250V | 25W | 25x55mm | E-14 |

PAR-38 CRISTAL

| REFERENCIA | VOLTAJE | WATIOS | Ø | Long. | CASQUILLO |
|------------------|---------|--------|-------|-------|-----------|
| BPAR.3880 | 250V | 80W | 121mm | 135mm | E27 |



REFLECTORAS

| REFERENCIA | VOLTAJE | WATIOS | Ø | LONG. | CASQUILLO |
|------------|---------|--------|------|-------|-----------|
| BR.3930V | 230V | 30W | 39mm | 67mm | E-14 |
| BR.5040V | 230V | 40W | 50mm | 86mm | E-14 |
| BR.5060V | 230V | 60W | 50mm | 86mm | E-14 |
| BR.6340V | 230V | 40W | 63mm | 102mm | E-27 |
| BR.6360V | 230V | 60W | 63mm | 102mm | E-27 |
| BR.8040V | 230V | 40W | 80mm | 116mm | E-27 |
| BR.8060V | 230V | 60W | 80mm | 116mm | E-27 |
| BR.80100V | 230V | 100W | 80mm | 116mm | E-27 |
| BR.9060V | 230V | 60W | 90mm | 116mm | E-27 |
| BR.90100V | 230V | 100W | 90mm | 116mm | E-27 |



HALOGENAS

DICROICAS

| REFERENCIA | VOLTAJE | WATIOS | Ø | °C | LONGITUD | CASQUILLO |
|------------|---------|--------|------|----|----------|-----------|
| BH.EXNT | 12V | 50W | 50mm | 38 | 45mm | G5,3 |
| BH.FNVT | 12V | 50W | 50mm | 60 | 45mm | G5,3 |
| BH.EXN.20P | 12V | 20W | 35mm | 30 | 35mm | G4 |
| BH.EXN.35P | 12V | 35W | 35mm | 30 | 35mm | G4 |

descatalogado

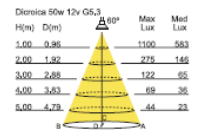

DICROICAS GU10

| REFERENCIA | VOLTAJE | WATIOS | Ø | °C | LONGITUD | CASQUILLO |
|------------|---------|--------|------|----|----------|-----------|
| BH.GU10 | 230V | 50W | 50mm | 38 | 55mm | GU10 |
| BH.GU10.75 | 230V | 75W | 50mm | 38 | 55mm | GU10 |

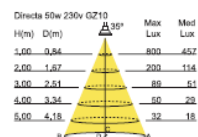

LINEAL

| REFERENCIA | VOLTAJE | WATIOS | LONGITUD | CASQUILLO |
|------------|---------|--------|----------|-----------|
| BH.100.7,8 | 230V | 100W | 78mm | R7s |
| BH.150.7,8 | 230V | 150W | 78mm | R7s |
| BH.250.7,8 | 230V | 250W | 78mm | R7s |
| BH.100 | 230V | 100W | 118mm | R7s |
| BH.150 | 230V | 150W | 118mm | R7s |
| BH.200 | 230V | 200W | 118mm | R7s |
| BH.300 | 230V | 300W | 118mm | R7s |
| BH.500 | 230V | 500W | 118mm | R7s |
| BH.1000 | 230V | 1000W | 189mm | R7s |



LINEAL AHORRO

| REFERENCIA | VOLTAJE | WATIOS | LONGITUD | CASQUILLO |
|-------------|---------|-----------|----------|-----------|
| BHA.105.7,8 | 230V | 105W=150W | 78mm | R7s |
| BHA.200 | 230V | 200W=300W | 118mm | R7s |
| BHA.350 | 230V | 350W=500W | 118mm | R7s |



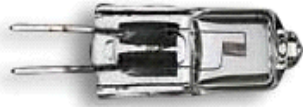

BI-PIN

REFERENCIA VOLTAJE WATIOS Ø LONGITUD CASQUILLO

| | | | | | |
|------------------|------|------|------|------|----------------------------|
| BH.12.20 | 12V | 20W | 9mm | 30mm | G4 |
| BH.12.50 | 12V | 50W | 12mm | 44mm | G6,35 |
| BH.12.100 | 12V | 100W | 12mm | 44mm | G6,35 |
| BH.220.50 | 230V | 50W | 14mm | 57mm | G6,35 <i>descatalogado</i> |



BI-PIN G9

REFERENCIA VOLTAJE WATIOS Ø LONGITUD CASQUILLO

| | | | | | |
|---------------------|------|-----|------|------|----|
| BH.G9.40 | 230V | 40W | 14mm | 57mm | G9 |
| BH.G9.40Mate | 230V | 40W | 14mm | 57mm | G9 |
| BH.G9.60 | 230V | 60W | 14mm | 57mm | G9 |
| BH.G9.60Mate | 230V | 60W | 14mm | 57mm | G9 |

ECOClassic30. HALOGENAS CON ROSCA

28w

40w

53w

75w

42w

60w

70w

100w

105w

150w

-30% de ahorro
100% Regulables

REFERENCIA VOLTAJE WATIOS CASQUILLO LUMENS DURACION

esféricas

| | | | | | |
|----------------------|------|-----|------|-----|----------------------------------|
| BH.ES28M | 230V | 28W | E-14 | 350 | 2.000 horas |
| BH.ES28 | 230V | 28W | E-27 | 350 | 2.000 horas |
| BH.ES42M | 230V | 42W | E-14 | 630 | 2.000 horas |
| BH.ES42 | 230V | 42W | E-27 | 630 | 2.000 horas |
| BH.ES42.MMate | 230V | 42W | E-14 | 630 | 2.000 horas <i>descatalogado</i> |
| BH.ES42.NMate | 230V | 42W | E-27 | 630 | 2.000 horas <i>descatalogado</i> |

velas

| | | | | | |
|--------------------|------|-----|------|-----|----------------------------------|
| BH.V28 | 230V | 28W | E-14 | 350 | 2.000 horas |
| BH.V42 | 230V | 42W | E-14 | 630 | 2.000 horas |
| BH.V42.Mate | 230V | 42W | E-14 | 630 | 2.000 horas <i>descatalogado</i> |

standars

| | | | | | |
|---------------------|------|------|------|------|----------------------------------|
| BH.ST28 | 230V | 28W | E-27 | 350 | 2.000 horas |
| BH.ST42 | 230V | 42W | E-27 | 630 | 2.000 horas |
| BH.ST42.Mate | 230V | 42W | E-27 | 630 | 2.000 horas <i>descatalogado</i> |
| BH.ST53 | 230V | 53W | E-27 | 850 | 2.000 horas |
| BH.ST70 | 230V | 70W | E-27 | 1200 | 2.000 horas |
| BH.ST105 | 230V | 105W | E-27 | 2100 | 2.000 horas |

reflectoras

| | | | | | |
|-----------------|------|-----|------|------|-------------|
| BH.R5042 | 230V | 42W | E-14 | 630 | 2.000 horas |
| BH.R6342 | 230V | 42W | E-27 | 630 | 2.000 horas |
| BH.R6353 | 230V | 53W | E-27 | 850 | 2.000 horas |
| BH.R8070 | 230V | 70W | E-27 | 1200 | 2.000 horas |

PAR-30 HALOGENA

REFERENCIA VOLTAJE WATIOS Ø LONGITUD CASQUILLO

| | | | | | |
|----------------|------|------|------|--------|------|
| BPAR.30 | 230V | 100W | 97mm | 90,5mm | E-27 |
|----------------|------|------|------|--------|------|

QR-111

| REFERENCIA | VOLTAJE | WATIOS | Ø | °C | COLOR | CASQ |
|------------|---------|--------|-------|----|--------|------|
| BQR111.50 | 12V | 50W | 111mm | 24 | 2800°K | G53 |
| BQR111.100 | 12V | 100W | 111mm | 24 | 2800°K | G53 |

QR-111 GU10

| REFERENCIA | VOLTAJE | WATIOS | Ø | °C | COLOR | CASQ |
|------------|---------|--------|-------|----|--------|------|
| BQR111G100 | 220V | 100W | 111mm | 24 | 2800°K | GU10 |



HALOGENUROS

HALOGENURO METÁLICO

| REFERENCIA | WATIOS | COLOR | LONGITUD | CASQUILLO |
|------------|--------|---------------|----------|-----------|
| BHQI.70 | 70W | FRIO=4000°K | 118mm | RX7s |
| BHQI.70C | 70W | CALIDO=2700°K | 118mm | RX7s |
| BHQI.150 | 150W | FRIO=4000°K | 135mm | RX7s |
| BHQI.150C | 150W | CALIDO=2700°K | 135mm | RX7s |



Sustitutas Halógena Lineal

Bajo Consumo

Duración: 8.000 horas

Sustituta Halógena Lineal 78mm. Para focos R7s 150w
220V-240V - 50Hz - 12W - 720Lm

BPL.EX12/3 - 3000°K

BPL.EX12/6 - 6500°K

Sustituta Halógena Lineal 118mm. Para focos R7s 500w
220V-240V - 50Hz - 20W - 1200Lm

BPL.EX20/3 - 3000°K

BPL.EX20/6 - 6500°K

Sustituta Halógena Lineal 189mm. Para focos R7s 1000w
220V-240V - 50Hz - 20W - 2400Lm

BPL.EX40/3 - 3000°K

BPL.EX40/6 - 6500°K



LEDS

Duración: 20.000 horas

Sustituta Halógena Lineal 118mm.
Para focos R7s 500w

220V-240V - 50Hz - 6W - 360Lm - 92 Leds

BLED.EX6 - 4000°K

Duración: 50.000 horas

Sustituta Halógena Lineal 118mm.
Para focos R7s 500w

220V-240V - 50Hz - 8W - 720Lm - 36 Leds

BLED.EX8/4 - 4000°K

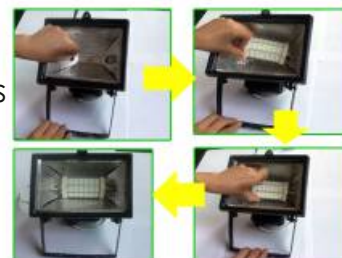

BLED.EX8/6 - 6000°K

iluminación

bombillas

BAJO CONSUMO



2 TUBOS

| REFERENCIA | POTENCIA | NºTUBOS | ROSCA |
|------------|----------|---------|-------|
| BPL.5 | 5W | 2 | E-27 |
| BPL.5M | 5W | 2 | E-14 |
| BPL.9 | 9W | 2 | E-27 |
| BPL.11 | 11W | 2 | E-27 |
| BPL.11M | 11W | 2 | E-14 |



3 TUBOS

| REFERENCIA | POTENCIA | NºTUBOS | ROSCA |
|------------|----------|---------|-------|
| BPL.15 | 15W | 3 | E-27 |
| BPL.15M | 15W | 3 | E-14 |
| BPL.20 | 20W | 3 | E-27 |
| BPL.25 | 25W | 3 | E-27 |



4 TUBOS

| REFERENCIA | POTENCIA | NºTUBOS | ROSCA |
|------------|----------|---------|-------|
| BPL.36 | 36W | 4 | E-27 |



CON SENSOR CREPUSCULAR

| REFERENCIA | POTENCIA | NºTUBOS | ROSCA |
|------------|----------|---------|-------|
| BPL.20S | 20W | 3 | E-27 |
| BPL.20RS | 20W | RIZADA | E-27 |

MINIS

| REFERENCIA | POTENCIA | NºTUBOS | ROSCA |
|------------|----------|---------|-------|
| BPL.8 | 8W | 3 | E-27 |
| BPL.23 | 23W | 6 | E-27 |
| BPL.27 | 27W | 4 | E-27 |

RIZADAS

| REFERENCIA | POTENCIA | NºTUBOS | ROSCA |
|------------|----------|---------|-------|
| BPL.5R | 5W | RIZADA | E-27 |
| BPL.5MR | 5W | RIZADA | E-14 |
| BPL.9R | 9W | RIZADA | E-27 |
| BPL.9MR | 9W | RIZADA | E-14 |
| BPL.11R | 11W | RIZADA | E-27 |
| BPL.11MR | 11W | RIZADA | E-14 |
| BPL.15R | 15W | RIZADA | E-27 |
| BPL.15MR | 15W | RIZADA | E-14 |
| BPL.20R | 20W | RIZADA | E-27 |
| BPL.25R | 25W | RIZADA | E-27 |
| BPL.36R | 36W | RIZADA | E-27 |

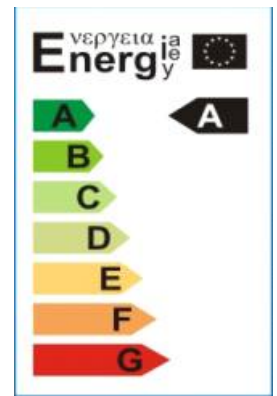
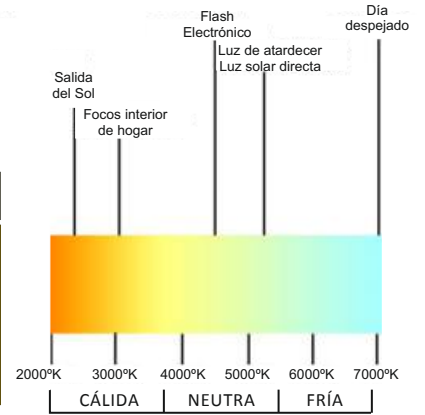



EXTRA-GRANDE

| REFERENCIA | VOLTAJE | WATIOS | LUMENS | COLOR | LONG. | ROSCA |
|------------------|---------|--------|--------|--------|-------|-------|
| BPL.120/6 | 230V | 120W | 4650 | 6500°K | 282mm | E-27 |
| BPL.200/6 | 230V | 200W | 9300 | 6500°K | 397mm | E-40 |

GU-10

| REFERENCIA | VOLTAJE | WATIOS | LUMENS | COLOR | LONG. | ROSCA |
|-------------------|---------|--------|--------|--------|-------|-------|
| BPL.GU10/9 | 230V | 9W | 480 | 3000°K | 95mm | GU-10 |



GU-10

| REFERENCIA | VOLTAJE | WATIOS | LUMENS | COLOR | Ø | ROSCA |
|-----------------|---------|--------|--------|--------|------|-------|
| BPL.GU11 | 230V | 11W | 380 | 3000°K | 50mm | GU-10 |



GU-10

| REFERENCIA | VOLTAJE | WATIOS | LUMENS | COLOR | Ø | ROSCA |
|-------------------|---------|--------|--------|--------|------|-------|
| BPL.MR16/9 | 230V | 9W | 320 | 3000°K | 50mm | G5,3 |



MR-16

| REFERENCIA | VOLTAJE | WATIOS | LUMENS | COLOR | Ø | ROSCA |
|-------------------------------------|---------|--------|--------|--------|------|-------|
| BPL.MR16 | 230V | 3W | 150 | 4200°K | 50mm | G5,3 |
| <i>NECESITA EQUIPO TR163</i> | | | | | | |



G9

| REFERENCIA | VOLTAJE | WATIOS | LUMENS | COLOR | LONG. | ROSCA |
|-----------------|---------|--------|--------|--------|-------|-------|
| BPL.G9/7 | 230V | 7W | 380 | 3000°K | 83mm | G9 |



GX53

| REFERENCIA | VOLTAJE | WATIOS | LUMENS | COLOR | Ø | ROSCA |
|--|---------|--------|--------|--------|------|-------|
| BGX53.PL7 | 230V | 7W | 220 | 4200°K | 74mm | GX53 |
| BGX53.PL9 | 230V | 9W | 260 | 4200°K | 74mm | GX53 |
| <i>FOCOS SUPERFICIE Y EMPOTRAR PARA GX53 EN PÁGINA 19 DE ILUMINACIÓN</i> | | | | | | |





STANDAR A60

| REFERENCIA | HORAS | POTENCIA | LUMENS | COLOR | LONG. | ROSCA |
|------------|-------|----------|--------|--------|--------|-------|
| BPL.ST11 | 8.000 | 11W | 535 | 2700°K | 60x120 | E-27 |



MINI GLOBO G60

| REFERENCIA | HORAS | POTENCIA | LUMENS | COLOR | LONG. | ROSCA |
|------------|-------|----------|--------|--------|--------|-------|
| BPL.G9 | 8.000 | 9W | 415 | 2700°K | 64x110 | E-27 |
| BPL.G9M | 8.000 | 9W | 415 | 2700°K | 64x110 | E-14 |



ESFERICA G50

| REFERENCIA | HORAS | POTENCIA | LUMENS | COLOR | LONG. | ROSCA |
|------------|-------|----------|--------|--------|-------|-------|
| BPL.ES9 | 8.000 | 9W | 415 | 2700°K | 50x90 | E-27 |
| BPL.ES9M | 8.000 | 9W | 415 | 2700°K | 50x90 | E-14 |



VELA C45

| REFERENCIA | HORAS | POTENCIA | LUMENS | COLOR | LONG. | ROSCA |
|------------|-------|----------|--------|--------|--------|-------|
| BPL.V9 | 8.000 | 9W | 415 | 2700°K | 40x130 | E-14 |



REFLEKTORA R-63

| REFERENCIA | HORAS | POTENCIA | LUMENS | COLOR | LONG. | ROSCA |
|------------|-------|----------|--------|--------|--------|-------|
| BPL.R63/13 | 8.000 | 13W | 350 | 4200°K | 63x105 | E-27 |



REFLEKTORA R-80

| REFERENCIA | HORAS | POTENCIA | LUMENS | COLOR | LONG. | ROSCA |
|------------|-------|----------|--------|--------|--------|-------|
| BPL.R80/15 | 8.000 | 15W | 450 | 3000°K | 80x110 | E-27 |



GLOBO 110mm

| REFERENCIA | HORAS | POTENCIA | LUMENS | COLOR | LONG. | ROSCA |
|------------|-------|----------|--------|--------|---------|-------|
| BPL.G23 | 8.000 | 23W | 1100 | 3000°K | 165x110 | E-27 |

PAR-38 23W

REFERENCIA HORAS POTENCIA LUMENS COLOR LONG. ROSCA

BPL.PAR38/25 8.000 23W 645 4200°K 120mm E-27



BAJO CONSUMO CON PATAS

REFERENCIA HORAS POTENCIA COLOR LONG. ROSCA

BPLS.9/4 8.000 9W 4200°K 151mm 2G7

BPLS.11/4 8.000 11W 4200°K 220mm 2G7

BPLC.7/4 8.000 7W 4200°K 137mm G23

BPLC.9/4 8.000 9W 4200°K 167mm G23

BPLC.11/4 8.000 11W 4200°K 237mm G23

BPLC.13/4 8.000 13W 4200°K 140mm G24d1

BPLC.26/4 8.000 26W 4200°K 173mm G24d3

4 patas



2 patas



2 patas



FLUORESCENCIA

REFERENCIA COLOR POTENCIA LONG. CASQUILLO

TF.4 6500°K 4W 136mm G5

TF.6 6500°K 6W 212mm G5

TF.8 6500°K 8W 288mm G5

TF.13 6500°K 13W 517mm G5

TF.15D 6500°K 15W 438mm G13

TF.18DV 6500°K 18W 600mm G13

TF.36DV 6500°K 36W 1200mm G13

TF.58DV 6500°K 58W 1500mm G13

TF.1884V 4000°K 18W 600mm G13

TF.3684V 4000°K 36W 1200mm G13

TF.5884V 4000°K 58W 1500mm G13

TF.1886V 6500°K 18W 600mm G13

TF.3686V 6500°K 36W 1200mm G13

TF.5886V 6500°K 58W 1500mm G13



REFERENCIA COLOR POTENCIA LONG. CASQUILLO

TF.4BLB LUZ NEGRA 4W 136mm G5

TF.6BLB LUZ NEGRA 6W 212mm G5

TF.8BLB LUZ NEGRA 8W 288mm G5



REFERENCIA COLOR POTENCIA LONG. CASQUILLO

TF.6BL ACTINICO 6W 212mm G5

TF.8BL ACTINICO 8W 288mm G5

TF.15BL ACTINICO 15W 438mm G13



REFERENCIA COLOR POTENCIA LONG. CASQUILLO

TC.22DV 6500°K 22W 148mm G10q

TC.32DV 6500°K 32W 237mm G10q

TC.40DV 6500°K 40W 338mm G10q



REFERENCIA POTENCIA TIPO

mevi.1422 4-22W CEBADOR FS-2

mevi.1480 4-80W CEBADOR FS-U



AROS DE EMPOTRAR



| CHAPA FIJO | |
|-------------------|------------|
| REFERENCIA | COLOR |
| FOFI.B | BLANCO |
| FOFI.CM | CROMO MATE |
| FOFI.O | ORO |

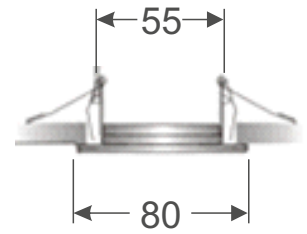

| CHAPA GIRATORIO | |
|------------------------|------------|
| REFERENCIA | COLOR |
| FOGI.B | BLANCO |
| FOGI.CM | CROMO MATE |
| FOGI.O | ORO |

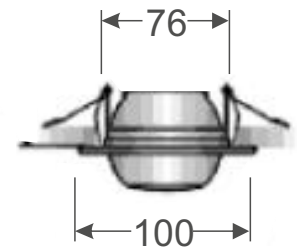

| CHAPA BASCULANTE | |
|-------------------------|------------|
| REFERENCIA | COLOR |
| FOBA.B | BLANCO |
| FOBA.CM | CROMO MATE |
| FOBA.O | ORO |

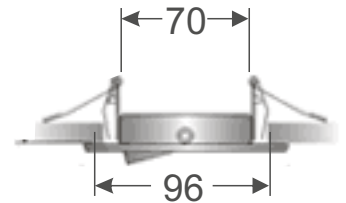

| ZAMAK FIJO | |
|-------------------|------------|
| REFERENCIA | COLOR |
| FOFI.BZ | BLANCO |
| FOFI.CMZ | CROMO MATE |
| FOFI.OZ | ORO |

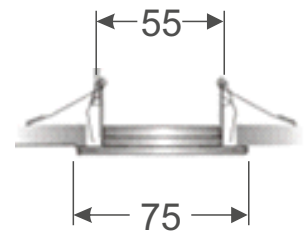

| ZAMAK BASCULANTE | |
|-------------------------|------------|
| REFERENCIA | COLOR |
| FOBA.BZ | BLANCO |
| FOBA.CMZ | CROMO MATE |
| FOBA.OZ | ORO |

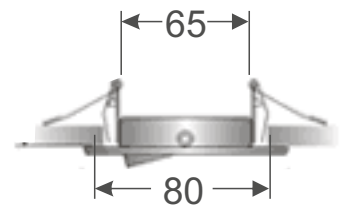

| ZAMAK CUADRADO | |
|-----------------------|------------|
| REFERENCIA | COLOR |
| FOCU.CM | CROMO MATE |

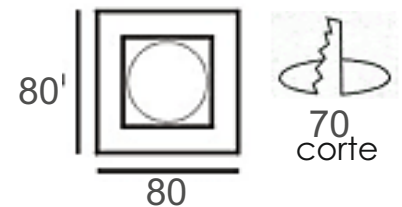

| ZAMAK CUADRADO | |
|-----------------------|------------|
| REFERENCIA | COLOR |
| FOCUB.CM | CROMO MATE |

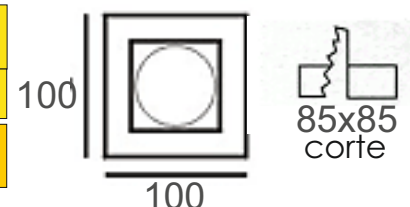

FOCO FIJO ESPECIAL EXTERIOR Y BAÑOS



- . Color Cromo Mate
- . Cristal Mate
- . Protección IP44
- . Junta de silicona

FOFIB.CM

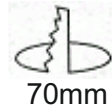

FOCO FIJO CRISTAL



Azul
FOFI.Z



Blanco
FOFI.BC



Verde
FOFI.V



Rosa
FOFI.R

ARO SUJECCIÓN DICROICAS



FOFI.A1



FOFI.A2

TRANSFORMADORES



Electrónico 12V-50W
TR.1250E



Electrónico
TR.1260 - 12V-60W
TR.12105 - 12V-105W
TR.12150 - 12V-150W



Electrónico especial Leds
TR.33 - 3,6V-3W-950mA
TR.123 - 12V-3W-650mA
TR.12.350 - 12V-3W-350mA
TR.24.10 - 24V-10W-350mA



Magnético 12V-50W
TR.1250

CAJA KIT



Todos los modelos de focos de empotrar pueden ir presentado en su "Caja Kit" Elija el foco, la bombilla, el portalámparas y el transformador.

YCKIT

FOCO EMPOTRABLE PARA BI-PIN 12V-20W. POLVERAS



| REFERENCIA | COLOR |
|----------------------------|-------|
| FOPO.O | ORO |
| <i>sin tapa de cristal</i> | |

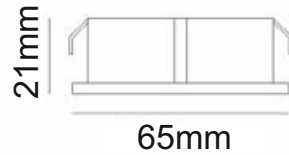

| REFERENCIA | COLOR |
|----------------------------|------------|
| FOPO.CM | CROMO MATE |
| <i>con tapa de cristal</i> | |

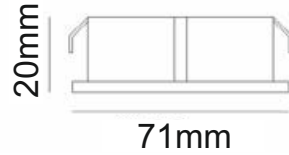

54mm

FOCOS PARA BOMBILLAS GX53



FOGX53.G - Aro superficie PVC gris (no incluye bombilla)

FOGX53.GK - Aro superficie PVC gris (con bombilla de 9w)

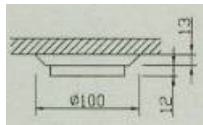

80mm

FOGX53.C - Aro empotrable cromo (no incluye bombilla)



BOMBILLAS GX53 BAJO CONSUMO VER PÁG.7
BOMBILLAS GX53 LEDS VER PÁG. 45

LEDS CON ARO EMPOTRABLE 3W

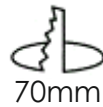

70mm

| REFERENCIA | HORAS | POTENCIA | NºLEDS | COLOR | EQUIPO |
|------------------|--------|----------|--------|--------|-----------|
| FOLED.3NM | 50.000 | 12V-3W | 3 | 4000°K | TR.12/350 |



LEDS CON ARO EMPOTRABLE 4W



75mm

| REFERENCIA | HORAS | POTENCIA | NºLEDS | COLOR | EQUIPO |
|------------------|--------|----------|--------|--------|--------------|
| FOLED.4CM | 30.000 | 220V-4W | 4 | 4000°K | DIRECTO 220V |





EMPOTRABLES PARA REFLECTORA • BAJO CONSUMO

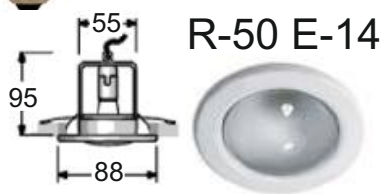

R-50 E-14

FOFI.R50 Blanco

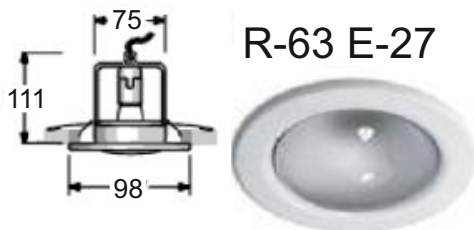

R-63 E-27

FOFI.R63 Blanco

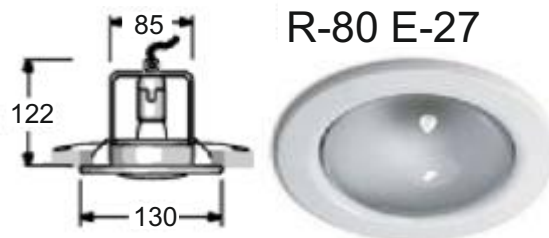

R-80 E-27

FOFI.R80 Blanco

Downlights Bajo Consumo

REDONDOS 2x26W incluye: aro + cristal + equipo magnético



FOPL.26B - Aro Blanco + Cristal Transparente

FOPL.26BM - Aro Blanco + Cristal Mate

FOPL.26N - Aro Níquel Brillante + Cristal Transparente

FOPL.26NM - Aro Níquel Brillante + Cristal Mate

FOPL.26CM - Aro Cromo Mate + Cristal Mate

FOPL.26CMM - Aro Cromo Mate + Cristal Transparente



G24d-3



200mm.

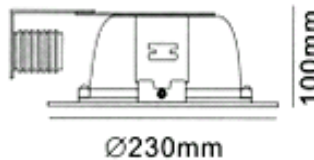

Ø230mm

100mm



2 x 26w

REDONDOS 2x13W incluye: aro + cristal + equipo magnético



FOPL.13B - Aro Blanco + Cristal Transparente

FOPL.13BM - Aro Blanco + Cristal Mate

FOPL.13NM - Aro Níquel Brillante + Cristal Transparente

FOPL.13NMM - Aro Níquel Brillante + Cristal Mate



G24d-1

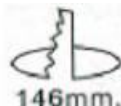

146mm.

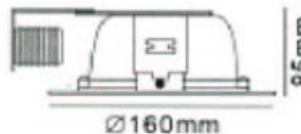

Ø160mm

85mm



2 x 13w

CUADRADOS 2x26W incluye: aro + cristal + equipo magnético



FOPL.26CU.BM - Aro Blanco + Cristal Mate

FOPL.26CU.NM - Aro Níquel Mate + Cristal Transparente

FOPL.2CU.NMM - Aro Níquel Mate + Cristal Mate



G24d-3

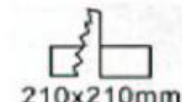

210x210mm

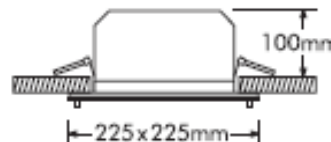

←225x225mm→

100mm



2 x 26w

REDONDOS 2xE27 para bombillas de rosca E-27 incluye: aro + cristal



FOPL.27BM - Aro Blanco + Cristal Mate



CRISTALES RECAMBIO

FOPL.26RT - Redondo 2x26w Transparente

FOPL.26RM - Redondo 2x26w Mate

FOPL.13RT - Redondo 2x13w Transparente

FOPL.26RCUT - Cuadrado 2x26w Transparente

FOPL.26RCUM - Cuadrado 2x26w Mate

FOPL.13RM - Redondo 2x13w Mate

EQUIPOS ENCAPSULADOS PARA DOWNLIGHTS



FOPL.26E - Equipo Magnético 2x26w Encapsulado

FOPL.26EQ - Equipo Electrónico 2x26w Encapsulado

FOPL.13E - Equipo Magnético 2x13w Encapsulado

BOMBILLAS PARA DOWNLIGHT



Bombilla PL-C 26w/4000°K G24d3
Bombilla PL-C 13w/4000°K G24d1

Ver página 9 - Iluminación



Bombilla E27
Diferentes modelos
Ver página 6 - Iluminación



Bombilla 44 Leds
Casquillo G24d3
Color 4000°K
Directa a 220V.

Ver página 43 - Iluminación

DOWNLIGHT LED

Downlight Empotrable de Leds

. Potencia: 18W . Voltaje: DC-24V 50/60Hz .

Luminosidad: 1050-1180Lm

. Equipo incluido 35-42V DC 400mA

. Extraplano. Medidas ext.: Ø225mm x 15mm .

Color 4200°K . IP40

. Vida: 30.000 horas

FOLE.18/4B - Aro Blanco ; Cristal Mate

FOLE.18/4CM - Aro Cromo Mate ; Cristal Mate



Focos para Halogenuros

Focos Empotrables

Proyector Empotrable. Color Blanco. No incluye equipo



Para halogenuro de 70w o halógena lineal 118mm
FOHM70

Para halogenuro de 150w
FOHM150

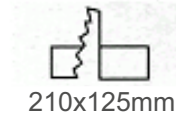

Para halogenuro de 70w o halógena lineal 118mm
FOHM70C Circular

Para halogenuro de 150w
FOHM150C Circular

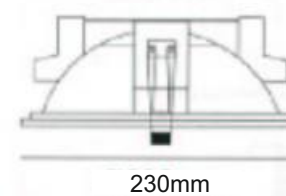
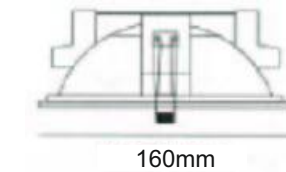

Equipos Halogenuros

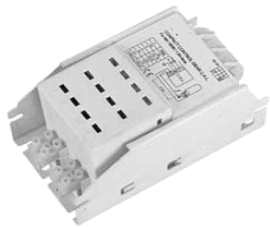

mevi.17470 - Para halogenuro de 70w - Medidas 134x74x68mm

mevi.174150 - Para halogenuro de 150w - Medidas 154x86x78mm

Focos Superficie

Proyector Superficie con base. Color Blanco. Incluye equipo



ilin.83070 - Para halogenuro de 70w

ilin.83150 - Para halogenuro de 150w

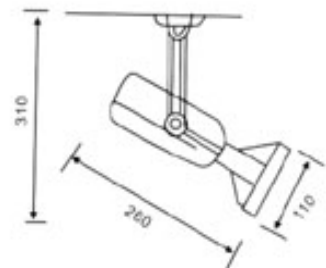

Bombillas Halogenuros

| REFERENCIA | WATIOS | COLOR | LONGITUD | CASQUILLO |
|------------------|--------|---------------|----------|-----------|
| BHQI.70 | 70W | FRIO=4000°K | 118mm | RX7s |
| BHQI.70C | 70W | CALIDO=2700°K | 118mm | RX7s |
| BHQI.150 | 150W | FRIO=4000°K | 135mm | RX7s |
| BHQI.150C | 150W | CALIDO=2700°K | 135mm | RX7s |



REGLETAS MINI FLUORESCENTES

Extra Plana

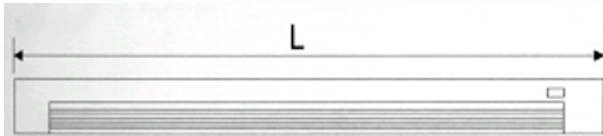

- . Cable de conexión a 230V/50Hz
- . Cable de autoconexión
- . Reactancia electrónica
- . Fluorescente T5 6500°K incluido
- . Interruptor . Kit de montaje

| REFERENCIA | POTENCIA | H | W | L |
|-------------------|----------|------|------|-------|
| ILIN.42068 | 8W | 68mm | 20mm | 342mm |
| ILIN.42061 | 13W | 68mm | 20mm | 555mm |

Mini



- . Cable de conexión a 230V/50Hz
- . Cable de autoconexión
- . Reactancia electrónica
- . Fluorescente T5 6500°K incluido
- . Interruptor
- . Kit de montaje

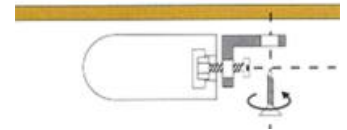

| REFERENCIA | POTENCIA | H | W | L |
|-------------------|----------|------|------|-------|
| ILIN.42036 | 6W | 43mm | 22mm | 283mm |
| ILIN.42038 | 8W | 43mm | 22mm | 353mm |
| ILIN.42031 | 13W | 43mm | 22mm | 583mm |

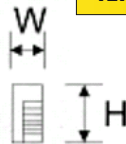
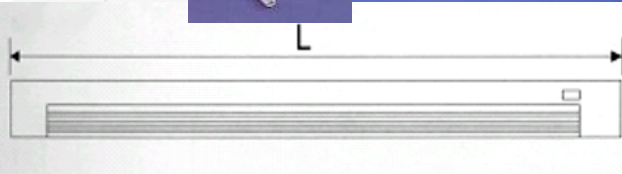

EXTRA-PLANA. ELECTRONICA

- . Cuerpo metálico. Puntas plástico.
- . Accesorios de fijación incluidos.



| REFERENCIA | POTENCIA | H | W | L |
|-------------------|----------|------|------|--------|
| ILIN.42020 | 20W | 55mm | 37mm | 697mm |
| ILIN.42040 | 40W | 55mm | 37mm | 1308mm |

REGLETA DECORATIVA

- . Pantalla con difusor. . Para 2 tubos.
- . Reactancia Electrónica 230V - 50/60Hz



| REFERENCIA | NºTUBOS | POTENCIA | L |
|-------------------|---------|----------|--------|
| ILIN.45218 | 2 | x 18W | 725mm |
| ILIN.45236 | 2 | x 36W | 1330mm |



REGLETA INDUSTRIAL ELECTRONICA

- . Chapa metálica.
- . 230V - 50/60Hz



| ELECTRONICA | MAGNETICA | NºTUBOS | POTENCIA | MEDIDA TUBO |
|-------------------|-------------------|---------|----------|-------------|
| | ILIN.41118 | 1 | x 18W | 60cms |
| | ILIN.41136 | 1 | x 36W | 120cms |
| | ILIN.41158 | 1 | x 58W | 150cms |
| ILIN.42218 | ILIN.42218 | 2 | x 18W | 60cms |
| ILIN.42236 | ILIN.42236 | 2 | x 36W | 120cms |
| | ILIN.41258 | 2 | x 58W | 120cms |

REACTANCIAS

| ELECTRONICA | MAGNETICA | DESCRIPCIÓN |
|-------------------|-------------------|---------------------|
| ILIN.42100 | ILIN.40118 | Para 1 tubo de 18w |
| ILIN.42101 | ILIN.40136 | Para 1 tubo de 36w |
| ILIN.42102 | ILIN.40158 | Para 1 tubo de 58w |
| | ILIN.40132 | Para 1 tubo de 32w |
| ILIN.42103 | | Para 2 tubos de 18w |
| ILIN.42104 | | Para 2 tubos de 36w |



REGLETA ESTANCA IP65

- . Base ABS. Difusor PC (Poli-Carbonato)
- . Garras metálicas.
- . Sujeción anti-caída difusor.
- . Protección IP65
- . 230V - 50/60Hz

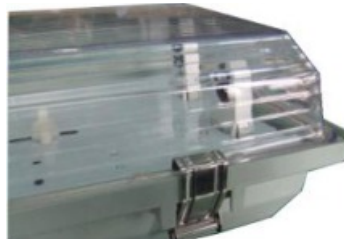

Clip metálico
sujeción difusor
ILIN.44001



Accesorio colgador
Para pantallas de 1 tubo
Kit 2 piezas.
ILIN.43117

Accesorio colgador
Para pantallas
de 2 tubos
Kit 2 piezas.
ILIN.43217

| ELECTRONICA | MAGNETICA | NºTUBOS | POTENCIA | MEDIDA TUBO |
|-------------------|-------------------|---------|----------|-------------|
| ILIN.43118 | ILIN.44118 | 1 | x 18W | 60cms |
| | ILIN.44136 | 1 | x 36W | 120cms |
| ILIN.43158 | ILIN.44158 | 1 | x 58W | 150cms |
| ILIN.43218 | ILIN.44218 | 2 | x 18W | 60cms |
| | ILIN.44236 | 2 | x 36W | 120cms |
| | ILIN.44258 | 2 | x 58W | 150cms |

FOCOS PARA REFLECTORAS



| REFERENCIA | COLOR | BOMBILLA |
|-------------------|--------|----------|
| ILIN.50440 | BLANCO | R63 |
| ILIN.50441 | NEGRO | R80 |
| ILIN.50442 | PLATA | R63 |



| REFERENCIA | COLOR | BOMBILLA |
|--------------------|--------|----------|
| ILIN.521010 | BLANCO | R63 |
| ILIN.521011 | NEGRO | R63 |
| ILIN.521012 | PLATA | R80 |

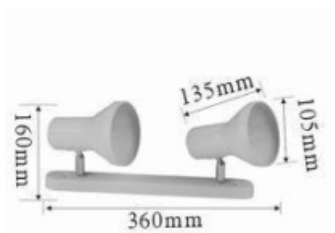

| REFERENCIA | COLOR | BOMBILLA |
|--------------------|--------|----------|
| ILIN.521020 | BLANCO | R80 |
| ILIN.521021 | NEGRO | R80 |
| ILIN.521022 | PLATA | R63 |

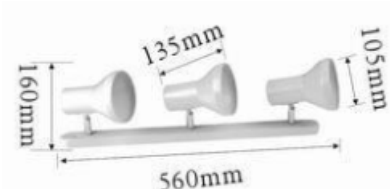

| REFERENCIA | COLOR | BOMBILLA |
|--------------------|--------|----------|
| ILIN.521030 | BLANCO | R80 |
| ILIN.521031 | NEGRO | R63 |
| ILIN.521032 | PLATA | R80 |



| REFERENCIA | COLOR | BOMBILLA |
|--------------------|--------|----------|
| ILIN.522020 | BLANCO | R80 |
| ILIN.522021 | NEGRO | R80 |
| ILIN.522022 | PLATA | R80 |



| REFERENCIA | COLOR | BOMBILLA |
|--------------------|--------|----------|
| ILIN.522030 | BLANCO | R80 |
| ILIN.522031 | NEGRO | R63 |
| ILIN.522032 | PLATA | R80 |



FLEXOS SOBREMESA



| REFERENCIA | COLOR |
|------------|--------|
| ILIN.50350 | BLANCO |
| ILIN.50351 | NEGRO |
| ILIN.50356 | ROJO |



| REFERENCIA | COLOR |
|-------------|----------|
| ILIN.520233 | AMARILLO |
| ILIN.520237 | NARANJA |
| ILIN.520238 | VERDE |



| REFERENCIA | COLOR |
|------------|-------|
| ILIN.50051 | NEGRO |

"Con posa-lápices"



| REFERENCIA | COLOR |
|------------|----------|
| ILIN.50072 | GRIS |
| ILIN.50073 | AMARILLO |
| ILIN.50074 | AZUL |
| ILIN.50076 | ROJO |
| ILIN.50078 | VERDE |



| REFERENCIA | COLOR |
|------------|--------|
| ILIN.50400 | BLANCO |
| ILIN.50401 | NEGRO |
| ILIN.50406 | ROJO |



| REFERENCIA | COLOR |
|------------|----------|
| ILIN.50170 | BLANCO |
| ILIN.50171 | NEGRO |
| ILIN.50172 | GRIS |
| ILIN.50173 | AMARILLO |
| ILIN.50174 | AZUL |
| ILIN.50176 | ROJO |
| ILIN.50178 | VERDE |

FLEXO EXTENSIBLE A PARED E-27

| REFERENCIA | COLOR |
|------------|-------|
| ILIN.52006 | GRIS |

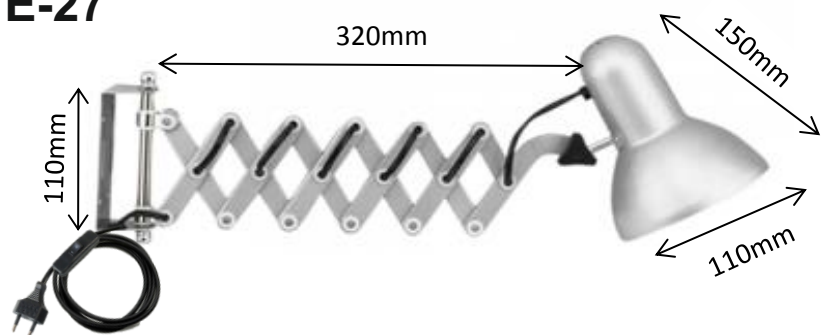



E-27

| REFERENCIA | COLOR |
|------------------|-------|
| ILIN.5132 | GRIS |



E-27

| REFERENCIA | COLOR |
|--------------------|----------|
| ILIN.5115.0 | BLANCO |
| ILIN.5115.1 | NEGRO |
| ILIN.5115.2 | GRIS |
| ILIN.5115.3 | AMARILLO |
| ILIN.5115.4 | AZUL |
| ILIN.5115.7 | NARANJA |
| ILIN.5115.8 | VERDE |



E-27

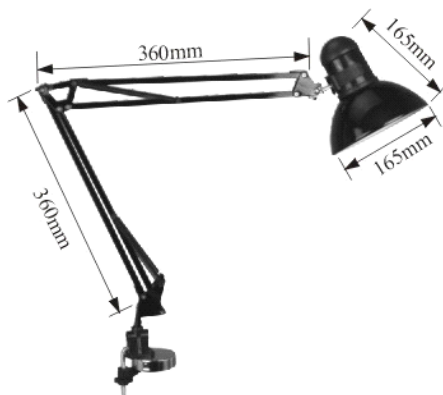

| REFERENCIA | COLOR |
|-------------------|--------|
| ILIN.50380 | BLANCO |
| ILIN.50381 | NEGRO |
| ILIN.50382 | PLATA |



E-27

| REFERENCIA | COLOR |
|-------------------|--------------|
| ILIN.51242 | GRIS-GRAFITO |

FLEXOS SOBREMESA HALOGENOS



extensible

BI-PIN 20W

| REFERENCIA | COLOR |
|---------------------|-------------------------|
| ILIN.5129.00 | BLANCO |
| ILIN.5129.02 | GRIS |
| ILIN.5129.04 | AZUL |
| ILIN.5129.06 | ROJO |
| ILIN.5129.08 | VERDE |
| ILIN.5129.13 | AMARILLO TRASPARENTE |



BI-PIN 35W

| REFERENCIA | COLOR |
|-------------------|-------|
| ILIN.58016 | ROJO |

Tentempie Anti-caidas

BI-PIN 20W



| REFERENCIA | COLOR |
|--------------------|----------|
| ILIN.5151.3 | AMARILLO |
| ILIN.5151.4 | AZUL |
| ILIN.5151.6 | ROJO |
| ILIN.5151.7 | LILA |
| ILIN.5151.8 | VERDE |



BI-PIN 35W

| REFERENCIA | COLOR |
|--------------------|------------|
| ILIN.510349 | PLATA-LILA |



BI-PIN 35W

| REFERENCIA | COLOR |
|--------------------|-------------|
| ILIN.510291 | PLATA-NEGRO |
| ILIN.510294 | PLATA-AZUL |
| ILIN.510295 | PLATA |
| ILIN.510296 | PLATA-ROJO |



| REFERENCIA | COLOR |
|--------------------|-------------|
| ILIN.570504 | AZUL |



| REFERENCIA | COLOR |
|--------------------|-------------|
| ILIN.570124 | AZUL |

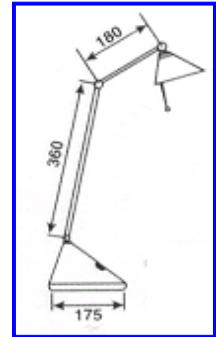
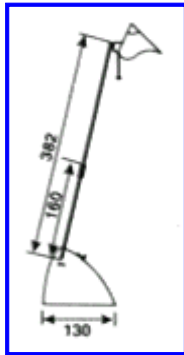

| REFERENCIA | COLOR |
|---------------------|------------------------|
| ILIN.5106.13 | BLANCO-AMARILLO |
| ILIN.5106.14 | BLANCO-AZUL |
| ILIN.5106.16 | BLANCO-ROJO |
| ILIN.5106.18 | BLANCO-VERDE |

| REFERENCIA | COLOR |
|---------------------|--------------------|
| ILIN.5101.51 | PLATA-NEGRO |
| ILIN.5101.52 | PLATA-GRIS |



| REFERENCIA | COLOR |
|-------------------|---------------|
| ILIN.51101 | NEGRO |
| ILIN.51104 | AZUL |
| ILIN.51106 | ROJO |
| ILIN.51108 | VERDE |
| ILIN.51109 | MARRON |



FLEXOS SOBREMESA BAJO CONSUMO



PL-11w

| REFERENCIA | COLOR |
|--------------------|--------|
| ILIN.510010 | BLANCO |
| ILIN.510011 | NEGRO |

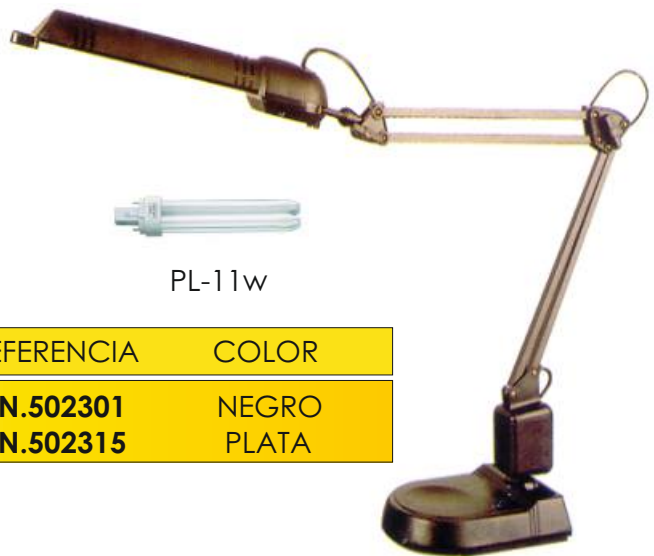

PL-11w

| REFERENCIA | COLOR |
|--------------------|-------|
| ILIN.502301 | NEGRO |
| ILIN.502315 | PLATA |



PL-11w

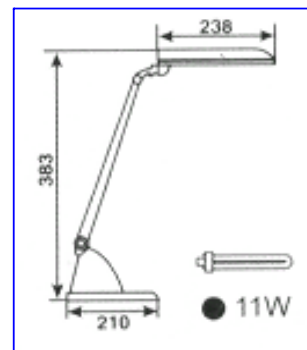

| REFERENCIA | COLOR |
|--------------------|-------|
| ILIN.501401 | NEGRO |
| ILIN.501451 | PLATA |

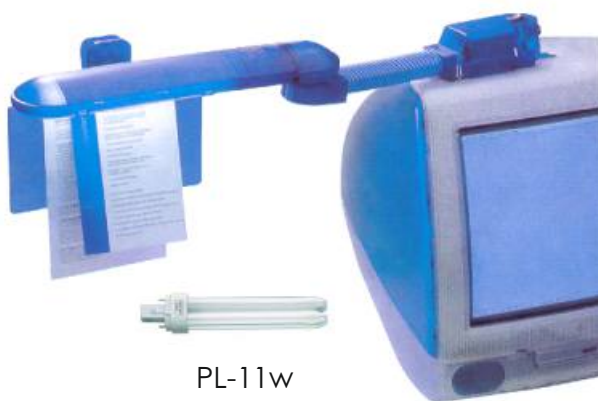

PL-11w

| REFERENCIA | COLOR |
|---------------------|---------|
| ILIN.5025.00 | BLANCO |
| ILIN.5025.14 | AZUL |
| ILIN.5025.16 | ROJO |
| ILIN.5025.17 | NARANJA |
| ILIN.5025.18 | VERDE |

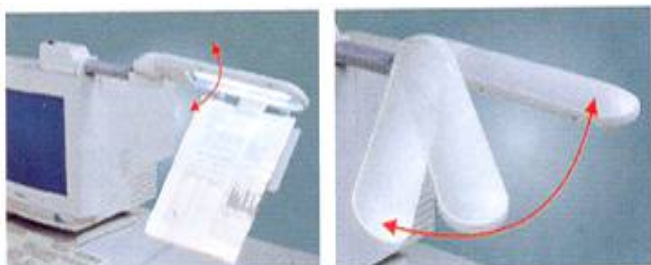

- . Colores translucidos
- . 2 Bases adhesivas
- . Pinza con soporte para papeles
- . Tija flexible
- . Foco orientable
- . Interruptor ON/OFF

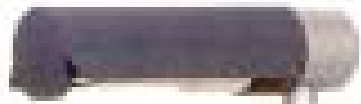
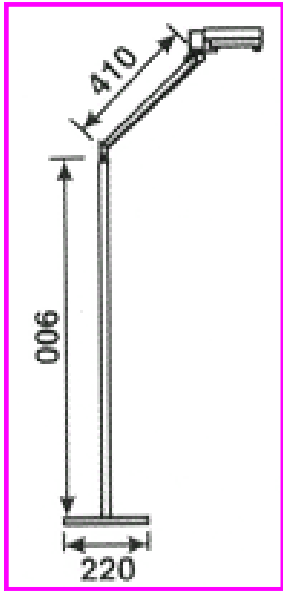
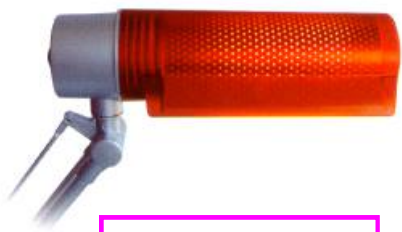

PIE

| REFERENCIA | COLOR |
|------------|-------|
|------------|-------|

| | |
|-------------|----------|
| ILIN.545121 | NEGRO |
| ILIN.545123 | AMARILLO |
| ILIN.545124 | AZUL |
| ILIN.545127 | ROSA |
| ILIN.545128 | VERDE |

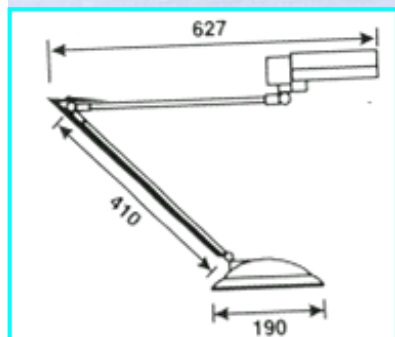

SOBREMESA

| REFERENCIA | COLOR |
|------------|-------|
|------------|-------|

| | |
|-------------|-------|
| ILIN.545021 | NEGRO |
| ILIN.545024 | AZUL |
| ILIN.545027 | ROSA |
| ILIN.545028 | VERDE |



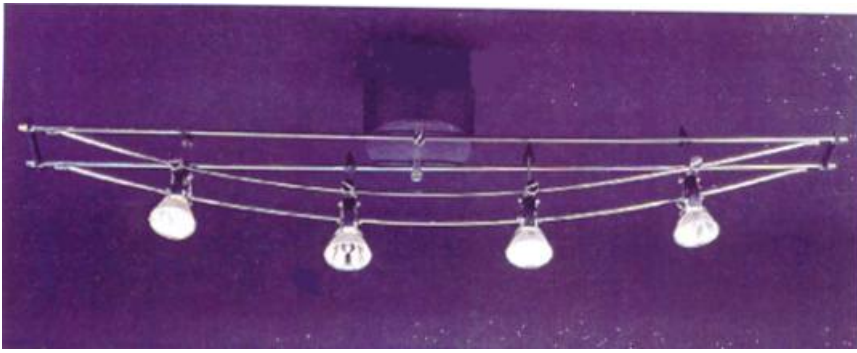

| REFERENCIA | COLOR |
|------------------|-------------|
| ILIN.5011 | NEGRO-METAL |

- . Plafón techo
- . Base con transformador
- . Bombillas incluidas

| REFERENCIA | COLOR |
|--------------------|--------|
| ILIN.538120 | BLANCO |
| ILIN.538121 | NEGRO |

PIES DE SALON



- . Para halógena lineal 300w
- . Color gris con ribetes dorados
- . Regulador de pie

ILIN.56004



E-27

- . Para bombillas E-27
- . Color cromado
- . Tulipa plástico mate

ILIN.56007



ILUMINACION EXTERIOR

PROYECTORES HALÓGENOS

Material: Fundición de aluminio. IP44. Aislamiento CLASE I



| REFERENCIA | POTENCIA | COLOR |
|---|----------|--------|
| ILEX.86530 | 500W | BLANCO |
| ILEX.86531 | 500W | NEGRO |
| incluye halógena 500w 118mm  | | |

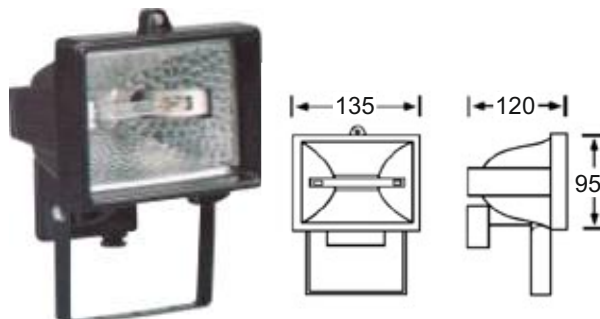

| REFERENCIA | POTENCIA | COLOR |
|--|----------|--------|
| ILEX.86150 | 150W | BLANCO |
| ILEX.86151 | 150W | NEGRO |
| incluye halógena 150w 78mm  | | |

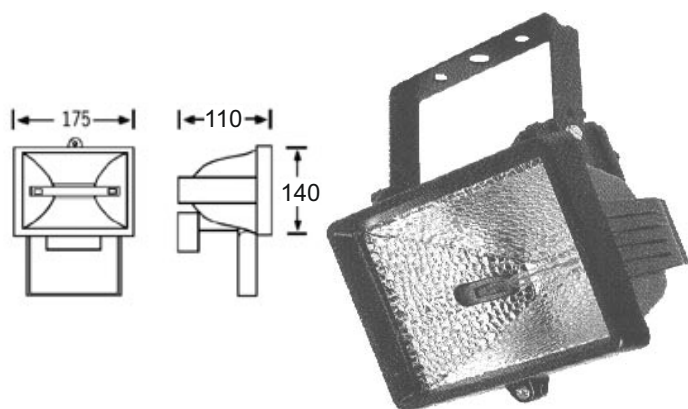

| REFERENCIA | POTENCIA | COLOR |
|---|----------|--------|
| ILEX.86500 | 500W | BLANCO |
| ILEX.86501 | 500W | NEGRO |
| ILEX.86502 | 500W | GRIS |
| incluye halógena 500w 118mm  | | |



| REFERENCIA | POTENCIA | COLOR |
|---|----------|-------|
| ILEX.86509 | 500W | NEGRO |
| incluye halógena 500w 118mm  | | |



| REFERENCIA | POTENCIA | COLOR |
|---|----------|-------|
| ILEX.86510 | 500W | NG/AM |
| incluye halógena 500w 118mm  | | |

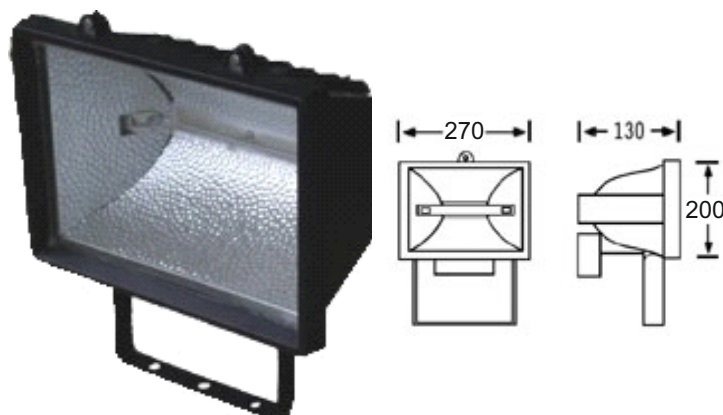



| REFERENCIA | POTENCIA | COLOR |
|---|----------|-------|
| ILEX.86101 | 1.000W | NEGRO |
| incluye halógena 1.000w 189mm  | | |



| REFERENCIA | POTENCIA | COLOR |
|---|----------|-------|
| ILEX.86511 | 500W | NG/AM |
| incluye halógena 500w 118mm  | | |



| REFERENCIA | POTENCIA | COLOR |
|--|----------|-------|
| ILEX.86512 | 2x500W | NG/AM |
| incluye 2 halógenas 500w 118mm  | | |



PROYECTOR BAJO CONSUMO

- . IP44 . Fabricado en PVC y marco de cristal
- . Incluye bombilla bajo consumo 80w 6500°K (Ref.BPLEX80/6)
- . Medidas 33 x 22,5 x 12 cms

ILEX.86180

Sustitutas Halógena Lineal (para proyectores)



Bajo Consumo

Duración: 8.000 horas

Sustituta Halógena Lineal 78mm. Para focos R7s 150w
 220V-240V - 50Hz - 12W - 720Lm
BPL.EX12/3 - 3000°K **BPL.EX12/6** - 6500°K

Sustituta Halógena Lineal 118mm. Para focos R7s 500w
 220V-240V - 50Hz - 20W - 1200Lm
BPL.EX20/3 - 3000°K **BPL.EX20/6** - 6500°K

Sustituta Halógena Lineal 189mm. Para focos R7s 1000w
 220V-240V - 50Hz - 20W - 2400Lm
BPL.EX40/3 - 3000°K **BPL.EX40/6** - 6500°K



LEDS

Duración: 20.000 horas

Sustituta Halógena Lineal 118mm.
 Para focos R7s 500w
 220V-240V - 50Hz - 6W - 360Lm - 92 Leds
BLED.EX6 - 4000°K

Duración: 50.000 horas
 Sustituta Halógena Lineal 118mm.
 Para focos R7s 500w
 220V-240V - 50Hz - 8W - 720Lm - 36 Leds
BLED.EX8/4 - 4000°K **BLED.EX8/6** - 6000°K

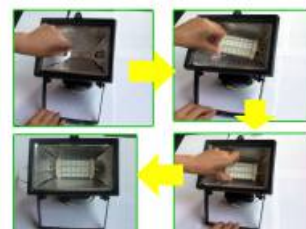

LED

PROYECTORES LED

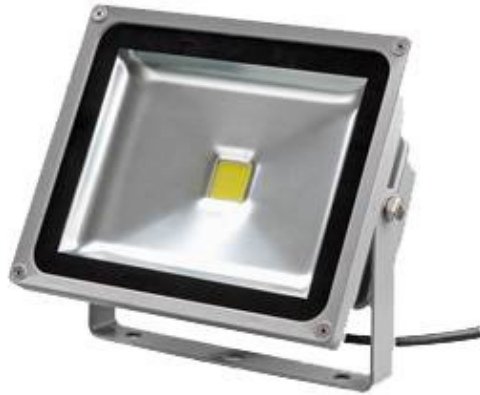

Material: Aluminio + cristal
 Duración: 50.000 horas
 Color: 6000°K
 IP65 - Exterior

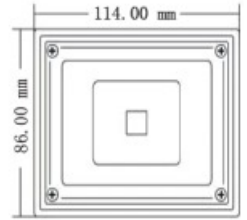
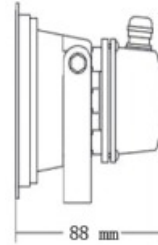

| REFERENCIA | POTENCIA | LUMENS | MEDIDAS (AxBxC) |
|-------------------|----------|--------|-----------------|
| ILEX.86152 | 10W | 730 | 114x86x88mm |
| ILEX.86503 | 30W | 2336 | 225x185x124mm |
| ILEX.86102 | 50W | 3271 | 287x237x180mm |

Ver iluminación Led
 Página 59

PROYECTORES HALÓGENUROS METÁLICOS

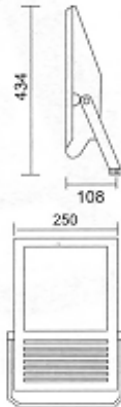

| REFERENCIA | POTENCIA | COLOR |
|----------------------------|----------|-------|
| ILEX.85075 | 70W | NEGRO |
| ILEX.85155 | 150W | NEGRO |
| <i>no incluye bombilla</i> | | |

BOMBILLAS HALOGENURO METÁLICO

| REFERENCIA | WATIOS | COLOR | LONGITUD | CASQUILLO |
|------------------|--------|---------------|----------|-----------|
| BHQI.70 | 70W | FRIO=4000°K | 118mm | RX7s |
| BHQI.70C | 70W | CALIDO=2700°K | 118mm | RX7s |
| BHQI.150 | 150W | FRIO=4000°K | 135mm | RX7s |
| BHQI.150C | 150W | CALIDO=2700°K | 135mm | RX7s |

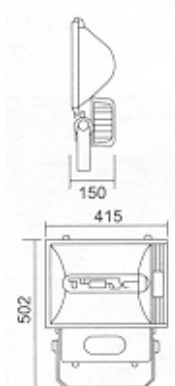

| REFERENCIA | POTENCIA | COLOR |
|-------------------------|----------|-------|
| ILEX.85250 | 250W | NEGRO |
| ILEX.85400 | 400W | NEGRO |
| <i>incluye bombilla</i> | | |



HPI-T. E-40

FAROLES

Material: Aluminio inyectado
 Protección IP33
 Portalámparas E-27 cerámico



| REFERENCIA | COLOR |
|-------------------|--------|
| ILEX.86190 | BLANCO |
| ILEX.86191 | NEGRO |

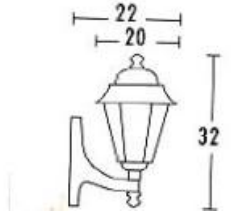

| REFERENCIA | COLOR |
|-------------------|--------|
| ILEX.86193 | BLANCO |
| ILEX.86194 | NEGRO |

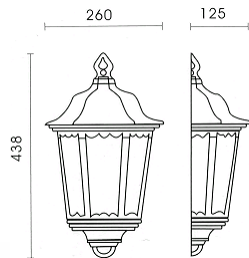

| REFERENCIA | COLOR |
|-------------------|--------|
| ILEX.86210 | BLANCO |
| ILEX.86211 | NEGRO |

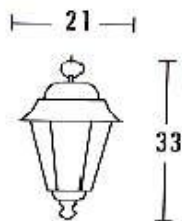

| REFERENCIA | COLOR |
|-------------------|--------|
| ILEX.86220 | BLANCO |
| ILEX.86221 | NEGRO |

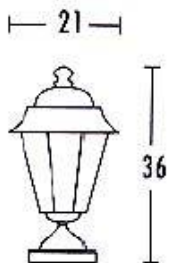
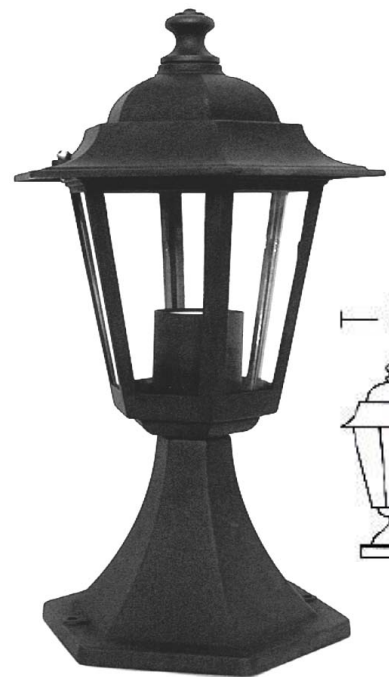

| REFERENCIA | COLOR |
|-------------------|--------|
| ILEX.86200 | BLANCO |
| ILEX.86201 | NEGRO |

APLIQUE EMPOTRAR PARED

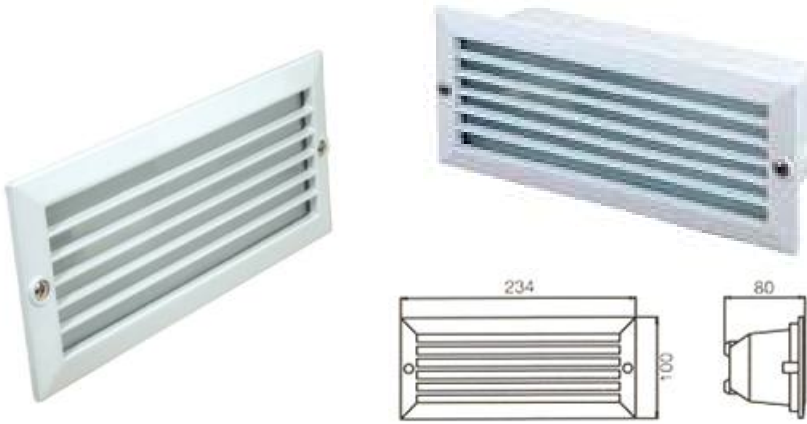

Material: Fundición aluminio y cristal (mate)
 Portalámparas E27 "cerámico"
 Protección IP44. Clase I
 No incluye caja de empotrar

| REFERENCIA | COLOR |
|------------|-------|
|------------|-------|

| | |
|-------------------|--------|
| ILEX.81500 | BLANCO |
| ILEX.81501 | NEGRO |

APLIQUE EMPOTRAR SUELO



Material: Fundición aluminio y cristal (transparente)
 Portalámparas E27 "cerámico"
 Protección IP65. Clase I

| REFERENCIA | COLOR |
|------------|-------|
|------------|-------|

| | |
|-------------------|--------|
| ILEX.82500 | BLANCO |
| ILEX.82501 | NEGRO |

LUMINARIA DE PIE



Material: Fundición aluminio y PVC (mate)
 Portalámparas E27
 Protección IP44. Clase I

| REFERENCIA | COLOR | ALTURA |
|------------|-------|--------|
|------------|-------|--------|

| | | |
|-------------------|--------|---------|
| ILEX.82100 | BLANCO | 65 cms |
| ILEX.82101 | NEGRO | 103 cms |

EMPOTRABLE SOLAR CON LED



Sin instalación
Funciona por recarga solar

Medidas: Ø120 x 35mm

ILEX.82503

Material: Acero Inoxidable
 3 Leds
 Hasta 8 horas de uso por carga
 Batería recargable Ni-Mh incluida
 Protección IP44.

FOCO EXTERIOR CON REJILLA

REFERENCIA

ILEX.86557 CRISTAL RECAMBIO

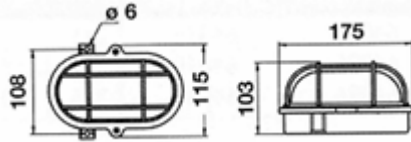

Material: PVC + Cristal
 Protección IP44
 Portalámparas E-27 cerámico



REFERENCIA COLOR

ILEX.86551 NEGRO

REFERENCIA COLOR

ILEX.86550 BLANCO

REFERENCIA COLOR

ILEX.86555 REJILLA ACERO

REFERENCIA

ILEX.86557 CRISTAL RECAMBIO



Material: PVC + Cristal
 Protección IP44
 Portalámparas E-27 cerámico

REFERENCIA COLOR

ILEX.86560 BLANCO

ILEX.86561 NEGRO

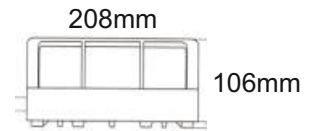

FOCO EXTERIOR BAJO CONSUMO

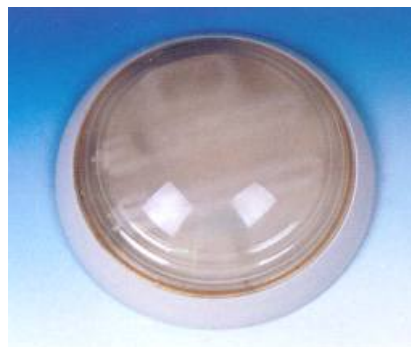
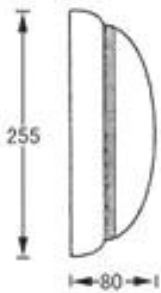

Material: Policarbonato
 Protección IP44
 Para 2 bombillas PL-S 9w

incluye bombillas y equipo

REFERENCIA COLOR

ILEX.87110 BLANCO

APLIQUE BOLA CRISTAL

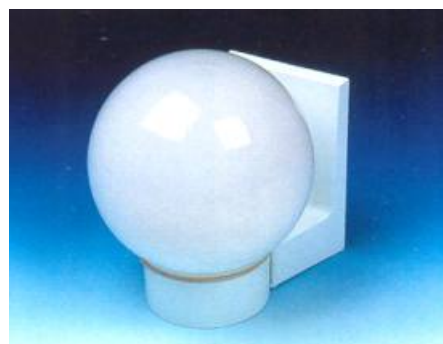
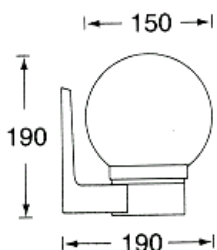

Material: PVC+ Cristal
 Protección IP44
 Portalámparas E-27

REFERENCIA COLOR

ILEX.81920 BLANCO

ILEX.81921 NEGRO



Material: Aluminio + Cristal
 Protección IP54
 Portalámparas E-27 cerámico

| REFERENCIA | COLOR |
|-------------------|--------|
| ILEX.81070 | BLANCO |
| ILEX.81071 | NEGRO |

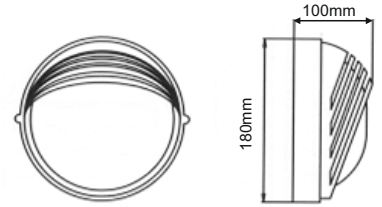

Material: Aluminio + Cristal
 Protección IP54
 Portalámparas E-27 cerámico

| REFERENCIA | COLOR |
|-------------------|--------|
| ILEX.81080 | BLANCO |
| ILEX.81081 | NEGRO |

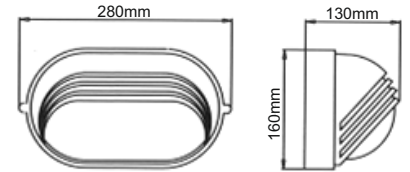

Material: Aluminio + Cristal
 Protección IP54
 Portalámparas E-27 cerámico

| REFERENCIA | COLOR |
|-------------------|-------|
| ILEX.81181 | NEGRO |

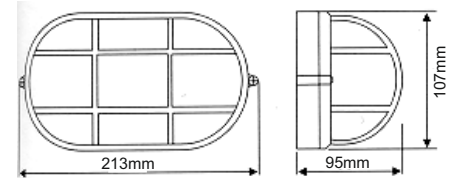

Material: Aluminio + Cristal
 Protección IP44
 Portalámparas E-27 cerámico

| REFERENCIA | COLOR |
|-------------------|--------|
| ILEX.81915 | BLANCO |
| ILEX.81916 | NEGRO |

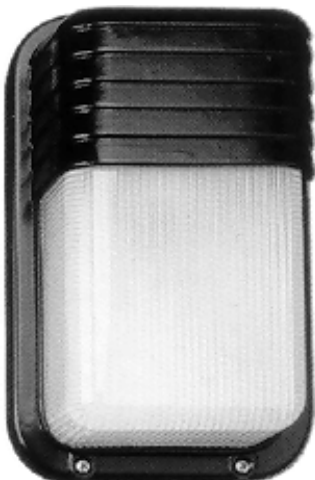
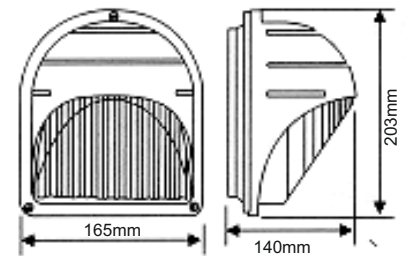

Material: Aluminio + PVC
 Protección IP54
 Portalámparas E-27 cerámico

| REFERENCIA | COLOR |
|-------------------|--------|
| ILEX.81904 | BLANCO |
| ILEX.81905 | NEGRO |

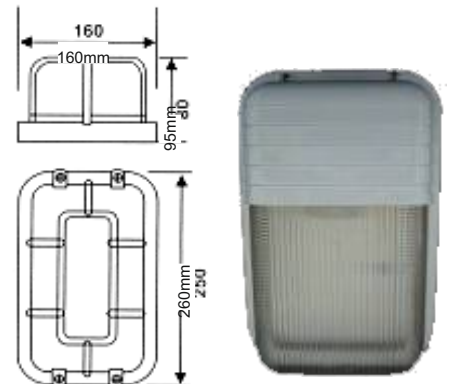

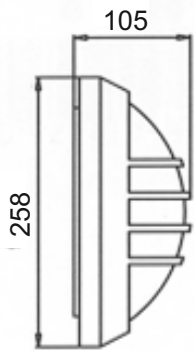

Material: Aluminio + Cristal
 Protección IP44
 Portalámparas E-27 cerámico

| REFERENCIA | COLOR |
|-------------------|--------|
| ILEX.82040 | BLANCO |
| ILEX.82041 | NEGRO |

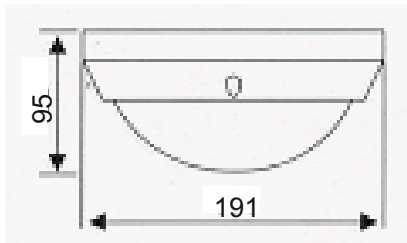

Material: Aluminio + Cristal
 Protección IP44
 Portalámparas E-27 cerámico

| REFERENCIA | COLOR |
|-------------------|--------|
| ILEX.82042 | BLANCO |
| ILEX.82043 | NEGRO |

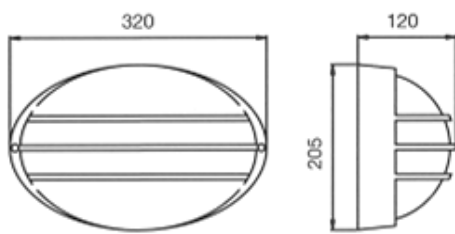

Material: Aluminio + Cristal
 Protección IP54
 Portalámparas E-27 cerámico

| REFERENCIA | COLOR |
|-------------------|--------|
| ILEX.82050 | BLANCO |
| ILEX.82051 | NEGRO |

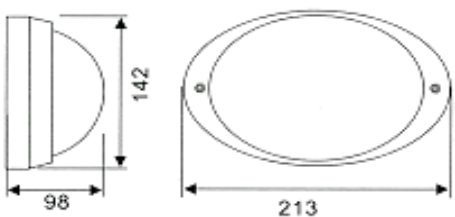

Material: Aluminio + Cristal
 Protección IP54
 Portalámparas E-27 cerámico

| REFERENCIA | COLOR |
|-------------------|--------|
| ILEX.82052 | BLANCO |
| ILEX.82053 | NEGRO |

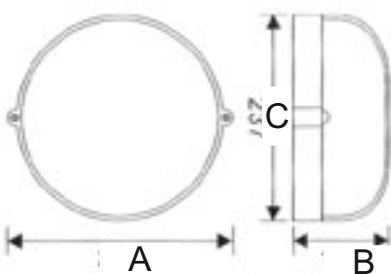

Material: Aluminio + Cristal
 Protección IP54
 Portalámparas E-27 cerámico

| REFERENCIA | COLOR | MEDIDAS AxBxC |
|--------------------|-------|------------------|
| ILEX.81509 | GRIS | 240x109x237 |
| REFERENCIA | COLOR | MEDIDAS AxBxC |
| ILEX.81062 | GRIS | 195x86x178 |
| ILEX.81062N | NEGRO | 195x86x178 |





Material: Aluminio + Cristal
 Protección IP54
 Portalámparas E-27 cerámico

| REFERENCIA | COLOR |
|-------------------|--------|
| ILEX.81065 | BLANCO |
| ILEX.81066 | NEGRO |

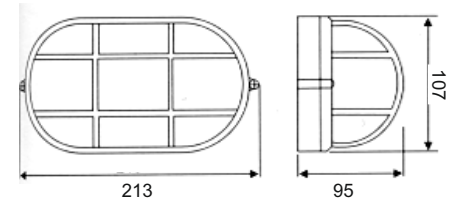

Material: Aluminio + Cristal
 Protección IP54
 Portalámparas E-27 cerámico

| REFERENCIA | COLOR |
|-------------------|--------|
| ILEX.81801 | BLANCO |

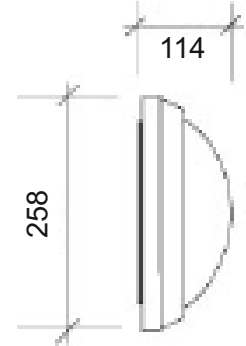

Material: Aluminio + Cristal
 Protección IP44
 Portalámparas E-27 cerámico

| REFERENCIA | COLOR |
|-------------------|--------|
| ILEX.81102 | BLANCO |
| ILEX.81103 | NEGRO |

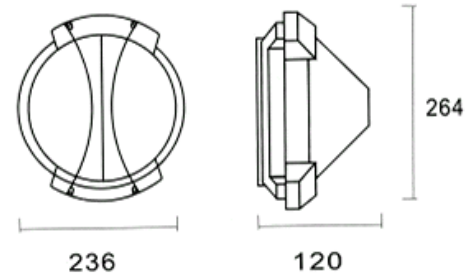

Material: Aluminio + Cristal
 Protección IP44
 Portalámparas E-27 cerámico

| REFERENCIA | COLOR |
|-------------------|--------|
| ILEX.81120 | BLANCO |
| ILEX.81121 | NEGRO |

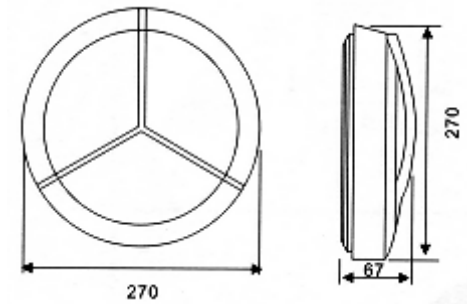

Material: Aluminio + Cristal
 Protección IP44
 Portalámparas E-27 cerámico

| REFERENCIA | COLOR |
|-------------------|--------|
| ILEX.81072 | BLANCO |
| ILEX.81073 | NEGRO |

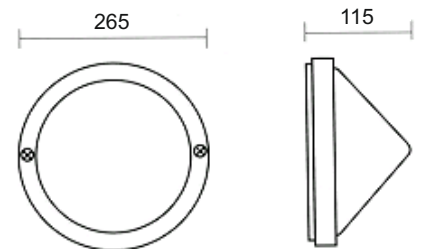

Material: Aluminio + Cristal
 Protección IP54
 Portalámparas E-27 cerámico

| REFERENCIA | COLOR |
|-------------------|--------|
| ILEX.81910 | BLANCO |
| ILEX.81911 | NEGRO |

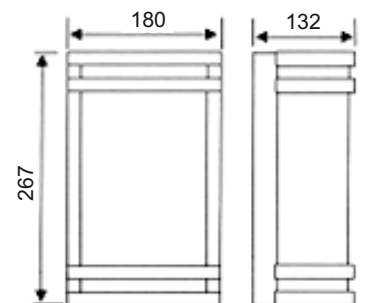

VILALTA, les presenta la última selección de productos de Iluminación **LED**.

90% menos de consumo

La iluminación **LED** consume hasta un 90% menos de electricidad que una bombilla Incandescente.

Ecológicas

No conen en tungsteno como las bombillas incandescentes, ni mercurio como los fluorescentes, son reciclables y cumplen con la normav a europea de sustancias contaminantes ROHS. **VILALTA**, además esta adherida al S.I.G. ECOEMBRES.

No emiten calor

A diferencia de las bombillas incandescentes, la tecnología **LED** no emite calor, lo cual permite instalar luz en sios difíciles, con poco espacio o enemigos del calor, ademas de ahorrar en el consumo del aire acondicionado.

Larga vida

La vida media útil de las lámparas **LEDs VILALTA**, es de 20.000 horas, en cambio la vida de las bombillas incandescentes es de solo 1.000 horas.

Sin mantenimiento

Al tener una larga vida, las lámparas **LEDs VILALTA** no necesitan ningún mantenimiento.

Calidad

VILALTA garan za la calidad de todos sus productos, mediante los Cer ficados correspondientes.

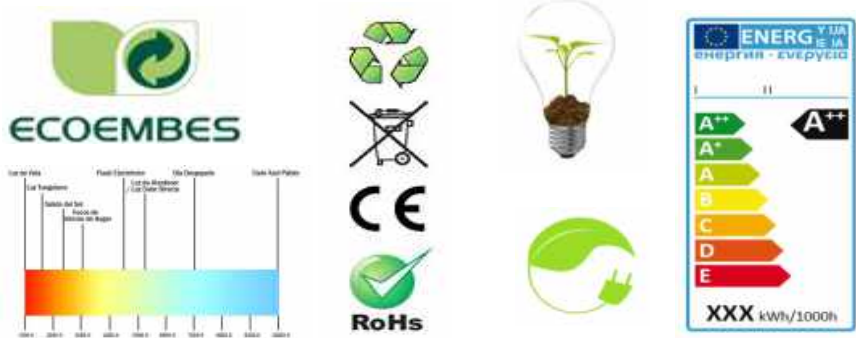
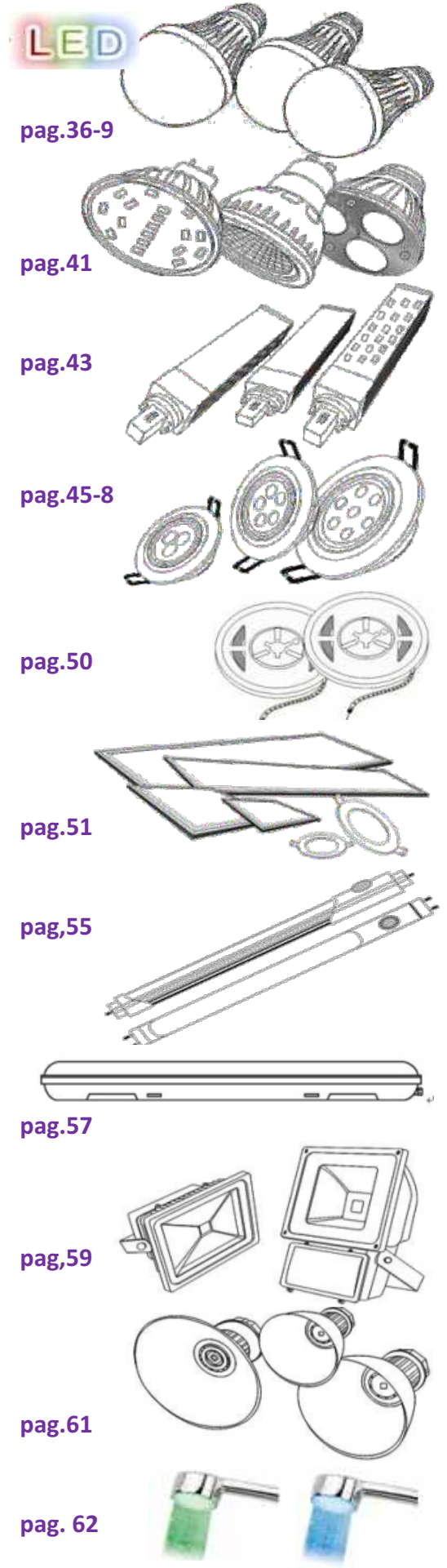

Debido al constante cambio en los **LEDs**, recomendamos visiten nuestra web. [www,vilalta.es](http://www.vilalta.es)

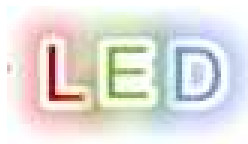

LAMPARAS LED CUERPO CERAMICO, DIFUSOR CRISTAL

Lampara estándar CERAMICA

Casquillo E-27 230V porcelana/ cristal
Supone un ahorro de energia hasta el 90%



| Referencia | Potencia | Lumenes |
|------------------|----------|---------|
| BLEDST10M | 10W | 1000 |



Luz
neutra 4000K

Medidas
55 x 110

Casquillo E-27 230V porcelana/ cristal
Supone un ahorro de energia hasta el 90%

| Referencia | Potencia | Lumenes |
|-------------------|----------|---------|
| BLEDST5M 4 | 5W | 500 |



Luz
neutra 4000K

Medidas
55 x 110

Lampara esferica E-27 ceramica

Casquillo E-27 230V porcelana/ cristal
Supone un ahorro de energia hasta el 90%



| Referencia | Potencia | Lumenes |
|--------------------|----------|---------|
| BLEDES5NM 3 | 5W | 500 |
| BLEDES5NM 6 | 5W | 500 |



Luz
calida 3000K
fria 6500K

Medidas
45 x 85
46 x 85

Lampara esferica E-14 ceramica

Casquillo E-14 230V porcelana/ cristal
Supone un ahorro de energia hasta el 90%



| Referencia | Potencia | Lumenes |
|--------------------|----------|---------|
| BLEDES5MM 3 | 5W | 500 |
| BLEDES5MM | 5W | 500 |
| BLEDES5MM 6 | 5W | 500 |



Luz
calida 3000K
neutra 4000K
fria 6500K

Medidas
45 x 85
45 x 85
45 x 85

Lampara vela ceramica

Casquillo E-14 230V porcelana/ cristal
Supone un ahorro de energia hasta el 90%



| Referencia | Potencia | Lumenes |
|------------------|----------|---------|
| BLEDV5M 3 | 5W | 500 |
| BLEDV5M | 5W | 500 |
| BLEDV5M 6 | 5W | 500 |



Luz
calida 3000K
neutra 4000K
fria 6500K

Medidas
45 x 85
45 x 85
45 x 85



Lampara Reflectora R-50

Casquillo E-14 230V Ceramica / Cristal
Supone un ahorro de energia hasta el 90%

| Referencia | Potencia | Lumenes | Luz | Medidas |
|----------------|----------|---------|--------------|---------|
| BLEDR50 | 5w | 500 | neutra 4000K | 50 x 87 |



Lampara Reflectora R-63

Casquillo E-27 230V Ceramica / cristal
Supone un ahorro de energia hasta el 90%

| Referencia | Potencia | Lumenes | Luz | Medidas |
|----------------|----------|---------|--------------|----------|
| BLEDR63 | 10 w | 1000 | neutra 4000K | 63 x 103 |



Lampara Reflectora R-80

Casquillo E-27 230V Aluminio / cristal
Supone un ahorro de energia hasta el 90%

| Referencia | Potencia | Lumenes | Luz | Medidas |
|----------------|----------|---------|--------------|----------|
| BLEDR80 | 10 W | 1000 | neutra 4000K | 80 x 110 |



Lampara Corn

Casquillo E-27 230V Termoplas ca
Supone un ahorro de energia hasta el 90%

| Referencia | Potencia | Lumenes | Luz | Medidas |
|---------------|----------|---------|--------------|----------|
| BLEDC6 | 6w | 600 | neutra 4000K | 30 X 105 |



Lampara Corn

Casquillo E-27 230V Termoplas ca
Supone un ahorro de energia hasta el 90%

| Referencia | Potencia | Lumenes | Luz | Medidas |
|------------------|----------|---------|--------------|----------|
| BLEDC10 3 | 10 w | 1000 | calida 3000K | 45 X 120 |
| BLEDC10 | 10 w | 1000 | neutra 4000K | 45 X 120 |
| BLEDC10 6 | 10 w | 1000 | fria 6500K | 45 X 120 |
| BLEDC12 3 | 12 w | 1200 | calida 3000K | 48 x 110 |
| BLEDC12 6 | 12 w | 1200 | fria 6500K | 48 x 110 |



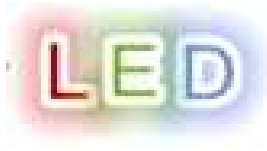

LAMPARAS LED DIFUSOR CRISTAL

Lampara standard



Casquillo E-27 230V porcelana/ cristal
Supone un ahorro de energia hasta el 90%

Referencia
BLE DST6

Potencia
4,5W

Lumenes
390



Luz
calida 3000K

Medidas
55 x 110

Lampara esferica



Casquillo E-27 230V porcelana/ cristal
Supone un ahorro de energia hasta el 90%

Referencia
BLEDES2N

Potencia
2,2W

Lumenes
220



Luz
calida 3000K

Medidas
45 x 75

Lampara esferica



Casquillo E-14 230V porcelana/ cristal
Supone un ahorro de energia hasta el 90%

Referencia
BLEDES2M

Potencia
2,2W

Lumenes
220



Luz
calida 3000K

Medidas
45 x 75

Lampara vela



Casquillo E-14 230V porcelana/ cristal
Supone un ahorro de energia hasta el 90%

Referencia
BLE DV4

Potencia
4W

Lumenes
350



Luz
calida 3000K

Medidas
39 x 112

LAMPARAS LEDs

MATERIAL TERMOPLASTICO PC



Lampara estándar PoliCarbonato PC

Casquillo E-27 230V PC

Supone un ahorro de energia hasta el 90%

| Referencia | Potencia | Lumenes | Luz  | Medidas |
|---------------------|----------|---------|---|---------|
| BLE DST5M 3 | 5W | 500 | calida 3000K | 61x103 |
| BLE DST5M 6 | 5W | 500 | fria 6500K | 61x103 |
| BLE DST9M 3 | 10W | 1000 | calida 3000K | 65x113 |
| BLE DST9M 6 | 10W | 1000 | fria 6500K | 65x113 |
| BLE DST15M 3 | 15W | 1500 | calida 3000K | 75x130 |
| BLE DST15M 6 | 15W | 1500 | fria 6500K | 75x130 |



Lampara esferica E-27 PoliCarbonato PC

Casquillo E-27 230V PC

Supone un ahorro de energia hasta el 90%

| Referencia | Potencia | Lumenes | Luz  | Medidas |
|--------------------|----------|---------|--|---------|
| BLEDES4NM 3 | 4W | 400 | calida 3000K | 45X82 |
| BLEDES4NM 6 | 4W | 400 | fria 6500K | 45X82 |
| BLEDES6NM 3 | 6W | 600 | calida 3000K | 45X82 |
| BLEDES6NM 6 | 6W | 600 | fria 6500K | 45X82 |



Lampara esferica E-14 PoliCarbonato PC

Casquillo E-14 230V PC

Supone un ahorro de energia hasta el 90%

| Referencia | Potencia | Lumenes | Luz  | Medidas |
|--------------------|----------|---------|---|---------|
| BLEDES4MM 3 | 4W | 400 | calida 3000K | 45X82 |
| BLEDES4MM 6 | 4W | 400 | fria 6500K | 45X82 |
| BLEDES6MM 3 | 6W | 600 | calida 3000K | 45X82 |
| BLEDES6MM 6 | 6W | 600 | fria 6500K | 45X82 |



Lampara vela E14 PoliCarbonato PC

Casquillo E-14 230V PC

Supone un ahorro de energia hasta el 90%

| Referencia | Potencia | Lumenes | Luz  | Medidas |
|-------------------|----------|---------|---|---------|
| BLE DV4M 3 | 4W | 400 | calida 3000K | 37X104 |
| BLE DV4M 6 | 4W | 400 | fria 6500K | 37X104 |
| BLE DV6M 3 | 6W | 600 | calida 3000K | 37X104 |
| BLE DV6M 6 | 6W | 600 | fria 6500K | 37X104 |





Lámpara estándar PC Color

Supone un ahorro de energía hasta el 90%

| Referencia | Potencia | Lúmenes | Luz | Medidas | Casquillo |
|-----------------|----------|---------|-----------------|---------|-----------|
| BLEDST5A | 5W | 280 | Amarilla | 55x105 | E -27 |
| BLEDST5R | 5W | 280 | Roja | 55x105 | E -27 |
| BLEDST5V | 5W | 280 | Verde | 55x105 | E -27 |
| BLEDST5Z | 5W | 280 | Azul | 55x105 | E -27 |

Lámpara G-9

Casquillo G-9 230V porcelana/ cristal
Supone un ahorro de energía hasta el 90%

| Referencia | Potencia | Lúmenes | Luz | Medidas | Casquillo |
|-----------------|----------|---------|--------------|---------|-----------|
| BG9LED34 | 3W | 280 | neutra 4000K | 50 x 52 | G9 |

| Referencia | Potencia | Lúmenes | Luz | Medidas | Casquillo |
|------------------|----------|---------|---------------------|-----------|-----------|
| BG9LED5 3 | 5W | 530 | calida 3000K | 14,5 x 60 | G9 |
| BG9LED5 6 | 5W | 540 | fria 6500k | 14,5 x 60 | G9 |
| SILICONA | | | | | |

Lámpara BI-PIN 12V

| Referencia | Potencia | Lúmenes | Luz | Medidas | Casquillo |
|----------------|----------|---------|---------------------|---------|-----------|
| BPIN3 3 | 12V 3 W | 280 | calida 3000K | 15 x 43 | G4 |
| BPIN3 6 | 12V 3 W | 280 | fria 6500k | 15 x 43 | G4 |

Lámpara Tubular

BOMB.LED FRIGORIFICO T20
E-14 cuerpo de silicona
Supone un ahorro de energía hasta el 90%

| Referencia | Potencia | Lúmenes | Luz | Medidas | Casquillo |
|-----------------|----------|---------|-------------------|---------|-----------|
| BTULED56 | 5W | 180 | fria 6500k | 16 x 65 | E 14 |

GU10 ALUMINIO



| REFERENCIA | POTENCIA | LUMENS | LUZ | CASQUILLO | EQUIPO | Medidas |
|--------------------|----------|--------|---------------|-----------|--------|---------|
| BGU10 LED13 | 1x3w=3w | 150 | neutra 4000°K | GU10 | 230v | 50 x 58 |



GU10 ALUMINIO



| REFERENCIA | POTENCIA | LUMENS | LUZ | CASQUILLO | EQUIPO | Medidas |
|--------------------|----------|--------|---------------|-----------|--------|---------|
| BGU10 LED31 | 3x1w=3w | 150 | neutra 4000°K | GU10 | 230v | 50 x 58 |
| BGU10 LED32 | 3x1w=3w | 210 | calida 3000K | GU10 | 230v | 50 x 58 |
| BGU10 LED36 | 3x1w=3w | 210 | fria 6500°K | GU10 | 230v | 50 x 58 |



GU10 ALUMINIO



| REFERENCIA | POTENCIA | LUMENS | LUZ | CASQUILLO | EQUIPO | Medidas |
|--------------------|----------|--------|--------------|-----------|--------|---------|
| BGU10 LED52 | 5x1w=5w | 250 | calida 3000K | GU10 | 230v | 50 x 58 |
| BGU10 LED56 | 5x1w=5w | 250 | fria 6500°K | GU10 | 230v | 50 x 58 |



GU10 SMD ALUMINIO



| REFERENCIA | POTENCIA | LUMENS | LUZ | CASQUILLO | EQUIPO | Medidas |
|--------------------|----------|--------|---------------|-----------|--------|---------|
| BGU10 SMD52 | 5w | 350 | calida 3000°K | GU10 | 230v | 50 x 58 |
| BGU10 SMD56 | 5w | 350 | fria 6500°K | GU10 | 230v | 50 x 58 |



GU10 SMD ALUMINIO BLANCO

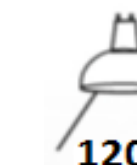

| REFERENCIA | POTENCIA | LUMENS | LUZ | CASQUILLO | EQUIPO | Medidas |
|--------------------|----------|--------|---------------|-----------|--------|---------|
| BGU10 LED72 | 7 w | 500 | calida 3000°K | GU10 | 230v | 50 x 58 |
| BGU10 LED76 | 7 w | 500 | fria 6500°K | GU10 | 230v | 50 x 58 |





LAMPARAS LED DICROICAS MR16 ø 50 mm

MR16 Cristal

12 V



| REFERENCIA | POTENCIA | LUMENS | LUZ | CASQUILLO | EQUIPO | Medidas |
|--------------------|-----------|--------|-------------|-----------|--------|---------|
| BMR16 LED | 12v-1,5w | 100 | fria 6500°K | G5,3 | ILDR 3 | 50 x 52 |
| BMR16220LED | 230v-1,8w | 100 | fria 6500°K | G5,3 | 230v | 50 x 52 |

MR16 Aluminio

12 V



| REFERENCIA | POTENCIA | LUMENS | LUZ | CASQUILLO | EQUIPO | Medidas |
|--------------------|----------|--------|--------------|-----------|--------|---------|
| BMR16 LED13 | 1x3w | 150 | 4000°K | G5,3 | ILDR 3 | 50 x 52 |
| BMR16 LED32 | 3x1w=3w | 210 | calida 3000K | G5,3 | ILDR 3 | 50 x 52 |
| BMR16 LED36 | 3x1w=3w | 210 | fria 6500°K | G5,3 | ILDR 3 | 50 x 52 |

MR16 Aluminio Blanco

12 V



| REFERENCIA | POTENCIA | LUMENS | LUZ | CASQUILLO | EQUIPO | Medidas |
|--------------------|----------|--------|--------------|-----------|--------|---------|
| BMR16 LED72 | 7 w | 500 | calida 3000K | G5,3 | ILDR 7 | 50 x 52 |
| BMR16 LED76 | 7 w | 500 | fria 6500°K | G5,3 | ILDR7 | 50 x 52 |

EQUIPOS DE ENCENDIDO-DRIVERS

PARA BOMBILLAS 12 V



- ILDR.3** Valido para bombilla 110-265V 50/60Hz salida 12V 3 W
- ILDR.4** Valido para bombilla 110-265V 50/60Hz salida 12V 4 - 5W
- ILDR.7** Valido para bombilla 110-265V 50/60Hz salida 12V 7 W

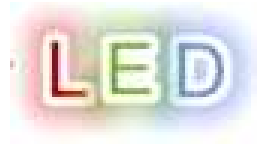

Lampara AR-111

Casquillo G-53 12V Aluminio
Supone un ahorro de energia hasta el 90%



| Referencia | Potencia | Lumenes | Luz | Medidas | Casquillo |
|------------------|----------|---------|------------|----------|-----------|
| BAR111-24 | 12V 12W | 960 | fria 6500K | 58 x 111 | G53 |

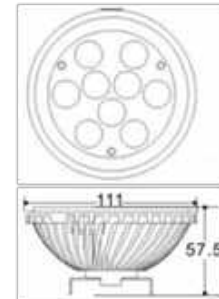

Bombilla LED para Downlight

. Directo a 220V
Casquillo G24d3 220V Aluminio
Supone un ahorro de energia hasta el 90%
ROTACION 90°



| Referencia | Potencia | Lumenes | Luz | Medidas | Casquillo |
|--------------------|----------|---------|--------------|----------|-----------|
| BPLC26 4LED | 11 W | 1000 Lm | neutra 4000K | 35 x 162 | G24d3 |



. Directo a 220V
Casquillo E-27 220V Aluminio
Supone un ahorro de energia hasta el 90%
ROTACION 90°



| Referencia | Potencia | Lumenes | Luz | Medidas | Casquillo |
|--------------------|----------|---------|--------------|----------|-----------|
| BPLN26 4LED | 11 W | 1000 Lm | neutra 4000K | 35 x 162 | E-27 |

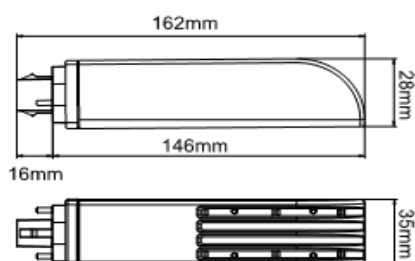



LED LINEAL 118 mm R7s



- . Sustituyen a halógenas lineales de 118mm
- . Duración 50.000 horas
- . Directa a 220V
- . Leds de alta luminosidad



| Referencia | Potencia | Lumenes | Luz | Medidas | Casquillo |
|-------------------|----------|---------|--------------|----------|-----------|
| BLED.EX8 4 | 8W | 720 | neutra 4000k | 36 x 118 | R7s |
| BLED.EX8 6 | 8W | 720 | | 36 x 118 | R7s |

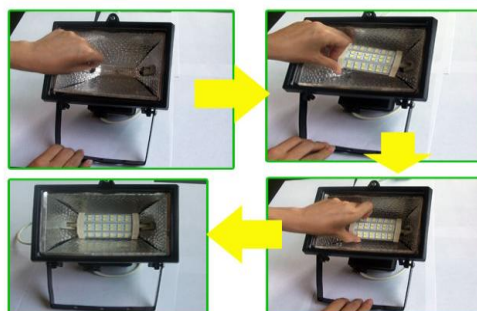

LED LINEAL DE 78 Y 118 mm R7s

- . Sustituyen a halógenas lineales de 78 y 118mm
- . Duración 50.000 horas
- . Directa a 220V
- . Leds de alta luminosidad



| Referencia | Potencia | Lumenes | Luz | Medidas | Casquillo |
|--------------------|----------|---------|-----|----------|-----------|
| BLED.EX5 3 | 5 W | 450 | | 29 x 78 | R7s |
| BLED.EX5 6 | 5 W | 450 | | 29 x 78 | R7s |
| BLED.EX10 3 | 10W | 950 | | 29 x 118 | R7s |
| BLED.EX10 6 | 10W | 950 | | 29 x 118 | R7s |

LED LINEAL 118 mm R7s

- . Sustituyen a halógenas lineales de 118mm
- . Duración 20.000 horas
- . Directa a 220V



| Referencia | Potencia | Lumenes | Luz | Medidas | Casquillo |
|------------------|----------|---------|--------------|----------|-----------|
| BLED.EX 6 | 6W | 360 | neutra 4000K | 36 x 118 | R7s |

FOCO BASCULANTE



| Referencia | Potencia | Lumenes | Luz | Medidas | Equipo |
|------------------|----------|---------|--------------|-------------|---------|
| FOLED.30B | 30W | 2500 | neutra 4000k | 240x150x137 | ILDR 31 |



FOCO FIJO NIQUEL MATE



| Referencia | Potencia | Lumenes | Luz | Medidas | Equipo |
|------------------|----------|---------|--------------|---------|--------|
| FOLED.3NM | 3w | 280 | neutra 4000k | 80 x 20 | ILDR 4 |



| Referencia | Potencia | Lumenes | Luz | Medidas | Equipo |
|------------------|----------|---------|--------------|---------|--------|
| FOLED.4CM | 4w | 350 | neutra 4000k | 85 x 80 | ILDR |

BASCULANTE



BOMBILLA LEDS GX 53

REGULABLES

| Referencia | Potencia | Lumenes | Luz | Medidas | Equipo |
|------------------|----------|---------|--------------|---------|--------|
| BGX53 L3B | 4,5w | 260 | neutra 4000K | 74 X 25 | 230v |
| BGX53 L1B | 1,5w | 130 | fria 6500K | 74 X 25 | 230v |



- FOGX53. C** Aro de empotrar cromo sin bombilla
- FOGX53. G** Aro de superficie PVC gris sin bombilla
- FOGX53.GK** Aro de superficie PVC gris con bombilla de 7W

PRESENTADOS EN CAJAS INDIVIDUALES CON PORTALAMPARAS G5,3 "MEVI.4081"

CHAPA FIJO



| REFERENCIA | COLOR | MEDIDAS |
|----------------|------------|---------|
| FOFI B | Blanco | 80 X 35 |
| FOFI CM | Cromo Mate | 80 X 35 |
| FOFI O | Oro | 80 X 35 |

CHAPA GIRATORIO



| REFERENCIA | COLOR | MEDIDAS |
|----------------|------------|----------|
| FOGI B | Blanco | 100 x 46 |
| FOGI CM | Cromo Mate | 100 x 46 |
| FOGI O | Oro | 100 x 46 |

CHAPA BASCULANTE



| REFERENCIA | COLOR | MEDIDAS |
|----------------|------------|---------|
| FOBA B | Blanco | 96 x 30 |
| FOBA CM | Cromo Mate | 96 x 30 |
| FOBA O | Oro | 96 x 30 |

AROS DE EMPOTRAR DE CRISTAL DICROICAS ø 50mm

medidas 105 x 70



FOFI C Z
Azul



FOFI C B
Blanco



FOFI C V
Verde



FOFI C RS
Rosa

PRESENTADOS EN CAJAS INDIVIDUALES CON PORTALAMPARAS G5,3

ZAMAK FIJO

| REFERENCIA | COLOR | MEDIDAS |
|------------------|------------|---------|
| FOFI B Z | BLANCO | 80 x 20 |
| FOFI CM Z | CROMO MATE | 80 x 20 |
| FOFI O Z | ORO | 80 x 20 |



ZAMAK BASCULANTE

| REFERENCIA | COLOR | MEDIDAS |
|------------------|------------|---------|
| FOBA B Z | BLANCO | 83 x 20 |
| FOBA CM Z | CROMO MATE | 83 x 20 |
| FOBA O Z | ORO | 83 x 20 |



ZAMAK CUADRADO

| REFERENCIA | COLOR | MEDIDAS |
|----------------|------------|---------|
| FOCU CM | CROMO MATE | 84 x 84 |



ZAMAK CUADRADO

| REFERENCIA | COLOR | MEDIDAS |
|------------------|------------|-----------|
| FOCU B | BLANCO | 100 x 100 |
| FOCU B CM | CROMO MATE | 100 x 100 |



LED

AROS DE EMPOTRAR DICROICAS Ø 50mm

PRESENTADOS EN CAJAS INDIVIDUALES CON PORTALAMPARAS G5,3



SE PUEDEN ESCOGER EN CAJA " KIT " COMPUESTA DE:



- . Aro a elegir
- . Portalámparas GX5,3 o GU10
- . Bombilla dicroica MR16
- . Bombilla GU10
- . Transformador / driver
Electrónico o Magnético a elegir

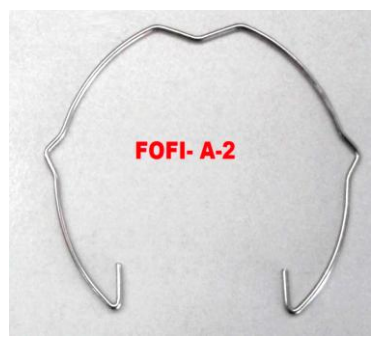

MEVI.4080 GU/GZ-10



MEVI.4081 G5,3



MEVI.4106 R7s

EQUIPOS DE ENCENDIDO-DRIVERS



PARA BOMBILLAS 12V

- TR1250E** Transformador Electronico 220V/12V- 50W
- TR1260** Transformador Electronico 220V/12V- 60W
- TR12105** Transformador Electronico 220V/12V- 105W
- TR12150** Transformador Electronico 220V/12V- 150W



ELECTRONICOS PARA LEDS

- TR 33** Tranformador para Led 12V - 3W - 650mA
- TR 123** Transformador para Led 3,6V - 3W - 950mA
- TR 24 10** Transformador para Led 24V - 10W - 350mA



MAGNETICO

- TR1220** Transfo-Reactancia 220V/12V-20W
- TR1250** Transfo-Reactancia 220V/12V-50W



- ILDR.3** Valido para bombilla MR16 12V 3x1W y 1x3W.
- ILDR.4** Valido para bombilla MR16 salida 12V 4-5x1W
- ILDR.7** Valido para bombilla MR16 salida 12V 5-7x1W



PARA DOWLIGHTS



- ILDR.18 H** Drivers Hembra 18W AC.85-265V 50/60Hz salida DC.45-57V 280mA
- ILDR.18 M** Drivers Macho 18W AC.85-265V 50/60Hz salida DC.45-57V 280mA
- ILDR.24** Drivers 24W AC.85-265V 50/60Hz salida DC78-84V 300mA
- ILDR.40** Drivers plafon cuadrado 40W AC 85-265 50/60Hz DC 36-42V 880mA
- ILDR.31** Drivers 30W AC.85-265V 50/60Hz salida DC26-36V 1A



PARA FOCOS DE EXTERIOR

- ILDR.10** Diver 10W AC 100.265V DC 0,2A 200mA 0,75W
- ILDR.20** Driver 20W AC 175-240V 50/60Hz DC.27-42V 900mA
- ILDR.30** Driver 30W AC 175-240V 50/60Hz DC.27-42V 900mA
- ILDR.50** Driver 50W AC 175-240V 50/60Hz DC27-42V 1500mA



. Todas nuestras tiras llevan soldado el conector H. DC 5,5mm para el alimentador

- . Recortables y flexibles
- . Conectores inyectados (no soldados)



- . Adhesivo alta calidad 3M
- . Lumens por metro 810 lm
- . Protección IP33 (interior)



| Referencia | Longitud | Color | NºLeds x metro | Tipo Led | Alimentador | Waos x metro |
|------------|----------|----------------|----------------|----------|-------------|--------------|
| ILED.60C | 5 metros | Blanco Cálido | 60 | SMD 3528 | ILED.36 | 4,8 |
| ILED.60D | 5 metros | Blanco Frío | 60 | SMD 3528 | ILED.36 | 4,8 |
| ILED.60A | 5 metros | Amarillo | 60 | SMD 3528 | ILED.36 | 4,8 |
| ILED.60R | 5 metros | Rojo | 60 | SMD 3528 | ILED.36 | 4,8 |
| ILED.60V | 5 metros | Verde | 60 | SMD 3528 | ILED.36 | 4,8 |
| ILED.60Z | 5 metros | Azul | 60 | SMD 3528 | ILED.36 | 4,8 |
| ILED.601C | 1 metro | Blanco Cálido | 60 | SMD 3528 | ILED.12 | 4,8 |
| ILED.601D | 1 metro | Blanco Frío | 60 | SMD 3528 | ILED.12 | 4,8 |
| ILED.120C | 5 metros | Blanco Cálido | 120 | SMD 3528 | ILED.60 | 9,6 |
| ILED.120D | 5 metros | Blanco Frío | 120 | SMD 3528 | ILED.60 | 9,6 |
| ILED.30RGB | 5 metros | RGB-Multicolor | 30 | SMD 5050 | ILED.36 | 7,2 |

Alimentadores conector M. DC 2,1mm



ILED.12 - 12W-1A



ILED.36 - 36W-3A



ILED.60 - 60W-5A



ILED.100 - 100W-8,3A

ACCESORIOS PARA TIRAS MONOCOLOR



Conector a r a
ILED.60-COR

20 cm



Conexión flexible de ta Led al alimentador
ILED.60-CORD



Unión flexible
ILED.60-COC



ACCESORIOS PARA TIRAS RGB - MULTICOLOR



Controlador y
mando RGB
Mulcolor
ILED.30RGB-C

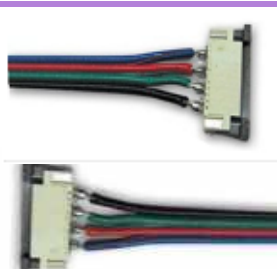

Unión flexible
RGB-Mul color
ILED.RGB-COC

20 cm



de r a controlador
ILED.RGB-COR

FOLE.36/4 CM - Marco Cromo Mate - Cristal Mate

- . Potencia 36w
- . Voltaje: DC-24V 50/60Hz
- . Luminosidad: 1850 Lm
- . Extraplano. Medidas: 298mm x 298mm
- . Altura: 12,6mm
- . Vida: 25.000 horas
- . Incluye Kit accesorios para colgar
- . Mando a distancia con múltiples funciones (regulador intensidad, memorias, apagado)
- . Color: 4200°K
- . IP54



FOLE.36/4 M - Marco Embellecedor para instalación en superficie

PANEL LED 60 x 60 TECHO ARMSTRONG

- . Potencia 40w
- . Voltaje: 100/240 50/60Hz
- . Luminosidad: 3672 Lm
- . Extraplano. Medidas: 600mm x 600mm
- . Altura: 11,5mm
- . Vida: 25.000 horas

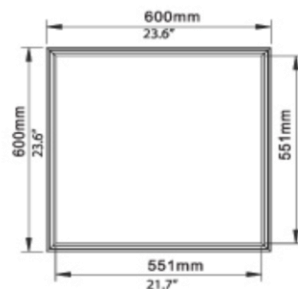

| Referencia | Potencia | Lumenes | Luz | Medidas | Marco | Equipo |
|-------------------|----------|---------|-------------------|---------|--------|--------|
| FOLE60 4 B | 40W | 3670 | neutra 4000K | 60x60 | blanco | ILD40 |
| FOLE60 4 | 40W | 3670 | neutra 4000K | 60x60 | Cromo | ILD40 |
| FOLE60 6 | 40W | 3670 | fria 6500K | 60x60 | Cromo | ILD40 |



DOWNLIGHT LED EMPOTRABLE EXTRAPLANO



| Referencia | Potencia | Lumenes | Luz | Medidas | Aro | Equipo |
|--------------------|----------|---------|--------------|---------|--------|---------|
| FOLE12 4 B | 12W | 1100 | neutra 4000K | Ø170x24 | Blanco | ILDR.12 |
| FOLE12 6 B | 12W | 1200 | fria 6500K | Ø170x24 | Blanco | ILDR.12 |
| FOLE18 4 CM | 18W | 1540 | neutra 4000K | Ø220x24 | Cromo | ILDR.18 |
| FOLE18 4 B | 18W | 1540 | neutra 4000K | Ø220x24 | Blanco | ILDR.18 |
| FOLE18 6 B | 18W | 1620 | fria 6500K | Ø220x24 | Blanco | ILDR.18 |
| FOLE24 4 B | 24W | 2280 | neutra 4000K | Ø300x24 | Blanco | ILDR.24 |
| FOLE24 6 B | 24W | 2400 | fria 6500K | Ø300x24 | Blanco | ILDR.24 |

DOWNLIGHT LED SUPERFICIE



| Referencia | Potencia | Lumenes | Luz | Medidas | Aro | Equipo |
|--------------------|----------|---------|--------------|---------|--------|--------|
| FOLE18 4 SB | 18W | 1540 | neutra 4000K | Ø220x24 | Blanco | TR-18 |
| FOLE18 6 SB | 18W | 1620 | fria 6500K | Ø220x24 | Blanco | TR-18 |

DOWNLIGHT LED EMPOTRABLE CUADRADO



| Referencia | Potencia | Lumenes | Luz | Medidas | Aro | Equipo |
|-------------------|----------|---------|---------------|---------|--------|--------|
| FOLE18 4CB | 18W | 1100 | neutra 4000K | Ø230x24 | Blanco | TR-18M |
| FOLE18 6CB | 18W | 1200 | Luz dia 6500K | Ø230x24 | Blanco | TR-18M |

DOWNLIGHT LED SUPERFICIE CUADRADO



| Referencia | Potencia | Lumenes | Luz | Medidas | Aro | Equipo |
|--------------------|----------|---------|--------------|---------|--------|--------|
| FOLE18 4CSB | 18W | 1100 | neutra 4000K | Ø220x40 | Blanco | TR-18M |
| FOLE18 6CSB | 18W | 1100 | fria 6500K | Ø220x40 | Blanco | TR-18M |

Tubo de LED T8 cuerpo de aluminio



Tubo T8 de LEDs SMD5630 de alta luminosidad translúcido.
Funciona sin transformadores ni cebadores, directo a 220V
Garantía 2 años



| Referencia | Potencia | Lúmenes | LEDs | Luz LED | medidas |
|------------------|----------|---------|------|-------------------|----------|
| TF10LED 4 | 10W | 700Lm | 48 | neutra 4000K | Ø26x600 |
| TF10LED 6 | 10W | 880Lm | 48 | fría 6500K | Ø26x600 |
| TF20LED 4 | 20W | 1400Lm | 96 | neutra 4000K | Ø26x1200 |
| TF20LED 6 | 20W | 1760Lm | 96 | fría 6500K | Ø26x1200 |
| TF25LED 4 | 25W | 1700Lm | 120 | neutra 4000K | Ø26x1500 |
| TF25LED 6 | 25W | 1880Lm | 120 | fría 6500K | Ø26x1500 |

Tubo de LED T8 Cristal

Tubo T8 de LEDs SMD5630 de alta luminosidad translúcido.
Funciona sin transformadores ni cebadores, directo a 220V
Garantía 2 años

contactos rotativos



| Referencia | Potencia | Lúmenes | LEDs | Luz LED | medidas |
|--------------------|----------|---------|------|-------------------|----------|
| TF10LED 4 C | 10W | 700Lm | 48 | neutra 4000K | Ø26x600 |
| TF10LED 6 C | 10W | 880Lm | 48 | fría 6500K | Ø26x600 |
| TF20LED 4 C | 20W | 1400Lm | 96 | neutra 4000K | Ø26x1200 |
| TF20LED 6 C | 20W | 1760Lm | 96 | fría 6500K | Ø26x1200 |
| TF25LED 4 C | 25W | 1700Lm | 120 | neutra 4000K | Ø26x1500 |
| TF25LED 6 C | 25W | 1880Lm | 120 | fría 6500K | Ø26x1500 |

Tubo de LED T8 Cristal

Tubo T8 de LEDs SMD5630 de alta luminosidad translúcido.
Funciona sin transformadores ni cebadores, directo a 220V
Garantía 2 años

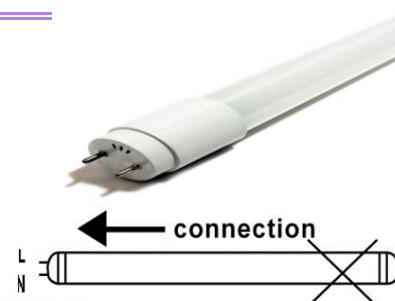

| Referencia | Potencia | Lúmenes | LEDs | Luz LED | medidas |
|---------------------|----------|---------|------|-------------------|----------|
| TF10LED 6 C1 | 10W | 880Lm | 48 | fría 6500K | Ø26x600 |
| TF20LED 6 C1 | 20W | 1760Lm | 96 | fría 6500K | Ø26x1200 |
| TF25LED 6 C1 | 25W | 1880Lm | 120 | fría 6500K | Ø26x1500 |

Tubo de LED T8 CON SENSOR carcasa aluminio

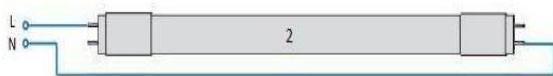

conexionado

Tubos led con detector de movimientos para un ahorro máximo.

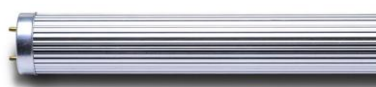

Incluyen sensor radar que al detectar movimiento en su amplio radio de detección, ofrece el máximo de luminosidad, y cuando no detecta movimiento reduce al 10% su intensidad con un consumo mínimo, ofreciendo una luz de cortesía muy superior a las soluciones convencionales. Máxima eficiencia que ofrece un ahorro energético de más del 60% respecto a los tubos fluorescentes convencionales. Otra gran ventaja es el ahorro en mantenimiento ya que el tubo LED no necesita ni reactancias ni cebadores. Además duran hasta 10 veces más que un tubo convencional tiene una vida útil aproximada de 8000 horas, frente al tubo LED de 50000 horas. Tienen encendido inmediato y no contaminan el medio ambiente al no tener mercurio

| Referencia | Potencia | Lúmenes | LEDs | Luz | medidas |
|-------------------|----------|---------|------|------------|----------|
| TF10LED 6S | 9W | 700Lm | 48 | fría 6500K | Ø26x600 |
| TF20LED 6S | 18W | 1400Lm | 90 | fría 6500K | Ø26x1200 |

mevi.4067 Porta fluorescentes Leds con 2 metros de cable



mevi.446 2 Polos Soporte para fluorescentes T-8



Tubo de LED CIRCULAR T-9 G10q



| Referencia | Potencia | Lúmenes | Luz | medidas |
|------------------|----------|---------|------------|----------|
| TC12LED 6 | 12W | 1450Lm | fría 6500K | Ø22,5x30 |
| TC18LED 6 | 18W | 2100Lm | fría 6500K | Ø30x30 |

mevi.4084 Portafluorescente circular G10q





| REFERENCIA | POTENCIA | LARGO /mm | ALTO /mm | ANCHO /mm |
|--------------------|----------------|-----------|----------|-----------|
| ILIN41118 V | 1 x 18W | 65,0 | 47,0 | 80,0 |
| ILIN41136 V | 1 x 36W | 125,0 | 47,0 | 80,0 |
| ILIN41158 V | 1 x 58W | 155,0 | 47,0 | 80,0 |

Esta luminaria está fabricada en chapa de acero pintada en epoxi poliéster RAL 9010.



| REFERENCIA | POTENCIA | LARGO /mm | ALTO /mm | ANCHO /mm |
|--------------------|----------------|-----------|----------|-----------|
| ILIN41218 V | 2 X 18W | 65,0 | 101,0 | 82,0 |
| ILIN41236 V | 2 X 36W | 125,0 | 101,0 | 82,0 |
| ILIN41258 V | 2 X 58W | 155,0 | 101,0 | 82,0 |



EXTRA-PLANA



- . Cuerpo aluminio. Puntas plástico.
- . Accesorios fijación incluidos.

| REFERENCIA | POTENCIA | LARGO /mm | ALTO /mm | ANCHO /mm |
|-----------------|----------|-----------|----------|-----------|
| IN.42120 | 20w | 697 | 60 | 50 |
| IN.42140 | 40w | 1308 | 60 | 50 |

EXTRA-PLANA CON DIFUSOR



| REFERENCIA | POTENCIA | LARGO /mm | ALTO /mm | ANCHO /mm |
|-------------------|----------|-----------|----------|-----------|
| IN.45218 V | 20w | 697 | 56 | 162 |
| IN.45236V | 40w | 1308 | 56 | 162 |



* Todas estas luminarias estan conexionadas como la imagen

REGLETA ESTANCA IP65 ELECTRIFICADA PARA TUBOS LED



ESCOJA LA CONEXIÓN:

C



C1

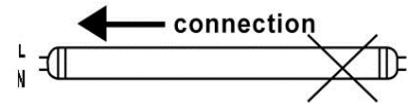

- . Base ABS, Difusor PC (Poli-carbonato)
- . Garras metálicas
- . Sujeción an-caida difusor
- . Totalmente estanca. Protección IP65
- . Electrificada



IN.44001
CLIP METALICO



IN.43117 Accesorio colgador
Para pantallas 1 tubo. Kit 2 piezas



IN.43217 Accesorio colgador
Para pantallas 2 tubos. Kit 2 piezas

| REFERENCIA | Tubos | POTENCIA | L/mm |
|-------------------|-------|----------|------|
| IN.44118 V | 1 | 18W | 600 |
| IN.44136 V | 1 | 36W | 1200 |
| IN.44158 V | 1 | 58W | 1500 |
| IN.44218 V | 2 | 18W | 600 |
| IN.44236 V | 2 | 36W | 1200 |
| IN.44258 V | 2 | 58W | 1500 |

REGLETA ESTANCA IP65 CON LED

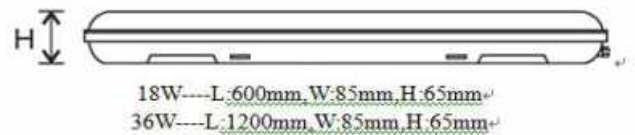

IN.46218

IN.46236

| | | |
|---------------------|-----------------------|----------------|
| Wa age | 2 X 9 = 18W | 2 X 18 = 36W |
| Dimension | 600x85x65 | 1200x85x65 |
| Input Voltage | AC 85V - 265V | |
| LED | 90PCS SMD2835 | 180PCS SMD2835 |
| Lumens flux | 1800 Lm | 3600 Lm |
| color | 4000K | |
| Material | ABS base & PC difusor | |
| Vida | 30.000 h | |
| Temperatura trabajo | -20°C a 45°C | |
| Cajas | 12 Piezas | 12 Piezas |

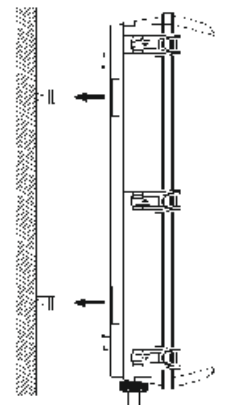

**ILEX.86506**

AC 85~265V

Con 2 chips COB de 50Wattios, 100W - 9600LM
tiene un alcance de 15-20 metros

6500 k

ALUMINIO/CRISTAL

IP-65

50.000 Horas

recambio Drivers ILDR100

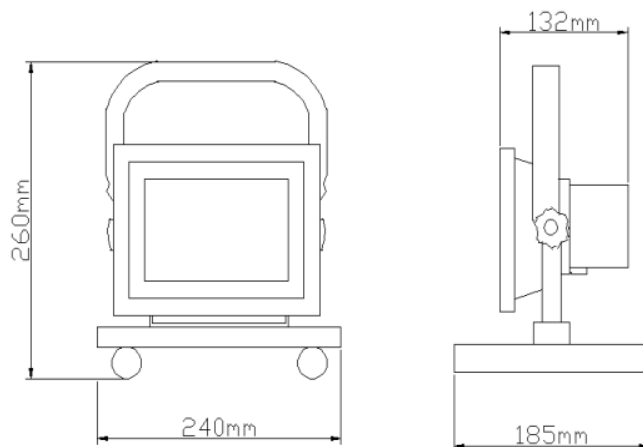
FOCO LEDs PORTATIL 20W**ILEX.86505**

| | | | |
|--------------------------------|--|-------------------------------|---|
| Cargador | salida AC90V-265V:: entrada DC8.4V 2000mA | Cargador de coche: | salida DC12V-24V:: entrada DC8.4V 1000MA |
| Bateria interna: | 8pcs litio 8800mAh bateria 7.4V | Chip : | COB 20W LED (frio) |
| Color temperature : | 6000K~6500K | Potencia: | 20W (±10%) |
| Temperatura de trabajo: | -30°C~+45°C | IP : | IP65 |
| Tiempo Carga | >5h | Ángulo de visión: | 140° |
| Duración Bateria | >3h | Lumenes | 1500 |
| Peso | 2.35KG | Peso | 2.6KG |
| Tamaño : | 19 x 24 x 22 cm | Distancia Luminica | 10 - 15 metros |

ILEX.86152



AC 85~265V
10W - 1000LM
6500 k
ALUMINIO/CRISTAL
IP-65
20.000 Horas recambio
Drivers ILDR10

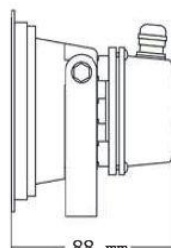
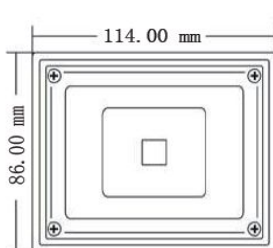

ILEX.86503



AC 85~265V
30W - 3800LM
6500 k
ALUMINIO/CRISTAL
IP-65
20.000 Horas recambio
Drivers ILDR30

MULTILED



ILEX.86102



AC 85~265V
50W - 4500LM
6500 k
ALUMINIO/CRISTAL
IP-65
20.000 Horas recambio
Drivers ILDR50

MULTILED



ILEX.86504



20W SENSOR
AC 85~265V
20W - 2100LM
6500 k
ALUMINIO/CRISTAL
IP-65
20.000 Horas recambio
Drivers ILDR50

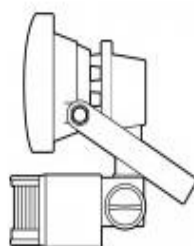

* Drivers de recambio en hoja

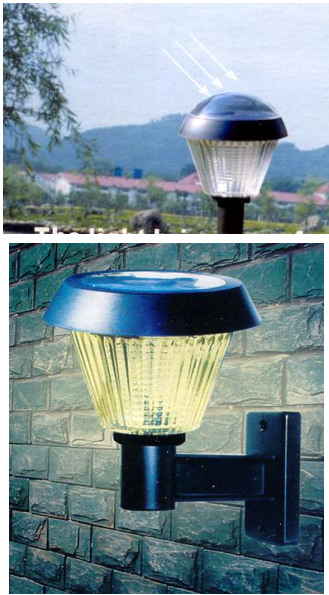

| REFERENCIA | COLOR |
|------------|-------|
| EX - 86700 | NEGRO |

Carga la batería a través del panel solar.
 Material: Poly-Cristaline
 Kit de fijación a pared o suelo (pincho)
 Led de alta luminosidad
 Batería: Pila R6-AA incluida
 No conectable a corriente
 Duración con máxima carga 8 horas
 Interruptor ON/OFF

Con el interruptor en posición ON se activará cuando detecte oscuridad siempre que esté cargado a través del panel solar. Cuando detecte claridad se apagará.



| REFERENCIA | COLOR |
|------------|-------|
| EX - 86670 | NEGRO |

PINCHO JARDIN PARA PAR-38

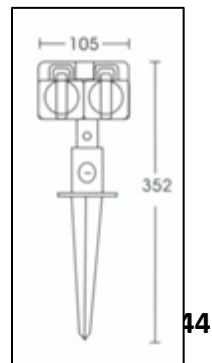

| REFERENCIA | COLOR |
|------------|-------|
| EX - 86672 | NEGRO |

PINCHO JARDIN CON 2 BASES SCHUCO

APLIQUE EMPOTRABLE SOLAR-LED

ILEX.82503



- . Medidas: Ø120x35mm
- . 3 Leds
- . Acero inox.
- . Hasta 8h de uso por carga
- . Batería recargable de Ni-Mh incluida
- . Water Resistant

CAMPANA MULTILED 150W

IIIN.50152



LED de alimentación: 150 W

* Voltaje de entrada: CA 100-265V

* Lúmenes: 16500 lm



* Color : 6500K

* Ángulo de haz: 110 ° Ø 50cm

* CRI: RA > 70

* PF: > 0.90

* LED vida laboral: 25000H

* Grado del IP: IP44

* Temperatura ambiente -40 ° C ~ + 50 ° C

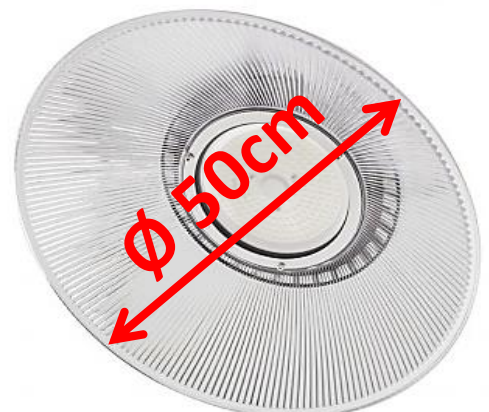



AGLED B

Según la temperatura del agua cambia de color
 No usa pilas, funciona como una dynamo
 Facil instalación, cambiar por la antigua Pala
 No usar herramientas para su apriete solo usar las manos
 conexión M.1/2 "



AGLED D

Según la temperatura del agua cambia de color
 No usa pilas, funciona como una dynamo
 Facil instalación, cambiar por el antiguo Plafon
 No usar herramientas para su apriete solo usar las manos
 conexión H.1/2 "



AGLED G



Según la temperatura del agua cambia de color
 No usa pilas, funciona como una dynamo
 Facil instalación, cambiar por el antiguo filtro
 No usar herramientas para su apriete solo usar las manos
 conexión M.24 mm
 No tiene caducidad, ni mantenimiento



| | Potencia | Lumenes | Color - K | Ø | Largo | MEVI |
|-------------------|----------|---------|--------------|----|-------|-----------|
| BLI 5 1 2 | 5W | 400 | calida 2700K | 30 | 300 | MEVI 4059 |
| BLI 5 2 2 | 5W | 400 | calida 2700K | 30 | 300 | MEVI 4060 |
| BLI 8 1 2 | 8W | 640 | calida 2700K | 30 | 500 | MEVI 4059 |
| BLI 8 2 2 | 8W | 640 | calida 2700K | 30 | 500 | MEVI 4060 |
| BLI 16 2 2 | 16W | 1280 | calida 2700K | 30 | 1000 | MEVI 4060 |

MEVI4059 PORTALINESTRA S14s
MEVI4060 PORTALINESTRA S14d



S14s



S14d

BOMBILLA DISCO DE LED

B DISCO

Voltaje: 3,7W Potencia: AC85 - 260V
 Color de la luz: RGB Ángulo de giro: 360°
 Peso: 100g Diámetro: 6*11.5cm
 Frecuencia: 50/60Hz
 Material: Cubierta de acrílico
 Dimensiones: 14 x 8 x 8 cm



B DISCO P PORTALAMPARAS E-27 CON INTERRUPTOR



Tira LED RGB con protección IP67 y LEDs Epistar SMD5050 con tan sólo 14,4W de consumo por metro. Este tipo de tira LED flexible se conecta directamente a la red eléctrica de 220V AC mediante un cable Alimentador, que soporta hasta un máximo de 20 metros de Tira LED. Para una perfecta protección IP67 es el cliente quien debe asegurar y proteger estas partes. Las tiras LED 220V pueden cortarse cada metro, exclusivamente por la zona habilitada para tal.

| |  |  |  |  |
|-------------------|---|---|--|---|
| | ILED5050RGB | ILED5050R | ILED5050Z | ILED5050D |
| ROLLO | 50 MTS | 50 MTS | 50 MTS | 50 MTS |
| LED TYPE | SMD5050 | SMD5050 | SMD5050 | SMD5050 |
| LEDs/M | 60 | 60 | 60 | 60 |
| Volt. (V) | 220V-230v | 220V-230v | 220V-230v | 220V-230v |
| WATT/M | 14.4W | 14.4W | 14.4W | 14.4W |
| COLOR | RGB | ROJA | AZUL | 6500K Luz día |
| LM/LED | / | 12-14LM | 12-14LM | 12-14LM |
| ANCHO (mm) | 10mm | 8mm | 8mm | 8mm |
| MATERIAL | cobre | cobre | cobre | cobre |

| IP.67 |  | DESCRIPCIÓN | |
|---|---|---|--|
|  | ILED50CRGB | <p>Cable Alimentador 220V AC IP65 Tira LED SMD5050 RGB</p> <p>Alimentador diseñado para tiras led 220V-RGB con el que es posible gestionar los canales RGB de una forma eficaz. Cada alimentador RGB soporta hasta 20 metros lineales de tira LED RGB de 60 led por metro. Con este Alimentador es posible seleccionar el efecto y las transiciones.</p> | |
|  | ILED50CURGB | <p>Cable Conector Tira LED SMD5050 RGB 220V AC</p> | |
|  | ILED50RGB | <p>Controlador Tira LED RGB 220V, Control Remoto IR 28 Botones</p> <p>Controlador diseñado para tiras LED RGB alimentadas a 220V AC con mando a distancia RF (Radio Frecuencia) de 28 botones y 6 metros de alcance, con el que es posible gestionar de forma remota los canales RGB de una forma eficaz, gracias a su salida de 4A por canal. Con este controlador es posible seleccionar el color deseado y el efecto, al mismo tiempo que también es posible regular la intensidad y velocidad de las transiciones. Apto para longitudes de tira LED de hasta 40 metros y/o 600W.</p> | |
|  | ILED50CORGB | <p>Conector Tira LED SMD5050 RGB 220V AC</p> | |
|  | ILED50PINRGB | <p>Conector 4 PIN Tira LED RGB 220V SMD5050</p> | |
|  | ILED50C | <p>Cable Alimentador 220V AC IP65 Tira LED SMD5050</p> <p>Cada cable alimentador soporta un máximo de 20 metros de tira LED a 220V con chip SMD5050.</p> | |
|  | ILED50CU | <p>Cable Conector Tira LED SMD5050 Monocolor 220V AC</p> | |
|  | ILED50PIN | <p>Conector 2 PIN Tira LED Monocolor 220V SMD5050</p> | |
|  | ILED50CO | <p>Conector Tira LED SMD5050 Monocolor 220V AC</p> | |
|  | ILED50CLIP | <p>Grapa Fijación Tira LED 220V AC</p> | |
|  | ILED50TAP | <p>Tapón Final Tira LED 220V AC</p> | |