

artwork

KERASAN

L'ARTE CERAMICA INCONTRA IL DESIGN PIÙ ESSENZIALE

L'ambiente bagno nasce a nuova vita e diviene contenitore di inedite forme, che sanno d'arte e rompono con coraggio ogni schema prestabilito. I lavabi Moloco, gli orinatoi Groove e gli sgabelli Moscardino e Cow parlano il linguaggio della scultura, senza rinunciare all'essenzialità della funzione.

CERAMIC ART MEETS A MORE ESSENTIAL DESIGN

The bathroom takes on a new life to become home to new shapes, an artistic look that dares to go completely against every norm. The Moloco washbasins, Groove urinals and Moscardino and Cow stools speak of sculpture, yet do not dispense with the essential nature of their purpose.

artwork



La collezione Artwork ci trasporta in un mondo immaginario, dove non esiste il confine tra sogno e realtà, dove anche l'impossibile diventa possibile, dove gli oggetti della quotidianità si materializzano nella realtà, trasmettendoci le emozioni dei sogni e donandoci lo stupore della fanciullezza. La natura ci insegna che la forma è determinata dalla funzione da espletare: questi oggetti materici, queste forme ispirate alla natura ci colpiscono e ci sorprendono per la loro originalità e per la loro collocazione. La materia nobile con cui sono create, attraverso la lavorazione di mani esperte e l'uso di alta tecnologia, origina sculture, opere d'arte di forte impatto visivo, elementi d'arredo che trascendono la funzione per farsi icone di modernità senza tempo.

Artwork collection takes us to an imaginary world where there is no boundary between dreams and reality, where even the impossible becomes possible. Objects from everyday life materialise in reality and bless us with the emotions of dreams and childhood wonder. Nature teaches us that shape is determined by the function to be performed: these textural objects, along with forms inspired by nature, amaze and surprise us in virtue of their variety and placement. Noble materials, expert craftsmanship and the application of state-of-the-art technology are all used to produce art works of high visual impact, furnishing elements which transcend function and become timeless icons of modernity.



MOLOCO
45 X 51 X H94 CM



GROOVE
28 X 35 X H130 CM



COW
67 X 18 X H71 CM



MOSCARDINO
40 X 40 X H61 CM

6.

moloco





IL DESIGN HA UN NUOVO VOLTO

Una figura avvolta nel mistero, una maschera indefinibile: enigma, curiosità e design aprono il bagno a nuove contaminazioni e sperimentazioni.

DESIGN HAS A NEW FACE

A figure wrapped in mystery, an undefinable mask: enigma, curiosity and design open up the bathroom to new renderings and experiments.

**4740/4741**

Moloco lavabo / Moloco washbasin

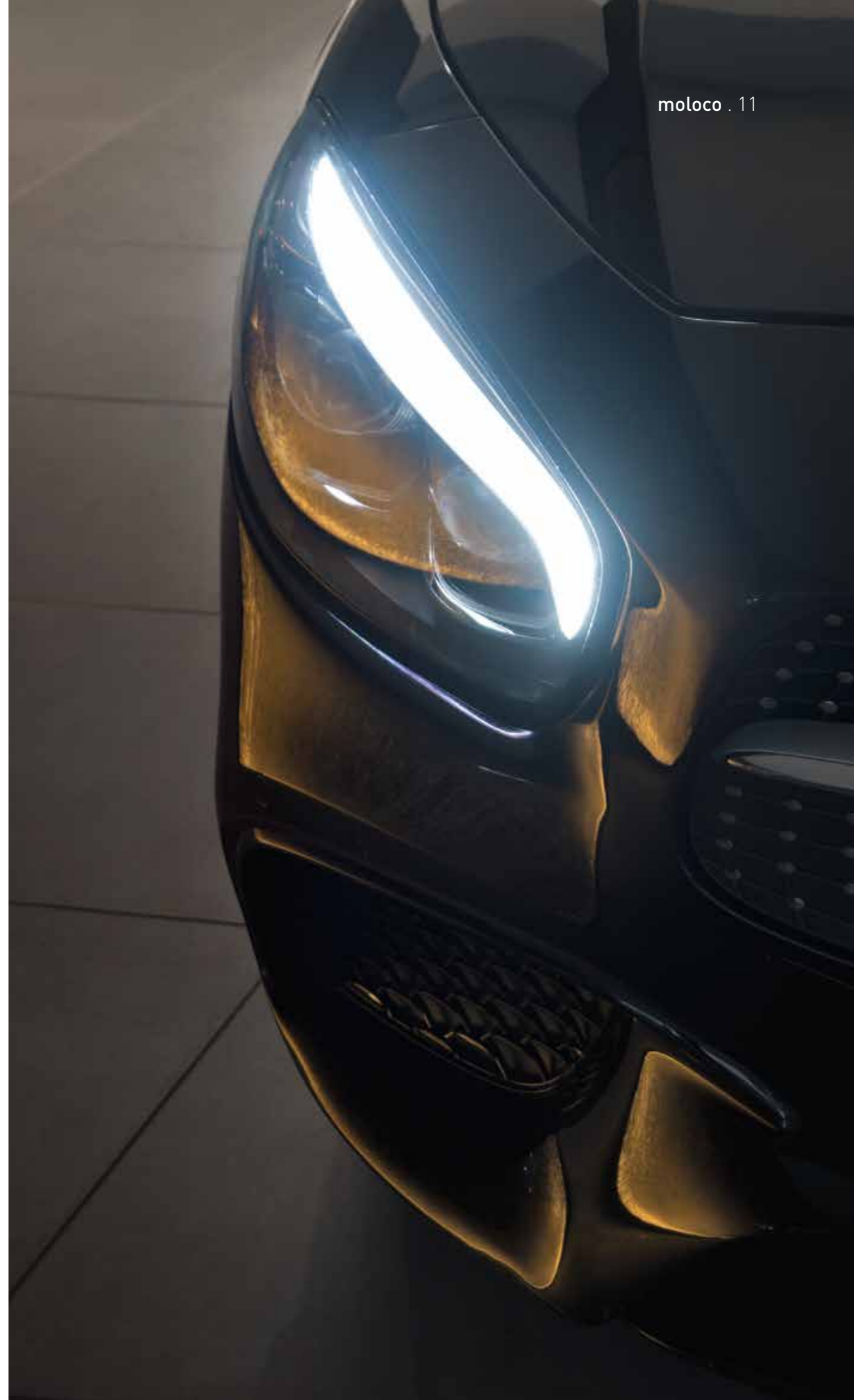



4740/4741
Moloco lavabo / Moloco washbasin





4740/4741
Moloco lavabo / Moloco washbasin
7561
Miscelatore da terra / Floor mounted basin mixer





4740/4741
 Moloco lavabo luxury oro / Washbasin moloco white/luxury gold
 Moloco lavabo luxury platino / Washbasin moloco white/luxury platinum



groove







L'ESSENZIALITÀ PRENDE FORMA

Tra rigore delle linee e morbidezza della forma non esiste alcun contrasto. Eleganza, leggerezza e ceramica diventano un'armonia unica di sensi ed emozioni.

ESSENTIAL TAKES SHAPE

There is absolutely no conflict between the severity of the lines and the softness of the shape. Elegance, lightness and ceramics work together to create a unique harmony of senses and emotions.

**4730**

Groove orinatoio / Urinal Groove





4730
Groove orinatoio / Urinal Groove
7562
Bocca di erogazione / Spout for urinal







4701
Cow sgabello / Stool Cow

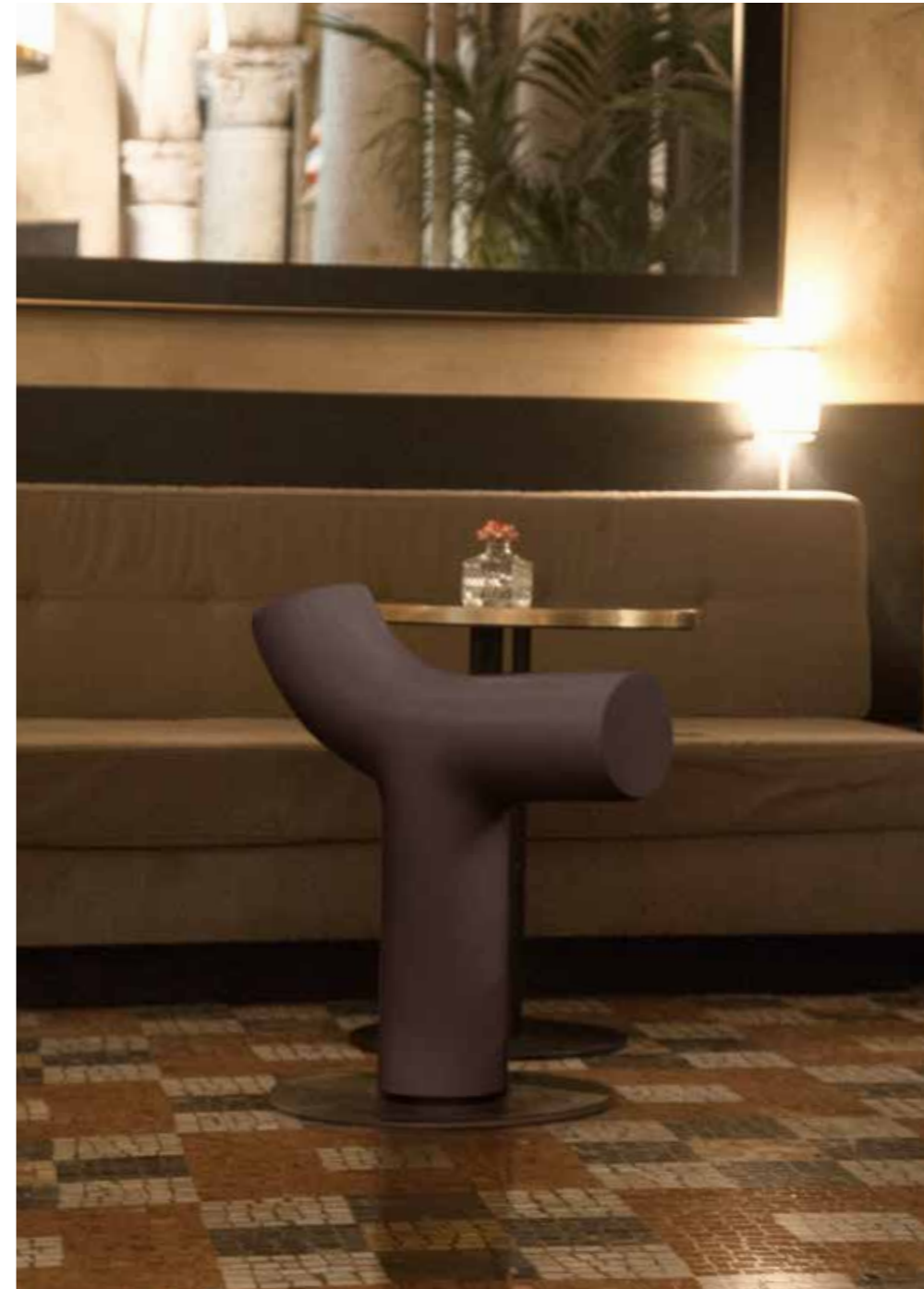



4701
Cow sgabello / Stool Cow



**CREATIVITÀ E DESIGN TROVANO
IL LORO POSTO IDEALE**

Lo spazio ideale dove design, dinamismo ed unicità
si accomodano nel modo più elegante.

**CREATIVITY AND DESIGN
FIND THEIR PERFECT SPOT**

The ideal space where design, dynamics and uniqueness
make themselves comfortable in the most elegant of ways.



4701
Cow sgabello / Stool Cow

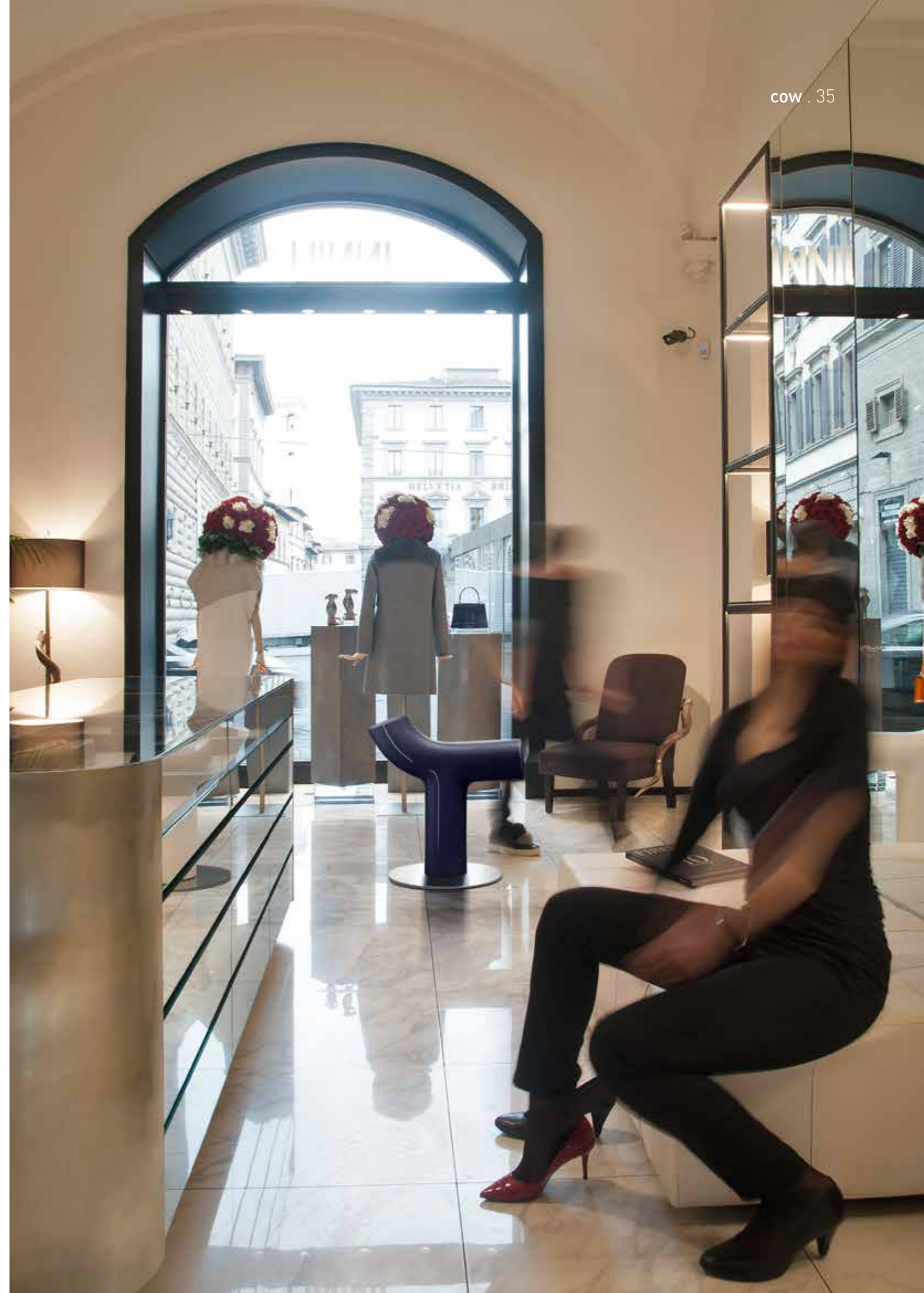



moscardino





4702
Moscardino sgabello / Stool Moscardino

LA CERAMICA IN VERSIONE 2.0

Nuovi oggetti, nuovi mondi, nuove ispirazioni. La ceramica supera i confini dell'immaginario e dà vita a forme di design tentacolari che seducono il nostro spazio quotidiano.

CERAMICS VERSION 2.0

New art, new worlds, new inspirations. Ceramics take a step outside the box to give life to tentacle designs that seduce our everyday space.





4702
Moscardino sgabello / Stool Moscardino

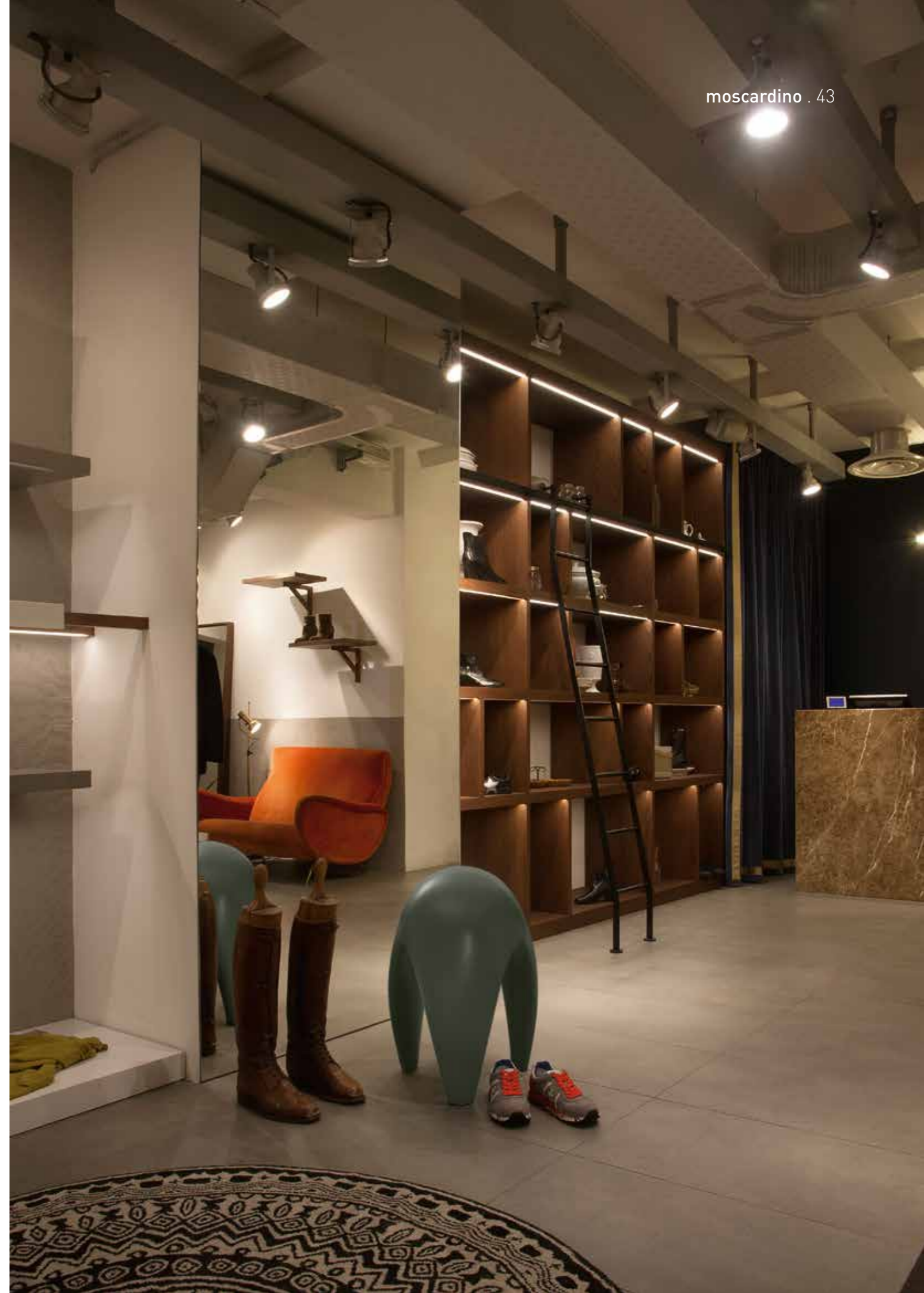



4740 Lavabo freestanding Moloco scarico a parete
Freestanding washbasin Moloco wall outlet

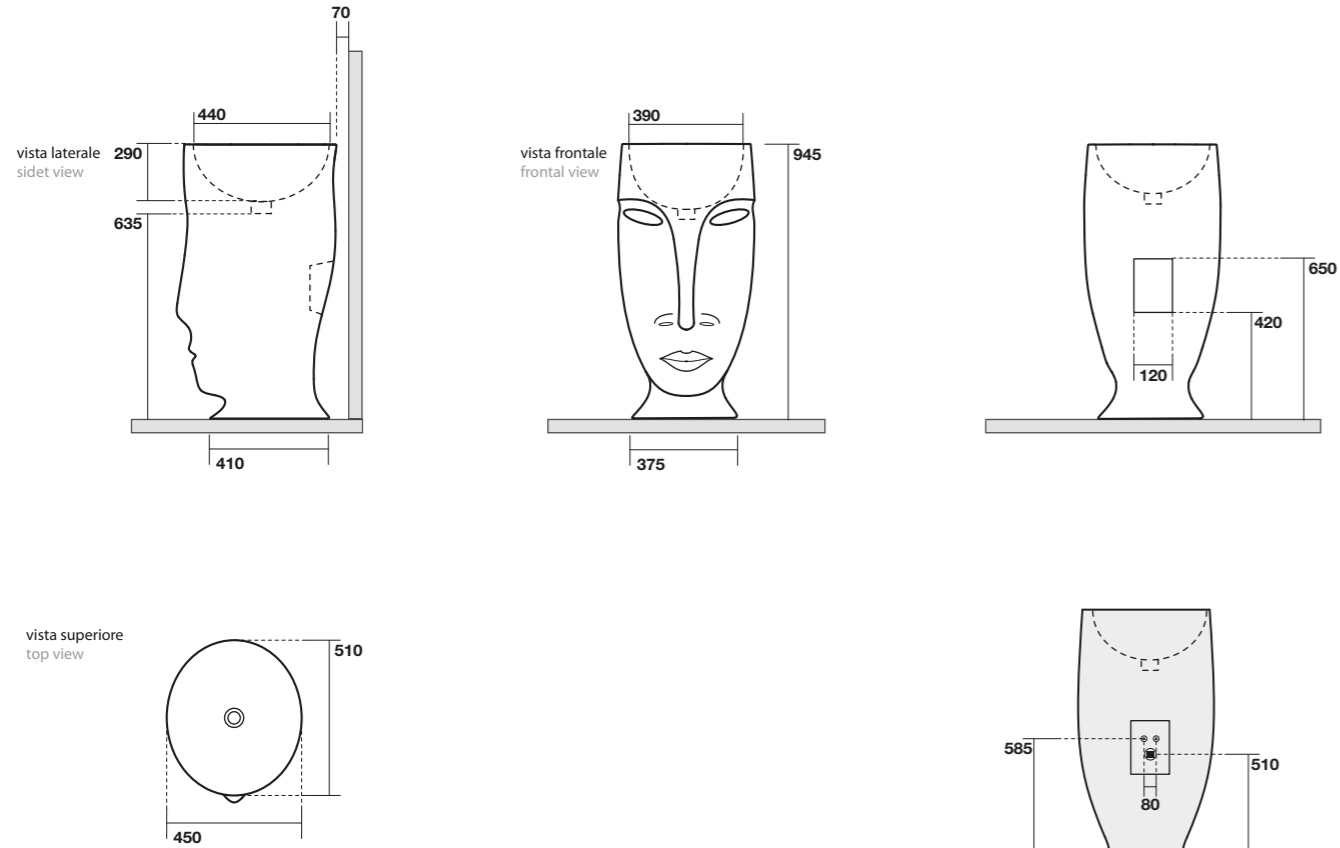

4741 Lavabo freestanding Moloco scarico suolo completo di sifone e tubo flessibile di scarico
Freestanding washbasin Moloco floor outlet siphon and flexible waste pipe included

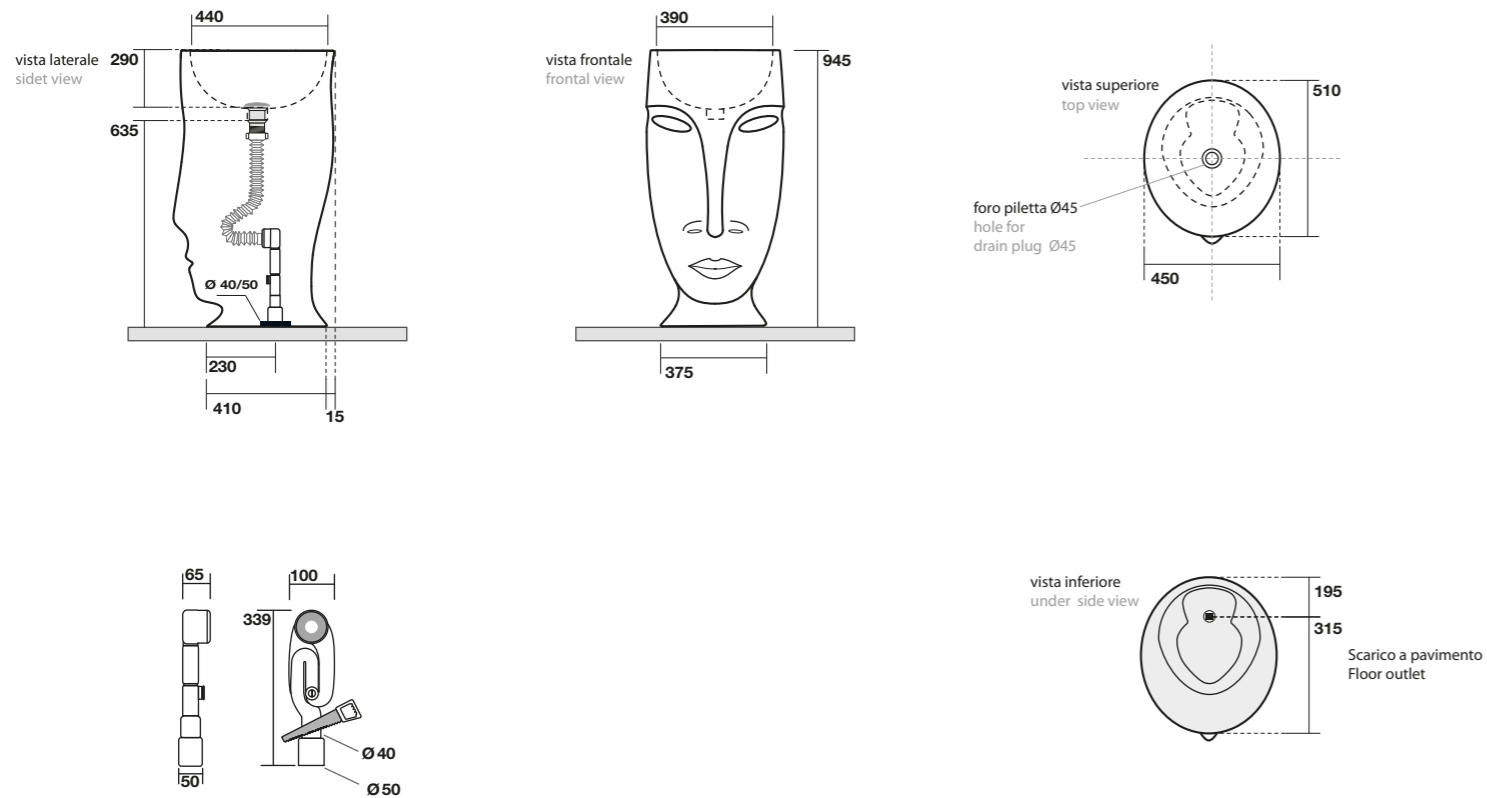

7560 Miscelatore lavabo incasso inox satinato
Stainless steel satin built-in lever basin mixer

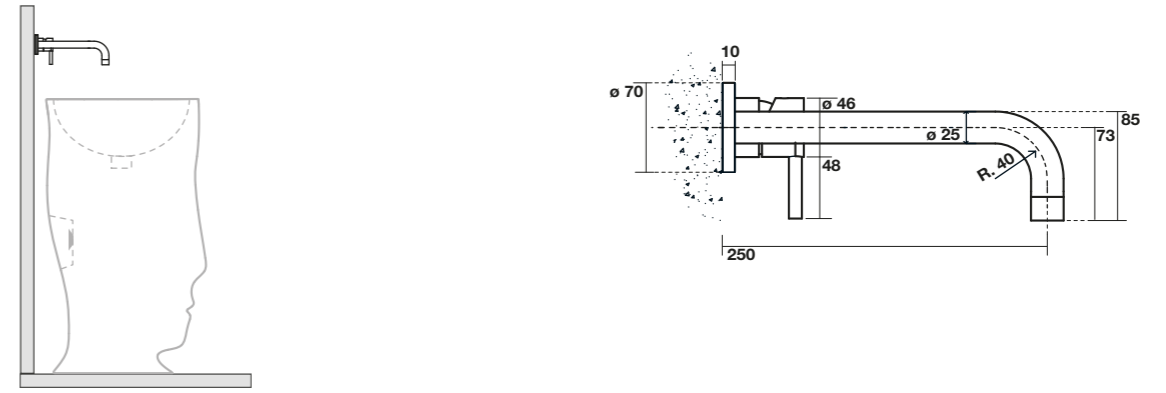

7561 Miscelatore progressivo da terra inox satinato
Stainless steel satin floor mounted basin progressive mixer

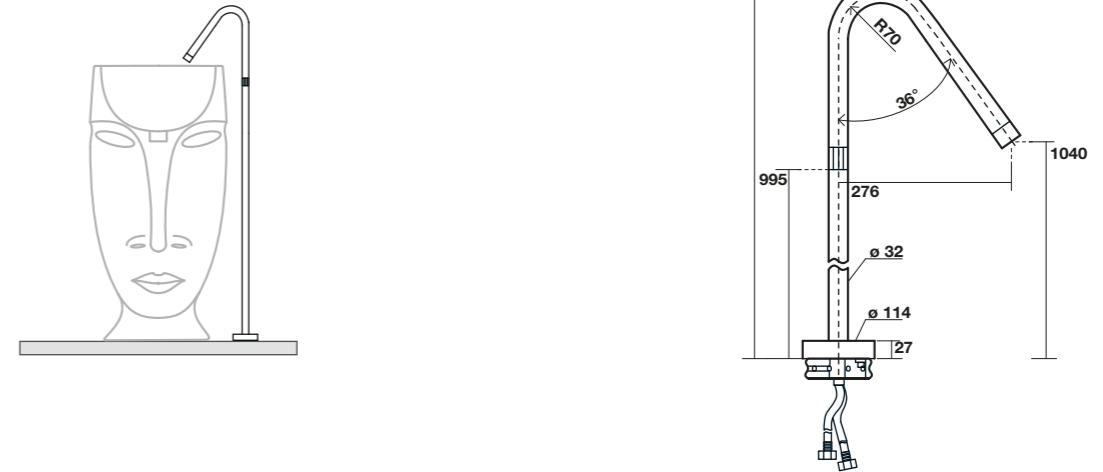

7562 Bocca di erogazione per orinatoio Groove inox satinato
Stainless steel satin floor mounted spout for orinal Groove

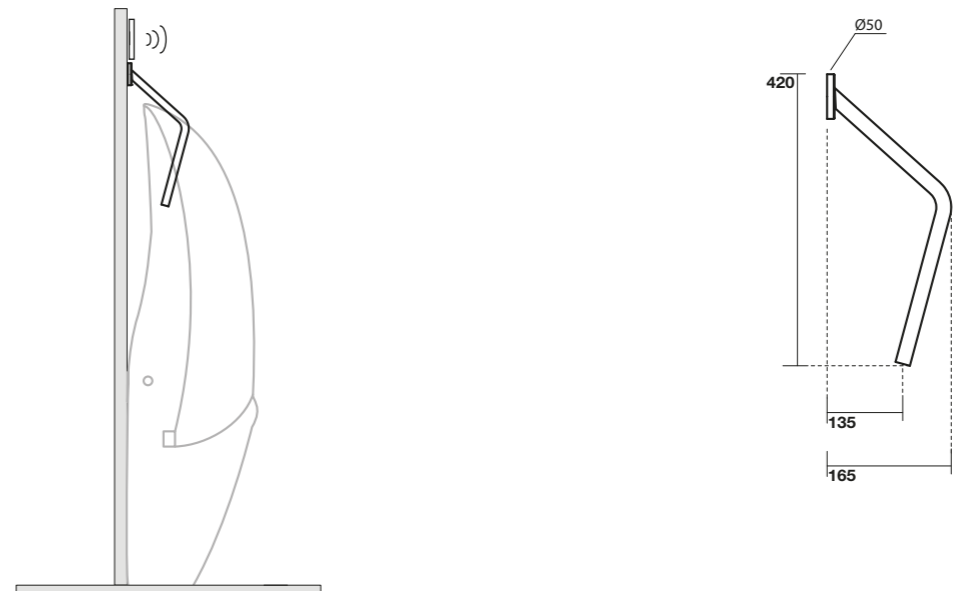

4730 Orinatoio Groove completo di fissaggio e sifone
 Urinal Groove fixings screws and siphon included

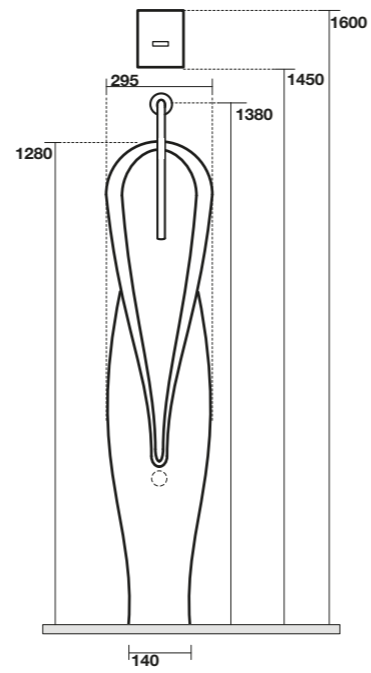
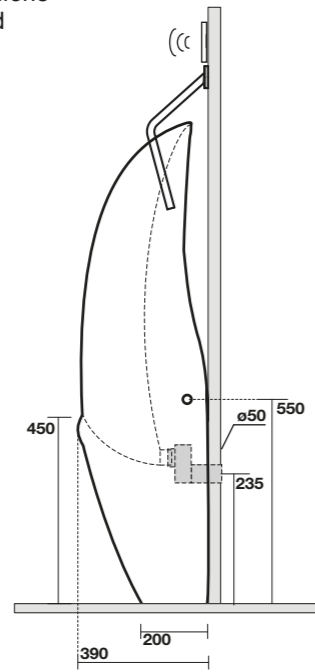
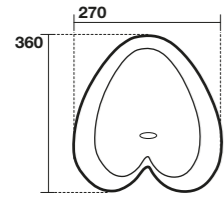

7564 Sistema di comando con pulsante 9v in acciaio inossidabile per orinatoio
 Urinal control with push button 9v of stainless steel

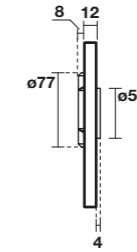
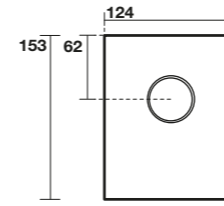

7565 Dispositivo di cacciata a parete per orinatoio
 Concealed urinal flush valve

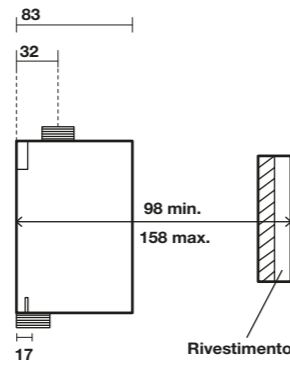
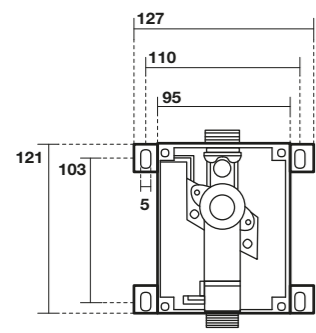

4702 Sgabello Moscardino
 Stool Moscardino

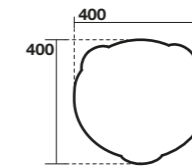
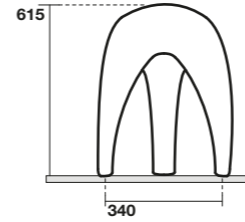

7563 Sistema di comando con sensore 9v in acciaio inossidabile per orinatoio
 Urinal control with sensor 9v of stainless steel

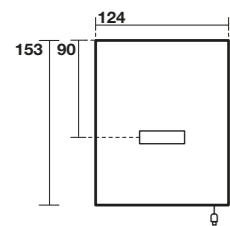

4701 Sgabello Cow completo di base in acciaio inox
 Stool Cow stainless steel base included

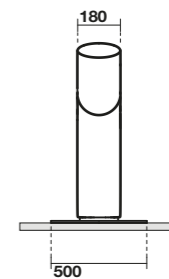
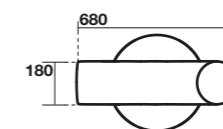
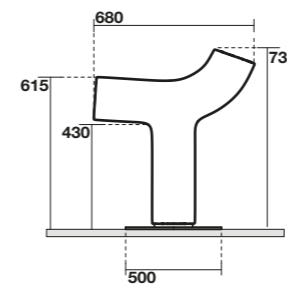

COLORI CERAMICA
CERAMIC GLAZES



BIANCO LUCIDO
 GLOSSY WHITE



NERO LUCIDO
 GLOSSY BLACK



BLU COBALTO LUCIDO
 GLOSSY COBALT BLUE



BIANCO-NERO LUCIDO
 WHITE-SHINY BLACK



BIANCO-BLU COBALTO LUCIDO
 WHITE-GLOSSY COBALT BLUE



BIANCO-NERO MATT
 WHITE-MATT BLACK

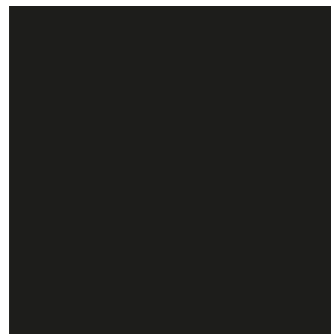

NERO MATT
 MATT BLACK

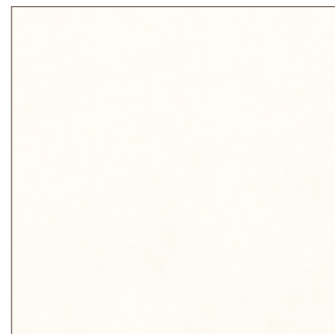

BIANCO MATT
 MATT WHITE

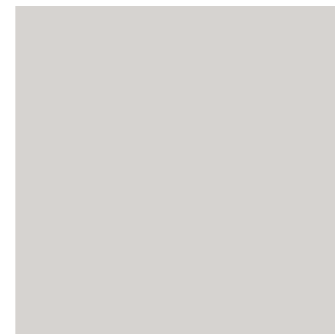

GRIGIO MATT
 MATT GRAY



BIANCO-BIANCO MATT
 WHITE-MATT WHITE



BIANCO-GRIGIO MATT
 WHITE-MATT GRAY



BIANCO-TERRA MATT
 WHITE-MATT EARTH



TERRA MATT
 MATT HEART

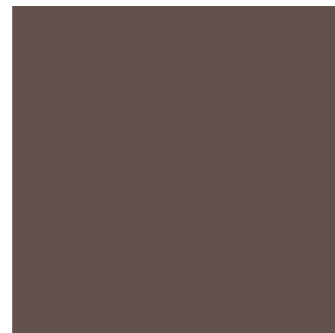

BORGOGNA MATT
 MATT BORGOGNA



VERDE MATT
 MATT GREEN



BIANCO-BORGOGNA MATT
 WHITE-MATT BORGOGNA

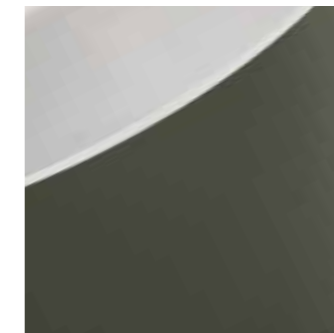

BIANCO-VERDE MATT
 WHITE-GREEN MATT



BIANCO-CIPRIA MATT
 WHITE-MATT CIPRIA

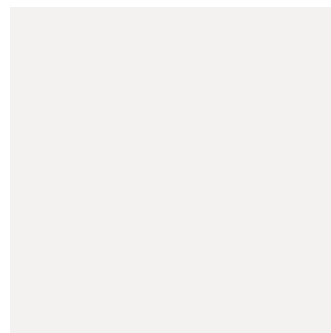

CIPRIA MATT
 MATT CIPRIA

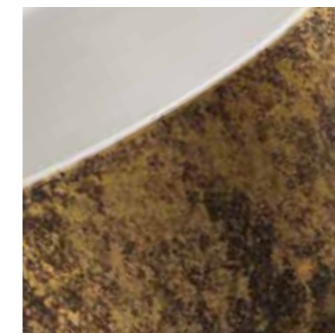

BIANCO-LUXURY ORO
 WHITE-LUXURY GOLD

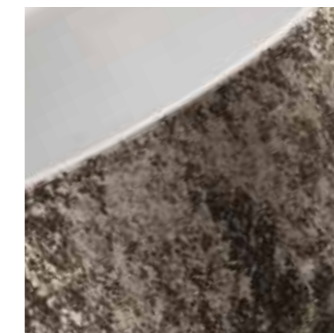

BIANCO-LUXURY PLATINO
 WHITE-LUXURY PLATINUM

La Kerasan si riserva di apportare in qualsiasi momento modifiche tecniche, costruttive e dimensionali utili al miglioramento dei propri prodotti; pesi e misure sono da considerarsi indicativi. La tonalità degli smalti dei sanitari, a causa delle peculiarità della lavorazione ceramica, sono suscettibili di lievi variazioni da considerarsi in tolleranza. Gli allestimenti fotografici sono realizzati a fini estetici e non indicano soluzioni d'installazione.

Kerasan has the right to make any change to improve its products anytime; weights and sizes are for information only. The tonalities of glazes on sanitary ware are subject to light alterations due to the peculiarity of the production process, the alterations have to be considered as tolerance. The settings have been realized for aesthetic use only, they just suggest interior bath decorations.

Art direction + Graphic project
Gonnelli&Associati comunicazione

photo
Roberto Costantini

print
Telligraf

Copyright© 6/2017 KERASAN

Thanks to:

Gmg Spa - Sovigliana (FI)
Link Fitness Club - Sovigliana (FI)
Calzoleria Marzuoli - Empoli (FI)
Odeon Bistro - Firenze
Osteria Delle Brache - Firenze
Inniu Italy - Firenze

KERASAN

Kerasan srl
Via A. Einstein, 3
01033 Civita Castellana (VT) - ITALY
Tel. (+39) 0761 542018 (ra) - Fax (+39) 0761 540627

kerasan@kerasan.it
www.kerasan.it

