

TARIFA 2019



ESENCIAL PARA TI.

Durante más de 100 años, Ideal Standard ha ejercido su influencia en el sector sanitario siendo Líder en innovación. Nuestra experiencia en cerámica, grifería y accesorios nos permite ofrecer soluciones integrales de gran calidad para espacios de baño.

Nuestro trabajo consiste en inspirarles con nuevas opciones de lo que es posible. Después de todo, sabemos que usted exige más eficiencia, mejor higiene, mayor comodidad, mejor diseño y nuevas experiencias.

Trabajamos para darle acceso a las últimas tecnologías y ayudarle a encontrar la respuesta adecuada, sea cual sea el producto o servicio que necesite. Nuestra misión es servirle y proporcionarle ideas y soluciones que le ayuden a desarrollar sus proyectos.



Ideal Standard

ÍNDICE

01	GRIFERÍA	08
02	CERÁMICA	138
03	LAVABOS	232
04	MUEBLES Y ESPEJOS	288
05	WELLNESS	324
06	COLECTIVIDADES	364
07	REPUESTOS	392

GUÍA DE LECTURA

Encuentra lo que buscas sin perder tiempo. A continuación te facilitamos la información necesaria para que puedas encontrar de forma precisa la solución a tus necesidades. Tablas de categorización de productos, por características, matriz de compatibilidades de muebles y lavabos... Todo pensado para facilitarte tu trabajo.

CERÁMICA
SANITARIOS

Pluralidad de formas y estilos unidos por un componente común: un diseño único.

INODORO A PARED TANQUE BAJO	TONIC II 425 €/Ud. Pág. 161	CONNECT AIR 375 €/Ud. Pág. 175	CONNECT 350 €/Ud. Pág. 183	CONNECT SPACE 365 €/Ud. Pág. 191	
INODORO SUSPENSIÓN	TONIC II 500 €/Ud. Pág. 160	STRADA II 375 €/Ud. Pág. 166	CONNECT AIR 340 €/Ud. Pág. 174	CONNECT 250 €/Ud. Pág. 182	CONNECT SPACE 255 €/Ud. Pág. 190
INODORO A PARED TANQUE ALTO	TONIC II 400 €/Ud. Pág. 160	STRADA II 265 €/Ud. Pág. 166	CONNECT AIR 260 €/Ud. Pág. 174	CONNECT 220 €/Ud. Pág. 182	
INODORO ABIERTO	CONNECT 350 €/Ud. Pág. 183				

148 | SANITARIOS

Los precios indicados son de la versión con asiento normal y sin codo técnico

TABLA DE CATEGORIZACIÓN POR TIPOLOGÍA DE PRODUCTO

CATEGORIZACIÓN GRIFERÍA PÁG. 18
CATEGORIZACIÓN SANITARIOS PÁG. 148

CATEGORÍA DE PRODUCTO

COLECCIÓN

NOVEDAD

P.V.P / N° PÁGINA

TABLA DE CATEGORIZACIÓN POR CARACTERÍSTICAS

CATEGORÍA DE PRODUCTO

COMPONENTES DE PRODUCTO / CERTIFICACIONES

COLECCIÓN

CARACTERÍSTICAS DE PRODUCTO / CERTIFICACIONES

CERÁMICA
SANITARIOS

		TONIC II	CONNECT AIR	CONNECT
INODORO	CORTA PROYECCIÓN			<input checked="" type="checkbox"/>
	PROYECCIÓN	665mm	665mm	665mm
	SALIDA	DUAL	DUAL	DUAL
	DISTANCIA DESAGÜE A PARED	210mm	210mm	210mm
	CCODO	No incl. opcional	No incl. opcional	No incl. opcional
	AQUILADE	<input checked="" type="checkbox"/>		<input checked="" type="checkbox"/>
	BRIDA NORMAL			<input checked="" type="checkbox"/>
	PACK DISPONIBLE	Inodoro + Asiento		
	ORIFICIOS LATERALES			<input checked="" type="checkbox"/>
	ASIENTO FINO		<input checked="" type="checkbox"/>	<input checked="" type="checkbox"/>
ASENTO	ASIENTO ENVOLVENTE	<input checked="" type="checkbox"/>	<input checked="" type="checkbox"/>	<input checked="" type="checkbox"/>
	CIERRE AMORTIGUADO	<input checked="" type="checkbox"/>	<input checked="" type="checkbox"/>	<input checked="" type="checkbox"/>
	CIERRE NORMAL		<input checked="" type="checkbox"/>	<input checked="" type="checkbox"/>
	EXTRACCIÓN FÁCIL*	<input checked="" type="checkbox"/>	<input checked="" type="checkbox"/>	<input checked="" type="checkbox"/>
TANQUE	ALIMENTACIÓN	Inferior	Inferior	Inferior/Lateral
	LITROS DESCARGA	4,5/3L	4,5/3L	6/3L
	ANGULAR	NO	NO	NO
	BREAR Y LEED	<input checked="" type="checkbox"/>	<input checked="" type="checkbox"/>	<input checked="" type="checkbox"/>
CERTIFICACIONES				
* Asientos Soft				

		CONNECT	CONNECT FREEDOM ELEVADO	TE3
INODORO	PROYECCIÓN	665 mm	650 mm	660 mm
	SALIDA	SV+ SH	DUAL	DUAL
	DISTANCIA DESAGÜE A PARED	210mm	210mm	210mm
	CCODO		Opcional	Opcional
	AQUILADE	<input checked="" type="checkbox"/>		<input checked="" type="checkbox"/>
	BRIDA NORMAL	<input checked="" type="checkbox"/>		<input checked="" type="checkbox"/>
	PACK DISPONIBLE			
	ASIENTO FINO	<input checked="" type="checkbox"/>	<input checked="" type="checkbox"/>	<input checked="" type="checkbox"/>
	ASIENTO ENVOLVENTE	<input checked="" type="checkbox"/>	<input checked="" type="checkbox"/>	<input checked="" type="checkbox"/>
	CIERRE AMORTIGUADO	<input checked="" type="checkbox"/>	<input checked="" type="checkbox"/>	<input checked="" type="checkbox"/>
ASENTO	CIERRE NORMAL		<input checked="" type="checkbox"/>	<input checked="" type="checkbox"/>
	EXTRACCIÓN FÁCIL*	<input checked="" type="checkbox"/>	<input checked="" type="checkbox"/>	<input checked="" type="checkbox"/>
	ALIMENTACIÓN	Inferior/Lateral	Inferior/Lateral	Inferior/Lateral
	LITROS DESCARGA	6/3L	6/3L	4,5/3L
TANQUE	ANGULAR		<input checked="" type="checkbox"/>	
	BREAR Y LEED			<input checked="" type="checkbox"/>
CERTIFICACIONES				
* Asientos Soft				

150 | SANITARIOS

PÁGINA DE PRODUCTO

CARACTERÍSTICAS TÉCNICAS | ICONOGRAFÍA

COLECCIÓN

IMAGEN DE PRODUCTO

CATEGORÍA DE PRODUCTO

COMPONENTES DE PRODUCTO

DIBUJO TÉCNICO

REFERENCIA DE PRODUCTO

PVP

STOCK

Disponibilidad inmediata para productos marcados como stock. Para productos no marcados preguntar disponibilidad.

PEDIDO MÍNIMO

Pedido mínimo para obtener el primer escalado de descuento.

SANITARIOS TONIC II

INODORO SUSPENDIDO

Acabado: Blanco Brillo	Ref.	€/Ud.	Stock	Cant.	Características técnicas
Inodoro AQUABLADE Fijación oculta	K316001	415	6	6	
Asiento y tapa envolvente con cierre amortiguado	K706501	85	6	6	
PACK inodoro + tapa envolvente con cierre amortiguado	K316701	500	6	6	

INODORO A PARED TANQUE ALTO

Acabado: Blanco Brillo	Ref.	€/Ud.	Stock	Cant.	Características técnicas
Inodoro AQUABLADE Fijación oculta y salida dual	K316201	315	6	6	
Asiento y tapa envolvente con cierre amortiguado	K706501	85	6	6	
PACK inodoro + tapa envolvente con cierre amortiguado*	K317501	400	6	6	

* Codo salida vertical no incluido

Opcional para hacer salida vertical, solicitar el código:

Ref.	€/Ud.	Stock	Cant.
Codo 90º recto	WW965742	20	6

BIDÉ SUSPENDIDO

Acabado: Blanco Brillo	Ref.	€/Ud.	Stock	Cant.	Características técnicas
Bidé Fijación Oculta	K523601	255	6	6	

BIDÉ A PARED

Acabado: Blanco Brillo	Ref.	€/Ud.	Stock	Cant.	Características técnicas
Bidé	K523801	245	6	6	

160 | SANITARIOS

CERÁMICA SANITARIOS IDEAL STANDARD

INODORO PARED TANQUE BAJO

Acabado: Blanco Brillo	Ref.	€/Ud.	Stock	Cant.	Características técnicas
Inodoro AQUABLADE Salida dual	K316001	340	6	6	
Tanque 4.5/3L Tonic II All	K404901	242	6	6	
Asiento y tapa envolvente con cierre amortiguado	K706501	85	6	6	
PACK inodoro + tapa envolvente con cierre amortiguado* (Tanque no incluido)	K316901	425	6	6	

* Codo salida vertical no incluido

Opcional para hacer salida vertical, solicitar el código:

Ref.	€/Ud.	Stock	Cant.
Codo 90º recto	WW965742	20	6

ACCESORIOS TONIC II

Acabado: Blanco Brillo	Ref.	Stock	Cant.	€/Ud.	Características técnicas
Tanque 4.5/3L All	K404901	6	6	242	
Asiento y tapa envolvente con cierre amortiguado	K706501	6	6	85	

REPUESTOS TONIC II

Acabado: Neutro	Ref.	Dónde se usa	€/Ud.
Kit fijación a suelo inodoro bidé	TT0257919	K316001 - K316901 - K316201 - K317501 - K523801	5
Kit fijación oculta inodoro o bidé suspendidos	TT0299327	K318801 - K316701 - K523601	25
Acabado: Cromo brillo	Ref.	Dónde se usa	€/Ud.
Biagras cierre amortiguado	TV110AA	K706501	60
Acabado: Blanco	Ref.	Dónde se usa	€/Ud.
Juego de topos asiento Tonic II	TV10767	K706501	10

SANITARIOS | 161

PÁGINA DE REPUESTOS

Consulta los repuestos de cada producto en la última página de cada serie.

TIPOLOGÍA DE PRODUCTO

REFERENCIA DE PRODUCTO

PRODUCTO DONDE SE USA

IMAGEN DE PRODUCTO

IDEAL STANDARD

BUSCAMOS LA SOSTENIBILIDAD

Asumir completamente nuestras responsabilidades ambientales, dominar los impactos de la construcción o rehabilitación, administrar de manera sostenible nuestro recurso más preciado, el agua, son parte de nuestros compromisos.



Ideal Standard trabaja para desarrollar soluciones eficientes y respetuosas y ofrecer así los productos que demandan nuestros clientes para cumplir con una legislación cada vez más estricta. Por ello, un gran número de nuestros productos cumplen las exigencias de las certificaciones LEED y BREEAM.

En Ideal Standard estamos comprometidos con el Medio Ambiente y trabajamos para conseguir productos más eficientes.

En el caso de nuestras griferías limitamos el caudal principalmente a través de los aireadores en los grifos o de limitadores de caudal en las teleduchas.

En griferías con especificaciones técnicas que así lo requieran limitamos el caudal a través del cartucho mezclador.

Diseñamos nuestros sanitarios con el fin de que sean lo más eficientes posible, reduciendo el consumo de agua en cada uso.

De este modo cada vez contamos con un mayor catálogo de productos que cumplen con las especificaciones de las certificaciones LEED y BREEAM.

Puede consultarnos cuales de nuestros productos cumplen estas especificaciones.



Leadership in Energy and Environmental Design.



Building Research Establishment Environmental Assessment Method (BREEAM®).

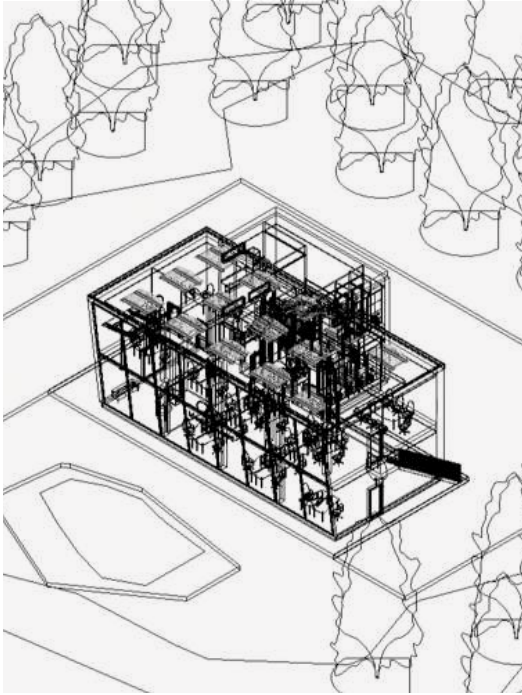

IDEAL STANDARD

METODOLOGÍA BIM

BIM (Building Information Modeling) es una metodología de trabajo colaborativa para la gestión de proyectos de edificación u obra civil a través de una maqueta digital. Esta maqueta digital conforma una gran base de datos que permite gestionar los elementos que forman parte de la infraestructura durante todo el ciclo de vida de la misma.

La metodología BIM está suponiendo una verdadera revolución tecnológica para la cadena de producción y gestión de la edificación y las infraestructuras. Esta herramienta permite construir de una manera más eficiente, reduciendo costes al tiempo que permite a proyectistas, constructores y demás agentes implicados trabajar de forma colaborativa.



¿CÓMO PUEDE AYUDARLE LA METODOLOGÍA BIM?

BIM recopila toda la información sobre cada componente de un edificio en un archivo. BIM hace posible que cualquier profesional pueda acceder a esa información para distintos propósitos. De ese modo el riesgo de errores o discrepancias se reduce y los costes se minimizan.

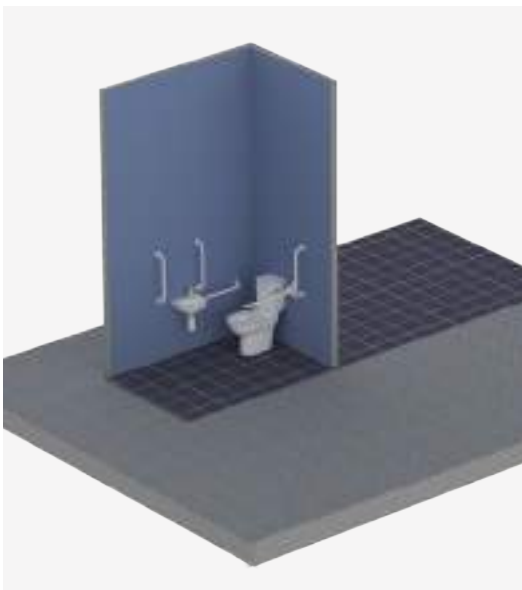

MÁS ALLÁ DEL PRODUCTO PARA FACILITAR SU TRABAJO

El futuro de la industria de la construcción es digital y BIM es el futuro del diseño, mantenimiento y gestión a largo plazo de edificios; está siendo implantado por la mayoría de los gobiernos de Europa y está promoviendo el cambio en la industria.

Ideal Standard ha sido uno de los primeros fabricantes en incluir la creación de archivos BIM en el proceso de desarrollo de nuestros nuevos productos en 2013; en estos momentos disponemos de más de 4000 archivos BIM de productos de nuestro portfolio, cantidad que se va a ver incrementada año tras año.

Todos nuestros archivos BIM han sido desarrollados desde la fase de prototipo hasta el producto final por nuestros expertos en producto e ingenieros para asegurar un 100% de precisión.

IDEAL STANDARD

SOLUCIONES PARA TODOS

Porque un sector de actividad no se parece a otro, porque una obra en construcción es siempre una operación compleja.



SECTOR RESIDENCIAL

Casas individuales o edificios colectivos, nuevos o en rehabilitación... nuestra amplia gama de soluciones de baños nos permite responder a todos los deseos y necesidades para crear un baño personalizable, ideal y fácil de instalar.



SECTOR CORPORATIVO

Oficinas, edificios industriales y públicos, deben estar equipados con soluciones higiénicas, accesibles, resistentes y eficientes. En nuestro catálogo puede encontrar la respuesta a sus necesidades.



SECTOR HOTELERO

Hoteles de 2 a 5*. Con el apoyo de estudios de diseño europeos de renombre, combinamos la estética con la funcionalidad buscando la facilidad de limpieza, el rendimiento, la sostenibilidad, la ergonomía y la eficiencia en el uso del agua y energía. La colección Connect Air es un ejemplo perfecto.





SECTOR EDUCACIÓN

Un baño escolar juega un papel vital en el edificio, otorgando un ambiente positivo y de calidad. Inodoros de tamaño reducido para jardines de infancia a urinarios a prueba de vandalismo o sin agua para las escuelas secundarias, pasando por lavabos colectivos, nuestros productos están en el corazón de las necesidades del sector de la educación del siglo XXI.



SECTOR HOSPITALARIO

Son importante los problemas de salud pública, las condiciones de salud y seguridad, las instalaciones sanitarias en la atención está sujeta a protocolos y reglas estrictas establecidas por las autoridades públicas. Los hospitales luchan más que nunca contra los riesgos de infección y configuran medidas de prevención rigurosas.

Nuestras gamas

Contour 21 en sanitarios y Ceraplus II en grifería han sido especialmente diseñados para cumplir con las necesidades de higiene, ergonomía y seguridad.



SECTOR PÚBLICO

Aeropuertos, estaciones de tren, estaciones de servicio, estadios son lugares de gran circulación y que requieren una gran exigencia en términos de anti vandalismo, gestión costes de uso y mantenimiento



IDEAL STANDARD

GRIFERÍA

Un diseño para cada casa y necesidad,
adaptados a tu estilo y al de tu hogar.

GRIFERÍA TRADICIONAL	26
TERMOSTÁTICAS	88
DUCHAS	96
GRIFERÍA ESPECIALIZADA	114
COCINA	128



AHORRO DE AGUA Y ENERGÍA



Ahorro de energía BlueStart®

Apertura en frío: La grifería está configurada para que solo salga agua fría cuando se abra el grifo en la posición central.

Ángulo de apertura a 90°: gira la palanca desde el centro (posición fría) hacia el lado izquierdo para alcanzar la temperatura deseada.

Evita el calentamiento innecesario del agua y, como tal, reduce el consumo de energía.



LIMITADOR DE TEMPERATURA



Ahorro de Agua

La tecnología Click con un stop mecánico limita el caudal de agua a lo que se necesita para lavar las manos (5 l/min en monomando lavabos frente a los 9 litros). Con el paso del tiempo esto significa un ahorro mayor de agua en hoteles, oficinas, etc.

El caudal también es más eficiente. El caudal se mantiene constante incluso cuando la temperatura se ajusta en cualquiera de los sentidos del grifo.



5 L/MIN REDUCTOR DE CAUDAL



Mayor duración

Diseñado y producido en Alemania, nuestro nuevo cartucho cerámico es el mejor que hemos fabricado jamás. ¡Y eso es decir mucho, ya que los inventamos nosotros!

El diseño es más fino y también más duradero. Cada parte tiene su propósito y encaja a la perfección optimizando el encaje dentro del cuerpo del grifo.

La carcasa del cartucho ha sido mejorada con un plástico nuevo y técnicamente superior. Dura más porque es más resistente soportando aperturas de 95 grados frente a los 80 grados estándar.

Los **discos cerámicos** dentro del cartucho han sido rediseñados para garantizar el sellado mientras se garantiza la sensibilidad en los controles.

Las palancas del cartucho se han mejorado con pivotes metálicos que garantizan el ajuste perfecto incluso después de una vida usándolo. Además el adaptador de flujo ha sido forjado en acero inoxidable (anteriormente en plástico) para incrementar la duración.

El resultado es un cartucho que dura aproximadamente el doble que el estándar en nuestra industria (1.500.000 ciclos frente a los comunes 300.000) ofreciendo al consumidor de 10 a 15 años de uso diario.



En 1960 Ideal Standard revolucionó la gestión del agua en el baño con la invención del cartucho cerámico para los grifos monomando.



DURACIÓN

Y FINURA A LA PAR



1,500,000

TESTADO EN CICLOS



10-15

AÑOS DE USO DIARIO



SUAVIDAD

EN EL MANEJO PARA OPTIMIZAR LA PRECISIÓN Y EL CONFORT

INNOVACIONES FUNCIONALES



Easy Fix

Un **único tornillo de acero inoxidable** combinado con un sellado especial y una fijación metálica antideslizante sujeta y centra el mezclador automáticamente, con un **ahorro de tiempo de instalación de hasta el 30%**.

1. Saque el grifo de la caja y verifique que esté completo de acuerdo con las especificaciones de fabricación.
2. Coloque el grifo sobre el lavabo con los latiguillos flexibles a través del orificio de instalación.
3. Monte la placa de anclaje y junta de goma en el tornillo y apriételo. La grifería quedará fijada de un modo sencillo.



Cool Body

100% de seguridad en el baño con la tecnología Cool body de Ideal Standard.

Protección total contra quemaduras fortuitas gracias al sistema de aislamiento Cool body que garantiza la ausencia de puntos calientes en el cuerpo de la grifería para una total tranquilidad y un mayor confort.

Con la tecnología Cool body el cuerpo exterior de metal es independiente de las áreas de circulación del agua. Esta característica innovadora que permite a los usuarios apoyarse en el cuerpo de la

grifería evitando cualquier tipo de quemadura.

UNE – EN 1717. Garantizamos los medios utilizados para prevenir la contaminación del agua potable, dentro de las premisas y requisitos generales de los dispositivos de protección para evitar la contaminación por reflujo del agua.



Easy Box

Ideal Standard está a la cabeza con su tecnología avanzada que incorpora a todas las posibles instalaciones.

Ideal Standard en colaboración con un grupo de expertos ha llevado la tecnología de sistemas integrados a la perfección. El nuevo EASY-BOX lo tiene todo: es muy simple y el concepto de fijación FAST-FIX hace que su instalación sea extremadamente flexible. Triple nivel de seguridad con el DICHT-FIX que evita fugas y consigue así una estanqueidad óptima de las paredes. Está disponible para mezcladores monomando y termostáticos. Cumple con la normativa DIN 4109 (insonorización) y por supuesto, con el estándar de clase I en cuanto a ruidos.

DICHT-FIX – 100% estanco

El sistema DICHT-FIX ya probado ha sido mejorado y ahora proporciona una estanqueidad triple para las unidades empotradas.

Estanqueidad externa – protección contra salpicaduras: la sujeción de la base protege al EASY-BOX de salpicaduras desde el exterior. Todas las aperturas están selladas por separado y de forma segura.

Estanqueidad interna impermeable: las juntas adicionales alrededor de los tubos salientes evitan que el agua salga del EASY-BOX hacia la pared.

Solución inteligente – juntas adaptadas: el soporte de la base se fabrica siguiendo un proceso de forjado de 2 componentes. **Sellado de estructuras:** lo más importante es asegurar que las paredes queden protegidas en cuanto a humedad y fugas para que durante la ducha el agua no penetre en la pared.

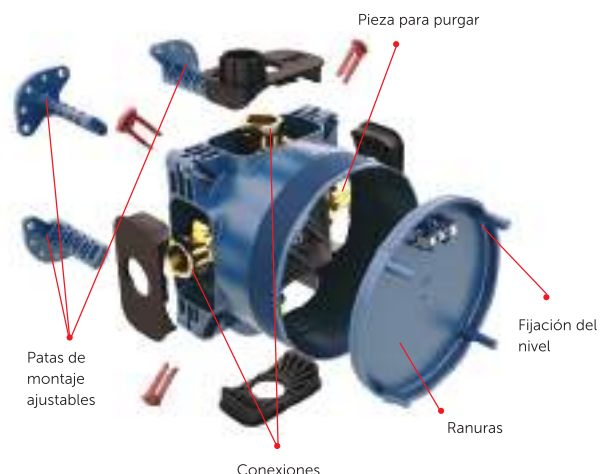

100% DE
SEGURIDAD EN
EL BAÑO CON
LA TECNOLOGÍA
COOL BODY DE
IDEAL STANDARD



INNOVACIONES FUNCIONALES

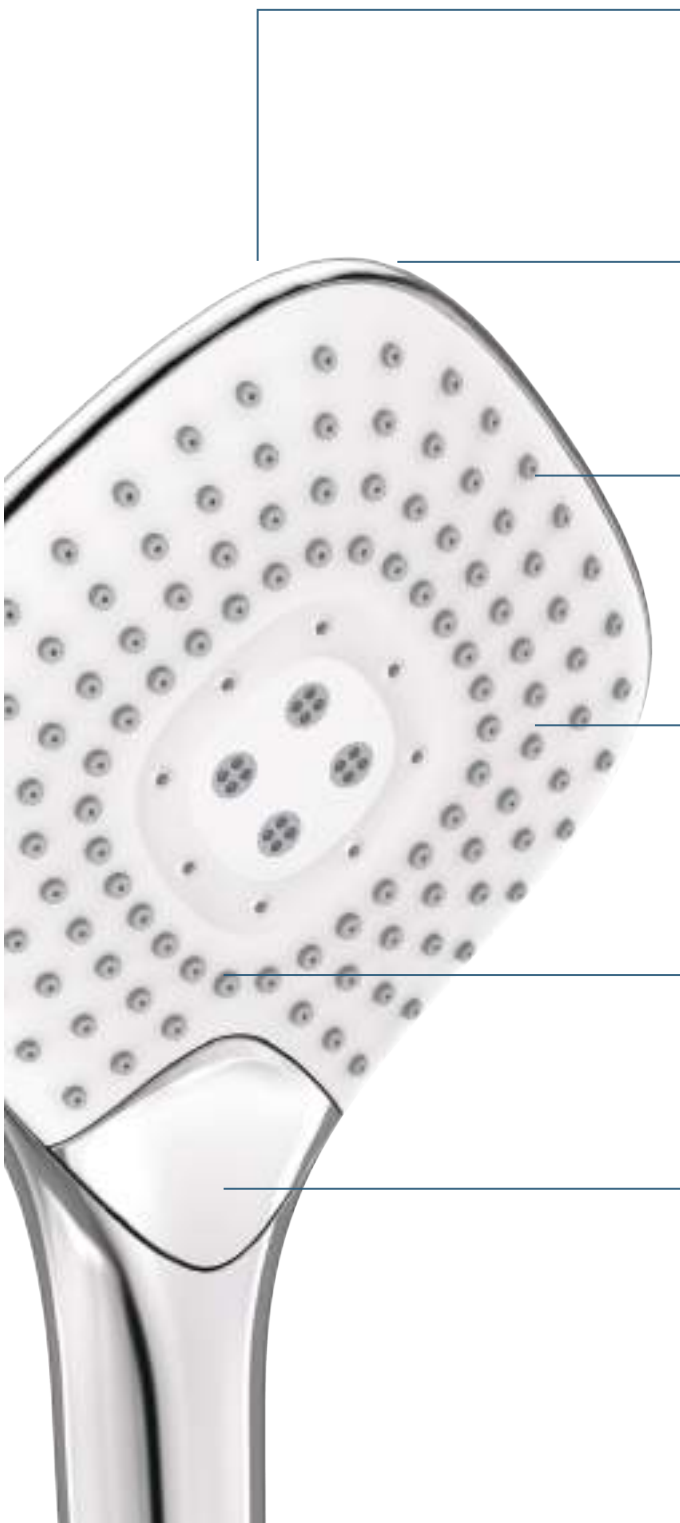

ELEGANCIA QUE DURA

IDEALRAIN EVO y IDEALRAIN EVO JET están fabricados para durar, por lo que ofrecerá un alto rendimiento durante más tiempo, incluso con un uso intensivo.

FABRICADO PARA SER EFICIENTE

Las funciones de ahorro de agua y de energía ayudan a los clientes a reducir las facturas y a cumplir con los objetivos de sostenibilidad.

TECNOLOGÍA EN ESTADO PURO

Desde el motor de flujo de alta tecnología hasta el rociador de cuerpo frío, IDEALRAIN EVO y IDEALRAIN EVO JET combina el confort con el rendimiento.

LIMPIEZA MÁS RÁPIDA

Resistente a las acumulaciones de cal. Mucho más fácil y rápido de limpiar por lo que supone un ahorro adicional para los usuarios.

DISEÑO PARA OFRECER EL MÁXIMO CONFORT

El flujo de agua generoso y los diversos modos de rociado proporcionan una experiencia excepcional en la ducha.

NAVIGO

El botón **Navigo** te permite seleccionar el mejor rociado para disfrutar de la mejor experiencia de ducha con tan sólo pulsarlo.

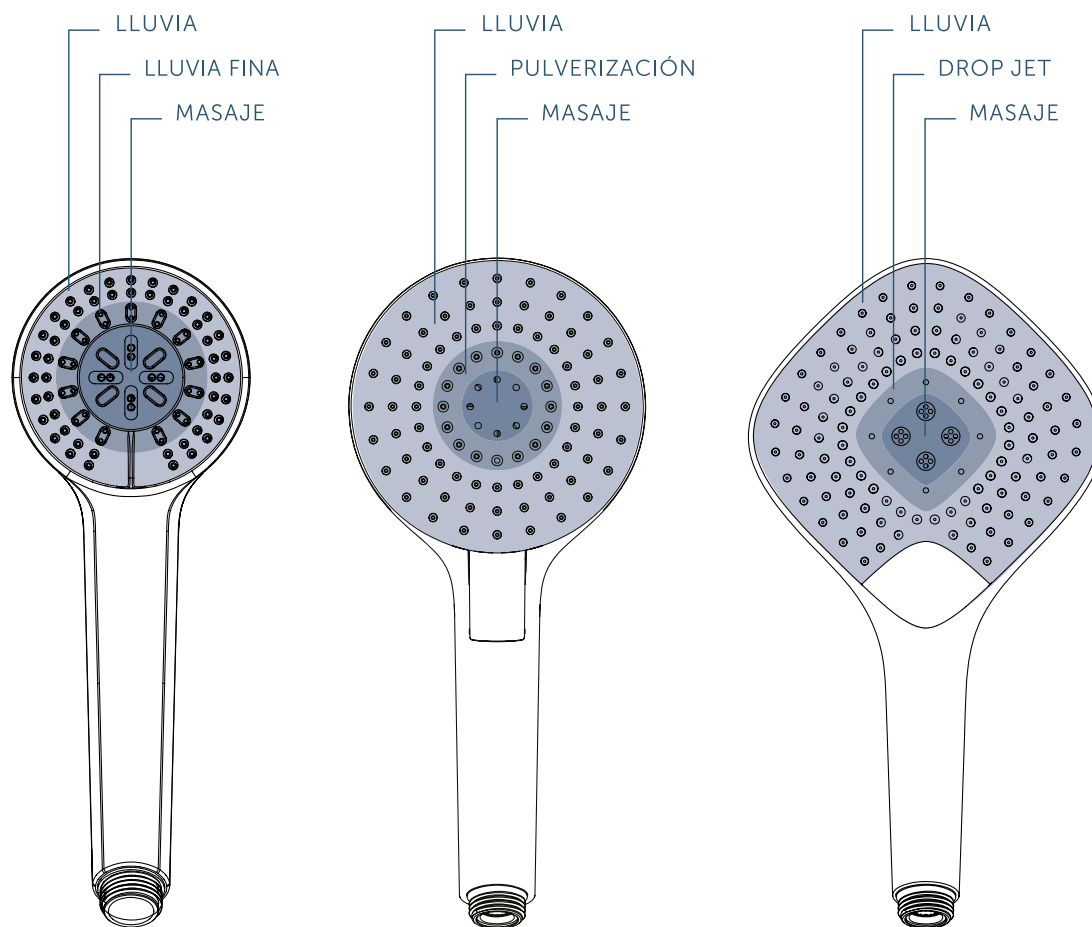

IDEALRAIN

EVO

EVO JET



GRIFERÍA

INFORMACIÓN TÉCNICA

























Sin ella, nuestros baños no estarían completos. Diseño minimalista, formas geométricas, clásicos, atemporáneos o de líneas naturales.

Te damos la bienvenida a una gran selección de grifería para escoger aquella que mejor se adapta a tu estilo.



IDEAL STANDARD

GRIFERÍA

	PICCOLO	NORMAL	GRANDE	CAÑO ALTO	SOBRE ENCIMERA
TONIC II	 200 €/Ud. Pág. 32	 230 €/Ud. Pág. 32		 260 €/Ud. Pág. 32	 320 €/Ud. Pág. 33
EDGE NOVEDAD	 145 €/Ud. Pág. 40	 155 €/Ud. Pág. 40	 165 €/Ud. Pág. 41	 275 €/Ud. Pág. 42	 275 €/Ud. Pág. 42
CONNECT AIR	 125 €/Ud. Pág. 52	 135 €/Ud. Pág. 52	 145 €/Ud. Pág. 53	 215 €/Ud. Pág. 54	 225 €/Ud. Pág. 54
TESI-CERAMIX		 125 €/Ud. Pág. 62	 125 €/Ud. Pág. 62	 180 €/Ud. Pág. 63	 175 €/Ud. Pág. 63
CERAPLAN III		 90 €/Ud. Pág. 70	 100 €/Ud. Pág. 70		
CERALINE NOVEDAD		 80 €/Ud. Pág. 78			
CERAFLEX	 70 €/Ud. Pág. 84	 85 €/Ud. Pág. 84		 115 €/Ud. Pág. 85	

GRIFERÍA TRADICIONAL

A PARED

300 €/Ud.
Pág. 33

BIDÉ

240 €/Ud.
Pág. 34BAÑO/DUCHA
EXTERIOR320 €/Ud.
Pág. 34DUCHA
EXTERIOR260 €/Ud.
Pág. 34BAÑO/DUCHA
EMPOTRADO149 €/Ud.
Pág. 34DUCHA
EMPOTRADO109 €/Ud.
Pág. 48265 €/Ud.
Pág. 43165 €/Ud.
Pág. 43220 €/Ud.
Pág. 43185 €/Ud.
Pág. 43129 €/Ud.
Pág. 4499 €/Ud.
Pág. 44235 €/Ud.
Pág. 55140 €/Ud.
Pág. 55210 €/Ud.
Pág. 55175 €/Ud.
Pág. 56175 €/Ud.
Pág. 56119 €/Ud.
Pág. 56210 €/Ud.
Pág. 64125 €/Ud.
Pág. 64190 €/Ud.
Pág. 64130 €/Ud.
Pág. 64165 €/Ud.
Pág. 64149 €/Ud.
Pág. 65100 €/Ud.
Pág. 70140 €/Ud.
Pág. 71120 €/Ud.
Pág. 71129 €/Ud.
Pág. 71109 €/Ud.
Pág. 7190 €/Ud.
Pág. 78130 €/Ud.
Pág. 78115 €/Ud.
Pág. 78119 €/Ud.
Pág. 7999 €/Ud.
Pág. 7970 €/Ud.
Pág. 85120 €/Ud.
Pág. 86105 €/Ud.
Pág. 86109 €/Ud.
Pág. 8689 €/Ud.
Pág. 86

IDEAL STANDARD

GRIFERÍA

EXTERIORES
DUCHAEXTERIORES
BAÑO/DUCHAEMPOTRADOS
DUCHAEMPOTRADOS
BAÑO/DUCHA

TONIC II

235 €/Ud.
Pág. 93270 €/Ud.
Pág. 93CERATHERM
200240 €/Ud.
Pág. 93260 €/Ud.
Pág. 93CERATHERM
100215 €/Ud.
Pág. 92275 €/Ud.
Pág. 92CERATHERM
50175 €/Ud.
Pág. 92225 €/Ud.
Pág. 92CERATHERM
25140 €/Ud.
Pág. 92

TERMOSTÁTICAS

COLUMNAS

KITS DE DUCHA

MINI KITS DE DUCHA

TELEDUCHAS

ACCESORIOS

IDEALRAIN



345 €/Ud.
Pág. 102



55 €/Ud.
Pág. 105



32 €/Ud.
Pág. 107



15 €/Ud.
Pág. 109



20 €/Ud.
Pág. 110

IDEALRAIN EVO



100 €/Ud.
Pág. 104



70 €/Ud.
Pág. 106



45 €/Ud.
Pág. 108

IDEALRAIN EVO JET



155 €/Ud.
Pág. 104













100 €/Ud.
Pág. 106



70 €/Ud.
Pág. 108

GRIFERÍA ESPECIALIZADA

	PICCOLO	GRIFO	MEZCLADOR
CERAPLUS ELECTRÓNICAS		 375 €/Ud. Pág. 120	 425 €/Ud. Pág. 120
CERAPLUS TEMPORIZADO	 120 €/Ud. Pág. 120	 240 €/Ud. Pág. 121	 300 €/Ud. Pág. 121
	PICCOLO	NORMAL	GRANDE
CERAPLUS 2.0 PARA HOSPITALES	 95 €/Ud. Pág. 122	 150 €/Ud. Pág. 122	 170 €/Ud. Pág. 122
	DUCHA TERMOSTÁTICA	BAÑO/DUCHA TERMOSTÁTICA	DUCHA EMPOTRADO
CERAPLUS 2.0	 400 €/Ud. Pág. 125	 530 €/Ud. Pág. 124	 220 €/Ud. Pág. 125

GRIFERÍA COCINA

	GIRATORIO	ABATIBLE	EXTRAÍBLE
CERAPLAN III		 195 €/Ud. Pág. 134	 205 €/Ud. Pág. 134
CERALOOK	 115 €/Ud. Pág. 135		 210 €/Ud. Pág. 135
CERAFLEX	 100 €/Ud. Pág. 136		 140 €/Ud. Pág. 136

DUCHA
EXTERIOR



320 €/Ud.
Pág. 121

DUCHA
EMPOTRADO



260 €/Ud.
Pág. 121

PULSADOR
EMPOTRADO



250 €/Ud.
Pág. 121

A PARED



225 €/Ud.
Pág. 123

TERMOSTÁTICA
A PARED



500 €/Ud.
Pág. 126

DUCHA
EXTERIOR



140 €/Ud.
Pág. 124

BAÑO/DUCHA
EMPOTRADO



240 €/Ud.
Pág. 125

DUCHA
TERMOSTÁTICA
EMPOTRADO



480 €/Ud.
Pág. 125

BAÑO/DUCHA
TERMOSTÁTICA
EMPOTRADO



550 €/Ud.
Pág. 125

CAÑO
TUBULAR



225 €/Ud.
Pág. 134

CAÑO
ALTO



225 €/Ud.
Pág. 134

CAÑO ALTO
EXTRAÍBLE



145 €/Ud.
Pág. 135



125 €/Ud.
Pág. 136



220 €/Ud.
Pág. 136

IDEAL STANDARD

GRIFERÍA



		TONIC II	EDGE	CONNECT AIR
GRIFERÍA TRADICIONAL	CON VÁLVULA	<input checked="" type="checkbox"/>	<input checked="" type="checkbox"/>	<input checked="" type="checkbox"/>
	SIN VÁLVULA	<input checked="" type="checkbox"/>	<input checked="" type="checkbox"/>	<input checked="" type="checkbox"/>
	CON CADENILLA			
	CON BLUESTART		<input checked="" type="checkbox"/>	<input checked="" type="checkbox"/>
	5L/MIN	<input checked="" type="checkbox"/>	<input checked="" type="checkbox"/>	<input checked="" type="checkbox"/>
	EASYFIX	<input checked="" type="checkbox"/>	<input checked="" type="checkbox"/>	<input checked="" type="checkbox"/>
	LATIGUILLOS PREMONTADOS	<input checked="" type="checkbox"/>	<input checked="" type="checkbox"/>	<input checked="" type="checkbox"/>
	LIMITADOR DE TEMPERATURA	<input checked="" type="checkbox"/>	<input checked="" type="checkbox"/>	<input checked="" type="checkbox"/>
	CARTUCHO CERÁMICO	28 mm	25 mm	28 mm



		IDEALRAIN	IDEALRAIN EVO	IDEALRAIN EVO JET
DUCHAS	BOTÓN NAVIGO		<input checked="" type="checkbox"/>	<input checked="" type="checkbox"/>
	3 FUNCIONES	<input checked="" type="checkbox"/>	<input checked="" type="checkbox"/>	<input checked="" type="checkbox"/>
	1 FUNCIÓN	<input checked="" type="checkbox"/>		
	DUCHA DE MANO DIAMOND		<input checked="" type="checkbox"/>	<input checked="" type="checkbox"/>
	DUCHA DE MANO ROUND	<input checked="" type="checkbox"/>	<input checked="" type="checkbox"/>	<input checked="" type="checkbox"/>
	DIFUSORES ANTICAL	<input checked="" type="checkbox"/>	<input checked="" type="checkbox"/>	<input checked="" type="checkbox"/>



TESI- CERAMIX	CERAPLAN III	CERALINE	CERAFLEX
<input checked="" type="checkbox"/>	<input checked="" type="checkbox"/>	<input checked="" type="checkbox"/>	<input checked="" type="checkbox"/>
<input checked="" type="checkbox"/>	<input checked="" type="checkbox"/>	<input checked="" type="checkbox"/>	<input checked="" type="checkbox"/>
			<input checked="" type="checkbox"/>
<input checked="" type="checkbox"/>	<input checked="" type="checkbox"/>		<input checked="" type="checkbox"/>
<input checked="" type="checkbox"/>	<input checked="" type="checkbox"/>	<input checked="" type="checkbox"/>	<input checked="" type="checkbox"/>
<input checked="" type="checkbox"/>	<input checked="" type="checkbox"/>	<input checked="" type="checkbox"/>	<input checked="" type="checkbox"/>
<input checked="" type="checkbox"/>	<input checked="" type="checkbox"/>	<input checked="" type="checkbox"/>	<input checked="" type="checkbox"/>
<input checked="" type="checkbox"/>	<input checked="" type="checkbox"/>	<input checked="" type="checkbox"/>	<input checked="" type="checkbox"/>
28 mm	38 mm	35 mm	40 mm

IDEAL STANDARD

GRIFERÍA TRADICIONAL

LEYENDA DE ICONOS



Bluestart



Ahorro de energía



Limitador de caudal



Flexible incorporado



Limitador temperatura



Easy Fix



Ahorro de agua



GRIFERÍA TONIC II

Estilo sobrio de líneas y ángulos rectos que en armonía con las formas geométricas dan como resultado piezas singulares.







INFORMACIÓN TÉCNICA

TONIC II

Estilo innovador que apuesta por las líneas y ángulos rectos sorprendentemente coherentes en cuanto a diseño y funcionalidad.

GRIFERÍA

LAVABO
PICCOLOLAVABO
NORMALLAVABO
CAÑO ALTOLAVABO
SOBRE ENCIMERA

BIDÉ

BAÑO Y DUCHA
EXTERIORBAÑO Y DUCHA
EMPOTRADO

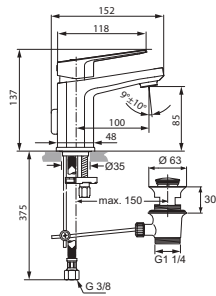

MONOMANDO LAVABO PICCOLO

Acabado: Cromo Brillo	Ref.	€/Ud.	Stock	Cant.
Caudal 5L/min con válvula	A6330AA	210		6

- Cartucho cerámico de 28mm con limitador de temperatura
- Aireador M24x1 con limitador de caudal 5L/min
- Easy Fix
- Latiguillos flexibles 3/8"
- Válvula desagüe metálica con apertura mediante varilla posterior

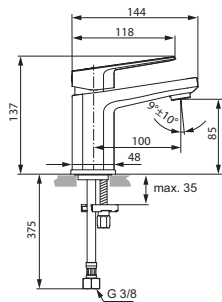

MONOMANDO LAVABO PICCOLO

Acabado: Cromo Brillo	Ref.	€/Ud.	Stock	Cant.
Caudal 5L/min sin válvula	A6331AA	200		6

- Cartucho cerámico de 28mm con limitador de temperatura
- Aireador M24x1 con limitador de caudal 5L/min
- Easy Fix
- Latiguillos flexibles 3/8"
- Cuerpo Liso

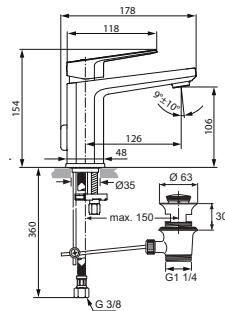

MONOMANDO LAVABO NORMAL

Acabado: Cromo Brillo	Ref.	€/Ud.	Stock	Cant.
Caudal 5L/min con válvula	A6326AA	240	<input checked="" type="checkbox"/>	6

- Cartucho cerámico de 28mm con limitador de temperatura
- Aireador M24x1 con limitador de caudal 5L/min
- Easy Fix
- Latiguillos flexibles 3/8"
- Válvula desagüe metálica con apertura mediante varilla posterior

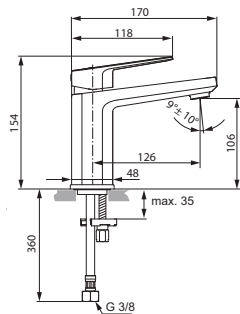

MONOMANDO LAVABO NORMAL

Acabado: Cromo Brillo	Ref.	€/Ud.	Stock	Cant.
Caudal 5L/min sin válvula	A6327AA	230	<input checked="" type="checkbox"/>	6

- Cartucho cerámico de 28mm con limitador de temperatura
- Aireador M24x1 con limitador de caudal 5L/min
- Easy Fix
- Latiguillos flexibles 3/8"
- Cuerpo Liso

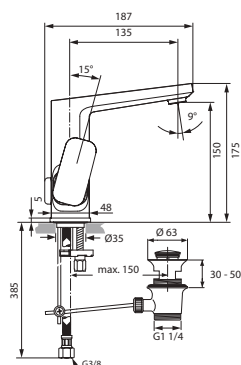

MONOMANDO LAVABO CAÑO ALTO

Acabado: Cromo Brillo	Ref.	€/Ud.	Stock	Cant.
Caudal 5L/min con válvula	A6332AA	270		6

- Cartucho cerámico de 28mm con limitador de temperatura
- Aireador M24x1 con limitador de caudal 5L/min
- Easy Fix
- Latiguillos flexibles 3/8"
- Válvula desagüe metálica con apertura mediante varilla posterior



LAVABO

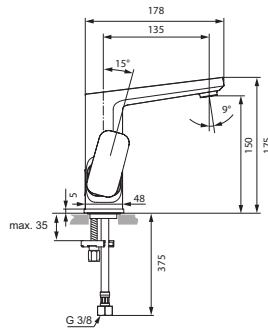

MONOMANDO LAVABO CAÑO ALTO

Acabado: Cromo Brillo	Ref.	€/Ud.	Stock	Cant.
Caudal 5L/min sin válvula	A6333AA	260		6

- Cartucho cerámico de 28mm con limitador de temperatura
- Aireador M24x1 con limitador de caudal 5L/min
- Easy Fix
- Latiguillos flexibles 3/8"
- Cuerpo Liso

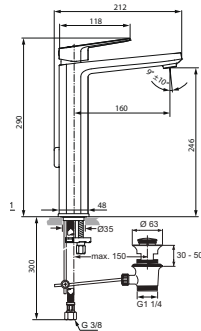

MONOMANDO LAVABO SOBRE ENCIMERA

Acabado: Cromo Brillo	Ref.	€/Ud.	Stock	Cant.
Caudal 5L/min con válvula	A6328AA	330		6

- Cartucho cerámico de 28mm con limitador de temperatura
- Aireador M24x1 con limitador de caudal 5L/min
- Easy Fix
- Latiguillos flexibles 3/8"
- Válvula desagüe metálica con apertura mediante varilla posterior

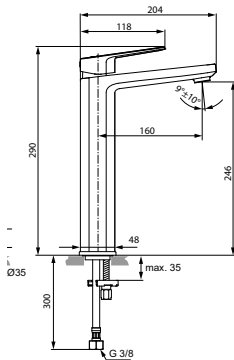

MONOMANDO LAVABO SOBRE ENCIMERA

Acabado: Cromo Brillo	Ref.	€/Ud.	Stock	Cant.
Caudal 5L/min sin válvula	A6329AA	320		6

- Cartucho cerámico de 28mm con limitador de temperatura
- Aireador M24x1 con limitador de caudal 5L/min
- Easy Fix
- Latiguillos flexibles 3/8"
- Cuerpo Liso

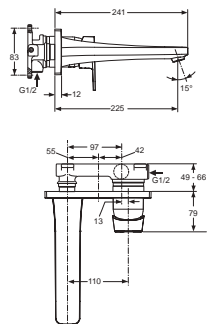

MONOMANDO LAVABO A PARED 225MM

Acabado: Cromo Brillo	Ref.	€/Ud.	Stock	Cant.
Caudal 5L/min sin válvula	A6335AA	320		6

- Cartucho cerámico de 28mm con limitador de temperatura
- Aireador M24x1 con limitador de caudal 5L/min
- Embellecedor metálico
- Cuerpo empotrado no incluido A5948NU

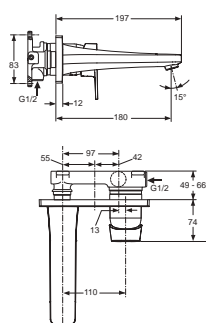

MONOMANDO LAVABO A PARED 180MM

Acabado: Cromo Brillo	Ref.	€/Ud.	Stock	Cant.
Caudal 5L/min sin válvula	A6334AA	300		6

- Cartucho cerámico de 28mm con limitador de temperatura
- Aireador M24x1 con limitador de caudal 5L/min
- Embellecedor metálico
- Cuerpo empotrado no incluido A5948NU



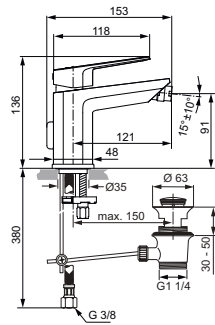

MONOMANDO BIDÉ

Acabado: Cromo Brillo	Ref.	€/Ud.	Stock	Cant.
Caudal 5l/min con válvula	A6336AA	240	<input checked="" type="checkbox"/>	6

- Cartucho cerámico de 28mm con limitador de temperatura
- Aireador M24x1 con limitador de caudal 5L/min
- Easy Fix
- Latiguillos flexibles 3/8"
- Válvula desagüe metálica con apertura mediante varilla posterior



BAÑO Y DUCHA EXTERIOR

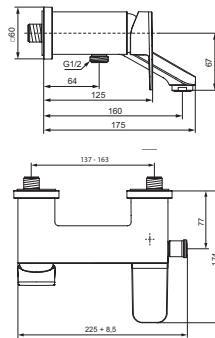

MONOMANDO BAÑO/DUCHA EXTERIOR

Acabado: Cromo Brillo	Ref.	€/Ud.	Stock	Cant.
Monomando sin accesorios	A6338AA	320	<input checked="" type="checkbox"/>	6

- Cartucho cerámico multiport de 40mm
- **Limitador de temperatura integrado**
- Embellecedores cromados ajustables
- Válvula de comprobación integrada
- Desviador automático

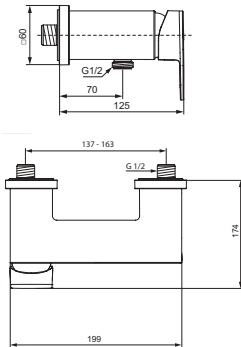

MONOMANDO DUCHA EXTERIOR

Acabado: Cromo Brillo	Ref.	€/Ud.	Stock	Cant.
Monomando sin accesorios	A6337AA	260	<input checked="" type="checkbox"/>	6

- Cartucho cerámico multiport de 40mm
- **Limitador de temperatura integrado**
- Embellecedores cromados ajustables
- Válvula de comprobación integrada



BAÑO Y DUCHA EMPOTRADO

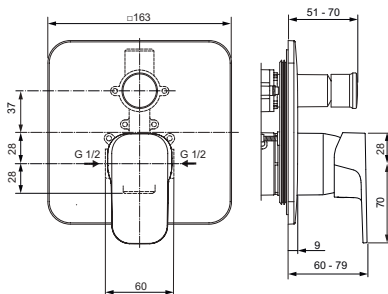

MONOMANDO BAÑO/DUCHA EMPOTRABLE

Acabado: Cromo Brillo	Ref.	€/Ud.	Stock	Cant.
Monomando Baño/Ducha Empotrable	A6343AA	149	<input checked="" type="checkbox"/>	6

- Es necesario utilizar el cuerpo empotrado A1300NU (se vende por separado)

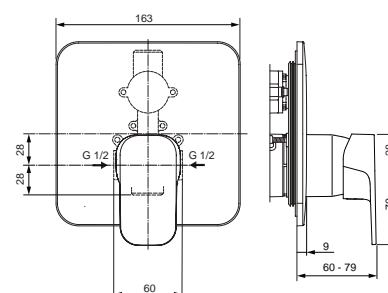

MONOMANDO DUCHA EMPOTRABLE

Acabado: Cromo Brillo	Ref.	€/Ud.	Stock	Cant.
Monomando Ducha Empotrable	A6342AA	109	<input checked="" type="checkbox"/>	6

- Es necesario utilizar el cuerpo empotrado A1300NU (se vende por separado)

CUERPO EMPOTRADO

CUERPO EMPOTRADO LAVABO A PARED

Acabado: Cromo Brillo	Ref.	€/Ud.	Stock	Cant.
Cuerpo empotrado	A5948NU	120		6

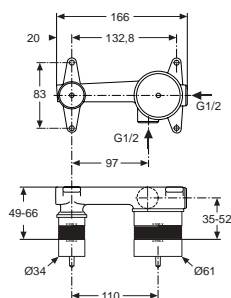

CUERPO EMPOTRADO BAÑO/DUCHA

Acabado: Cromo Brillo	Ref.	€/Ud.	Stock	Cant.
Cuerpo empotrado	A1300NU	90	<input checked="" type="checkbox"/>	6

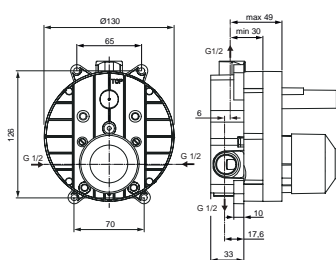

- Cartucho cerámico de 47mm CLICK TECHNOLOGY
- Con limitador de temperatura y de caudal para garantizar ahorro de agua
- Profundidad de instalación reducida



REPUESTOS TONIC II



Acabado: Neutro	Ref.	Dónde se usa	€/Ud.
Aireadores	F960876AA	A6326AA · A6327AA · A6328AA · A6329AA · A6330AA · A6331AA · A6332AA · A6333AA · A6334AA · A6335AA	15
	B964902AA	A6336AA	5
	A961132AA	A6338AA	10



Acabado: Neutro	Ref.	Dónde se usa	€/Ud.
Rótula bidé	A960019AA	A6336AA	19



Acabado: Neutro	Ref.	Dónde se usa	€/Ud.
Manetas	A860890AA	A6330AA · A6331AA · A6326AA · A6327AA · A6328AA · A6329AA · A6336AA	27
	A860894AA	A6332AA · A6333AA	15
	A860896AA	A6334AA · A6335AA · A6343AA · A6342AA	35
	A860925AA	A6338AA · A6337AA	35



Acabado: Neutro	Ref.	Dónde se usa	€/Ud.
Cartuchos monomando	F960855NU	A6326AA · A6327AA · A6330AA · A6331AA · A6332AA · A6333AA · A6336AA	35
	A960500NU	A6328AA · A6329AA · A6334AA · A6335AA · A6343AA · A6342AA	19
	A962716NU	A6337AA · A6338AA	43



Acabado: Neutro	Ref.	Dónde se usa	€/Ud.
Kit Easy-Fix	A964520NU	A6326AA · A6327AA · A6328AA · A6329AA · A6330AA · A6331AA · A6332AA · A6333AA	5



Acabado: Neutro	Ref.	Dónde se usa	€/Ud.
Válvula automática	A961230AA	A6326AA · A6328AA · A6330AA · A6332AA	26
	A962991AA	A6336AA	26

GRIFERÍA **NOVEDAD**

EDGE

Estilo sobrio de líneas y ángulos rectos creado para destacar en todos los sentidos. Con un sutil equilibrio entre simpleza, practicidad y armonía estética brinda un rendimiento superior.







INFORMACIÓN TÉCNICA **NOVEDAD**

EDGE

Esencia minimalista que apuesta por un diseño de líneas leves, sutiles y elegantes. Una propuesta de lujo para los más detallistas.

GRIFERÍA

LAVABO
PICCOLOLAVABO
NORMALLAVABO
GRANDELAVABO
CAÑO ALTOLAVABO
SOBRE ENCIMERA

BIDÉ

BAÑO Y DUCHA
EXTERIORDUCHA
EXTERIORBAÑO Y DUCHA
EMPOTRADODUCHA
EMPOTRADO

GRIFERÍA NOVEDAD EDGE

LAVABO

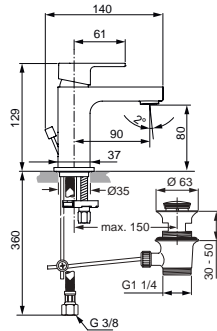

MONOMANDO LAVABO PICCOLO

Acabado: Cromo Brillo	Ref.	€/Ud.	Stock	Cant.
Caudal 5L/min con válvula	A7265AA	155		6

- **Cartucho cerámico de 25mm**
- Aireador M24x1 con limitador de caudal 5L/min
- Easy Fix
- Latiguillos flexibles 3/8"
- Válvula desagüe metálica con apertura mediante varilla posterior

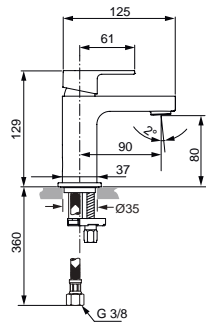

MONOMANDO LAVABO PICCOLO

Acabado: Cromo Brillo	Ref.	€/Ud.	Stock	Cant.
Caudal 5L/min sin válvula	A7266AA	145		6

- **Cartucho cerámico de 25mm**
- Aireador M24x1 con limitador de caudal 5L/min
- Easy Fix
- Latiguillos flexibles 3/8"
- Cuerpo liso

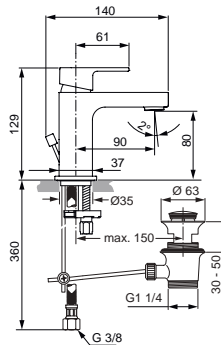

MONOMANDO LAVABO PICCOLO BLUESTART

Acabado: Cromo Brillo	Ref.	€/Ud.	Stock	Cant.
Caudal 5L/min con válvula	A7267AA	155		6

- **Tecnología Bluestart: Apertura en frío**
- **Cartucho cerámico de 25mm**
- Aireador M24x1 con limitador de caudal 5L/min
- Easy Fix
- Latiguillos flexibles 3/8"
- Válvula desagüe metálica con apertura mediante varilla posterior

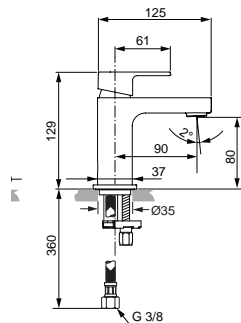

MONOMANDO LAVABO PICCOLO BLUESTART

Acabado: Cromo Brillo	Ref.	€/Ud.	Stock	Cant.
Caudal 5L/min sin válvula	A7268AA	145		6

- **Tecnología Bluestart: Apertura en frío**
- **Cartucho cerámico de 25mm**
- Aireador M24x1 con limitador de caudal 5L/min
- Easy Fix
- Latiguillos flexibles 3/8"
- Cuerpo liso

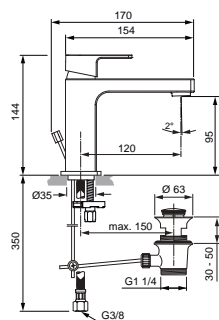

MONOMANDO LAVABO NORMAL

Acabado: Cromo Brillo	Ref.	€/Ud.	Stock	Cant.
Caudal 5L/min con válvula	A7101AA	165	<input checked="" type="checkbox"/>	6

- **Cartucho cerámico de 25mm**
- Aireador M24x1 con limitador de caudal 5L/min
- Easy Fix
- Latiguillos flexibles 3/8"
- Válvula desagüe metálica con apertura mediante varilla posterior



LAVABO

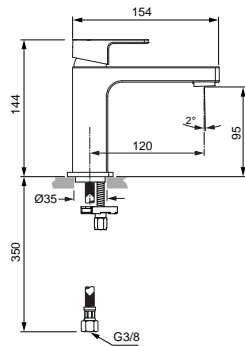

MONOMANDO LAVABO NORMAL

Acabado: Cromo Brillo	Ref.	€/Ud.	Stock	Cant.
Caudal 5L/min sin válvula	A7103AA	155	<input checked="" type="checkbox"/>	6

Cartucho cerámico de 25mm

- Aireador M24x1 con limitador de caudal 5L/min
- Easy Fix
- Latiguillos flexibles 3/8"
- Cuerpo liso

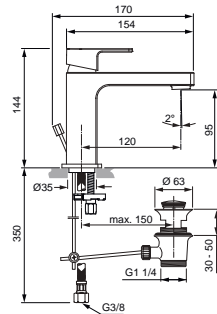

MONOMANDO LAVABO NORMAL BLUESTART

Acabado: Cromo Brillo	Ref.	€/Ud.	Stock	Cant.
Caudal 5L/min con válvula	A7102AA	165	<input checked="" type="checkbox"/>	6

Tecnología Bluestart: Apertura en frío**Cartucho cerámico de 25mm**

- Aireador M24x1 con limitador de caudal 5L/min
- Easy Fix
- Latiguillos flexibles 3/8"
- Válvula desagüe metálica con apertura mediante varilla posterior

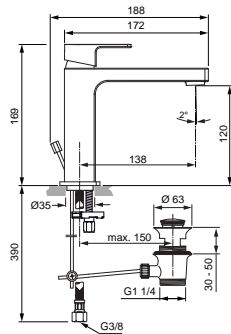

MONOMANDO LAVABO GRANDE

Acabado: Cromo Brillo	Ref.	€/Ud.	Stock	Cant.
Caudal 5L/min con válvula	A7106AA	175	<input type="checkbox"/>	6

Cartucho cerámico de 25mm

- Aireador M24x1 con limitador de caudal 5L/min
- Easy Fix
- Latiguillos flexibles 3/8"
- Válvula desagüe metálica con apertura mediante varilla posterior

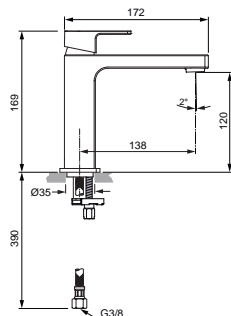

MONOMANDO LAVABO GRANDE

Acabado: Cromo Brillo	Ref.	€/Ud.	Stock	Cant.
Caudal 5L/min sin válvula	A7108AA	165	<input type="checkbox"/>	6

Cartucho cerámico de 25mm

- Aireador M24x1 con limitador de caudal 5L/min
- Easy Fix
- Latiguillos flexibles 3/8"
- Cuerpo liso

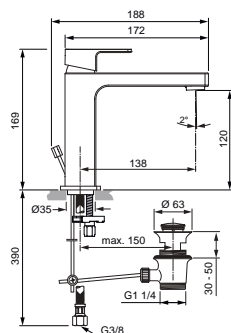

MONOMANDO LAVABO GRANDE BLUESTART

Acabado: Cromo Brillo	Ref.	€/Ud.	Stock	Cant.
Caudal 5L/min con válvula	A7107AA	175	<input type="checkbox"/>	6

Tecnología Bluestart: Apertura en frío**Cartucho cerámico de 25mm**

- Aireador M24x1 con limitador de caudal 5L/min
- Easy Fix
- Latiguillos flexibles 3/8"
- Válvula desagüe metálica con apertura mediante varilla posterior



GRIFERÍA NOVEDAD EDGE

LAVABO

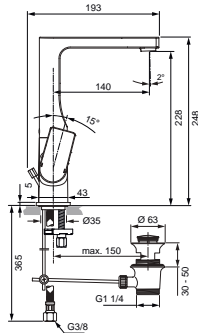

MONOMANDO LAVABO CAÑO ALTO

Acabado: Cromo Brillo	Ref.	€/Ud.	Stock	Cant.
Caudal 5L/min con válvula	A7110AA	285		6

- **Cartucho cerámico de 25mm**
- Aireador M24x1 con limitador de caudal 5L/min
- Easy Fix
- Latiguillos flexibles 3/8"
- Válvula desagüe metálica con apertura mediante varilla posterior

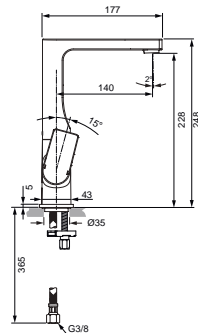

MONOMANDO LAVABO CAÑO ALTO

Acabado: Cromo Brillo	Ref.	€/Ud.	Stock	Cant.
Caudal 5L/min sin válvula	A7111AA	275		6

- **Cartucho cerámico de 25mm**
- Aireador M24x1 con limitador de caudal 5L/min
- Easy Fix
- Latiguillos flexibles 3/8"
- Cuerpo liso

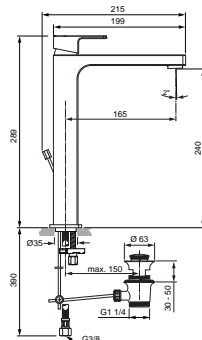

MONOMANDO LAVABO SOBRE ENCIMERA

Acabado: Cromo Brillo	Ref.	€/Ud.	Stock	Cant.
Caudal 5L/min con válvula	A7112AA	285		6

- **Cartucho cerámico de 25mm**
- Aireador M24x1 con limitador de caudal 5L/min
- Easy Fix
- Latiguillos flexibles 3/8"
- Válvula desagüe metálica con apertura mediante varilla posterior

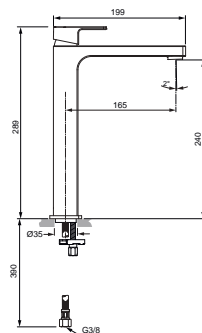

MONOMANDO LAVABO SOBRE ENCIMERA

Acabado: Cromo Brillo	Ref.	€/Ud.	Stock	Cant.
Caudal 5L/min sin válvula	A7114AA	275		6

- **Cartucho cerámico de 25mm**
- Aireador M24x1 con limitador de caudal 5L/min
- Easy Fix
- Latiguillos flexibles 3/8"
- Cuerpo liso

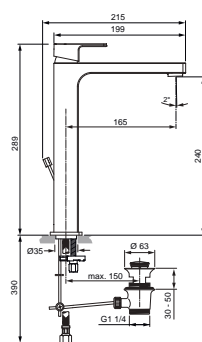

MONOMANDO LAVABO SOBRE ENCIMERA BLUESTART

Acabado: Cromo Brillo	Ref.	€/Ud.	Stock	Cant.
Caudal 5L/min con válvula	A7113AA	285		6

- **Tecnología Bluestart:** Apertura en frío
- **Cartucho cerámico de 25mm**
- Aireador M24x1 con limitador de caudal 5L/min
- Easy Fix
- Latiguillos flexibles 3/8"
- Válvula desagüe metálica con apertura mediante varilla posterior



LAVABO

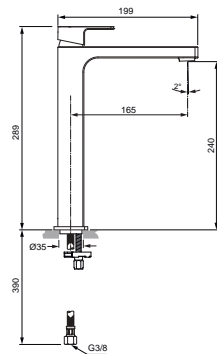

MONOMANDO LAVABO SOBRE ENCIMERA BLUESTART

Acabado: Cromo Brillo	Ref.	€/Ud.	Stock	Cant.
Caudal 5L/min sin válvula	A7115AA	275		6

- Tecnología Bluestart: Apertura en frío
- Cartucho cerámico de 25mm
- Aireador M24x1 con limitador de caudal 5L/min
- Easy Fix
- Latiguillos flexibles 3/8"
- Cuerpo liso

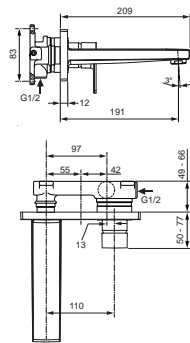

MONOMANDO LAVABO A PARED 190MM

Acabado: Cromo Brillo	Ref.	€/Ud.	Stock	Cant.
Caudal 5L/min sin válvula	A7116AA	265		6

- Cartucho cerámico de 28mm
- Aireador M24x1 con limitador de caudal 5L/min
- Cuerpo empotrado no incluido A5948NU



BIDÉ

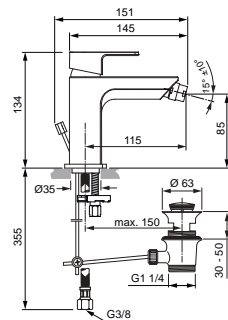

MONOMANDO BIDÉ

Acabado: Cromo Brillo	Ref.	€/Ud.	Stock	Cant.
Caudal 5L/min con válvula	A7118AA	165	<input checked="" type="checkbox"/>	6

- Cartucho cerámico de 25mm
- Easy Fix
- Latiguillos flexibles 3/8"
- Válvula desagüe metálica con apertura mediante varilla posterior



BAÑO Y DUCHA EXTERIOR

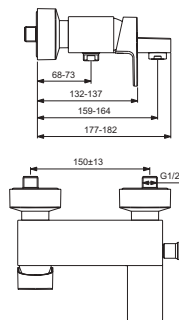

MONOMANDO BAÑO/DUCHA EXTERIOR

Acabado: Cromo Brillo	Ref.	€/Ud.	Stock	Cant.
Monomando sin accesorios	A7121AA	220	<input checked="" type="checkbox"/>	6

- Nuevo cartucho cerámico de 38mm
- Limitador de temperatura
- Desviador automático
- Conectores excéntricos con reducción de ruido
- Embelledores cuadrados

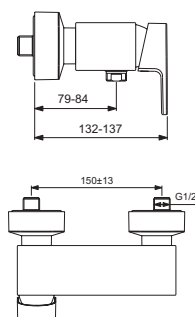

MONOMANDO DUCHA EXTERIOR

Acabado: Cromo Brillo	Ref.	€/Ud.	Stock	Cant.
Monomando sin accesorios	A7120AA	185	<input checked="" type="checkbox"/>	6

- Limitador de temperatura
- Embelledores cuadrados



GRIFERÍA NOVEDAD

EDGE

BAÑO Y DUCHA EMPOTRADO

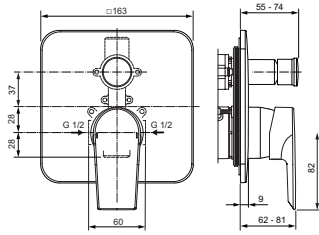

MONOMANDO BAÑO/DUCHA EMPOTRADO

Acabado: Cromo Brillo	Ref.	€/Ud.	Stock	Cant.
Monomando sin accesorios	A7127AA	129	<input checked="" type="checkbox"/>	6

· Es necesario utilizar el cuerpo empotrado A1300NU (se vende por separado)

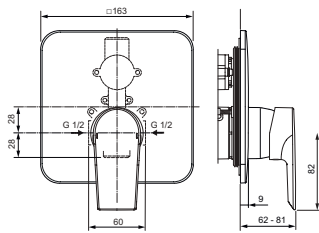

MONOMANDO DUCHA EMPOTRADO

Acabado: Cromo Brillo	Ref.	€/Ud.	Stock	Cant.
Monomando sin accesorios	A7126AA	99	<input checked="" type="checkbox"/>	6

· Es necesario utilizar el cuerpo empotrado A1300NU (se vende por separado)



CUERPO EMPOTRADO

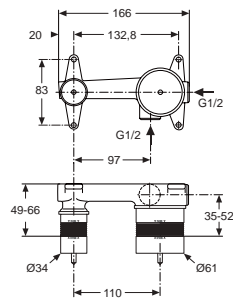

CUERPO EMPOTRADO LAVABO A PARED

Acabado: Cromo Brillo	Ref.	€/Ud.	Stock	Cant.
Cuerpo empotrado	A5948NU	120	<input checked="" type="checkbox"/>	6

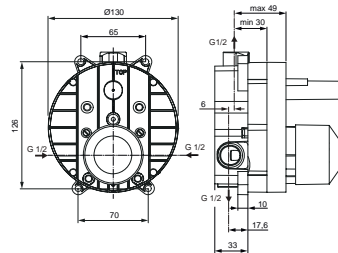

CUERPO EMPOTRADO BAÑO/DUCHA

Acabado: Cromo Brillo	Ref.	€/Ud.	Stock	Cant.
Cuerpo empotrado	A1300NU	90	<input checked="" type="checkbox"/>	6

· Cartucho cerámico de 47cm CLICK TECHNOLOGY
 · Con limitador de temperatura y de caudal para garantizar ahorro de agua
 · Profundidad de instalación reducida



REPUESTOS EDGE



Acabado: Neutro	Ref.	Dónde se usa	€/Ud.
Aireadores	A960537AA	A7121AA	5
	A963369AA	A7118AA	15
	B960754AA	A7116AA	5
	B961383AA	A7265AA · A7266AA · A7267AA · A7268AA · A7101AA A7102AA · A7103AA · A7106AA · A7107AA · A7108AA A7111AA · A7110AA · A7112AA · A7113AA · A7114AA A7115AA	5



Acabado: Neutro	Ref.	Dónde se usa	€/Ud.
Rótula bidé	A960019AA	A7118AA	19



Acabado: Neutro	Ref.	Dónde se usa	€/Ud.
Manetas	A861020AA	A7126AA · A7127AA	35
	A861294AA	A7265AA · A7266AA · A7101AA · A7103AA · A7106AA A7108AA · A7112AA · A7114AA · A7118AA	35
	A861308AA	A7267AA · A7268AA · A7102AA · A7107AA A7113AA · A7115AA	35
	A861309AA	A7111AA · A7110AA	35
	A861311AA	A7116AA	35
	B961531AA	A7120AA · A7121AA	35



Acabado: Neutro	Ref.	Dónde se usa	€/Ud.
Cartuchos monomando	A861156NU	A7120AA · A7121AA	43
	A861226NU	A7265AA · A7266AA · A7267AA · A7268AA · A7101AA A7102AA · A7103AA · A7106AA · A7107AA · A7108AA A7112AA · A7113AA · A7114AA · A7115AA · A7118AA	30
	A960500NU	A7126AA · A7127AA	19
	F960855NU	A7111AA · A7110AA	35



Acabado: Neutro	Ref.	Dónde se usa	€/Ud.
Kit Easy-Fix	A964520NU	A7265AA · A7266AA · A7268AA · A7101AA · A7102AA A7103AA · A7106AA · A7107AA · A7108AA · A7111AA A7110AA · A7112AA · A7113AA · A7114AA · A7115AA A7118AA	5



Acabado: Neutro	Ref.	Dónde se usa	€/Ud.
Válvula automática	A961230AA	A7111AA · A7110AA	26
	B960853AA	A7265AA · A7267AA · A7102AA · A7106AA A7107AA · A7112AA · A7113AA · A7118AA	20

GRIFERÍA

CONNECT AIR

De estilo moderno y atemporal, su diseño es elegante y sinuoso.





GRIFERÍA
CONNECT AIR







INFORMACIÓN TÉCNICA

CONNECT AIR

Lineas elegantes para dar forma a una estructura ligera y estilizada.

GRIFERÍA

LAVABO
PICCOLOLAVABO
NORMALLAVABO
GRANDELAVABO
CAÑO ALTOLAVABO
SOBRE ENCIMERA

BIDÉ

BAÑO Y DUCHA
EXTERIORDUCHA
EXTERIORBAÑO Y DUCHA
EMPOTRADODUCHA
EMPOTRADO

GRIFERÍA CONNECT AIR

LAVABO

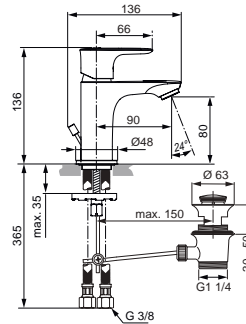

MONOMANDO LAVABO PICCOLO

Acabado: Cromo Brillo	Ref.	€/Ud.	Stock	Cant.
Caudal 5L/min con válvula	A7014AA	135		6

- **Cartucho cerámico de 25mm**
- Aireador M24x1 con limitador de caudal 5L/min
- Easy Fix
- Latiguillos flexibles 3/8"
- Válvula desagüe metálica con apertura mediante varilla posterior

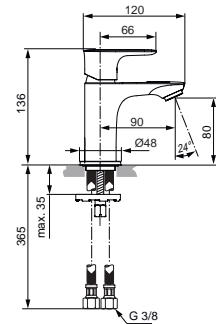

MONOMANDO LAVABO PICCOLO

Acabado: Cromo Brillo	Ref.	€/Ud.	Stock	Cant.
Caudal 5L/min sin válvula	A7018AA	125		6

- **Cartucho cerámico de 25mm**
- Aireador M24x1 con limitador de caudal 5L/min
- Easy Fix
- Latiguillos flexibles 3/8"
- Cuerpo liso

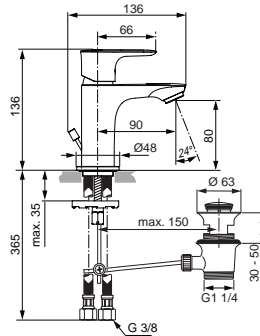

MONOMANDO LAVABO PICCOLO BLUESTART

Acabado: Cromo Brillo	Ref.	€/Ud.	Stock	Cant.
Caudal 5L/min con válvula	A7017AA	135		6

- **Tecnología Bluestart: Apertura en frío**
- **Cartucho cerámico de 25mm**
- Aireador M24x1 con limitador de caudal 5L/min
- Easy Fix
- Latiguillos flexibles 3/8"
- Válvula desagüe metálica con apertura mediante varilla posterior

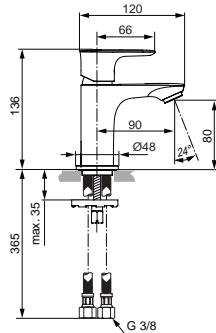

MONOMANDO LAVABO PICCOLO BLUESTART

Acabado: Cromo Brillo	Ref.	€/Ud.	Stock	Cant.
Caudal 5L/min sin válvula	A7019AA	125		6

- **Tecnología Bluestart: Apertura en frío**
- **Cartucho cerámico de 25mm**
- Aireador M24x1 con limitador de caudal 5L/min
- Easy Fix
- Latiguillos flexibles 3/8"
- Cuerpo liso

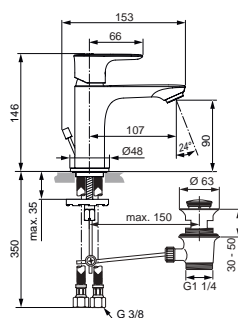

MONOMANDO LAVABO NORMAL

Acabado: Cromo Brillo	Ref.	€/Ud.	Stock	Cant.
Caudal 5L/min con válvula	A7007AA	145	<input checked="" type="checkbox"/>	6

- **Cartucho cerámico de 25mm**
- Aireador M24x1 con limitador de caudal 5L/min
- Easy Fix
- Latiguillos flexibles 3/8"
- Válvula desagüe metálica con apertura mediante varilla posterior



LAVABO

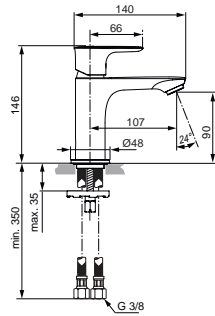

MONOMANDO LAVABO NORMAL

Acabado: Cromo Brillo	Ref.	€/Ud.	Stock	Cant.
Caudal 5L/min sin válvula	A7010AA	135	<input checked="" type="checkbox"/>	6

Cartucho cerámico de 25mm

- Aireador M24x1 con limitador de caudal 5L/min
- Easy Fix
- Latiguillos flexibles 3/8"
- Cuerpo liso

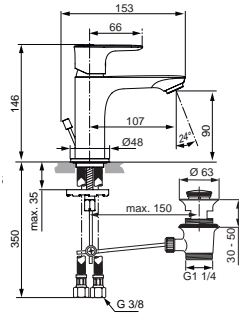

MONOMANDO LAVABO NORMAL BLUESTART

Acabado: Cromo Brillo	Ref.	€/Ud.	Stock	Cant.
Caudal 5L/min con válvula	A7008AA	145	<input checked="" type="checkbox"/>	6

Tecnología Bluestart: Apertura en frío**Cartucho cerámico de 25mm**

- Aireador M24x1 con limitador de caudal 5L/min
- Easy Fix
- Latiguillos flexibles 3/8"
- Válvula desagüe metálica con apertura mediante varilla posterior

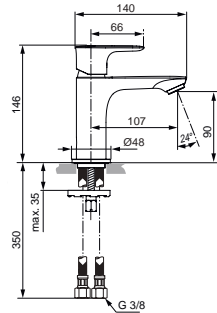

MONOMANDO LAVABO NORMAL BLUESTART

Acabado: Cromo Brillo	Ref.	€/Ud.	Stock	Cant.
Caudal 5L/min sin válvula	A7011AA	135	<input checked="" type="checkbox"/>	6

Tecnología Bluestart: Apertura en frío**Cartucho cerámico de 25mm**

- Aireador M24x1 con limitador de caudal 5L/min
- Easy Fix
- Latiguillos flexibles 3/8"
- Cuerpo liso

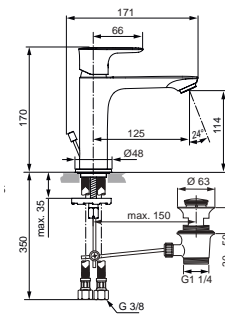

MONOMANDO LAVABO GRANDE

Acabado: Cromo Brillo	Ref.	€/Ud.	Stock	Cant.
Caudal 5L/min con válvula	A7012AA	155		6

Cartucho cerámico de 25mm

- Aireador M24x1 con limitador de caudal 5L/min
- Easy Fix
- Latiguillos flexibles 3/8"
- Válvula desagüe metálica con apertura mediante varilla posterior

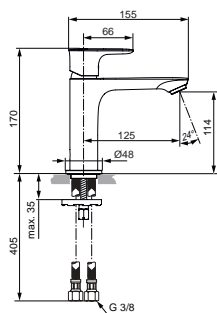

MONOMANDO LAVABO GRANDE

Acabado: Cromo Brillo	Ref.	€/Ud.	Stock	Cant.
Caudal 5L/min sin válvula	A7015AA	145		6

Cartucho cerámico de 25mm

- Aireador M24x1 con limitador de caudal 5L/min
- Easy Fix
- Latiguillos flexibles 3/8"
- Cuerpo liso



GRIFERÍA CONNECT AIR

LAVABO

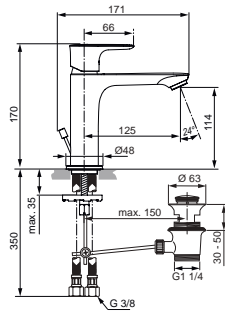

MONOMANDO LAVABO GRANDE BLUESTART

Acabado: Cromo Brillo	Ref.	€/Ud.	Stock	Cant.
Caudal 5L/min con válvula	A7013AA	155		6

- Tecnología Bluestart: Apertura en frío
- Cartucho cerámico de 25mm
- Aireador M24x1 con limitador de caudal 5L/min
- Easy Fix
- Latiguillos flexibles 3/8"
- Válvula desagüe metálica con apertura mediante varilla posterior

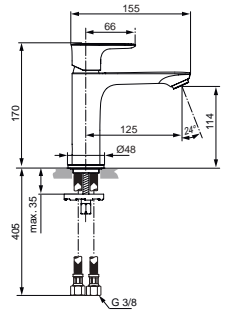

MONOMANDO LAVABO GRANDE BLUESTART

Acabado: Cromo Brillo	Ref.	€/Ud.	Stock	Cant.
Caudal 5L/min sin válvula	A7016AA	145		6

- Tecnología Bluestart: Apertura en frío
- Cartucho cerámico de 25mm
- Aireador M24x1 con limitador de caudal 5L/min
- Easy Fix
- Latiguillos flexibles 3/8"
- Cuerpo liso

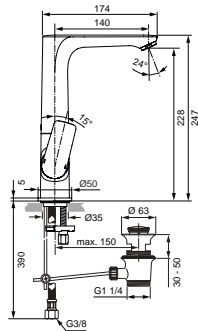

MONOMANDO LAVABO CAÑO ALTO

Acabado: Cromo Brillo	Ref.	€/Ud.	Stock	Cant.
Caudal 5L/min con válvula	A7020AA	225		6

- Cartucho cerámico de 25mm
- Aireador M24x1 con limitador de caudal 5L/min
- Easy Fix
- Latiguillos flexibles 3/8"
- Válvula desagüe metálica con apertura mediante varilla posterior

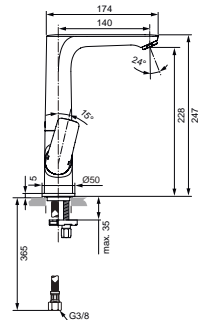

MONOMANDO LAVABO CAÑO ALTO

Acabado: Cromo Brillo	Ref.	€/Ud.	Stock	Cant.
Caudal 5L/min sin válvula	A7023AA	215		6

- Cartucho cerámico de 25mm
- Aireador M24x1 con limitador de caudal 5L/min
- Easy Fix
- Latiguillos flexibles 3/8"
- Cuerpo liso

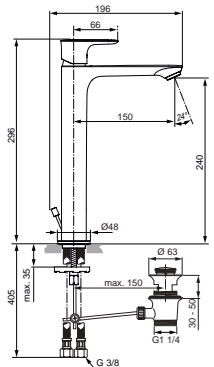

MONOMANDO LAVABO SOBRE ENCIMERA

Acabado: Cromo Brillo	Ref.	€/Ud.	Stock	Cant.
Caudal 5L/min con válvula	A7025AA	235		6

- Cartucho cerámico de 25mm
- Aireador M24x1 con limitador de caudal 5L/min
- Easy Fix
- Latiguillos flexibles 3/8"
- Válvula desagüe metálica con apertura mediante varilla posterior



LAVABO

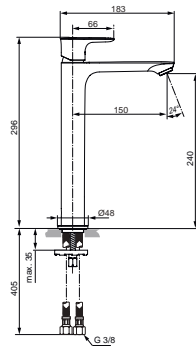

MONOMANDO LAVABO SOBRE ENCIMERA

Acabado: Cromo Brillo	Ref.	€/Ud.	Stock	Cant.
Caudal 5L/min sin válvula	A7027AA	225		6

- **Cartucho cerámico de 25mm**
- Aireador M24x1 con limitador de caudal 5L/min
- Easy Fix
- Latiguillos flexibles 3/8"
- Cuerpo liso

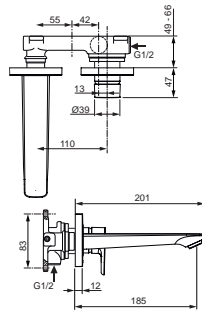

MONOMANDO LAVABO A PARED 185MM

Acabado: Cromo Brillo	Ref.	€/Ud.	Stock	Cant.
Caudal 5L/min sin válvula	A7029AA	235		6

- **Cartucho cerámico de 28mm**
- Aireador M24x1 con limitador de caudal 5L/min
- Embellecedor metálico

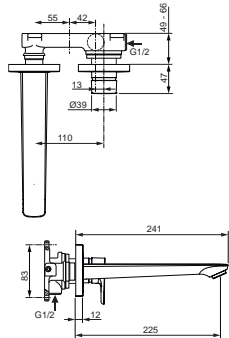

MONOMANDO LAVABO A PARED 225MM

Acabado: Cromo Brillo	Ref.	€/Ud.	Stock	Cant.
Caudal 5L/min sin válvula	A7009AA	240		6

- **Cartucho cerámico de 28mm**
- Aireador M24x1 con limitador de caudal 5L/min
- Embellecedor metálico



BIDÉ

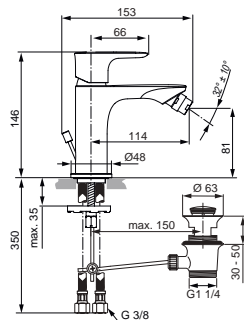

MONOMANDO BIDÉ

Acabado: Cromo Brillo	Ref.	€/Ud.	Stock	Cant.
Caudal 5L/min con válvula	A7030AA	140	<input checked="" type="checkbox"/>	6

- **Cartucho cerámico de 25mm**
- Aireador M24x1 con limitador de caudal 5L/min
- Easy Fix
- Latiguillos flexibles 3/8"
- Válvula desagüe metálica con apertura mediante varilla posterior



BAÑO Y DUCHA EXTERIOR

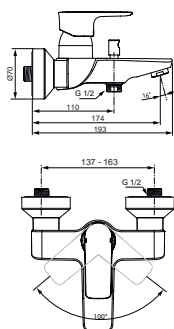

MONOMANDO BAÑO/DUCHA EXTERIOR

Acabado: Cromo Brillo	Ref.	€/Ud.	Stock	Cant.
Monomando sin accesorios	A7033AA	210	<input checked="" type="checkbox"/>	6

- **Cartucho cerámico de 38mm**
- Limitador de temperatura
- Desviador automático
- Conectores excéntricos con reducción de ruido



GRIFERÍA CONNECT AIR

BAÑO Y DUCHA EXTERIOR

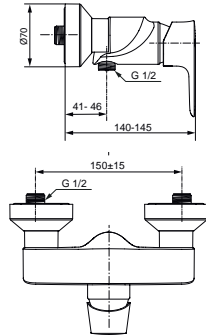

MONOMANDO DUCHA EXTERIOR

Acabado: Cromo Brillo	Ref.	€/Ud.	Stock	Cant.
Monomando sin accesorios	A7032AA	175	<input checked="" type="checkbox"/>	6

- Cartucho cerámico de 38mm
- Limitador de temperatura
- Desviador automático
- Conectores excéntricos con reducción de ruido



BAÑO Y DUCHA EMPOTRADO

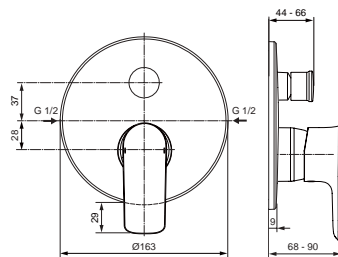

EMPOTRABLE EXTERIOR BAÑO/DUCHA

Acabado: Cromo Brillo	Ref.	€/Ud.	Stock	Cant.
Empotrable exterior baño/ ducha	A7037AA	119	<input checked="" type="checkbox"/>	6

- Es necesario utilizar el cuerpo empotrado A1300NU (se vende por separado)

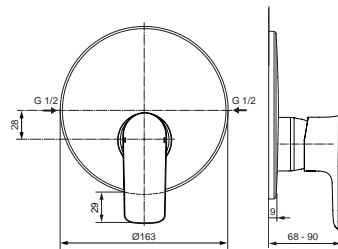

EMPOTRABLE EXTERIOR DUCHA

Acabado: Cromo Brillo	Ref.	€/Ud.	Stock	Cant.
Empotrable exterior ducha	A7036AA	89	<input checked="" type="checkbox"/>	6

- Es necesario utilizar el cuerpo empotrado A1300NU (se vende por separado)



CUERPO EMPOTRADO

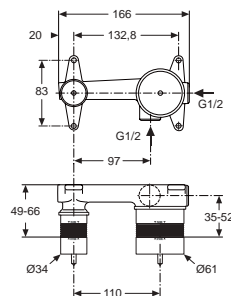

CUERPO EMPOTRADO LAVABO A PARED

Acabado: Cromo Brillo	Ref.	€/Ud.	Stock	Cant.
Cuerpo empotrado	A5948NU	120	<input type="checkbox"/>	6

CUERPO EMPOTRADO BAÑO DUCHA

Acabado: Cromo Brillo	Ref.	€/Ud.	Stock	Cant.
Cuerpo empotrado	A1300NU	90	<input checked="" type="checkbox"/>	6

- Cartucho cerámico de 47cm CLICK TECHNOLOGY
- Con limitador de temperatura y de caudal para garantizar ahorro de agua
- Profundidad de instalación reducida



REPUESTOS CONNECT AIR



Acabado: Neutro	Ref.	Dónde se usa	€/Ud.
Aireadores	B961383AA	A7007AA · A7008AA · A7010AA · A7011AA A7012AA A7013AA · A7014AA · A7015AA A7016AA · A7017AA A7018AA · A7019AA A7020AA · A7023AA · A7025AA · A7027AA	5
	A861069NU	A7009AA · A7029AA	15
	A963181NU	A7033AA · A7032AA	10
	A963369AA	A7030AA	15



Acabado: Neutro	Ref.	Dónde se usa	€/Ud.
Rótula bidé	A960019AA	A7030AA	19



Acabado: Neutro	Ref.	Dónde se usa	€/Ud.
Manetas	A861222AA	A7030AA · A7012AA · A7015AA	30
	A861228AA	A7013AA · A7016AA	30
	A861233AA	A7020AA · A7023AA · A7025AA A7027AA · A7029AA · A7009AA	30
	A861230AA	A7033AA · A7032AA	30
	A861236AA	A7037AA · A7036AA	30



Acabado: Neutro	Ref.	Dónde se usa	€/Ud.
Cartuchos monomando	A861226NU	A7030AA · A7012AA · A7015AA · A7013AA · A7016AA	30
	F960855NU	A7020AA · A7023AA	35
	A861156NU	A7033AA · A7032AA	43
	A960500NU	A7037AA · A7036AA	19



Acabado: Neutro	Ref.	Dónde se usa	€/Ud.
Kit Easy-Fix	A964520NU	A7030AA · A7012AA · A7015AA · A7013AA · A7016AA A7020AA · A7023AA · A7025AA · A7027AA	5



Acabado: Neutro	Ref.	Dónde se usa	€/Ud.
Válvula automática	B960853AA	A7012AA · A7013AA · A7025AA · A7030AA	20
	A962991AA	A7020AA	26

GRIFERÍA

TESI-CERAMIX

Cuando la naturaleza llega a tu hogar y las formas suaves y orgánicas dotan de vida a tu baño.





Lineas equilibradas y simétricas, para recrear un conjunto sencillo y elegante.





INFORMACIÓN TÉCNICA

TESI-CERAMIX

Diseño clásico pero contemporáneo,
perfectos para hacer realidad tu baño ideal.

GRIFERÍA



LAVABO
NORMAL



LAVABO
GRANDE



LAVABO
CAÑO ALTO



LAVABO
SOBRE ENCIMERA



BIDÉ



BAÑO Y DUCHA
EXTERIOR



DUCHA
EXTERIOR



BAÑO Y DUCHA
EMPOTRADO



DUCHA
EMPOTRADO

GRIFERÍA TESI-CERAMIX

LAVABO

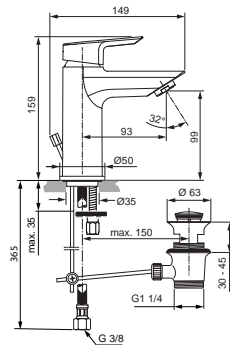

MONOMANDO LAVABO NORMAL

Acabado: Cromo Brillo	Ref.	€/Ud.	Stock	Cant.
Caudal 5L/min con válvula	A6542AA	125	<input checked="" type="checkbox"/>	6

- Cartucho cerámico de 28mm con limitador de temperatura
- Aireador M24x1 con limitador de caudal 5L/min
- Easy Fix
- Latiguillos flexibles 3/8"
- Válvula desagüe metálica con apertura mediante varilla posterior

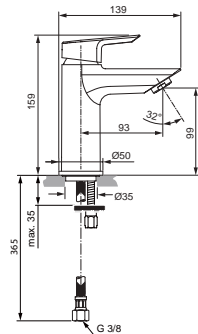

MONOMANDO LAVABO NORMAL

Acabado: Cromo Brillo	Ref.	€/Ud.	Stock	Cant.
Caudal 5L/min sin válvula	A6559AA	115	<input checked="" type="checkbox"/>	6

- Cartucho cerámico de 28mm con limitador de temperatura
- Aireador M24x1 con limitador de caudal 5L/min
- Easy Fix
- Latiguillos flexibles 3/8"
- Cuerpo Liso

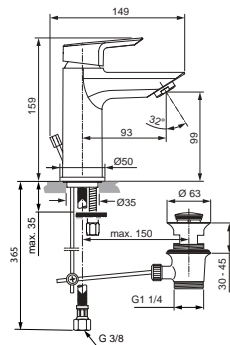

MONOMANDO LAVABO NORMAL BLUESTART

Acabado: Cromo Brillo	Ref.	€/Ud.	Stock	Cant.
Caudal 5L/min con válvula	A6543AA	125	<input checked="" type="checkbox"/>	6

- Tecnología Bluestart: Apertura en frío
- Cartucho cerámico de 28mm con limitador de temperatura
- Aireador M24x1 con limitador de caudal 5L/min
- Easy Fix
- Latiguillos flexibles 3/8"
- Válvula desagüe metálica con apertura mediante varilla posterior

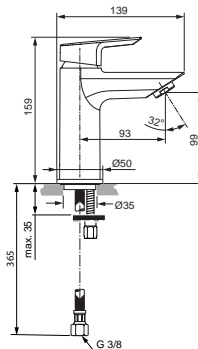

MONOMANDO LAVABO NORMAL BLUESTART

Acabado: Cromo Brillo	Ref.	€/Ud.	Stock	Cant.
Caudal 5L/min sin válvula	A6560AA	115	<input checked="" type="checkbox"/>	6

- Tecnología Bluestart: Apertura en frío
- Cartucho cerámico de 28mm con limitador de temperatura
- Aireador M24x1 con limitador de caudal 5L/min
- Easy Fix
- Latiguillos flexibles 3/8"
- Cuerpo Liso

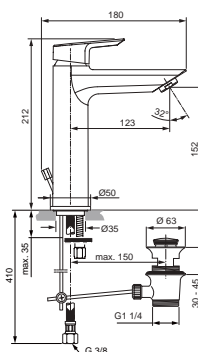

MONOMANDO LAVABO GRANDE

Acabado: Cromo Brillo	Ref.	€/Ud.	Stock	Cant.
Caudal 5L/min con válvula	A6563AA	135	<input type="checkbox"/>	6

- Cartucho cerámico de 28mm con limitador de temperatura
- Aireador M24x1 con limitador de caudal 5L/min
- Easy Fix
- Latiguillos flexibles 3/8"
- Válvula desagüe metálica con apertura mediante varilla posterior



LAVABO

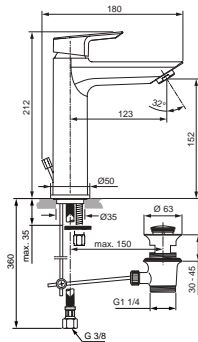

MONOMANDO LAVABO GRANDE BLUESTART

Acabado: Cromo Brillo	Ref.	€/Ud.	Stock	Cant.
Caudal 5L/min con válvula	A6564AA	135		6

- **Tecnología Bluestart:** Apertura en frío
- **Cartucho cerámico de 28mm con limitador de temperatura**
- Aireador M24x1 con limitador de caudal 5L/min
- Easy Fix
- Latiguillos flexibles 3/8"
- Válvula desagüe metálica con apertura mediante varilla posterior

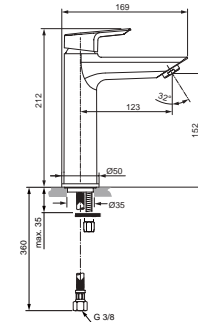

MONOMANDO LAVABO GRANDE BLUESTART

Acabado: Cromo Brillo	Ref.	€/Ud.	Stock	Cant.
Caudal 5L/min sin válvula	A6565AA	125		6

- **Tecnología Bluestart:** Apertura en frío
- **Cartucho cerámico de 28mm con limitador de temperatura**
- Aireador M24x1 con limitador de caudal 5L/min
- Easy Fix
- Latiguillos flexibles 3/8"
- Cuerpo Liso

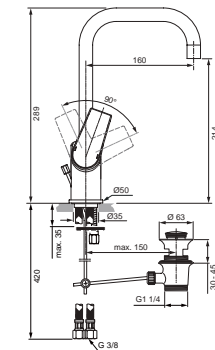

MONOMANDO LAVABO CAÑO ALTO

Acabado: Cromo Brillo	Ref.	€/Ud.	Stock	Cant.
Caudal 5L/min con válvula	A6571AA	180		6

- **Cartucho cerámico de 28mm con limitador de temperatura**
- Aireador M24x1 con limitador de caudal 5L/min
- Easy Fix
- Latiguillos flexibles 3/8"
- Válvula desagüe metálica con apertura mediante varilla posterior

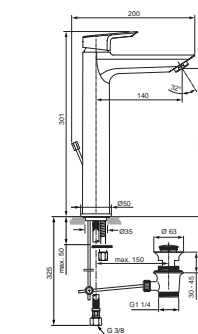

MONOMANDO LAVABO SOBRE ENCIMERA

Acabado: Cromo Brillo	Ref.	€/Ud.	Stock	Cant.
Caudal 5L/min con válvula	A6573AA	185		6

- **Cartucho cerámico de 28mm con limitador de temperatura**
- Aireador M24x1 con limitador de caudal 5L/min
- Easy Fix
- Latiguillos flexibles 3/8"
- Válvula desagüe metálica con apertura mediante varilla posterior

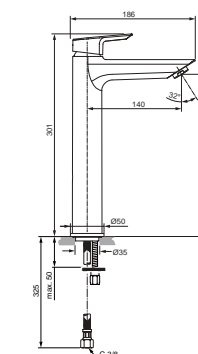

MONOMANDO LAVABO SOBRE ENCIMERA

Acabado: Cromo Brillo	Ref.	€/Ud.	Stock	Cant.
Caudal 5L/min sin válvula	A6575AA	175		6

- **Cartucho cerámico de 28mm con limitador de temperatura**
- Aireador M24x1 con limitador de caudal 5L/min
- Easy Fix
- Latiguillos flexibles 3/8"
- Cuerpo Liso



GRIFERÍA TESI-CERAMIX

LAVABO

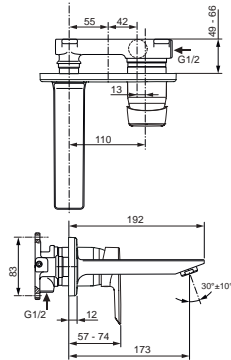

MONOMANDO LAVABO A PARED 173MM

Acabado: Cromo Brillo	Ref.	€/Ud.	Stock	Cant.
Caudal 5L/min sin válvula	A6578AA	210		6

- Cartucho cerámico de 28mm
- Aireador M24x1 con limitador de caudal 5L/min
- Embellecedor metálico
- Cuerpo empotrado no incluido A5948NU



BIDÉ

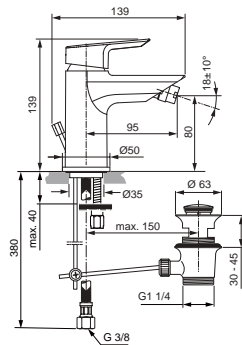

MONOMANDO BIDÉ

Acabado: Cromo Brillo	Ref.	€/Ud.	Stock	Cant.
Caudal 5L/min con válvula	A6545AA	125		6

- Cartucho cerámico de 28mm con limitador de temperatura
- Easy Fix
- Latiguillos flexibles 3/8"
- Válvula desagüe metálica con apertura mediante varilla posterior



BAÑO Y DUCHA EXTERIOR

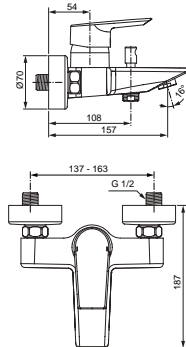

MONOMANDO BAÑO/DUCHA EXTERIOR

Acabado: Cromo Brillo	Ref.	€/Ud.	Stock	Cant.
Monomando sin accesorios	A6583AA	190		6

- Cartucho cerámico de 40mm con limitador de temperatura
- Limitador de caudal de agua
- Desviador automático

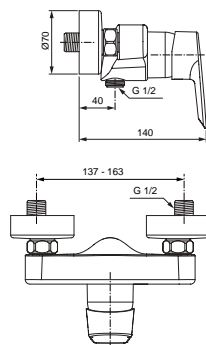

MONOMANDO DUCHA EXTERIOR

Acabado: Cromo Brillo	Ref.	€/Ud.	Stock	Cant.
Monomando sin accesorios	A6581AA	130		6

- Cartucho cerámico de 40mm
- Limitador de caudal de agua
- Desviador automático



BAÑO Y DUCHA EMPOTRADO

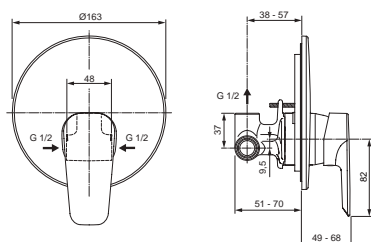

PACK MONOMANDO EMPOTRADO BAÑO/DUCHA

Acabado: Cromo Brillo	Ref.	€/Ud.	Stock	Cant.
Sin accesorios	A6549AA	165	<input checked="" type="checkbox"/>	6

- Cartucho cerámico de 47mm con limitador de temperatura
- Limitador de caudal de agua
- Cuerpo empotrado incluido en pack
- Sin accesorios de ducha



BAÑO/DUCHA EMPOTRADO

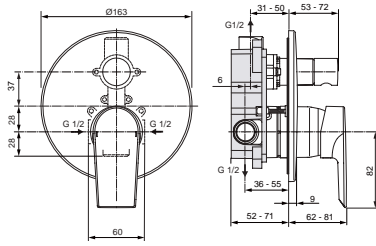

PACK MONOMANDO EMPOTRADO DUCHA

Acabado: Cromo Brillo	Ref.	€/Ud.	Stock	Cant.
Sin accesorios	A6548AA	149	<input checked="" type="checkbox"/>	6

Cartucho cerámico de 47mm con limitador de temperatura

- Limitador de caudal de agua
- Cuerpo empotrado incluido en pack
- Sin accesorios de ducha



LAVABO EMPOTRADO

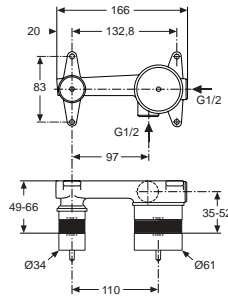

CUERPO EMPOTRADO LAVABO A PARED

Acabado: Cromo Brillo	Ref.	€/Ud.	Stock	Cant.
Cuerpo empotrado	A5948NU	120		6

Cartucho cerámico CLICK TECHNOLOGY

- Con limitador de temperatura y de caudal para garantizar ahorro de agua

REPUESTOS TESI-CERAMIX



Acabado: Neutro	Ref.	Dónde se usa	€/Ud.
Aireadores	A860050AA	A6542AA · A6559AA · A6553AA · A6545AA	10
	B960754AA	A6543AA · A6560AA · A6573AA · A6575AA	5
	F960876AA	A6578AA	15
	A963369AA	A6545AA	15
	A963181NU	A6583AA · A6581AA	10



Acabado: Neutro	Ref.	Dónde se usa	€/Ud.
Rótula bidé	A960019AA	A6545AA	19



Acabado: Neutro	Ref.	Dónde se usa	€/Ud.
Manetas	A861018AA	A6542AA · A6559AA · A6553AA · A6545AA	29
	A861023AA	A6543AA · A6560AA · A6573AA · A6575AA	35
	A861020AA	A6578AA · A6549AA · A6548AA	35
	A861019AA	A6583AA · A6581AA	35



Acabado: Neutro	Ref.	Dónde se usa	€/Ud.
Cartuchos monomando	F960855NU	A6545AA	35
	A960500NU	A6578AA · A6549AA · A6548AA	19
	B960775NU	A6583AA · A6581AA	15



Acabado: Neutro	Ref.	Dónde se usa	€/Ud.
Kit Easy-Fix	A964520NU	A6545AA · A6542AA · A6559AA · A6543AA A6560AA · A6563AA · A6564AA · A6565AA A6571AA · A6573AA · A6575AA	5



Acabado: Neutro	Ref.	Dónde se usa	€/Ud.
Válvula automática	A962991AA	A6545AA · A6542AA · A6543AA · A6563AA A6564AA · A6571AA · A6573AA	26

GRIFERÍA

CERAPLAN III

Pequeño y robusto, concentra de forma elegante todas las cualidades de un grifo de referencia.







INFORMACIÓN TÉCNICA

CERAPLAN III

Superficies planas y líneas rectas que constituyen una simetría perfecta, unión de dinamismo y simplicidad.

De cuerpo redondo, su fino "mando" se basa en una fina lámina que contrasta de forma armónica con el resto del conjunto.

GRIFERÍA

LAVABO
NORMALLAVABO
GRANDE

BIDÉ

BAÑO Y DUCHA
EXTERIORDUCHA
EXTERIORBAÑO Y DUCHA
EMPOTRADODUCHA
EMPOTRADO

GRIFERÍA CERAPLAN III

LAVABO

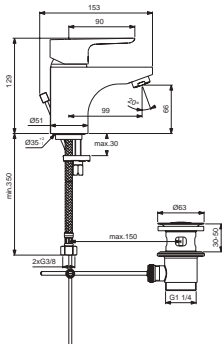

MONOMANDO LAVABO NORMAL

Acabado: Cromo Brillo	Ref.	€/Ud.	Stock	Cant.
Caudal 5L/min con válvula	B0772AA	100	<input checked="" type="checkbox"/>	6

- Nuevo cartucho cerámico de 38 mm
- Limitador de temperatura
- Aireador M24x1 con limitador de caudal 5L/min
- Easy Fix
- Latiguillos flexibles 3/8"
- Válvula desagüe metálica con apertura mediante varilla posterior

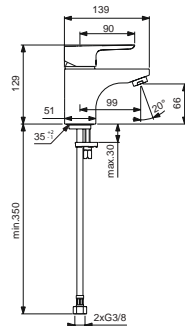

MONOMANDO LAVABO NORMAL

Acabado: Cromo Brillo	Ref.	€/Ud.	Stock	Cant.
Caudal 5L/min sin válvula	B0768AA	90	<input checked="" type="checkbox"/>	6

- Nuevo cartucho cerámico de 38 mm
- Limitador de temperatura
- Aireador M24x1 con limitador de caudal 5L/min
- Easy Fix
- Latiguillos flexibles 3/8"
- Cuerpo liso

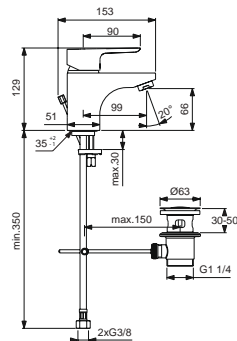

MONOMANDO LAVABO NORMAL BLUESTART

Acabado: Cromo Brillo	Ref.	€/Ud.	Stock	Cant.
Caudal 5L/min con válvula	B0767AA	100	<input checked="" type="checkbox"/>	6

- Tecnología Bluestart: Apertura en frío
- Nuevo cartucho cerámico de 38 mm
- Limitador de temperatura
- Aireador M24x1 con limitador de caudal 5L/min
- Easy Fix
- Latiguillos flexibles 3/8"
- Válvula desagüe metálica con apertura mediante varilla posterior

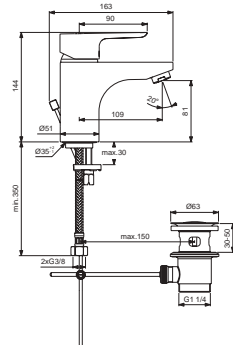

MONOMANDO LAVABO GRANDE

Acabado: Cromo Brillo	Ref.	€/Ud.	Stock	Cant.
Caudal 5L/min con válvula	B0773AA	120	<input type="checkbox"/>	6

- Nuevo cartucho cerámico de 38 mm
- Limitador de temperatura
- Aireador M24x1 con limitador de caudal 5L/min
- Easy Fix
- Latiguillos flexibles 3/8"
- Válvula desagüe metálica con apertura mediante varilla posterior

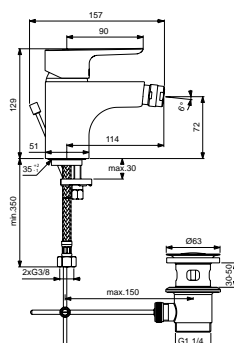

MONOMANDO BIDÉ

Acabado: Cromo Brillo	Ref.	€/Ud.	Stock	Cant.
Caudal 5L/min con válvula	B0897AA	100	<input checked="" type="checkbox"/>	6

- Nuevo cartucho cerámico de 38 mm
- Limitador de temperatura
- Aireador M24x1 con limitador de caudal 5L/min
- Easy Fix
- Latiguillos flexibles 3/8"
- Válvula desagüe metálica con apertura mediante varilla posterior



BIDÉ

BAÑO Y DUCHA EXTERIOR

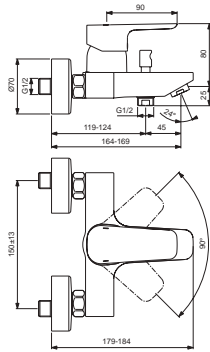

MONOMANDO BAÑO/DUCHA EXTERIOR

Acabado: Cromo Brillo	Ref.	€/Ud.	Stock	Cant.
Monomando sin accesorios	B0718AA	140	<input checked="" type="checkbox"/>	6

Cartucho cerámico de 38mm con limitador de temperatura

- Limitador de caudal y limitador de temperatura
- Válvula antirretorno integrado
- Desviador automático
- Embellecedores cromados ajustables a la
- Distancia entra 150mm a 130mm

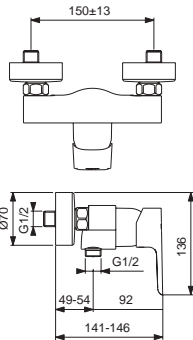

MONOMANDO DUCHA EXTERIOR

Acabado: Cromo Brillo	Ref.	€/Ud.	Stock	Cant.
Monomando sin accesorios	B0716AA	120	<input checked="" type="checkbox"/>	6

Cartucho cerámico de 38mm

- Limitador de caudal y limitador de temperatura
- Válvula antirretorno integrado
- Embellecedores cromados ajustables a la
- Distancia entra 150mm a 130mm



BAÑO Y DUCHA EMPOTRADO

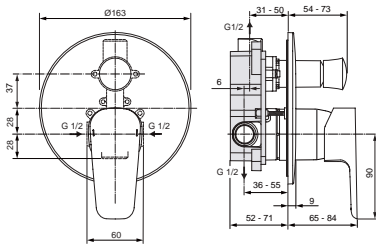

PACK MONOMANDO EMPOTRADO BAÑO/DUCHA

Acabado: Cromo Brillo	Ref.	€/Ud.	Stock	Cant.
Monomando sin accesorios	A6383AA	129	<input checked="" type="checkbox"/>	6

Cartucho cerámico de 47mm

- Limitador de temperatura
- Limitador del caudal de agua
- Desviador automático
- Nueva profundidad 52mm de instalación más reducida
- Cuerpo Empotrado A1300NU incluido

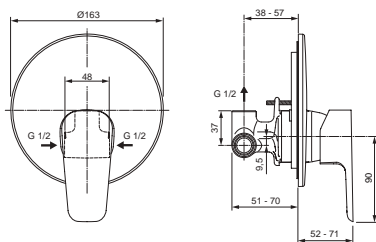

PACK MONOMANDO EMPOTRADO DUCHA

Acabado: Cromo Brillo	Ref.	€/Ud.	Stock	Cant.
Monomando sin accesorios	A6382AA	109	<input checked="" type="checkbox"/>	6

Cartucho cerámico de 47mm

- Limitador de temperatura
- Limitador del caudal de agua
- Nueva profundidad 52mm de instalación más reducida
- Cuerpo Empotrado A1300NU incluido



REPUESTOS CERAPLAN III



Acabado: Neutro	Ref.	Dónde se usa	€/Ud.
Aireadores	B960754AA	B0772AA · B0773AA	5
	A960321AA	B0768AA · B0767AA	10
	A960537AA	B0718AA · B0716AA	5



Acabado: Neutro	Ref.	Dónde se usa	€/Ud.
Manetas	B961117AA	B0772AA · B0773AA · B0897AA B0715AA · B0718AA · B0716AA	15
	B961115AA	B0768AA · B0767AA	15
	B961116AA	A6383AA · A6382AA	15



Acabado: Neutro	Ref.	Dónde se usa	€/Ud.
Cartuchos monomando	B961491NU	B0772AA · B0773AA · B0718AA B0716AA · B0768AA · B0767AA	15
	A960500NU	A6383AA · A6382AA	19



Acabado: Neutro	Ref.	Dónde se usa	€/Ud.
Kit Easy-Fix	B960608NU	B0772AA · B0773AA · B0768AA · B0767AA	5



Acabado: Neutro	Ref.	Dónde se usa	€/Ud.
Válvula automática	A962991AA	B0772AA · B0773AA · B0767AA	26



GRIFERÍA **NOVEDAD**

CERALINE

Construido sobre líneas limpias y volúmenes precisos representa la síntesis perfecta del rigor clásico y la esencialidad contemporánea.







INFORMACIÓN TÉCNICA

NOVEDAD

CERALINE

Inspirado en la forma pura del cilindro, ha sido creado para satisfacer las más diversas necesidades contemporáneas de espacio y gusto.

GRIFERÍA



LAVABO



BIDÉ

BAÑO Y DUCHA
EXTERIORDUCHA
EXTERIORBAÑO Y DUCHA
EMPOTRADODUCHA
EMPOTRADO

GRIFERÍA NOVEDAD CERALINE

LAVABO

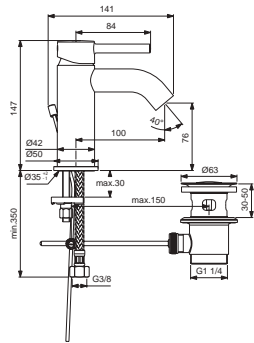

MONOMANDO LAVABO NORMAL

Acabado: Cromo Brillo	Ref.	€/Ud.	Stock	Cant.
Caudal 5L/min con válvula	BC193AA	90	<input checked="" type="checkbox"/>	6

- Cartucho Cerámico de 35mm
- Aireador con reducción de caudal a 5L/min
- Easy Fix
- Latiguillos flexibles 3/8"
- Válvula desagüe metálica con apertura mediante varilla posterior

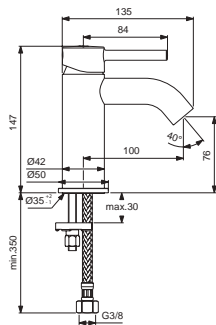

MONOMANDO LAVABO NORMAL

Acabado: Cromo Brillo	Ref.	€/Ud.	Stock	Cant.
Caudal 5L/min sin válvula	BC268AA	80	<input checked="" type="checkbox"/>	6

- Cartucho Cerámico de 35mm
- Aireador con reducción de caudal a 5L/min
- Easy Fix
- Latiguillos flexibles 3/8"
- Cuerpo liso



BIDÉ

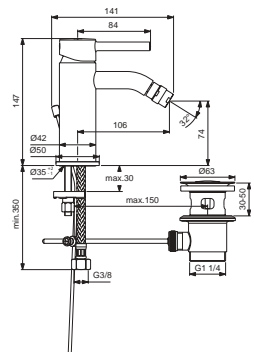

MONOMANDO BIDÉ

Acabado: Cromo Brillo	Ref.	€/Ud.	Stock	Cant.
Caudal 5L/min con válvula	BC197AA	90	<input checked="" type="checkbox"/>	6

- Cartucho Cerámico de 35mm
- Aireador con reducción de caudal a 5L/min
- Easy Fix
- Latiguillos flexibles 3/8"
- Válvula desagüe metálica con apertura mediante varilla posterior



BAÑO Y DUCHA EXTERIOR

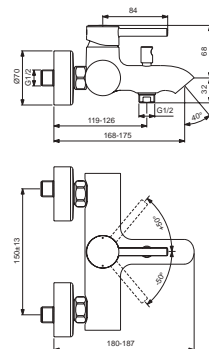

MONOMANDO BAÑO/DUCHA EXTERIOR

Acabado: Cromo Brillo	Ref.	€/Ud.	Stock	Cant.
Monomando sin accesorios	BC199AA	130	<input checked="" type="checkbox"/>	6

- Cartucho cerámico de 35mm con limitador de temperatura
- Limitador de caudal y limitador de temperatura
- Válvula antiretorno integrado
- Desviador automático
- Embellecedores cromados ajustables a la
- Distancia entra 150mm a 130mm

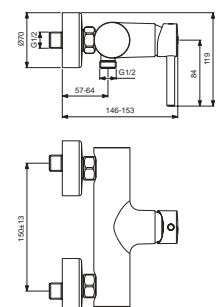

MONOMANDO DUCHA EXTERIOR

Acabado: Cromo Brillo	Ref.	€/Ud.	Stock	Cant.
Monomando sin accesorios	BC200AA	115	<input checked="" type="checkbox"/>	6

- Cartucho cerámico de 35mm con limitador de temperatura
- Limitador de caudal y limitador de temperatura
- Válvula antiretorno integrado
- Desviador automático
- Embellecedores cromados ajustables a la
- Distancia entra 150mm a 130mm



BAÑO/DUCHA EMPOTRADO

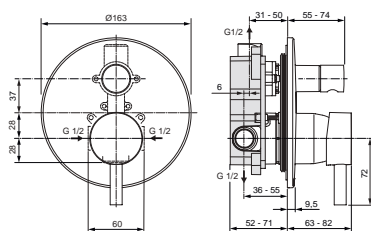

PACK MONOMANDO EMPOTRADO BAÑO/DUCHA

Acabado: Cromo Brillo	Ref.	€/Ud.	Stock	Cant.
Monomando sin accesorios	A6939AA	119	<input checked="" type="checkbox"/>	6

- Desviador automático
- Profundidad 52mm de instalación más reducida
- Cuerpo Empotrado A1300NU incluido

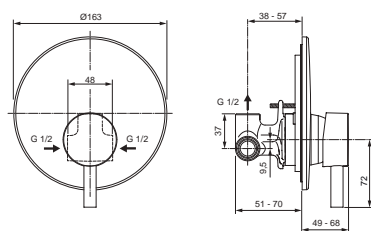

PACK MONOMANDO EMPOTRADO DUCHA

Acabado: Cromo Brillo	Ref.	€/Ud.	Stock	Cant.
Monomando sin accesorios	A6940AA	99	<input checked="" type="checkbox"/>	6

- Nueva profundidad 52mm de instalación más reducida
- Cuerpo Empotrado A1300NU incluido



REPUESTOS CERALINE



Acabado: Neutro	Ref.	Dónde se usa	€/Ud.
Aireadores	A963369AA	BC197AA	15
	B960381NU	BC199AA	10
	B960889NU	BC193AA · BC268AA	10



Acabado: Neutro	Ref.	Dónde se usa	€/Ud.
Rótula bidé	A960019AA	BC197AA	19



Acabado: Neutro	Ref.	Dónde se usa	€/Ud.
Manetas	A962397AA	A6939AA · A6940AA	15
	B961520AA	BC193AA · BC268AA · BC197AA · BC199AA · BC200AA	15



Acabado: Neutro	Ref.	Dónde se usa	€/Ud.
Cartuchos monomando	A960500NU	A6939AA · A6940AA	19
	B961476NU	BC193AA · BC268AA	19
	B961478NU	BC199AA	19
	B961480NU	BC200AA	19



Acabado: Neutro	Ref.	Dónde se usa	€/Ud.
Kit Easy-Fix	B964702NU	BC193AA · BC268AA · BC197AA	5



Acabado: Neutro	Ref.	Dónde se usa	€/Ud.
Válvula automática	A962991AA	BC193AA · BC197AA	26

GRIFERÍA CERAFLEX

Su cuerpo de formas redondas contrasta de forma armónica con su monomando plano, creando una combinación de formas original y divertida.







INFORMACIÓN TÉCNICA

CERAFLEX

Elegante juego de formas combinadas con delicadeza y suavidad.

Líneas que se funden de forma natural creando una pieza de diseño uniforme.

GRIFERÍA



LAVABO

LAVABO
GRANDE

BIDÉ

LAVABO
CAÑO ALTOBAÑO Y DUCHA
EXTERIORDUCHA
EXTERIORBAÑO Y DUCHA
EMPOTRADODUCHA
EMPOTRADO

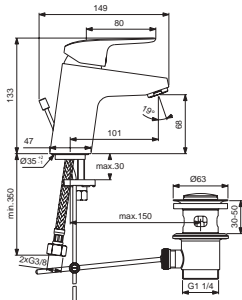

MONOMANDO LAVABO

Acabado: Cromo Brillo	Ref.	€/Ud.	Stock	Cant.
Caudal 5L/min con válvula	B1708AA	80	<input checked="" type="checkbox"/>	6

- Nuevo cartucho cerámico de 40mm con limitador de temperatura
- Aireador M24x1 con limitador de caudal 5L/min
- Easy Fix
- Latiguillos flexibles 3/8"
- Válvula desagüe metálica con apertura mediante varilla posterior

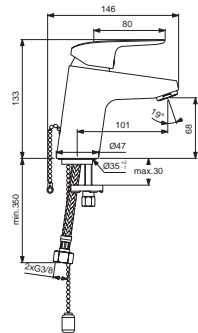

MONOMANDO LAVABO

Acabado: Cromo Brillo	Ref.	€/Ud.	Stock	Cant.
Caudal 5L/min con cadenilla	B1709AA	70	<input checked="" type="checkbox"/>	6

- Nuevo cartucho cerámico de 40mm con limitador de temperatura
- Aireador M24x1 con limitador de caudal 5L/min
- Easy Fix
- Latiguillos flexibles 3/8"
- Con cadenilla

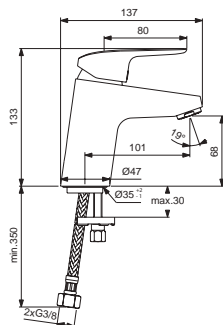

MONOMANDO LAVABO

Acabado: Cromo Brillo	Ref.	€/Ud.	Stock	Cant.
Caudal 5L/min sin válvula	B1710AA	70	<input checked="" type="checkbox"/>	6

- Nuevo cartucho cerámico de 40mm con limitador de temperatura
- Aireador M24x1 con limitador de caudal 5L/min
- Easy Fix
- Latiguillos flexibles 3/8"
- Cuerpo liso

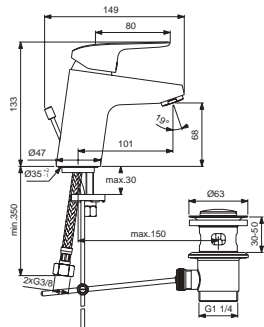

MONOMANDO LAVABO BLUESTART

Acabado: Cromo Brillo	Ref.	€/Ud.	Stock	Cant.
Caudal 5L/min con válvula	B1711AA	80	<input checked="" type="checkbox"/>	6

- Tecnología Bluestart: Apertura en frío
- Nuevo cartucho cerámico de 40mm con limitador de temperatura
- Aireador M24x1 con limitador de caudal 5L/min
- Easy Fix
- Latiguillos flexibles 3/8"
- Válvula desagüe metálica con apertura mediante varilla posterior

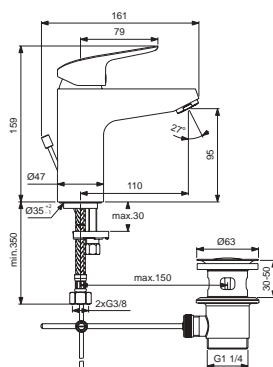

MONOMANDO LAVABO GRANDE

Acabado: Cromo Brillo	Ref.	€/Ud.	Stock	Cant.
Caudal 5L/min con válvula	B1713AA	95	<input checked="" type="checkbox"/>	6

- Nuevo cartucho cerámico de 40mm con limitador de temperatura
- Aireador M24x1 con limitador de caudal 5L/min
- Easy Fix
- Latiguillos flexibles 3/8"
- Válvula desagüe metálica con apertura mediante varilla posterior



LAVABO

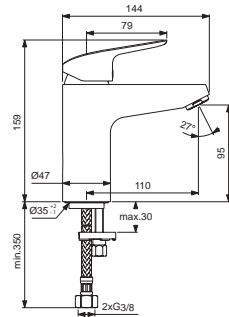

MONOMANDO LAVABO GRANDE

Acabado: Cromo Brillo	Ref.	€/Ud.	Stock	Cant.
Caudal 5L/min sin válvula	B1714AA	85		6

- Nuevo cartucho cerámico de 40mm con limitador de temperatura
- Aireador M24x1 con limitador de caudal 5L/min
- Easy Fix
- Latiguillos flexibles 3/8"
- Cuerpo liso

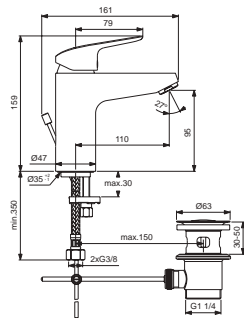

MONOMANDO LAVABO GRANDE BLUESTART

Acabado: Cromo Brillo	Ref.	€/Ud.	Stock	Cant.
Caudal 5L/min con válvula	B1715AA	95		6

- Tecnología Bluestart: Apertura en frío
- Nuevo cartucho cerámico de 40mm con limitador de temperatura
- Aireador M24x1 con limitador de caudal 5L/min
- Easy Fix
- Latiguillos flexibles 3/8"
- Válvula desagüe metálica con apertura mediante varilla posterior

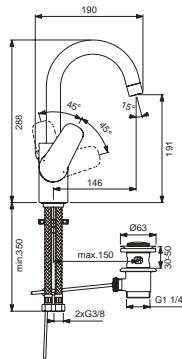

MONOMANDO LAVABO CAÑO ALTO

Acabado: Cromo Brillo	Ref.	€/Ud.	Stock	Cant.
Con válvula	B1716AA	115		6

- Nuevo cuerpo grande
- Nuevo cartucho cerámico de 40mm con limitador de temperatura
- Easy Fix
- Latiguillos flexibles 3/8"
- Válvula desagüe metálica con apertura mediante varilla posterior



BIDÉ

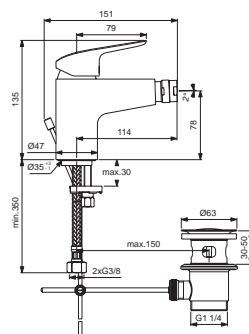

MONOMANDO BIDÉ

Acabado: Cromo Brillo	Ref.	€/Ud.	Stock	Cant.
Con válvula	B1718AA	80	<input checked="" type="checkbox"/>	6

- Nuevo cartucho cerámico de 40mm con limitador de temperatura
- Easy Fix
- Latiguillos flexibles 3/8"
- Válvula desagüe metálica con apertura mediante varilla posterior

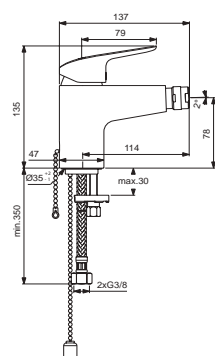

MONOMANDO BIDÉ

Acabado: Cromo Brillo	Ref.	€/Ud.	Stock	Cant.
Caudal 5L/min con cadenilla	B1825AA	70	<input checked="" type="checkbox"/>	6

- Nuevo cartucho cerámico de 40mm con limitador de temperatura
- Aireador M24x1 con limitador de caudal 5L/min
- Easy Fix
- Latiguillos flexibles 3/8"
- Con cadenilla



GRIFERÍA CERAFLEX

BAÑO Y DUCHA EXTERIOR

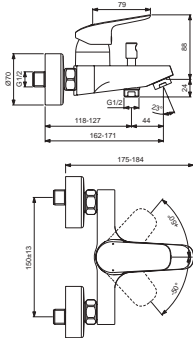

MONOMANDO BAÑO/DUCHA EXTERIOR

Acabado: Cromo Brillo	Ref.	€/Ud.	Stock	Cant.
Monomando sin accesorios	B1721AA	120	<input checked="" type="checkbox"/>	6

- **Cartucho cerámico de 40mm con Click Technology**
- Limitador de temperatura
- Limitador del caudal de agua
- Desviador automático

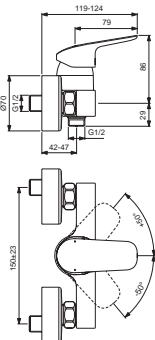

MONOMANDO DUCHA EXTERIOR

Acabado: Cromo Brillo	Ref.	€/Ud.	Stock	Cant.
Monomando sin accesorios	B1719AA	105	<input checked="" type="checkbox"/>	6

- **Cartucho cerámico de 40mm con Click Technology**
- Limitador de temperatura
- Limitador del caudal de agua



BAÑO Y DUCHA EMPOTRADO

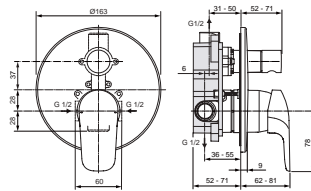

PACK MONOMANDO EMPOTRADO BAÑO/DUCHA

Acabado: Cromo Brillo	Ref.	€/Ud.	Stock	Cant.
Monomando sin accesorios	A6758AA	109	<input checked="" type="checkbox"/>	6

- **Cartucho cerámico de 47mm con limitador de temperatura**
- Limitador del caudal de agua
- Desviador automático
- Nueva profundidad 52mm de instalación más reducida
- Cuerpo Empotrado A1300NU incluido

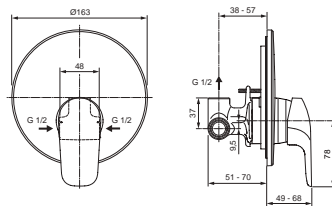







PACK MONOMANDO EMPOTRADO DUCHA

Acabado: Cromo Brillo	Ref.	€/Ud.	Stock	Cant.
Monomando sin accesorios	A6757AA	89	<input checked="" type="checkbox"/>	6

- **Cartucho cerámico de 47mm con limitador de temperatura**
- Limitador del caudal de agua
- Nueva profundidad 52mm de instalación más reducida
- Cuerpo Empotrado A1300NU incluido



REPUESTOS CERAFLEX

	Acabado: Neutro	Ref.	Dónde se usa	€/Ud.
	Aireadores	B961383AA	B1708AA · B1709AA · B1710AA · B1711AA B1713AA · B1714AA · B1715AA	5
		B960294AA	B1716AA	5
		A960321AA	B1718AA · B1825AA	10
		A960537AA	B1721AA	5
	Acabado: Neutro	Ref.	Dónde se usa	€/Ud.
	Rótula bidé	A960063AA	B1718AA · B1825AA	19
	Acabado: Neutro	Ref.	Dónde se usa	€/Ud.
	Manetas	B961375AA	B1708AA · B1709AA · B1710AA · B1713AA · B1714AA B1718AA · B1825AA · B1721AA	30
		B961377AA	B1711AA · B1715AA	15
		B961379AA	B1716AA	15
		A861131AA	A6758AA · A6757AA	15
	Acabado: Neutro	Ref.	Dónde se usa	€/Ud.
	Cartuchos monomando	A861156NU	B1708AA · B1709AA · B1710AA · B1711AA · B1713AA B1714AA · B1715AA · B1718AA · B1825AA · B1721AA B1719AA	43
		B964932NU	B1716AA	15
		A960500NU	A6758AA · A6757AA	19
	Acabado: Neutro	Ref.	Dónde se usa	€/Ud.
	Kit Easy-Fix	A964520NU	B1708AA · B1709AA · B1710AA · B1711AA · B1713AA B1714AA · B1715AA · B1718AA · B1825AA · B1721AA B1719AA	5
		B960608NU	B1716AA	5
	Acabado: Neutro	Ref.	Dónde se usa	€/Ud.
Válvula automática	A962991AA	B1708AA · B1711AA · B1716AA · B1718AA	26	

IDEAL STANDARD

TERMOSTÁTICAS

La temperatura perfecta para cada instante
a través de diseños sencillos y prácticos.

LEYENDA DE ICONOS



Limitador temperatura



Stop 40º quemadura



Ahorro de agua



Cool Body



Ahorro de energía



Tecnología Click



Easy Fix

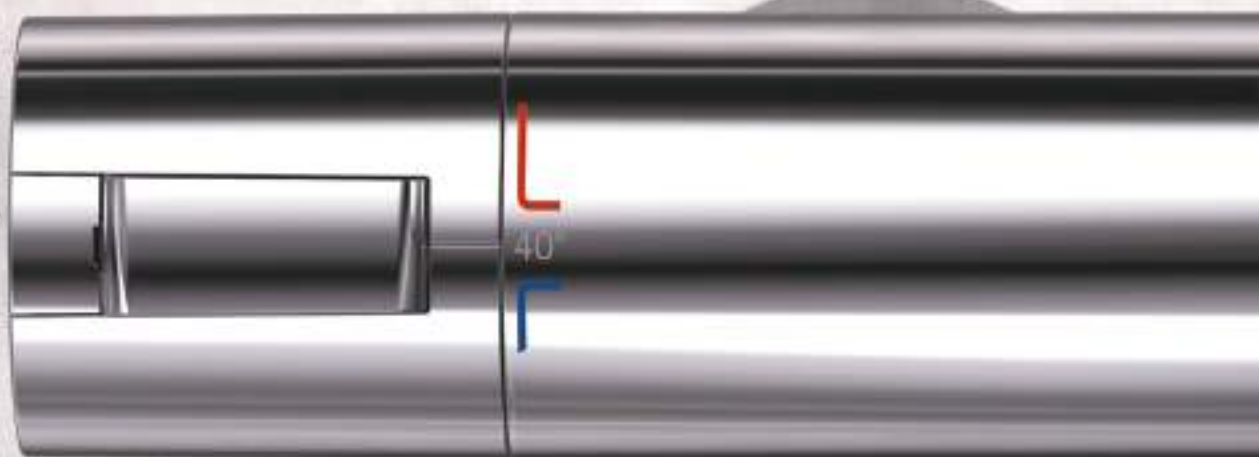



INFORMACIÓN TÉCNICA

TERMOSTÁTICAS

Porque no todos tenemos las mismas necesidades, la grifería termostática pone a nuestro alcance el agua a la temperatura ideal para cada momento, revitalizante o relajante.

GRIFERÍA



| EXTERIOR



| EMPOTRADO

| CUERPO
EMPOTRADO

GRIFERÍA TERMOSTÁTICA EXTERIOR

BAÑO Y DUCHA

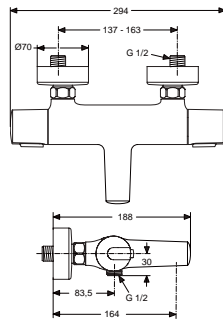

TERMOSTÁTICA EXTERIOR BAÑO/DUCHA

Acabado: Cromo Brillo	Ref.	€/Ud.	Stock	Cant.
Ceratherm 100 baño/ducha	A4623AA	275		6

· Tecnología Cool Body

- Limitador agua caliente y fría con bloqueo de seguridad
- Control de temperatura con limitador preestablecido a 40°C
- Cartucho cerámico intercambiable con rejilla anti-cal, cabezal /inversor 1/2"
- Salida de ducha 1/2" desde abajo con válvula antiretorno integrada
- Desviador integrado

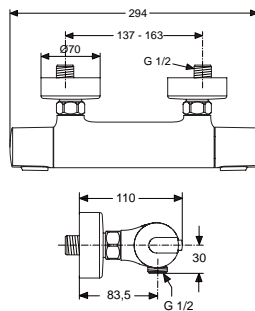

TERMOSTÁTICA EXTERIOR DUCHA

Acabado: Cromo Brillo	Ref.	€/Ud.	Stock	Cant.
Ceratherm 100 ducha	A4618AA	215		6

· Tecnología Cool Body

- Limitador agua caliente y fría con bloqueo de seguridad
- Control de temperatura con limitador preestablecido a 40°C
- Cartucho cerámico intercambiable con rejilla anti-cal, cabezal /inversor 1/2"
- Salida de ducha 1/2" desde abajo con válvula antiretorno integrada

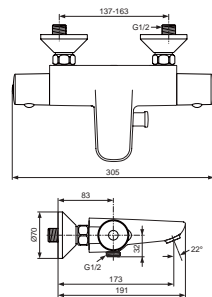

TERMOSTÁTICA EXTERIOR BAÑO/DUCHA

Acabado: Cromo Brillo	Ref.	€/Ud.	Stock	Cant.
Ceratherm 50 baño/ducha	A5550AA	225		6

· Tecnología Cool Body

- Limitador agua caliente y fría con bloqueo de seguridad
- Control de temperatura con limitador preestablecido a 40°C
- Clasificación C3: temperatura máxima de 50°
- Cartucho cerámico intercambiable con rejilla anti-cal, cabezal /inversor 1/2"
- Grifo con ahorro del 50% del caudal máximo
- Salida de ducha 1/2" desde abajo con válvula antiretorno integrada

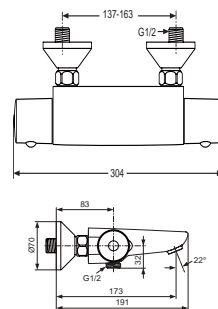

TERMOSTÁTICA EXTERIOR DUCHA

Acabado: Cromo Brillo	Ref.	€/Ud.	Stock	Cant.
Ceratherm 50 ducha	A6367AA	175		6

· Tecnología Cool Body

- Limitador agua caliente y fría con bloqueo de seguridad
- Control de temperatura con limitador preestablecido a 40°C
- Clasificación C3: temperatura máxima de 50°
- Cartucho cerámico intercambiable con rejilla anti-cal, cabezal /inversor 1/2"
- Salida de ducha 1/2" desde abajo con válvula antiretorno integrada

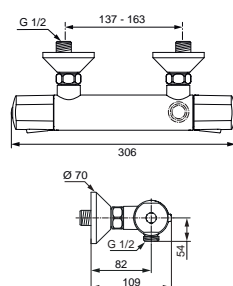

TERMOSTÁTICA EXTERIOR DUCHA

Acabado: Cromo Brillo	Ref.	€/Ud.	Stock	Cant.
Ceratherm 25 ducha	A6424AA	140		6

· Tecnología Cool Body

- Cartucho cerámico intercambiable con rejilla anti-cal, cabezal /inversor 1/2"
- Limitador agua caliente y fría con bloqueo de seguridad
- Grifo con ahorro del 50% del caudal máximo
- Válvula antiretorno
- Exéntricas regulables



TERMOSTÁTICA EMPOTRADA

BAÑO Y DUCHA

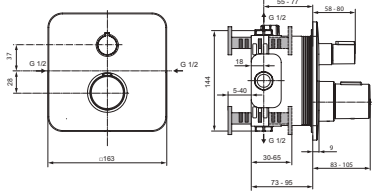

TERMOSTÁTICA EMPOTRADA BAÑO/DUCHA

Acabado: Cromo Brillo	Ref.	€/Ud.	Stock	Cant.
Tonic II baño/ducha	A6345AA	270		6

- Termostato individual para montaje a pared baño/ducha
- Válvulas laterales para llave de aislamiento
- Válvula antirretorno
- Cartucho cerámico termostático
- Sellado con SEALFIX
- EN1111 prueba de vida
- Nivel de ruido DIN 4109 grupo 1
- **Para completar con A1000NU EasyBox**

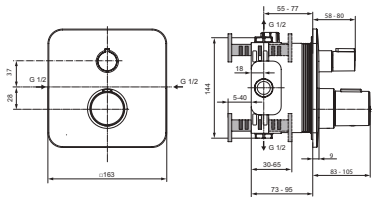

TERMOSTÁTICA EMPOTRADA DUCHA

Acabado: Cromo Brillo	Ref.	€/Ud.	Stock	Cant.
Tonic II ducha	A6344AA	235		6

- Termostato individual para montaje a pared baño/ducha
- Válvulas laterales para llave de aislamiento
- Válvula antirretorno
- Cartucho cerámico termostático
- Sellado con SEALFIX
- EN1111 prueba de vida
- Nivel de ruido DIN 4109 grupo 1
- **Para completar con A1000NU EasyBox**

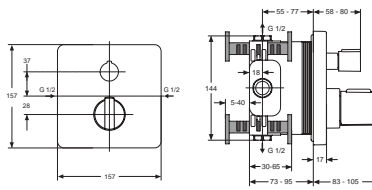

TERMOSTÁTICA EMPOTRADA BAÑO/DUCHA

Acabado: Cromo Brillo	Ref.	€/Ud.	Stock	Cant.
Ceratherm 200 baño/ducha	A5620AA	260		6

- Termostato individual para montaje a pared baño/ducha
- Válvulas laterales para llave de aislamiento
- Válvula antirretorno
- Cartucho cerámico termostático
- Sellado con SEALFIX
- EN1111 prueba de vida
- Nivel de ruido DIN 4109 grupo 1
- **Para completar con A1000NU EasyBox**

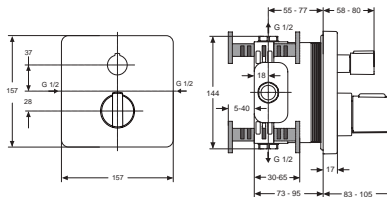

TERMOSTÁTICA EMPOTRADA DUCHA

Acabado: Cromo Brillo	Ref.	€/Ud.	Stock	Cant.
Ceratherm 200 ducha	A4662AA	240		6

- Termostato individual para montaje a pared baño/ducha
- Válvulas laterales para llave de aislamiento
- Válvula antirretorno
- Cartucho cerámico termostático
- Sellado con SEALFIX
- EN1111 prueba de vida
- Nivel de ruido DIN 4109 grupo 1
- **Para completar con A1000NU EasyBox**

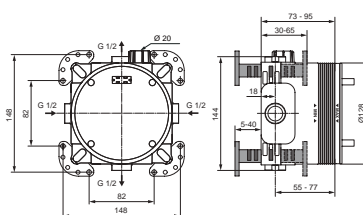

CUERPO EMPOTRADO

Acabado: Cromo Brillo	Ref.	€/Ud.	Stock	Cant.
Easybox	A1000NU	100		6

- **Sistema modular incorporado en EASY BOX**
- Sistema SEAL FIX
- Sistema FAST FIX para una instalación sencilla y rapida



GRIFERÍA REPUESTOS TERMOSTÁTICAS

CERATHERM



Acabado: Neutro	Ref.	Dónde se usa	€/Ud.
Aireadores	A960395NU	A4623AA	15
	A961132AA	A5550AA	10



Acabado: Neutro	Ref.	Dónde se usa	€/Ud.
Cartuchos termostáticos	A962229NU	A4623AA · A5550AA · A6424AA A4618AA · A6367AA	32
	A963564NU	A5620AA · A4662AA	48

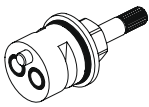

Acabado: Neutro	Ref.	Dónde se usa	€/Ud.
Cartucho caudal/inversor	A962568NU	A4623AA	40
	A963400NU	A4618AA · A5550AA · A5550AA A6367AA · A6424AA	15
	A962480NU	A5620AA	45
	A960898NU	A4662AA	25

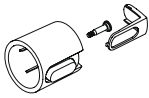

Acabado: Neutro	Ref.	Dónde se usa	€/Ud.
Maneta caudal	A962871AA	A4623AA · A4618AA	28
	A962233AA	A5550AA · A6367AA	30
	A860936AA	A6424AA	30
	A962388AA	A5620AA · A4662AA	30

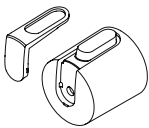

Acabado: Neutro	Ref.	Dónde se usa	€/Ud.
Maneta temperatura	A962871AA	A4623AA · A4618AA	28
	A962233AA	A5550AA · A6367AA	30
	A860936AA	A6424AA	30
	A962388AA	A5620AA · A4662AA	30

TONIC II

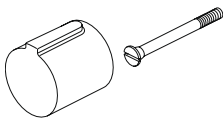

Acabado: Neutro	Ref.	Dónde se usa	€/Ud.
Maneta caudal	A962388AA	A6345AA · A6344AA	30

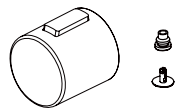

Acabado: Neutro	Ref.	Dónde se usa	€/Ud.
Maneta temperatura	A860907AA	A6345AA · A6344AA	30

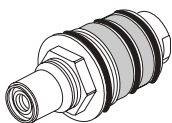

Acabado: Neutro	Ref.	Dónde se usa	€/Ud.
Cartucho termostático	A963564NU	A6345AA · A6344AA	48

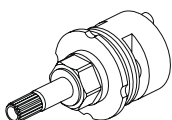

Acabado: Neutro	Ref.	Dónde se usa	€/Ud.
Cartucho caudal/inversor	A962480NU	A6345AA	45

CUERPO EMPOTRADO EASY BOX

Ideal Standard ha perfeccionado su instalación integrando la tecnología en cooperación con un grupo de expertos.

El sistema modular incorporado en EASY-BOX no deja lugar a dudas.

Gracias al sistema de montaje FAST-FIX la instalación es sencilla y flexible.

El sistema SEAL-FIX a prueba de agua ofrece una triple protección contra la misma, la penetración tanto interna como externamente, de la estanqueidad contra la humedad.

Podrá elegir entre un mezclador de una sola palanca o un termostato.

También disponible una versión de seguridad intrínseca según la norma DIN EN 1717 (protección contra la contaminación de la bebida sistemas de agua) con un dispositivo de seguridad bañera de salida. Solo es posible en combinaciones de Ideal Standard.

También cumple con la norma DIN 4109 (aislamiento acústico en los edificios de gran altura) de control de ruido normas categoría I.

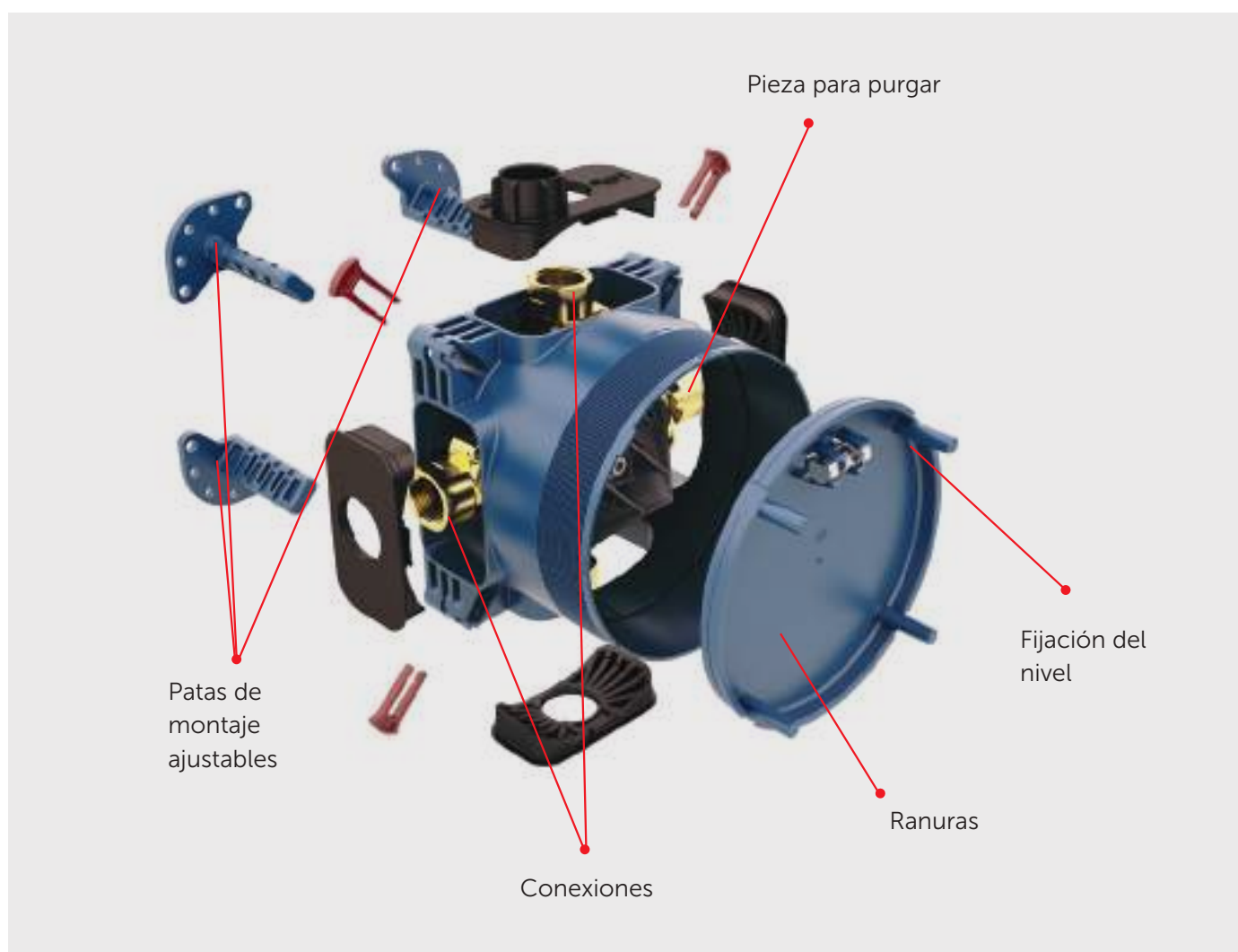

IDEAL STANDARD

DUCHAS

Relájate bajo una cascada de fina lluvia en un ambiente que mejor se adapte a tu estilo y personalidad.

LEYENDA DE ICONOS



Limitador temperatura



Tecnología Click



Ahorro de agua



Confort utilización



Ahorro de energía



Flexo antitorsión



Stop 40º quemadura



3 Funciones



Cool Body



Botón Navigo



GRIFERÍA

DUCHAS

IDEALRAIN







INFORMACIÓN TÉCNICA

DUCHAS

Estructura estilizada y diseño funcional para crear un conjunto sencillo, delicado y elegante.

Dejarse llevar por la fina lluvia de agua que cae de forma fluida y constante.

DUCHAS



COLUMNAS



KIT DE DUCHAS



MINI KIT



TELEDUCHAS



ACCESORIOS

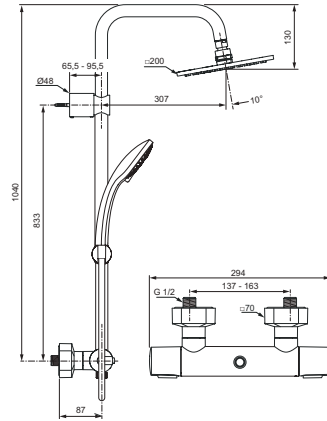

COLUMNA IDEALRAIN CUBE

Acabado: Cromo Brillo	Ref.	€/Ud.	Stock	Cant.
Ceratherm 100 3 funciones	A5833AA	480		6

Descripción columna

- **Termostática Ceratherm 100**
- Teleducha Idealrain 100mm Cube
- 3 funciones: lluvia, lluvia fina, masaje
- Rociador 200mm cubico
- Manguera de ducha Idealflex 1750mm

Descripción termoestática

- Limitador agua caliente y fría con bloqueo de seguridad
- Control de temperatura con limitador preestablecido a 40°C
- Cartucho cerámico intercambiable con rejilla anti-cal, cabezal /inversor 1/2"
- Salida de ducha 1/2" desde abajo con válvula antiretorno integrada
- **Tecnología Cool Body**

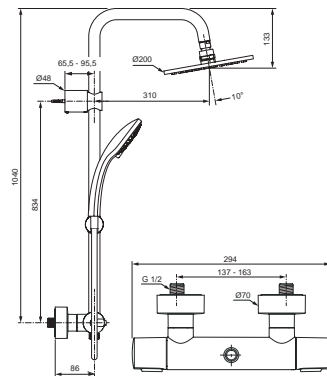

COLUMNA IDEALRAIN ROUND COLUMN

Acabado: Cromo Brillo	Ref.	€/Ud.	Stock	Cant.
Ceratherm 100 3 funciones	A5686AA	420	<input checked="" type="checkbox"/>	6

Descripción columna

- **Termostática Ceratherm 100**
- Teleducha Idealrain 100mm Round
- 3 funciones: lluvia, lluvia fina, masaje
- Rociador 200mm cubico
- Manguera de ducha Idealflex 1750mm

Descripción termoestática

- Limitador agua caliente y fría con bloqueo de seguridad
- Control de temperatura con limitador preestablecido a 40°C
- Cartucho cerámico intercambiable con rejilla anti-cal, cabezal /inversor 1/2"
- Salida de ducha 1/2" desde abajo con válvula antiretorno integrada
- **Tecnología Cool Body**



COLUMNAS

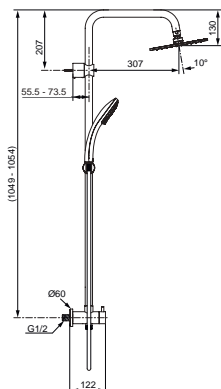

COLUMNA IDEALRAIN CUBE

Acabado: Cromo Brillo	Ref.	€/Ud.	Stock	Cant.
Instalación directa 3 Funciones	A5834AA	345		6

- Teleducha Cube 100mm
- **3 Funciones: lluvia, lluvia fina, masaje**
- Rociador orientable de 200mm
- Manguera de ducha Idealflex 1750mm

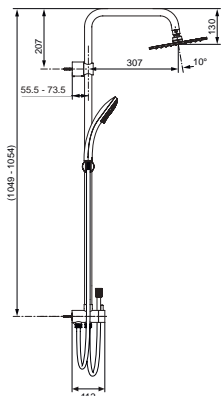

COLUMNA IDEALRAIN CUBE

Acabado: Cromo Brillo	Ref.	€/Ud.	Stock	Cant.
Instalación indirecta 3 Funciones	A5862AA	370		6

- Teleducha Cube 100mm
- **3 Funciones: lluvia, lluvia fina, masaje**
- Rociador orientable de 200mm
- Manguera de ducha Idealflex 1750mm

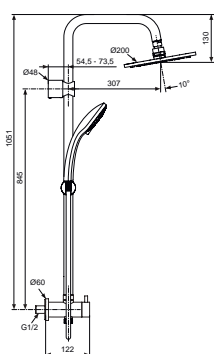

COLUMNA IDEALRAIN ROUND

Acabado: Cromo Brillo	Ref.	€/Ud.	Stock	Cant.
Instalación directa 3 Funciones	A5689AA	345		6

- Teleducha Evo Round 100mm
- **3 Funciones: lluvia, lluvia fina, masaje**
- Rociador 200mm
- Manguera de ducha Idealflex 1750mm

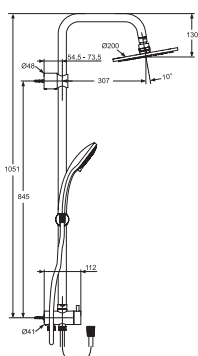

COLUMNA IDEALRAIN ROUND

Acabado: Cromo Brillo	Ref.	€/Ud.	Stock	Cant.
Instalación indirecta 3 Funciones	A5691AA	370		6

- Teleducha M3 Round 100mm
- **3 Funciones: lluvia, lluvia fina, masaje**
- Rociador 200mm
- Manguera de ducha Idealflex 1750mm



GRIFERÍA DUCHAS

KIT DE DUCHA

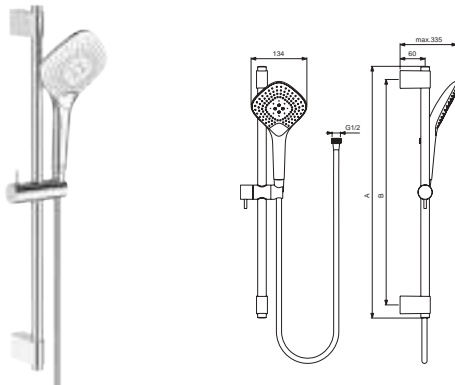

IDEALRAIN EVO JET KIT DUCHA

Acabado: Cromo Brillo	Ref.	€/Ud.	Stock	Cant.
Con barra 900mm	B1764AA	165		6
Con barra 600mm	B1762AA	155		6

- Ducha de mano Diamond
- **Botón Navigo**
- 3 funciones: Lluvia, drop-jet y masaje
- Difusores de silicona anticalcáreos
- Barra de ducha 600/900mm
- Manguera de ducha Idealflex 1750mm



	A	B
B1762AA	603	540
B1764AA	903	840

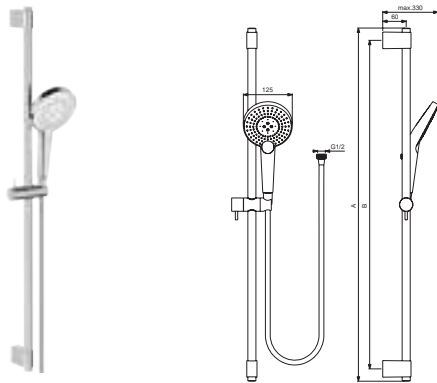

IDEALRAIN EVO JET KIT DUCHA

Acabado: Cromo Brillo	Ref.	€/Ud.	Stock	Cant.
Con barra 900mm	B1763AA	165		6
Con barra 600mm	B1761AA	155		6

- Ducha de mano Round
- **Botón Navigo**
- 3 funciones: lluvia, drop-jet y masaje
- Difusores de silicona anticalcáreos
- Barra de ducha 600/900mm
- Manguera de ducha Idealflex 1750mm



	A	B
B1761AA	603	540
B1763AA	903	840

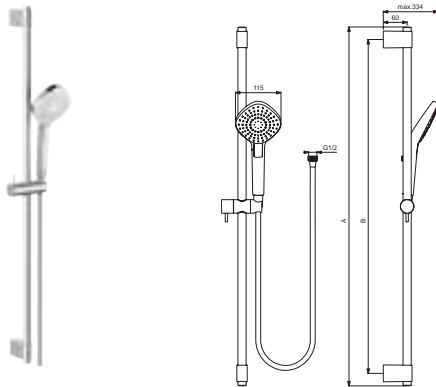

IDEALRAIN EVO KIT DUCHA

Acabado: Cromo Brillo	Ref.	€/Ud.	Stock	Cant.
Con barra 900mm	B2238AA	110		6
Con barra 600mm	B2234AA	100		6

- Ducha de mano Diamond
- **Botón Navigo**
- 3 funciones: lluvia, lluvia fina y masaje
- Difusores de silicona anticalcáreos
- Barra de ducha 600/900mm
- Manguera de ducha Idealflex 1750mm



	A	B
B2234AA	603	540
B2238AA	903	840

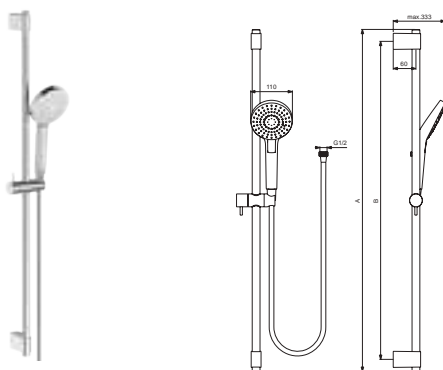

IDEALRAIN EVO KIT DUCHA

Acabado: Cromo Brillo	Ref.	€/Ud.	Stock	Cant.
Con barra 900mm	B2237AA	110		6
Con barra 600mm	B2233AA	100		6

- Ducha de mano Round
- **Botón Navigo**
- 3 funciones: lluvia, lluvia fina y masaje
- Difusores de silicona anticalcáreos
- Barra de ducha 600/900mm
- Manguera de ducha Idealflex 1750mm



	A	B
B2233AA	603	540
B2237AA	903	840

KIT DE DUCHA

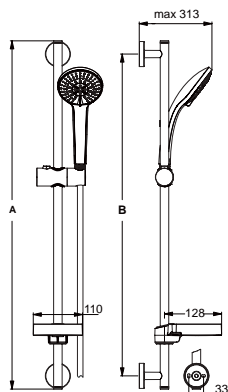

IDEALRAIN M3

Acabado: Cromo Brillo	Ref.	€/Ud.	Stock	Cant.
Con barra 900mm	B9417AA	83		6
Con barra 720mm	B9419AA	78		6
Con barra 600mm	B9415AA	73		6

- Jabonera transparente
- Ducha extraíble de ø100mm
- Difusores de silicona anticalcáreos
- **3 Funciones: lluvia, lluvia fina, masaje**
- Manguera de ducha Idealflex 1750mm



	A	B
B9417AA	909	850
B9419AA	724	675
B9415AA	609	550

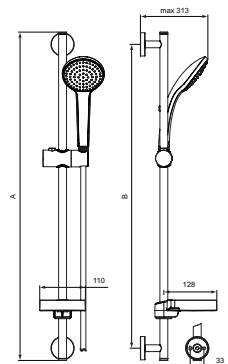

IDEALRAIN M1

Acabado: Cromo Brillo	Ref.	€/Ud.	Stock	Cant.
Con barra 900mm	B9414AA	70		6
Con barra 720mm	B9418AA	65		6
Con barra 600mm	B9412AA	60		6

- Jabonera transparente
- Ducha extraíble de ø100mm
- **1 función con difusores de silicona anticalcáreos**
- Manguera de ducha Idealflex 1750mm



	A	B
B9414AA	909	850
B9418AA	724	675
B9412AA	609	550

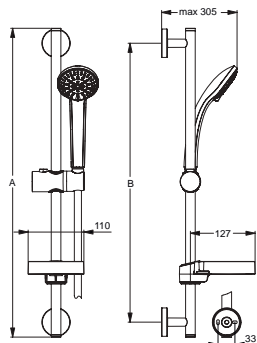

IDEALRAIN S3

Acabado: Cromo Brillo	Ref.	€/Ud.	Stock	Cant.
Con barra 900mm	B9504AA	70		6
Con barra 600mm	B9503AA	60		6

- Jabonera transparente
- Ducha extraíble de ø80mm
- Difusores de silicona anticalcáreos
- **3 Funciones: lluvia, lluvia fina, masaje**
- Manguera de ducha Idealflex 1750mm



	A	B
B9503AA	609	550
B9504AA	909	850

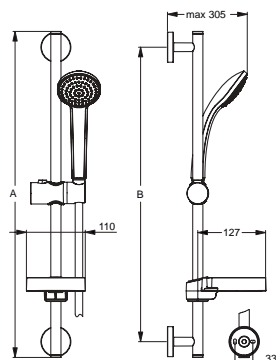

IDEALRAIN S1

Acabado: Cromo Brillo	Ref.	€/Ud.	Stock	Cant.
Con barra 900mm	B9502AA	65		6
Con barra 600mm	B9501AA	55		6

- Jabonera transparente
- Ducha extraíble de ø80mm
- **1 función con difusores de silicona anticalcáreos**
- Manguera de ducha Idealflex 1750mm



	A	B
B9501AA	609	550
B9502AA	909	850

GRIFERÍA DUCHAS

MINI KIT

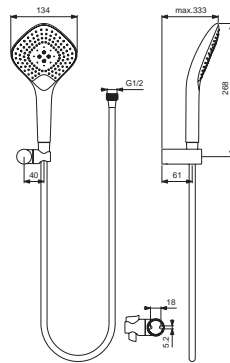

IDEALRAIN EVO JET KIT DUCHA

Acabado: Cromo Brillo	Ref.	€/Ud.	Stock	Cant.
Diamond 3 funciones	B1766AA	100		6

- Ducha de mano Diamond
- **Botón Navigo**
- 3 funciones: lluvia, drop-jet y masaje
- Difusores de silicona anticalcáreos
- Manguera de ducha Idealflex 1750mm
- Soporte a pared articulado

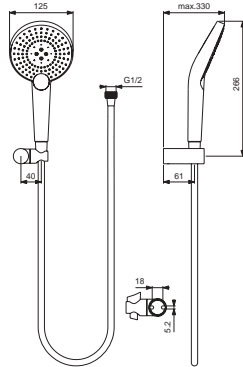

IDEALRAIN EVO JET KIT DUCHA

Acabado: Cromo Brillo	Ref.	€/Ud.	Stock	Cant.
Round 3 funciones	B1765AA	100		6

- Ducha de mano Round
- **Botón Navigo**
- 3 funciones: lluvia, drop-jet y masaje
- Difusores de silicona anticalcáreos
- Manguera de ducha Idealflex 1750mm
- Soporte a pared articulado

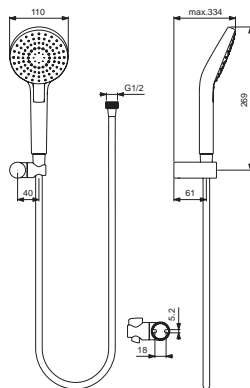

IDEALRAIN EVO KIT DUCHA

Acabado: Cromo Brillo	Ref.	€/Ud.	Stock	Cant.
Round 3 funciones	B2239AA	70		6

- Ducha de mano Round
- **Botón Navigo**
- 3 funciones: lluvia, lluvia fina y masaje
- Difusores de silicona anticalcáreos
- Manguera de ducha Idealflex 1750mm
- Soporte a pared articulado

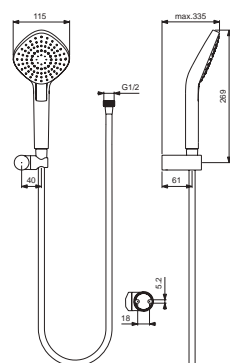

IDEALRAIN EVO KIT DUCHA

Acabado: Cromo Brillo	Ref.	€/Ud.	Stock	Cant.
Diamond 3 funciones	B2240AA	70		6

- Ducha de mano Diamond
- **Botón Navigo**
- 3 funciones: lluvia, lluvia fina y masaje
- Difusores de silicona anticalcáreos
- Manguera de ducha Idealflex 1750mm
- Soporte a pared articulado



MINI KIT



MINIKIT IDEALRAIN M3

Acabado: Cromo Brillo	Ref.	€/Ud.	Stock	Cant.
Round 3 funciones	B9454AA	49		6

- Ducha extraíble de \varnothing 100mm
- Difusores de silicona anticalcáreos
- **3 Funciones: lluvia, lluvia fina, masaje**
- Manguera de ducha Idealflex 1500mm
- Reductor de caudal 8L/min 3 bars
- Soporte a pared articulado



MINIKIT IDEALRAIN S3

Acabado: Cromo Brillo	Ref.	€/Ud.	Stock	Cant.
Round 3 funciones	B9507AA	42		6

- Ducha extraíble de \varnothing 80mm
- Difusores de silicona anticalcáreos
- **3 Funciones: lluvia, lluvia fina, masaje**
- Manguera de ducha Idealflex 1500mm
- Reductor de caudal 8L/min 3 bars
- Soporte a pared articulado

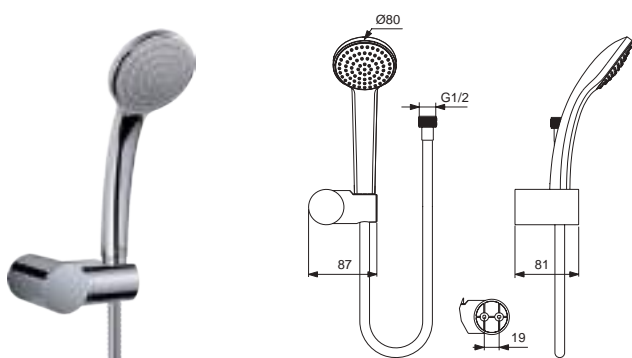

MINIKIT IDEALRAIN S1

Acabado: Cromo Brillo	Ref.	€/Ud.	Stock	Cant.
Round 1 función	B9506AA	32		6

- Ducha extraíble de \varnothing 80mm
- **1 función con difusores de silicona anticalcáreos**
- Manguera de ducha Idealflex 1500mm
- Reductor de caudal 8L/min 3 bars
- Soporte a pared articulado



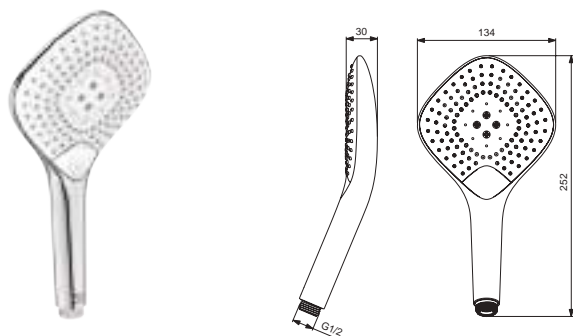

IDEALRAIN EVO JET KIT DUCHA

Acabado: Cromo Brillo	Ref.	€/Ud.	Stock	Cant.
Diamond 3 funciones	B1760AA	70		6

- Ducha de mano Diamond
- **Botón Navigo**
- 3 funciones: lluvia, drop-jet y masaje
- Difusores de silicona anticalcáreos

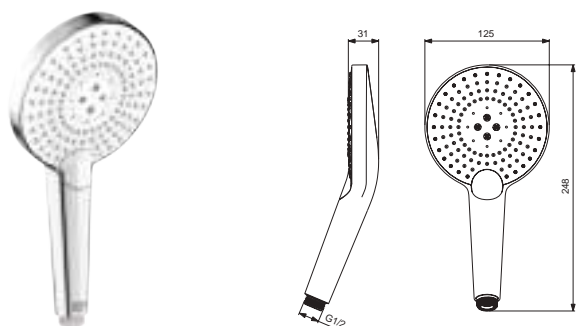

IDEALRAIN EVO JET KIT DUCHA

Acabado: Cromo Brillo	Ref.	€/Ud.	Stock	Cant.
Round 3 funciones	B1759AA	70		6

- Ducha de mano Round
- **Botón Navigo**
- 3 funciones: lluvia, drop-jet y masaje
- Difusores de silicona anticalcáreos

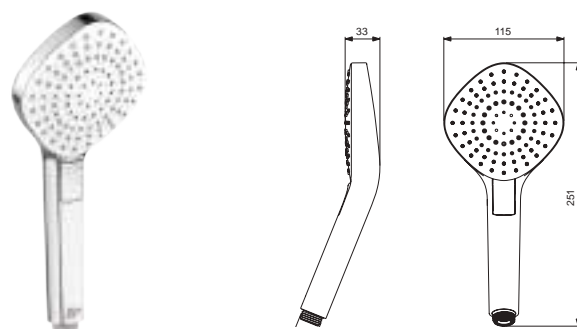

IDEALRAIN EVO KIT DUCHA

Acabado: Cromo Brillo	Ref.	€/Ud.	Stock	Cant.
Diamond 3 funciones	B2232AA	45		6

- Ducha de mano Diamond
- **Botón Navigo**
- 3 funciones: lluvia, lluvia fina y masaje
- Difusores de silicona anticalcáreos

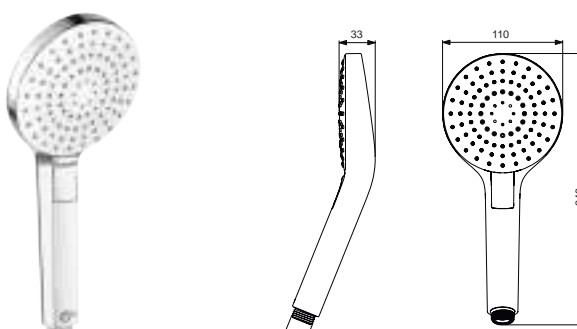

IDEALRAIN EVO KIT DUCHA

Acabado: Cromo Brillo	Ref.	€/Ud.	Stock	Cant.
Round 3 funciones	B2231AA	45		6

- Ducha de mano Round
- **Botón Navigo**
- 3 funciones: lluvia, lluvia fina y masaje
- Difusores de silicona anticalcáreos



TELEDUCHA



TELEDUCHA IDEALRAIN M3

Acabado: Cromo Brillo	Ref.	€/Ud.	Stock	Cant.
Round 3 funciones	B9403AA	28		6

- Ducha extraíble de ø100mm
- Difusores de silicona anticalcáreos
- **3 Funciones: lluvia, lluvia fina, masaje**
- Reductor de caudal 8L/min 3 bars



TELEDUCHA IDEALRAIN M1

Acabado: Cromo Brillo	Ref.	€/Ud.	Stock	Cant.
Round 1 función	B9402AA	17		6

- Ducha extraíble de ø100mm
- **1 función con difusores de silicona anticalcáreos**
- Reductor de caudal 8L/min 3 bars



TELEDUCHA IDEALRAIN S3

Acabado: Cromo Brillo	Ref.	€/Ud.	Stock	Cant.
Round 3 funciones	B9401AA	25		6

- Ducha extraíble de ø80mm
- Difusores de silicona anticalcáreos
- **3 Funciones: lluvia, lluvia fina, masaje**
- Reductor de caudal 8L/min 3 bars



TELEDUCHA IDEALRAIN S1

Acabado: Cromo Brillo	Ref.	€/Ud.	Stock	Cant.
Round 1 función	B9400AA	15		6

- Ducha extraíble de ø80mm
- **1 función con difusores de silicona anticalcáreos**
- Reductor de caudal 8L/min 3 bars



DUCHAS ACCESORIOS

ROCIADORES

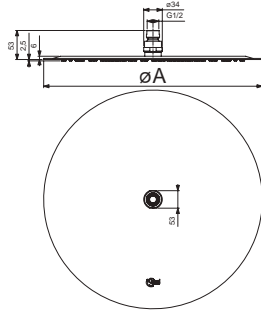

ROCIADORES LUXE REDONDOS

Acabado: Cromo Brillo	Ref.	€/Ud.	Stock	Cant.
Rociador Idealrain luxe 40cm	B0386MY	400		6
Rociador Idealrain luxe 30cm	B0385MY	350		6
Rociador Idealrain luxe 25cm	B0384MY	300		6
Rociador Idealrain luxe 20cm	B0383MY	275		6

- Boquillas de silicona fáciles de limpiar para prevenir acumulación de sarro y cal
- Pivota 10°
- Patrón de lluvia fina de alto rendimiento
- Limitador de caudal 12 L/MIN
- Diseño ultrafino de 2,5 mm

	A
B0386MY	400
B0385MY	300
B0384MY	250
B0383MY	200

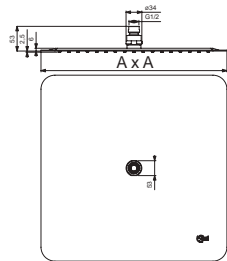

ROCIADORES LUXE CUADRADOS

Acabado: Cromo Brillo	Ref.	€/Ud.	Stock	Cant.
Rociador Idealrain luxe 40cm	B0389MY	450		6
Rociador Idealrain luxe 30cm	B0388MY	350		6
Rociador Idealrain luxe 20cm	B0387MY	275		6

- Boquillas de silicona fáciles de limpiar para prevenir acumulación de sarro y cal
- Pivota 10°
- Patrón de lluvia fina de alto rendimiento
- Limitador de caudal 12 L/MIN
- Diseño ultrafino de 2,5 mm

	A
B0389MY	400 x 400
B0388MY	300 x 300
B0387MY	200 x 200

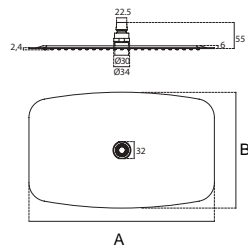

ROCIADORES LUXE RECTANGULARES

Acabado: Cromo Brillo	Ref.	€/Ud.	Stock	Cant.
Rociador Idealrain luxe 40x25cm	B0391MY	400		6
Rociador Idealrain luxe 30x20cm	B0390MY	350		6

- Boquillas de silicona fáciles de limpiar para prevenir acumulación de sarro y cal
- Pivota 10°
- Patrón de lluvia fina de alto rendimiento
- Limitador de caudal 12 L/MIN
- Diseño ultrafino de 2,5 mm

	A	B
B0391MY	400	250
B0390MY	300	200

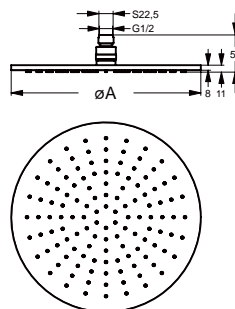

ROCIADORES REDONDOS

Acabado: Cromo Brillo	Ref.	€/Ud.	Stock	Cant.
Rociador Idealrain 30cm	B9443AA	270		6
Rociador Idealrain 20cm	B9442AA	210		6
Rociador Idealrain 10cm	B9435AA	180		6

- Boquillas de silicona fáciles de limpiar para prevenir acumulación de sarro y cal
- Pivota 10°
- Patrón de lluvia fina de alto rendimiento
- Limitador de caudal 12 L/MIN
- Diseño fino de 8 mm

	A
B9443AA	300
B9442AA	200
B9435AA	100

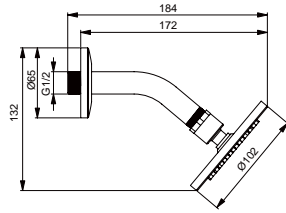

ROCIADOR REDONDO CON BRAZO ARTICULADO

Acabado: Cromo Brillo	Ref.	€/Ud.	Stock	Cant.
Rociador redondo 10cm con brazo	B9436AA	190		6

- Boquillas de silicona fáciles de limpiar para prevenir acumulación de sarro y cal
- Pivota 10º
- Patrón de lluvia fina de alto rendimiento
- Limitador de caudal 12 L/MIN
- Diseño fino de 8 mm

ROCIADORES

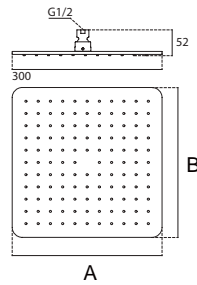

ROCIADORES CUADRADOS

Acabado: Cromo Brillo	Ref.	€/Ud.	Stock	Cant.
Rociador Idealrain 30cm	B0025AA	300		6
Rociador Idealrain 20cm	B0024AA	210		6

- Boquillas de silicona fáciles de limpiar para prevenir acumulación de sarro y cal
- Pivota 10º
- Patrón de lluvia fina de alto rendimiento
- Limitador de caudal 12 L/MIN
- Diseño fino de 8 mm

	A	B
B0025AA	300	300
B0024AA	200	200

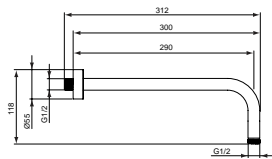

SOPORTES ROCIADORES MURO

Acabado: Cromo Brillo	Ref.	€/Ud.	Stock	Cant.
Soporte rociador muro 30cm	B9444AA	75		6
Soporte rociador muro 40cm	B9445AA	100		6

- Fijación mural a pared

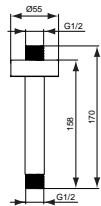

SOPORTE ROCIADOR TECHO

Acabado: Cromo Brillo	Ref.	€/Ud.	Stock	Cant.
Soporte rociador techo	B9446AA	53		6

- Fijación mural a techo

FLEXOS



MANGUERAS IDEALFLEX

Acabado: Cromo Brillo	Ref.	€/Ud.	Stock	Cant.
Idealflex tubo 1250 mm	A3306AA	20	<input checked="" type="checkbox"/>	6
Idealflex tubo 1600 mm	A3330AA	25	<input checked="" type="checkbox"/>	6
Idealflex tubo 1750 mm	A4109AA	30	<input checked="" type="checkbox"/>	6

- Realizado en plástico
- Acabado metálico
- Rosca de conexión G1/2 x G1/2

DUCHAS ACCESORIOS

BARRAS



EXTENSOR DE BARRA

Acabado: Cromo Brillo	Ref.	€/Ud.	Stock	Cant.
Extensor de 150mm	A860873AA	45		6

· Extensor para las barras de ducha con fijación square y round

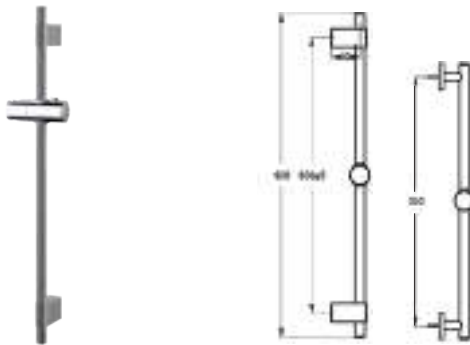

BARRA DE DUCHA FIJACIÓN SQUARE

Acabado: Cromo Brillo	Ref.	€/Ud.	Stock	Cant.
Barra de ducha 600mm	B9428AA	45		6
Barra de ducha 900mm	B9429AA	55		6

· Barra ducha 600mm o 900mm de $\varnothing 20,6$ mm
 · **Soporte de ducha de metal con perno redondo de desplazamiento**
 · Tornillo de fijación incluidos
 · Con fijación para la ducha deslizante

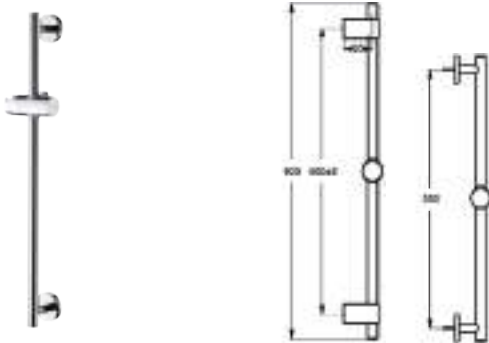

BARRA DE DUCHA FIJACIÓN ROUND

Acabado: Cromo Brillo	Ref.	€/Ud.	Stock	Cant.
Barra de ducha 600mm	B9420AA	35		6
Barra de ducha 720mm	B9421AA	40		6
Barra de ducha 900mm	B9422AA	45		6

· Barra ducha 600mm, 720mm o 900mm de $\varnothing 20,6$ mm
 · **Soporte de ducha de metal con perno redondo de desplazamiento**
 · Tornillo de fijación incluidos
 · Con fijación para la ducha deslizante

SOPORTES

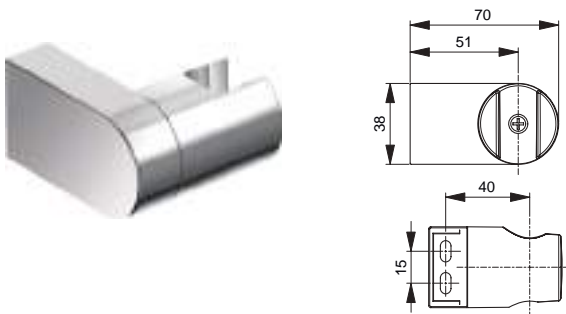

SOPORTE A PARED

Acabado: Cromo Brillo	Ref.	€/Ud.	Stock	Cant.
Regulable Square	B0029AA	20		6

· Soporte de ducha móvil de metal
 · **Instalación ultra-resistente con dos puntos de fijación**
 · Tornillos de fijación incluidos

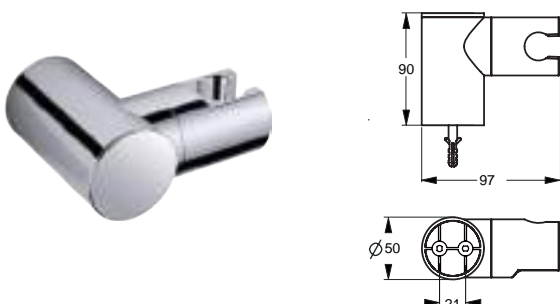

SOPORTE A PARED

Acabado: Cromo Brillo	Ref.	€/Ud.	Stock	Cant.
Regulable Round	B9468AA	20		6

· Soporte de ducha móvil de metal
 · **Instalación ultra-resistente con dos puntos de fijación**
 · Tornillos de fijación incluidos

SOPORTES

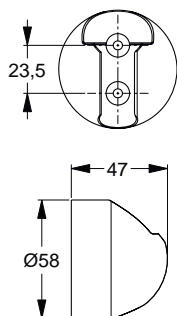

SOPORTE A PARED

Acabado: Cromo Brillo	Ref.	€/Ud.	Stock	Cant.
Fijo	B9467AA	20		6

- Soporte de ducha móvil de metal
- **Instalación ultra-resistente con dos puntos de fijación**
- Tornillos de fijación incluidos

OTROS

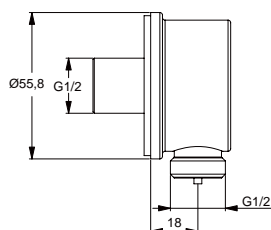

TOMA AGUA

Acabado: Cromo Brillo	Ref.	€/Ud.	Stock	Cant.
Toma de agua	B9448AA	20		6

- Codo a pared

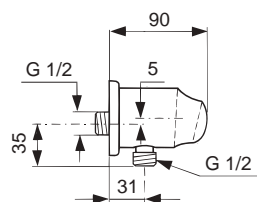

TOMA AGUA CON SOPORTE

Acabado: Cromo Brillo	Ref.	€/Ud.	Stock	Cant.
Toma de agua con soporte de ducha	A2406AA	40	<input checked="" type="checkbox"/>	6

- Codo a pared con soporte para ducha
- M1/2" - M1/2 en metal

IDEAL STANDARD

GRIFERÍA ESPECIALIZADA

Máxima precisión para una optimización de los recursos naturales y control de infecciones.

LEYENDA DE ICONOS



Limitador temperatura



Cool Body



Ahorro de agua



Tecnología Click



Ahorro de energía



Easy Fix



Flexible incorporado



Caño autodrenante



Aireador antivandálico. Limita la aparición de bacterias



GRIFERÍA

CERAPLUS

Con un innovador sistema temporizador, ideal para espacios públicos, permite el ahorro de agua a través de un diseño funcional.



GRIFERÍA **NOVEDAD**

CERAPLUS 2.0

Funcionalidad, ergonomía, seguridad y fiabilidad definen a esta grifería especializada para instalaciones sanitarias. Una solución capaz de cumplir con las más altas exigencias de un entorno tan especial.





INFORMACIÓN TÉCNICA

GRIFERÍA ESPECIALIZADA

Soluciones tecnológicas de calidad para los
ámbitos más especializados.

GRIFERÍA

CERAPLUS | ELECTRÓNICAS Y TEMPORIZADAS



ELECTRÓNICAS



TEMPORIZADAS

CERAPLUS 2.0 | GRIFERÍA ESPECIALIZADA



LAVABO

LAVABO
A PAREDBAÑO Y DUCHA
EXTERIORBAÑO Y DUCHA
EMPOTRADO

GRIFERÍA ELECTRÓNICAS Y TEMPORIZADAS

LAVABO ELECTRÓNICO

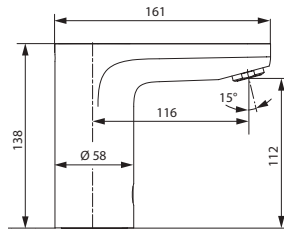

MEZCLADOR ELECTRÓNICO

Acabado: Cromo Brillo	Ref.	€/Ud.	Stock	Cant.
Con batería y temperatura ajustable	A6145AA	425		6

- Control de temperatura ajustable por el usuario
- Idealblue® cuerpo y conducto de agua libre de níquel
- **Limitador de caudal 4L/min**
- Sistema EasyFix montaje rápido
- Latiguillos flexibles
- Válvulas de aislamiento con filtros y válvulas de retención

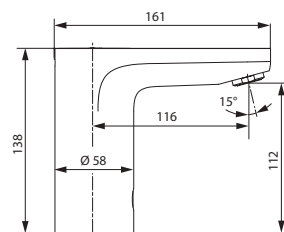

MEZCLADOR ELECTRÓNICO

Acabado: Cromo Brillo	Ref.	€/Ud.	Stock	Cant.
Sin batería y temperatura ajustable	A6146AA	425		6

- Control de temperatura ajustable por el usuario
- Idealblue® cuerpo y conducto de agua libre de níquel
- **Limitador de caudal 4L/min**
- Sistema EasyFix montaje rápido
- Latiguillos flexibles
- Válvulas de aislamiento con filtros y válvulas de retención

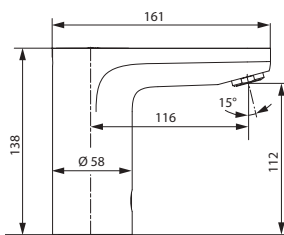

GRIFO ELECTRÓNICO

Acabado: Cromo Brillo	Ref.	€/Ud.	Stock	Cant.
Con batería y sin ajuste de temperatura	A6143AA	375		6

- Control de temperatura ajustable por el usuario
- Idealblue® cuerpo y conducto de agua libre de níquel
- **Limitador de caudal 4L/min**
- Sistema EasyFix montaje rápido
- Latiguillo flexible
- Válvulas de aislamiento con filtros y válvulas de retención

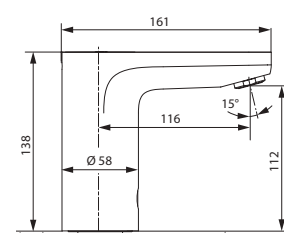

GRIFO ELECTRÓNICO

Acabado: Cromo Brillo	Ref.	€/Ud.	Stock	Cant.
Sin batería y sin ajuste de temperatura	A6144AA	375		6

- Control de temperatura ajustable por el usuario
- Idealblue® cuerpo y conducto de agua libre de níquel
- **Limitador de caudal 4L/min**
- Sistema EasyFix montaje rápido
- Latiguillo flexible
- Válvulas de aislamiento con filtros y válvulas de retención



LAVABO TEMPORIZADO

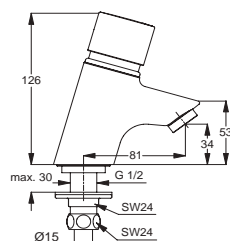

GRIFO PULSADOR LAVAMANOS TEMPORIZADO

Acabado: Cromo Brillo	Ref.	€/Ud.	Stock	Cant.
Sin válvula y sin ajuste de temperatura	B8301AA	120		6

- Aireador antivandálico
- Tubo flexible NEOFLEX®SPX (Soft PEX)

NOVEDAD

LAVABO TEMPORIZADO

MEZCLADOR LAVABO TEMPORIZADO



NOVEDAD

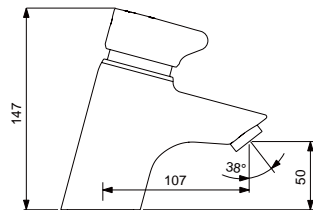

Acabado: Cromo Brillo	Ref.	€/Ud.	Stock	Cant.
Temperatura ajustable	B8295AA	300		6

- Mezclador temporizado de caño fijo
- **Aireador de flujo estructura laminar antivandálico 24x1**
- Válvula desagüe y varilla metálica incorporada
- Tubo flexible NEOFLEX®SPX (Soft PEX)
- Conexiones "S" on/off con reducción de ruido integrado
- Sistema de sujeción EasyFix



GRIFO PULSADOR LAVABO TEMPORIZADO



NOVEDAD

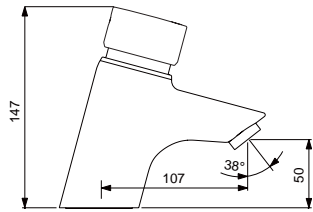

Acabado: Cromo Brillo	Ref.	€/Ud.	Stock	Cant.
Sin ajuste de temperatura	B8296AA	240		6

- Mezclador temporizado de caño fijo
- **Aireador de flujo estructura laminar antivandálico 24x1**
- Válvula desagüe y varilla metálica incorporada
- Tubo flexible NEOFLEX®SPX (Soft PEX)
- Conexiones "S" on/off con reducción de ruido integrado
- Sistema de sujeción EasyFix



GRUPO EXTERIOR PULSADOR DUCHA

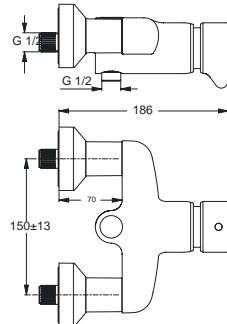

Acabado: Cromo Brillo	Ref.	€/Ud.	Stock	Cant.
Temporizado sin accesorios	B8297AA	320		6

- **Monomando exterior temporizado para ducha**
- Conexiones "S" on/off con reducción de ruido integrado
- Distancia desde el centro 136 a 164mm

GRUPO EMPOTRADO PULSADOR DUCHA

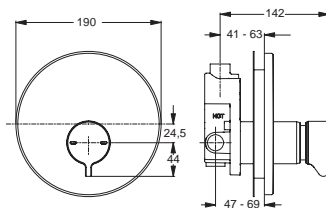

Acabado: Cromo Brillo	Ref.	€/Ud.	Stock	Cant.
Temporizado temperatura ajustable	B8299AA	260		6

- **Monomando empotrable temporizado para ducha**
- Incluye cuerpo empotrado

GRUPO EMPOTRADO PULSADOR URINAL

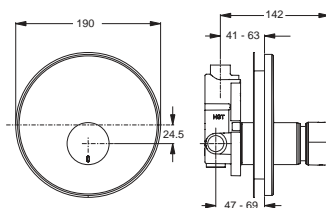

Acabado: Cromo Brillo	Ref.	€/Ud.	Stock	Cant.
Temporizado	B8300AA	250		6

- **Monomando empotrable temporizado para ducha**
- Incluye cuerpo empotrado

NOVEDAD

GRIFERÍA NOVEDAD CERAPLUS 2.0

LAVABO

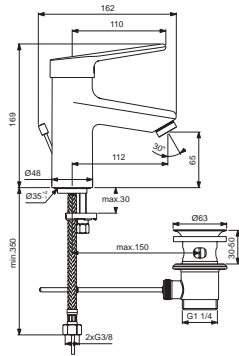

MONOMANDO LAVABO NORMAL

Acabado: Cromo Brillo	Ref.	€/Ud.	Stock	Cant.
Con válvula y maneta normal	BC091AA	150		6
Sin válvula y maneta normal	BC092AA	140		6

- Caño autodrenante
- Aireador antivandálico / limita la aparición de bacterias
- Cartucho cerámico de 38mm
- Limitador de temperatura integrado
- Latiguillos flexibles 3/8"
- Easy Fix

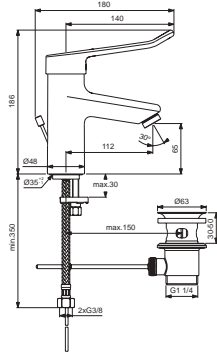

MONOMANDO LAVABO NORMAL

Acabado: Cromo Brillo	Ref.	€/Ud.	Stock	Cant.
Con válvula y maneta abierta	BC095AA	155		6
Sin válvula y maneta abierta	BC096AA	145		6

- Caño autodrenante
- Aireador antivandálico / limita la aparición de bacterias
- Cartucho cerámico de 38mm
- Limitador de temperatura integrado
- Latiguillos flexibles 3/8"
- Easy Fix

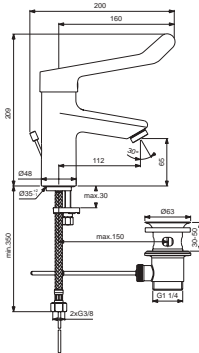

MONOMANDO LAVABO NORMAL

Acabado: Cromo Brillo	Ref.	€/Ud.	Stock	Cant.
Con válvula y maneta gerontológica	BC097AA	165		6
Sin válvula y maneta gerontológica	BC098AA	155		6

- Caño autodrenante
- Aireador antivandálico / limita la aparición de bacterias
- Cartucho cerámico de 38mm
- Limitador de temperatura integrado
- Latiguillos flexibles 3/8"
- Easy Fix

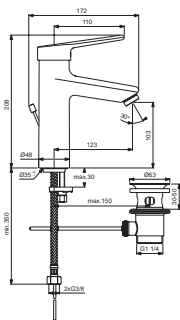

MONOMANDO LAVABO GRANDE

Acabado: Cromo Brillo	Ref.	€/Ud.	Stock	Cant.
Con válvula y maneta normal	BC099AA	170		6
Sin válvula y maneta normal	BC100AA	160		6

- Caño autodrenante
- Aireador antivandálico / limita la aparición de bacterias
- Cartucho cerámico de 38mm
- Limitador de temperatura integrado
- Latiguillos flexibles 3/8"
- Easy Fix

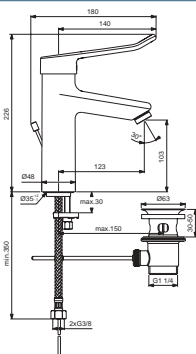

MONOMANDO LAVABO GRANDE

Acabado: Cromo Brillo	Ref.	€/Ud.	Stock	Cant.
Con válvula y maneta abierta	BC103AA	175		6
Sin válvula y maneta abierta	BC104AA	165		6

- Caño autodrenante
- Aireador antivandálico / limita la aparición de bacterias
- Cartucho cerámico de 38mm
- Limitador de temperatura integrado
- Latiguillos flexibles 3/8"
- Easy Fix



LAVABO

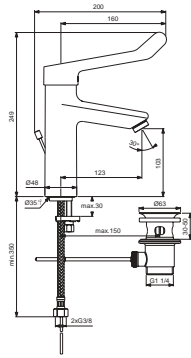

MONOMANDO LAVABO GRANDE

Acabado: Cromo Brillo	Ref.	€/Ud.	Stock	Cant.
Con válvula y maneta gerontológica	BC105AA	185		6
Sin válvula y maneta gerontológica	BC106AA	175		6

- Caño autodrenante
- Aireador antivandálico / limita la aparición de bacterias
- Cartucho cerámico de 38mm
- Limitador de temperatura integrado
- Latiguillos flexibles 3/8"
- Easy Fix

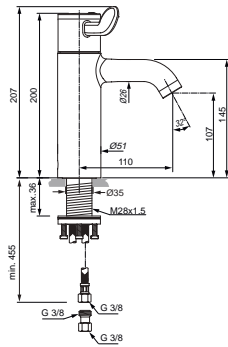

MONOMANDO TERMOSTATICO LAVABO ENCIMERA

Acabado: Cromo Brillo	Ref.	€/Ud.	Stock	Cant.
Sin válvula y maneta gerontológica	A6692AA	500		6

- Caño autodrenante
- Aireador antivandálico / limita la aparición de bacterias
- Cierre en frío para evitar bacterias
- Limitador de temperatura integrado
- Latiguillos flexibles 3/8"
- Easy Fix

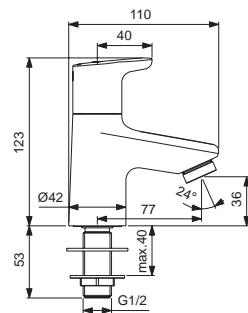

GRIFO LAVAMANOS

Acabado: Cromo Brillo	Ref.	€/Ud.	Stock	Cant.
Sin válvula y una vía	BC117AA	95		6

- Caño autodrenante
- Aireador antivandálico / limita la aparición de bacterias

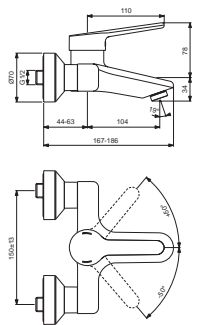

MONOMANDO LAVABO A PARED

Acabado: Cromo Brillo	Ref.	€/Ud.	Stock	Cant.
Caño fijo y maneta normal	BC108AA	225		6

- Caño autodrenante
- Aireador antivandálico / limita la aparición de bacterias
- Cartucho cerámico de 38mm
- Limitador de temperatura integrado
- Embellecedores con junta de estanqueidad

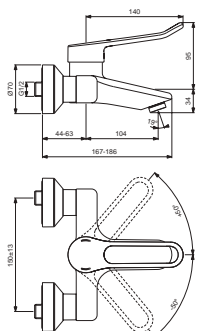

MONOMANDO LAVABO A PARED

Acabado: Cromo Brillo	Ref.	€/Ud.	Stock	Cant.
Caño fijo y maneta abierta	BC109AA	230		6

- Caño autodrenante
- Aireador antivandálico / limita la aparición de bacterias
- Cartucho cerámico de 38mm
- Limitador de temperatura integrado
- Embellecedores con junta de estanqueidad



GRIFERÍA NOVEDAD CERAPLUS 2.0

LAVABO

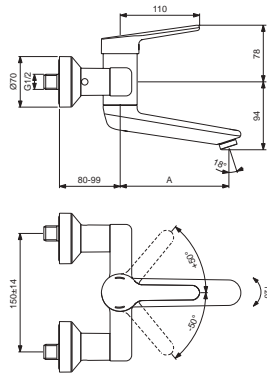

MONOMANDO LAVABO A PARED

Acabado: Cromo Brillo	Ref.	€/Ud.	Stock	Cant.
S-conectores ON/OFF Caño 100mm	BC110AA	265		6
S-conectores ON/OFF Caño 150mm	BC111AA	275		6
S-conectores ON/OFF Caño 200mm	BC112AA	285		6
S-conectores ON/OFF Caño 250mm	BC113AA	295		6

- Caño giratorio 100mm
- Aireador antivandálico / limita la aparición de bacterias
- Cartucho cerámico de 38mm
- Limitador de temperatura integrado
- Embellecedores con junta de estanqueidad



	A
BC110AA	100
BC111AA	150
BC112AA	200
BC113AA	250

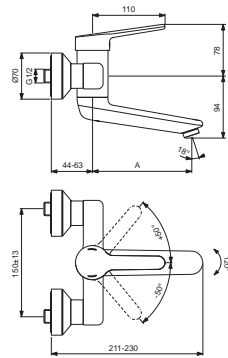

MONOMANDO LAVABO A PARED

Acabado: Cromo Brillo	Ref.	€/Ud.	Stock	Cant.
Monomando con caño 100 mm	BC114AA	225		6
Monomando con caño 150 mm	BC115AA	250		6
Monomando con caño 200 mm	BC116AA	275		6

- Caño giratorio 150mm
- Aireador antivandálico / limita la aparición de bacterias
- Cartucho cerámico de 38mm
- Limitador de temperatura integrado
- Embellecedores con junta de estanqueidad



	A
BC114AA	100
BC115AA	150
BC116AA	200

DUCHA EXTERIOR

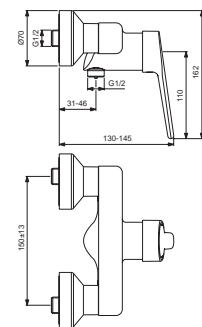

MONOMANDO DUCHA EXTERIOR

Acabado: Cromo Brillo	Ref.	€/Ud.	Stock	Cant.
Con maneta larga	BC118AA	140		6

- Maneta de 110mm
- S-conectores con embellecedores
- Cartucho cerámico de 38mm
- Limitador de temperatura integrado



TERMOSTÁTICAS BAÑO Y DUCHA EXTERIOR

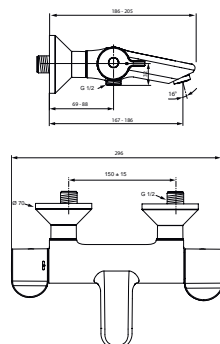

MEZCLADOR TERMOSTÁTICO BAÑO/DUCHA

Acabado: Cromo Brillo	Ref.	€/Ud.	Stock	Cant.
Exterior sin s-conectores on/off	A6873AA	530		6
Exterior con s-conectores on/off	A6874AA	550		6

- Cool body
- Cartucho termostático
- Apto para desinfección termostática con herramienta incluida
- Válvula antirretorno incluido
- Manetas metálicas
- Embellecedores con junta de estanqueidad



TERMOSTÁTICAS BAÑO Y DUCHA EXTERIOR

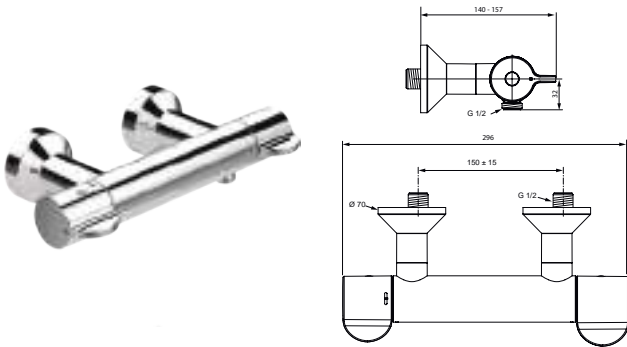

MEZCLADOR TERMOSTÁTICO DUCHA

Acabado: Cromo Brillo	Ref.	€/Ud.	Stock	Cant.
Exterior con s-conectores on/off	A6870AA	400		6

- Cool body
- **Cartucho termostático**
- Apto para desinfección termostática con herramienta incluida
- Válvula antirretorno incluido
- Manetas metálicas
- Embellecedores con junta de estanqueidad



BAÑO Y DUCHA EMPOTRADO

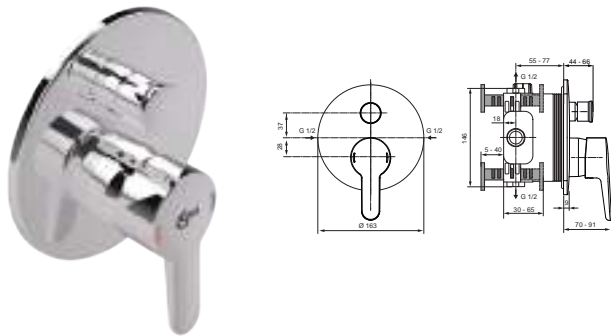

MONOMANDO BAÑO/DUCHA EMPOTRADO

Acabado: Cromo Brillo	Ref.	€/Ud.	Stock	Cant.
Empotrado Kit 2	A6866AA	240		6

- **Cartucho cerámico 47 mm con click technology**
- Limitador de temperatura integrado
- Embellecedores metálicos
- **Cuerpo empotrado no incluido** (completar con A1000NU)

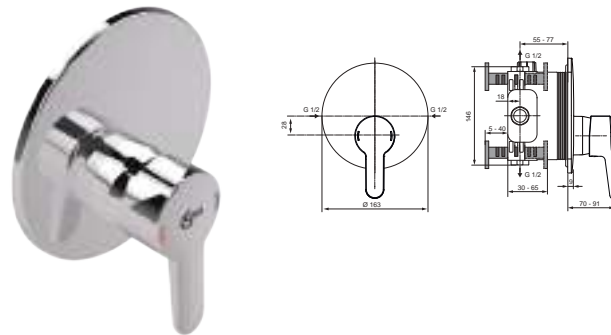

MONOMANDO DUCHA EMPOTRADO

Acabado: Cromo Brillo	Ref.	€/Ud.	Stock	Cant.
Empotrado Kit 2	A6865AA	220		6

- **Cartucho cerámico 47 mm con click technology**
- Limitador de temperatura integrado
- Embellecedores metálicos
- **Cuerpo empotrado no incluido** (completar con A1000NU)



TERMOSTÁTICAS BAÑO Y DUCHA EMPOTRADO

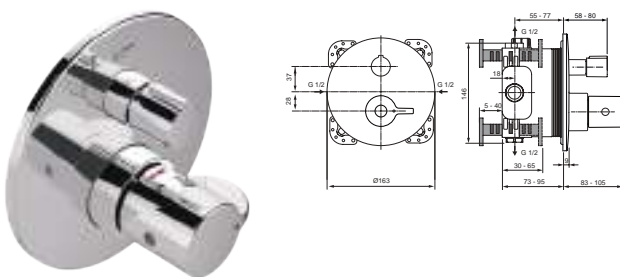

MEZCLADOR TERMOSTÁTICO BAÑO/DUCHA

Acabado: Cromo Brillo	Ref.	€/Ud.	Stock	Cant.
Empotrado Kit 2 con desinfección termostática	A6869AA	550		6

- **Cartucho termostático**
- Limitador de temperatura integrado
- Apto para desinfección termostática con herramienta incluida
- Válvula antirretorno incluido
- Maneta y embellecedor metálica
- **Cuerpo empotrado no incluido** (completar con A1000NU)

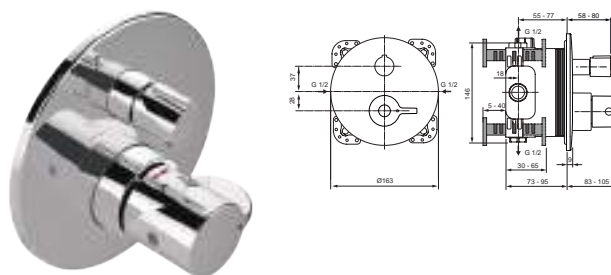

MEZCLADOR TERMOSTÁTICO DUCHA

Acabado: Cromo Brillo	Ref.	€/Ud.	Stock	Cant.
Empotrado Kit 2 con desinfección termostática	A6868AA	480		6

- **Cartucho termostático**
- Limitador de temperatura integrado
- Apto para desinfección termostática con herramienta incluida
- Válvula antirretorno incluido
- Maneta y embellecedor metálica
- **Cuerpo empotrado no incluido** (completar con A1000NU)



GRIFERÍA NOVEDAD CERAPLUS 2.0

LAVABO

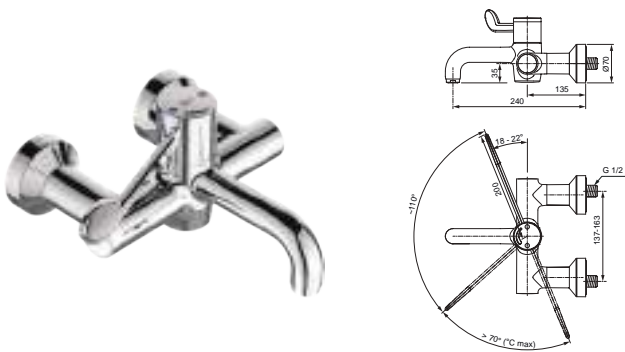

MONOMANDO LAVABO TERMOSTÁTICO

Acabado: Cromo Brillo	Ref.	€/Ud.	Stock	Cant.
Exterior sin s-conectores on/off	A6690AA	500		6
Exterior con s-conectores on/off	A6691AA	600		6

- Caño autodrenante con limitación de la aparición de bacterias
- Laminar caudal de agua
- Cartucho de seguridad con limitador de temperatura ajustable
- Apto para desinfección termostática con herramienta incluida
- Desacoplamiento térmico
- Embellecedores con junta de estanqueidad

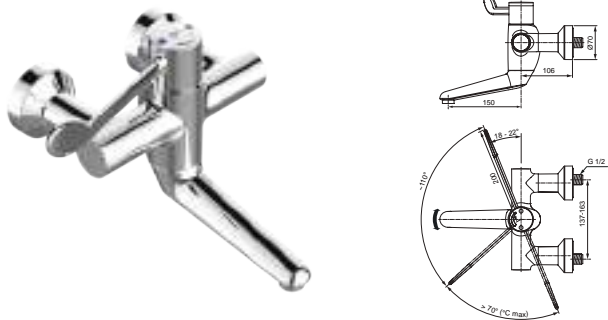

MONOMANDO LAVABO TERMOSTÁTICO

Acabado: Cromo Brillo	Ref.	€/Ud.	Stock	Cant.
Exterior con s-conectores on/off y caño giratorio 150 mm	A6699AA	750		6
Exterior sin s-conectores on/off y con caño giratorio 150 mm	A6702AA	700		6

- Exterior con s-conectores on/off y caño giratorio 150 mm
- Caño autodrenante y giratorio (fijo, +/-45°, +/- 180°)
- Laminar caudal de agua
- Cartucho de seguridad con limitador de temperatura ajustable
- Apto para desinfección termostática con herramienta incluida
- Desacoplamiento térmico
- Embellecedores con junta de estanqueidad

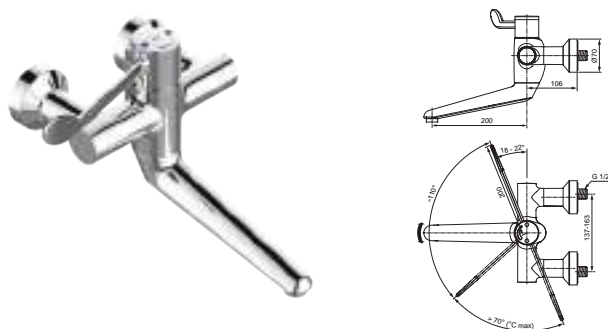

MONOMANDO LAVABO TERMOSTÁTICO

Acabado: Cromo Brillo	Ref.	€/Ud.	Stock	Cant.
Exterior con s-conectores on/off y caño giratorio 200 mm	A6700AA	800		6
Exterior con caño giratorio 200 mm	A6703AA	750		6

- Exterior con s-conectores on/off y caño giratorio 150 mm
- Caño autodrenante y giratorio (fijo, +/-45°, +/- 180°)
- Laminar caudal de agua
- Cartucho de seguridad con limitador de temperatura ajustable
- Apto para desinfección termostática con herramienta incluida
- Desacoplamiento térmico
- Embellecedores con junta de estanqueidad

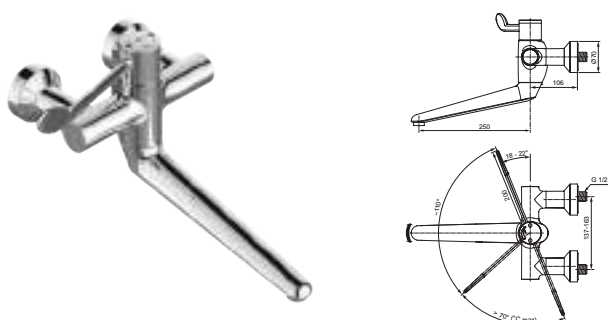

MONOMANDO LAVABO TERMOSTÁTICO

Acabado: Cromo Brillo	Ref.	€/Ud.	Stock	Cant.
Exterior con s-conectores on/off y caño giratorio 250 mm	A6701AA	850		6
Exterior con caño giratorio 250 mm	A6704AA	775		6

- Exterior con s-conectores on/off y caño giratorio 150 mm
- Caño autodrenante y giratorio (fijo, +/-45°, +/- 180°)
- Laminar caudal de agua
- Cartucho de seguridad con limitador de temperatura ajustable
- Apto para desinfección termostática con herramienta incluida
- Desacoplamiento térmico
- Embellecedores con junta de estanqueidad



ACCESORIOS CERAPLUS 2.0



Acabado: Blanco Brillo	Ref.	Stock	Cant.	€/Ud.
Válvula de desagüe para teleducha	F2605AA		6	115



Acabado: Blanco Brillo	Ref.	Stock	Cant.	€/Ud.
Válvula para desinfección térmica	A5776AA		6	223



Acabado: Blanco Brillo	Ref.	Stock	Cant.	€/Ud.
Kit de conexión para válvula para desinfección térmica	A5777AA		6	45

IDEAL STANDARD

GRIFERÍA DE COCINA

Griferías especializadas para tu hogar.
Máxima comodidad y funcionalidad que se adaptan a cualquier estilo.

LEYENDA DE ICONOS



Bluestart



Ahorro de energía



Limitador de caudal



Flexible incorporado



Limitador temperatura



Tecnología Click



Ahorro de agua



Easy Fix



GRIFERÍA COCINA

Ideales para el ritmo del día a día, permiten lavar, fregar y cocinar con la máxima comodidad.

CERALOOK



CERAPLAN III



CERAFLEX





INFORMACIÓN TÉCNICA

COCINA

Grifería doméstica para tu día a día.

GRIFERÍA



MONOMANDO COCINA
CERAPLAN III



MONOMANDO COCINA
CERAFLEX



MONOMANDO COCINA
CERALOOK

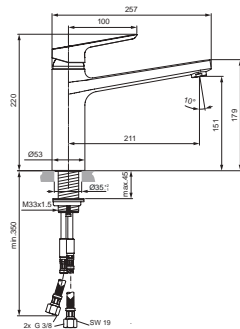

MONOMANDO COCINA CAÑO ALTO

Acabado: Cromo Brillo	Ref.	€/Ud.	Stock	Cant.
Giratorio	B0952AA	195		6

- Cuerpo giratorio 360°
- **Cartucho cerámico 35mm**
- Limitador de temperatura
- Latiguillos flexibles 3/8"
- Easy Fix

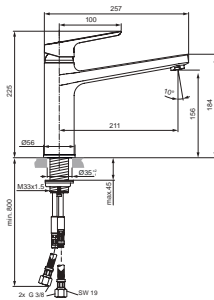

MONOMANDO COCINA CAÑO ALTO

Acabado: Cromo Brillo	Ref.	€/Ud.	Stock	Cant.
Giratorio y abatible	B0954AA	225		6

- Cuerpo giratorio 360° y abatible
- **Cartucho cerámico 35mm**
- Limitador de temperatura
- Latiguillos flexibles 3/8"
- Easy Fix

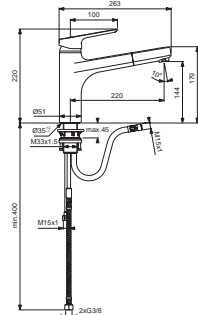

MONOMANDO COCINA CAÑO ALTO

Acabado: Cromo Brillo	Ref.	€/Ud.	Stock	Cant.
Giratorio y extraíble	B0956AA	205		6

- Cuerpo giratorio 120°
- Caño extraíble 500mm
- **Cartucho cerámico 35mm**
- Limitador de temperatura
- Latiguillos flexibles 3/8"
- Easy Fix

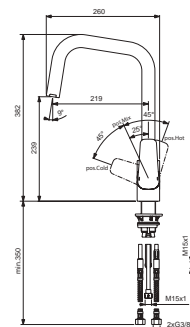

MONOMANDO COCINA CAÑO TUBULAR

Acabado: Cromo Brillo	Ref.	€/Ud.	Stock	Cant.
Giratorio y extraíble	B0960AA	225		6

- Aireador extraíble
- **Cartucho cerámico 35mm**
- Limitador de temperatura
- Latiguillos flexibles 3/8"
- Easy Fix



NOVEDAD COCINA CERALOOK

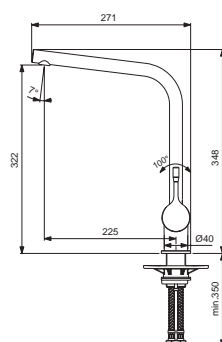

MONOMANDO COCINA CAÑO TUBULAR

Acabado: Cromo Brillab	Ref.	€/Ud.	Stock	Cant.
Giratorio y luestart	BC174AA	155		6

- **Tecnología Bluestart:** Apertura en frío
- **Cartucho cerámico 38mm CLICK**
- 32cm altura, 22,5 cm proyeccion
- Latiguillos flexibles 3/8"



NOVEDAD COCINA CERALOOK

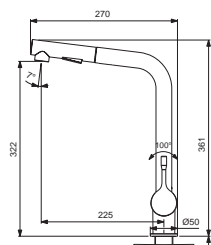

MONOMANDO COCINA CAÑO TUBULAR

Acabado: Cromo Brillo	Ref.	€/Ud.	Stock	Cant.
Giratorio, caño extraíble y Bluestart	BC178AA	230		6

- Tecnología Bluestart: Apertura en frío
- Cartucho cerámico 38mm CLICK
- Caño extraíble con 2 funciones
- Latiguillos flexibles 3/8"

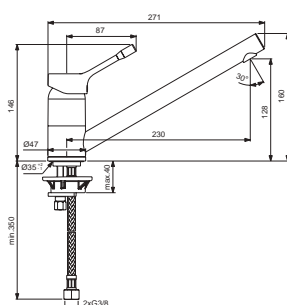

MONOMANDO COCINA BLUESTART

Acabado: Cromo Brillo	Ref.	€/Ud.	Stock	Cant.
Giratorio	BC292AA	115		6

- Tecnología Bluestart: Apertura en frío
- Cartucho cerámico 38mm CLICK
- 14,5cm altura, 23 cm proyección
- Latiguillos flexibles 3/8"

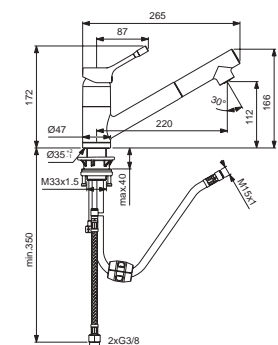

MONOMANDO COCINA BLUESTART

Acabado: Cromo Brillo	Ref.	€/Ud.	Stock	Cant.
Giratorio y caño estraible	BC294AA	160		6

- Tecnología Bluestart: Apertura en frío
- Cartucho cerámico 38mm CLICK
- Caño extraíble con 1 función
- Latiguillos flexibles 3/8"

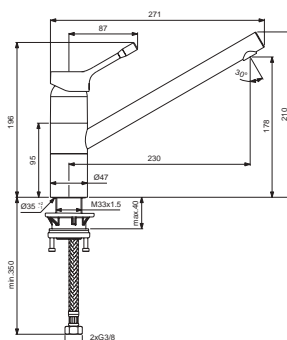

MONOMANDO COCINA CAÑO ALTO BLUESTART

Acabado: Cromo Brillo	Ref.	€/Ud.	Stock	Cant.
Giratorio	BC295AA	145		6

- Tecnología Bluestart: Apertura en frío
- Cartucho cerámico 38mm CLICK
- Caño extraíble con 1 función
- Latiguillos flexibles 3/8"

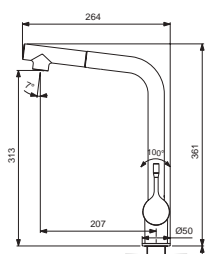

MONOMANDO COCINA CAÑO TUBULAR

Acabado: Cromo Brillo	Ref.	€/Ud.	Stock	Cant.
Giratorio, caño extraíble y Bluestart	BC176AA	210		6

- Tecnología Bluestart: Apertura en frío
- Cartucho cerámico 38mm CLICK
- Caño extraíble con 1 función
- Latiguillos flexibles 3/8"



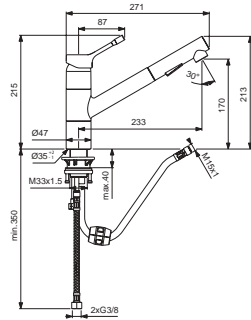

MONOMANDO COCINA CAÑO ALTO BLUESTART

Acabado: Cromo Brillo	Ref.	€/Ud.	Stock	Cant.
Giratorio y caño extraíble	BC297AA	220		6

- Tecnología Bluestart: Apertura en frío
- Cartucho cerámico 38mm CLICK
- Caño extraíble con 2 funciones
- Latiguillos flexibles 3/8"



COCINA CERAFLEX III

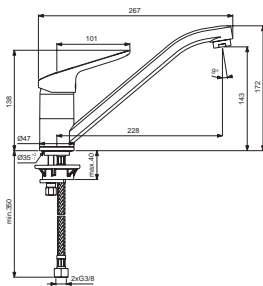

MONOMANDO COCINA BLUESTART

Acabado: Cromo Brillo	Ref.	€/Ud.	Stock	Cant.
Giratorio y Bluestart	BC129AA	100		6

- Tecnología Bluestart: Apertura en frío
- Cartucho cerámico 38mm
- Limitador de temperatura
- Latiguillos flexibles 3/8"

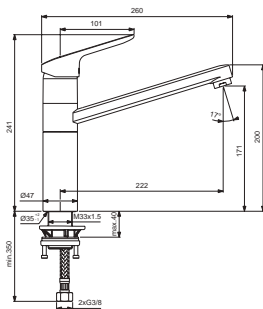

MONOMANDO COCINA CAÑO ALTO BLUESTART

Acabado: Cromo Brillo	Ref.	€/Ud.	Stock	Cant.
Giratorio y Bluestart	BC135AA	125		6

- Tecnología Bluestart: Apertura en frío
- Cartucho cerámico 38mm
- Limitador de temperatura
- Latiguillos flexibles 3/8"

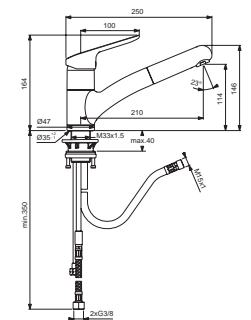

MONOMANDO COCINA CAÑO ALTO BLUESTART

Acabado: Cromo Brillo	Ref.	€/Ud.	Stock	Cant.
Giratorio, extraíble y Bluestart	BC143AA	140		6

- Tecnología Bluestart: Apertura en frío
- Cartucho cerámico 38mm
- Limitador de temperatura
- Latiguillos flexibles 3/8"





Caño extraíble
con 2 funciones

CERÁMICA

SANITARIOS

Funcionalidad e innovación a tu servicio,
con materiales de primera calidad para
vestir tu hogar.

SANITARIOS

146

SISTEMAS DE INSTALACIÓN

226



INNOVACIONES FUNCIONALES DE IDEAL STANDARD

AquaBlade® FLUSH TECHNOLOGY

La Tecnología AquaBlade® supera a todos los SANITARIOS existentes en términos de higiene.

Los SANITARIOS tradicionales dejan un área significativa del inodoro sin lavar en la parte posterior de la taza. La tecnología AquaBlade® está situado cerca de la parte superior del inodoro, de modo que limpia cada vez el 95% de la superficie.

La Tecnología AquaBlade® también es más higiénica que la de los SANITARIOS sin brida. Las bacterias se pueden albergar alrededor de la plataforma, además el agua a menudo puede salpicar sobre la taza durante el aclarado, lanzando partículas de bacterias al aire.

Con la Tecnología AquaBlade®, la presión del agua se optimiza y las suaves curvas del inodoro eliminan las bacterias dejando el inodoro libre de salpicaduras.





MÁS LIMPIO MÁS SILENCIOSO MÁS INTELIGENTE

MÁS LIMPIO:

LA TECNOLOGÍA AQUABLADE® ASEGURA QUE UN 95% DE LA SUPERFICIE QUEDE BIEN ENJUAGADA.

MÁS SILENCIOSO:

ESTÁ PROBADO QUE AQUABLADE® ES UN 25% MÁS SILENCIOSO QUE OTROS MODELOS EQUIVALENTES.

MÁS INTELIGENTE:

USO DEL AGUA MÁS EFECTIVO Y EFICIENTE COMPARADO CON DESCARGAS NORMALES.



AquaBlade®

FLUSH TECHNOLOGY

MÁS SILENCIOSO:

Está comprobado que AquaBlade® es un 25% más silencioso que Otros modelos equivalentes.

MÁS LIMPIO:

La tecnología AquaBlade® asegura que un 95% de la superficie quede bien enjuagada.

MÁS INTELIGENTE:

Uso del agua más efectivo y eficiente comparado con descargas normales.



LA REVOLUCIÓN EN EL BAÑO

“LA TECNOLOGÍA **AQUABLADE**® ES EL EQUIVALENTE EN EL BAÑO A LA INVENCION DEL MOTOR A REACCION”



Diseño más eficiente, el agua fluye desde la parte superior del inodoro aclarando el 95% de la superficie.



Integra un canal que crea una cascada de agua a presión, que fluye alrededor del inodoro creando dos fuertes chorros en la parte delantera. Estos se unen para formar una poderosa columna de agua que impulsa la materia sólida sin esfuerzo y optimiza la función de descarga o limpieza del inodoro.



La Tecnología Aquablade® ofrece un rendimiento de descarga superior en todo momento con menor ruido durante la misma.

SANITARIOS

ASIENTO Y TAPA DE INSTALACIÓN FÁCIL. FIJACIONES OCULTAS

Más fácil de instalar, menor mantenimiento, mejores beneficios, reducción del peso de la tapa considerablemente. Todo ello contribuye a una mejor posición a la hora de sentarse. Con un diseño ultra fino, más elegante, hará que realcen las piezas del cuarto de baño.



ORIFICIO PARA INSTALACIÓN LATERAL

TAPÓN LATERAL PARA INSERTAR EL LATIQUILLO

El orificio permanece perfectamente oculto con un tapón que mantiene la estética de la pieza sanitaria sin perder la funcionalidad.

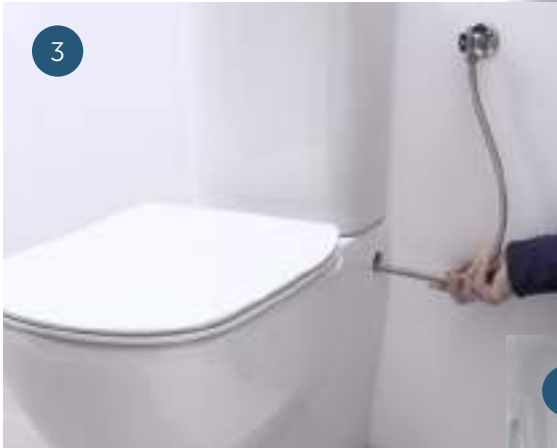
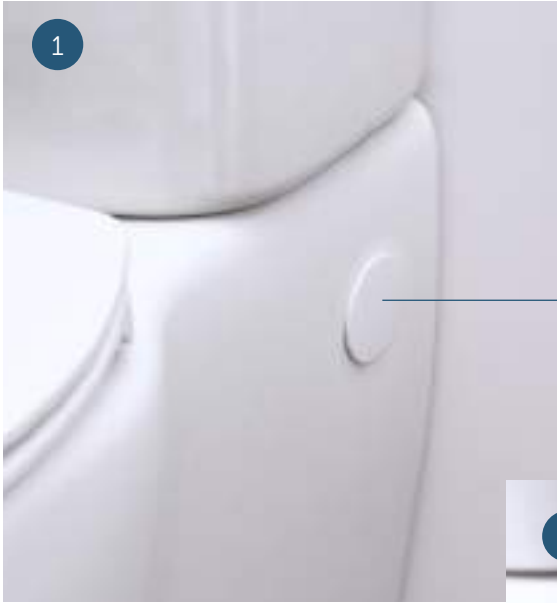

PARA CUALQUIER ALTURA DE LLAVE DE CORTE

Orificio lateral para cualquier altura de llave de corte. Reduce los costes y molestias al permitir la instalación del sanitario sin obra.

SANITARIOS

INFORMACIÓN TÉCNICA

CERÁMICA SANITARIOS

LEYENDA DE ICONOS



Doble descarga



Sin brida



Salida dual



Aqua Blade



4,5/3 Litros



Larga proyección



6/3 Litros



Corta proyección



Tapa fina



Elevado



Fijación oculta



Pack



Cierre amortiguado



Orificio alimentación lateral

















CERÁMICA

SANITARIOS

Pluralidad de formas y estilos unidos por un componente común: un diseño único.

CERÁMICA SANITARIOS

INODORO A PARED TANQUE BAJO	TONIC II	CONNECT AIR	CONNECT	CONNECT SPACE	
					
	425 €/Ud. Pág. 161	375 €/Ud. Pág. 175	350 €/Ud. Pág. 183	365 €/Ud. Pág. 191	
	<hr/>				
INODORO SUSPENDIDO	TONIC II	STRADA II	CONNECT AIR	CONNECT	CONNECT SPACE
					
		NOVEDAD			
	500 €/Ud. Pág. 160	375 €/Ud. Pág. 166	340 €/Ud. Pág. 174	250 €/Ud. Pág. 182	255 €/Ud. Pág. 190
	<hr/>				
INODORO A PARED TANQUE ALTO	TONIC II	STRADA II	CONNECT AIR	CONNECT	
					
		NOVEDAD			
	400 €/Ud. Pág. 160	265 €/Ud. Pág. 166	260 €/Ud. Pág. 174	220 €/Ud. Pág. 182	
<hr/>					
INODORO ABIERTO			CONNECT		
					
			350 €/Ud. Pág. 183		

TESI



385 €/Ud.
Pág. 205

ESEDRA



306 €/Ud.
Pág. 213

NOVEDAD

INODORO A
PARED TANQUE
BAJO

CONNECT FREEDOM



360 €/Ud.
Pág. 196

TESI



235 €/Ud.
Pág. 204

ESEDRA



185 €/Ud.
Pág. 188

NOVEDAD

EUROVIT



135 €/Ud.
Pág. 220

SIMPLICITY



135 €/Ud.
Pág. 224

NOVEDAD

INODORO
SUSPENDIDO

CONNECT FREEDOM



280 €/Ud.
Pág. 196

TESI



210 €/Ud.
Pág. 204

ESEDRA



180 €/Ud.
Pág. 188

NOVEDAD

INODORO A
PARED TANQUE
ALTO

CONNECT FREEDOM



465 €/Ud.
Pág. 197

TESI



325 €/Ud.
Pág. 205

ESEDRA



260 €/Ud.
Pág. 213

EUROVIT



155 €/Ud.
Pág. 221

INODORO
ABIERTO

CERÁMICA

SANITARIOS

CERÁMICA SANITARIOS



		TONIC II	CONNECT AIR	CONNECT	
INODORO A PARED TANQUE BAJO	INODORO	CORTA PROYECCIÓN		<input checked="" type="checkbox"/>	
		PROYECCIÓN	665mm	665mm	665mm
		SALIDA	DUAL	DUAL	DUAL
		DISTANCIA DESAGÜE A PARED	210mm	210mm	210mm
		CODO	No incl. opcional	No incl. opcional	No incl. opcional
	AQUABLADE	<input checked="" type="checkbox"/>	<input checked="" type="checkbox"/>	<input checked="" type="checkbox"/>	
	BRIDA NORMAL			<input checked="" type="checkbox"/>	
	PACK DISPONIBLE	Inodoro+Asiento			
	ORIFICIOS LATERALES			<input checked="" type="checkbox"/>	
	ASIENTO	ASIENTO FINO		<input checked="" type="checkbox"/>	<input checked="" type="checkbox"/>
ASIENTO ENVOLVENTE		<input checked="" type="checkbox"/>		<input checked="" type="checkbox"/>	
CIERRE AMORTIGUADO		<input checked="" type="checkbox"/>	<input checked="" type="checkbox"/>	<input checked="" type="checkbox"/>	
CIERRE NORMAL			<input checked="" type="checkbox"/>	<input checked="" type="checkbox"/>	
EXTRACCIÓN FÁCIL*		<input checked="" type="checkbox"/>	<input checked="" type="checkbox"/>	<input checked="" type="checkbox"/>	
TANQUE	ALIMENTACIÓN	Inferior	Inferior	Inferior/Lateral	
	LITROS DESCARGA	4,5/3L	4,5/3L	6/3L	
	ANGULAR	NO	NO	NO	
CERTIFICACIONES	BREEAM Y LEED	<input checked="" type="checkbox"/>	<input checked="" type="checkbox"/>		

* Asientos Soft



		CONNECT	CONNECT FREEDOM ELEVADO	TESI	
INODORO ABIERTO	INODORO	PROYECCIÓN	665 mm	650 mm	660 mm
		SALIDA	S/V- S/H	DUAL	DUAL
		DISTANCIA DESAGÜE A PARED	210mm	210mm	210mm
		CODO		Opcional	Opcional
		AQUABLADE	<input checked="" type="checkbox"/>		<input checked="" type="checkbox"/>
	BRIDA NORMAL	<input checked="" type="checkbox"/>	<input checked="" type="checkbox"/>		
	PACK DISPONIBLE				
	ASIENTO	ASIENTO FINO	<input checked="" type="checkbox"/>	<input checked="" type="checkbox"/>	<input checked="" type="checkbox"/>
		ASIENTO ENVOLVENTE	<input checked="" type="checkbox"/>	<input checked="" type="checkbox"/>	
		CIERRE AMORTIGUADO	<input checked="" type="checkbox"/>	<input checked="" type="checkbox"/>	<input checked="" type="checkbox"/>
CIERRE NORMAL		<input checked="" type="checkbox"/>	<input checked="" type="checkbox"/>	<input checked="" type="checkbox"/>	
EXTRACCIÓN FÁCIL*		<input checked="" type="checkbox"/>	<input checked="" type="checkbox"/>	<input checked="" type="checkbox"/>	
TANQUE	ALIMENTACIÓN	Inferior/Lateral	Inferior/Lateral	Inferior/Lateral	
	LITROS DESCARGA	6/3L	6/3L	4,5/3L	
	ANGULAR		<input checked="" type="checkbox"/>		
CERTIFICACIONES	BREEAM Y LEED			<input checked="" type="checkbox"/>	

* Asientos Soft



CONNECT SPACE	TESI	ESEDRA	
<input checked="" type="checkbox"/>		<input checked="" type="checkbox"/>	CORTA PROYECCIÓN
605mm	660mm	615mm	PROYECCIÓN
DUAL	DUAL	DUAL	SALIDA
210mm	210mm	210mm	DISTANCIA DESAGÜE A PARED
No incl. opcional	No incl. opcional	No incl. opcional	CODO
	<input checked="" type="checkbox"/>		AQUABLADE
<input checked="" type="checkbox"/>		<input checked="" type="checkbox"/>	BRIDA NORMAL
	COMPLETO	Inodoro+Asiento	PACK DISPONIBLE
	<input checked="" type="checkbox"/>	<input checked="" type="checkbox"/>	ORIFICIOS LATERALES
	<input checked="" type="checkbox"/>		ASIENTO FINO
<input checked="" type="checkbox"/>		<input checked="" type="checkbox"/>	ASIENTO ENVOLVENTE
<input checked="" type="checkbox"/>	<input checked="" type="checkbox"/>	<input checked="" type="checkbox"/>	CIERRE AMORTIGUADO
<input checked="" type="checkbox"/>	<input checked="" type="checkbox"/>		CIERRE NORMAL
<input checked="" type="checkbox"/>	<input checked="" type="checkbox"/>	<input checked="" type="checkbox"/>	EXTRACCIÓN FÁCIL
Inferior/Lateral	Inferior/Lateral	Inferior/Lateral	ALIMENTACIÓN
6/3L	4,5/3L	4,5/3L	LITROS DESCARGA
NO	NO	NO	ANGULAR
	<input checked="" type="checkbox"/>	<input checked="" type="checkbox"/>	BREEAM Y LEED



EUROVIT	
630 mm	PROYECCIÓN
S/V-S/H	SALIDA
210mm	DISTANCIA DESAGÜE A PARED
	CODO
	AQUABLADE
	BRIDA NORMAL
COMPLETO	PACK DISPONIBLE
	ASIENTO FINO
<input checked="" type="checkbox"/>	ASIENTO ENVOLVENTE
	CIERRE AMORTIGUADO
<input checked="" type="checkbox"/>	CIERRE NORMAL
	EXTRACCIÓN FÁCIL
Inferior/Lateral	ALIMENTACIÓN
6/3L	LITROS DESCARGA
	ANGULAR
	BREEAM Y LEED

CERÁMICA

SANITARIOS

CERÁMICA SANITARIOS



			TONIC II	STRADA II	CONNECT AIR	CONNECT
INODORO SUSPENDIDO	INODORO	CORTA PROYECCIÓN				
		PROYECCIÓN	560 mm	560 mm	550 mm	540 mm
		AQUABLADE	<input checked="" type="checkbox"/>	<input checked="" type="checkbox"/>	<input checked="" type="checkbox"/>	<input checked="" type="checkbox"/>
		BRIDA NORMAL				<input checked="" type="checkbox"/>
		SIN BRIDA/RIMLESS				
	FIJACIÓN OCULTA	<input checked="" type="checkbox"/>	<input checked="" type="checkbox"/>	<input checked="" type="checkbox"/>	<input checked="" type="checkbox"/>	
	PACK DISPONIBLE	Inodoro+Asiento		Inodoro+Asiento		
	ASIENTO FINO	<input checked="" type="checkbox"/>	<input checked="" type="checkbox"/>	<input checked="" type="checkbox"/>	<input checked="" type="checkbox"/>	
	ASIENTO	ASIENTO ENVOLVENTE				<input checked="" type="checkbox"/>
		CIERRE AMORTIGUADO	<input checked="" type="checkbox"/>	<input checked="" type="checkbox"/>	<input checked="" type="checkbox"/>	<input checked="" type="checkbox"/>
CIERRE NORMAL				<input checked="" type="checkbox"/>	<input checked="" type="checkbox"/>	
EXTRACCIÓN FÁCIL*		<input checked="" type="checkbox"/>	<input checked="" type="checkbox"/>	<input checked="" type="checkbox"/>	<input checked="" type="checkbox"/>	

* Asientos Soft



			TONIC II	STRADA II	CONNECT AIR	CONNECT
INODORO A PARED TANQUE ALTO	INODORO	PROYECCIÓN	565 mm	560 mm	545 mm	545 mm
		SALIDA	DUAL	DUAL	DUAL	DUAL
		DISTANCIA TOMAS	145 mm	140 mm	140 mm	100 - 160* mm
		CODO	Opcional	Opcional	Opcional	Opcional
		AQUABLADE	<input checked="" type="checkbox"/>	<input checked="" type="checkbox"/>	<input checked="" type="checkbox"/>	<input checked="" type="checkbox"/>
		BRIDA NORMAL				<input checked="" type="checkbox"/>
		FIJACIÓN OCULTA		<input checked="" type="checkbox"/>	<input checked="" type="checkbox"/>	
	PACK DISPONIBLE	Inodoro+Asiento		Inodoro+Asiento		
	ASIENTO	ASIENTO FINO	<input checked="" type="checkbox"/>	<input checked="" type="checkbox"/>	<input checked="" type="checkbox"/>	<input checked="" type="checkbox"/>
		ASIENTO ENVOLVENTE				<input checked="" type="checkbox"/>
CIERRE AMORTIGUADO		<input checked="" type="checkbox"/>	<input checked="" type="checkbox"/>	<input checked="" type="checkbox"/>	<input checked="" type="checkbox"/>	
EXTRACCIÓN FÁCIL**		<input checked="" type="checkbox"/>	<input checked="" type="checkbox"/>	<input checked="" type="checkbox"/>	<input checked="" type="checkbox"/>	

* Asientos Soft

* Con Aquablade













CONNECT SPACE	CONNECT FREEDOM ELEVADO	TESI	ESEDRA	EUROVIT	SIMPLICITY	
<input checked="" type="checkbox"/>						CORTA PROYECCIÓN
485 mm	545 mm	535 mm	545	520 mm	520	PROYECCIÓN
		<input checked="" type="checkbox"/>				AQUABLADE
<input checked="" type="checkbox"/>	<input checked="" type="checkbox"/>			<input checked="" type="checkbox"/>	<input checked="" type="checkbox"/>	BRIDA NORMAL
				<input checked="" type="checkbox"/>		SIN BRIDA/RIMLESS
<input checked="" type="checkbox"/>		<input checked="" type="checkbox"/>	<input checked="" type="checkbox"/>		<input checked="" type="checkbox"/>	FIJACIÓN OCULTA
		Inodoro+Asiento	Inodoro+Asiento			PACK DISPONIBLE
<input checked="" type="checkbox"/>	<input checked="" type="checkbox"/>	<input checked="" type="checkbox"/>				ASIENTO FINO
<input checked="" type="checkbox"/>	<input checked="" type="checkbox"/>		<input checked="" type="checkbox"/>	<input checked="" type="checkbox"/>	<input checked="" type="checkbox"/>	ASIENTO ENVOLVENTE
<input checked="" type="checkbox"/>	<input checked="" type="checkbox"/>	<input checked="" type="checkbox"/>	<input checked="" type="checkbox"/>	<input checked="" type="checkbox"/>	<input checked="" type="checkbox"/>	CIERRE AMORTIGUADO
<input checked="" type="checkbox"/>	<input checked="" type="checkbox"/>	<input checked="" type="checkbox"/>	<input checked="" type="checkbox"/>	<input checked="" type="checkbox"/>	<input checked="" type="checkbox"/>	CIERRE NORMAL
<input checked="" type="checkbox"/>	<input checked="" type="checkbox"/>	<input checked="" type="checkbox"/>	<input checked="" type="checkbox"/>			EXTRACCIÓN FÁCIL



CONNECT FREEDOM ELEVADO	TESI	ESEDRA	
545 mm	555 mm	540	PROYECCIÓN
DUAL	DUAL	DUAL	SALIDA
105 mm	140 mm	145	DISTANCIA TOMAS
Opcional	Opcional	Opcional	CODO
	<input checked="" type="checkbox"/>		AQUABLADE
<input checked="" type="checkbox"/>			BRIDA NORMAL
			FIJACIÓN OCULTA
	Inodoro+Asiento		PACK DISPONIBLE
<input checked="" type="checkbox"/>	<input checked="" type="checkbox"/>		ASIENTO FINO
<input checked="" type="checkbox"/>		<input checked="" type="checkbox"/>	ASIENTO ENVOLVENTE
<input checked="" type="checkbox"/>	<input checked="" type="checkbox"/>	<input checked="" type="checkbox"/>	CIERRE AMORTIGUADO
<input checked="" type="checkbox"/>	<input checked="" type="checkbox"/>	<input checked="" type="checkbox"/>	CIERRE NORMAL
<input checked="" type="checkbox"/>	<input checked="" type="checkbox"/>	<input checked="" type="checkbox"/>	EXTRACCIÓN FÁCIL

BIDÉS

		TONIC II	STRADA II	CONNECT AIR	CONNECT	CONNECT SPACE
	BIDÉ SUSPENDIDO					
		255 €/Ud. Pág. 160	230 €/Ud. Pág. 166	185 €/Ud. Pág. 174	155 €/Ud. Pág. 182	185 €/Ud. Pág. 190
		TONIC II	STRADA II	CONNECT AIR	CONNECT	CONNECT SPACE
BIDÉS	BIDÉ A PARED					
		245 €/Ud. Pág. 160	220 €/Ud. Pág. 166	155 €/Ud. Pág. 174	125 €/Ud. Pág. 182	130 €/Ud. Pág. 190
	BIDÉ A SUELO ABIERTO					

TESI



130 €/Ud.
Pág. 204

ESEDRA



115 €/Ud.
Pág. 212

EUROVIT



100 €/Ud.
Pág. 220

SIMPLICITY



75 €/Ud.
Pág. 224

BIDÉ
SUSPENDIDO

CONNECT FREEDOM



200 €/Ud.
Pág. 196

TESI



110 €/Ud.
Pág. 204

ESEDRA



90 €/Ud.
Pág. 212

BIDÉ A PARED

EUROVIT



55 €/Ud.
Pág. 220

BIDÉ A SUELO
ABIERTO

SANITARIOS

TONIC II

Su forma cónica y sus líneas curvas y envolventes le confieren una elegancia particular.



COMBINACIONES QUE SON
SENSIBLES A LAS SENSACIONES





Con tecnología
Aquablade®

- Más limpio
- Más silencioso
- Más inteligente

INFORMACIÓN TÉCNICA

TONIC II

Un diseño de inspiraciones geométricas que rompen con la monotonía del espacio y lo hacen ideal para cualquier baño.

Inodoro ganador del premio:



INODOROS Y BIDÉS



INODORO
SUSPENDIDO



INODORO A PARED
TANQUE ALTO



INODORO A PARED
TANQUE BAJO



BIDÉ
SUSPENDIDO



BIDÉ
A PARED

SANITARIOS TONIC II

CERÁMICA SANITARIOS



INODORO SUSPENDIDO

Acabado: Blanco Brillo	Ref.	€/Ud.	Stock	Cant.
Inodoro AQUABLADE Fijación oculta	K315801	415		6
Asiento y tapa envolvente con cierres amortiguado	K706501	85	<input checked="" type="checkbox"/>	6
PACK Inodoro + tapa envolvente con cierre amortiguado	K316701	500	<input checked="" type="checkbox"/>	6

Características técnicas

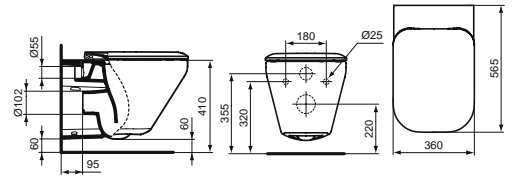

INODORO A PARED TANQUE ALTO

Acabado: Blanco Brillo	Ref.	€/Ud.	Stock	Cant.
Inodoro AQUABLADE* Fijación oculta y salida dual	K316201	315		6
Asiento y tapa envolvente con cierres amortiguado	K706501	85	<input checked="" type="checkbox"/>	6
PACK Inodoro + tapa envolvente con cierre amortiguado*	K317301	400	<input checked="" type="checkbox"/>	6

* Codo salida vertical no incluido

Opcional para hacer salida vertical, solicitar el código:

	Ref.	€/Ud.	Stock	Cant.
Codo 90° recto	WW965742	20	<input checked="" type="checkbox"/>	6

Características técnicas

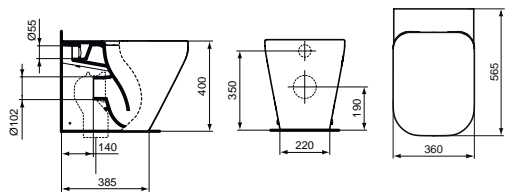

BIDÉ SUSPENDIDO

Acabado: Blanco Brillo	Ref.	€/Ud.	Stock	Cant.
Bidé Fijación Oculta	K523601	255	<input checked="" type="checkbox"/>	6

Características técnicas

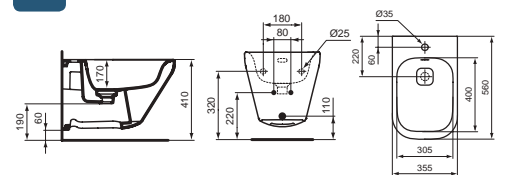

BIDÉ A PARED

Acabado: Blanco Brillo	Ref.	€/Ud.	Stock	Cant.
Bidé	K523801	245	<input checked="" type="checkbox"/>	6

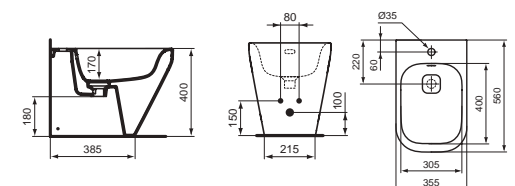



INODORO PARED TANQUE BAJO

Acabado: Blanco Brillo	Ref.	€/Ud.	Stock	Cant.
Inodoro AQUABLADE* Salida dual	K316001	340		6
Tanque 4,5/3L Tonic II A/I	K404901	242	☑	6
Asiento y tapa envolvente con cierres amortiguado	K706501	85	☑	6
PACK Inodoro + tapa envolvente con cierre amortiguado* (Tanque no incluido)	K316901	425	☑	6

* Codo salida vertical no incluido

Opcional para hacer salida vertical, solicitar el código:

	Ref.	€/Ud.	Stock	Cant.
Codo 90° recto	WW965742	20	☑	6

Características técnicas

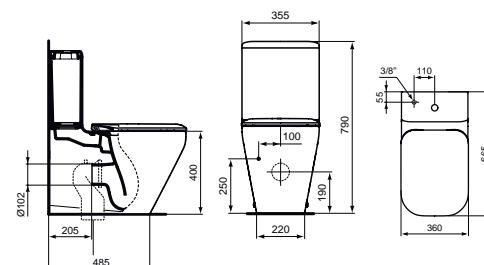

ACCESORIOS TONIC II



Acabado: Blanco Brillo	Ref.	Stock	Cant.	€/Ud.
Tanque 4,5/3L A/I	K404901	☑	6	242

Características técnicas



Acabado: Blanco Brillo	Ref.	Stock	Cant.	€/Ud.
Asiento y tapa envolvente con cierre amortiguado	K706501	☑	6	85

Características técnicas



REPUESTOS TONIC II



Acabado: Neutro	Ref.	Dónde se usa	€/Ud.
Kit fijación a suelo inodoro/ bidé	TT0257919	K316001 · K316901 · K316201 K317301 · K523801	5



Acabado: Neutro	Ref.	Dónde se usa	€/Ud.
Kit fijación oculta inodoro o bidé suspendidos	TT0299327	K315801 · K316701 · K523601	25



Acabado: Cromo brillo	Ref.	Dónde se usa	€/Ud.
Bisagras cierre amortiguado	TV110AA	K706501	60



Acabado: Blanco	Ref.	Dónde se usa	€/Ud.
Juego de topos asiento Tonic II	TV10767	K706501	10

SANITARIOS **NOVEDAD**

STRADA II

"Creo que nuestra nueva versión de la serie STRADA mantiene la esencia de la simplicidad. Un diseño más ligero y liviano es lo que se requerirá en los próximos años".

Robin Levien

Cofundador y director de diseño del Estudio Levien

CERÁMICA SANITARIOS



Asiento y tapa de extracción fácil.
Simplemente extraer el asiento hacia arriba para una perfecta limpieza.





INFORMACIÓN TÉCNICA **NOVEDAD**

STRADA II

Sus suaves líneas rectas le concede de una presencia que hace realzar los espacios modernos y vanguardistas.

CERÁMICA SANITARIOS

INODOROS Y BIDÉS



INODORO
SUSPENDIDO



INODORO A PARED
TANQUE ALTO



BIDÉ
SUSPENDIDO



BIDÉ
A PARED

SANITARIOS NOVEDAD STRADA II

CERÁMICA SANITARIOS



INODORO SUSPENDIDO

Acabado: Blanco Brillo	Ref.	€/Ud.	Stock	Cant.
Inodoro AQUABLADE Fijación oculta	T299701	375		6
Asiento y tapa fina con cierre amortiguado	T360101	85	<input checked="" type="checkbox"/>	6

Características técnicas

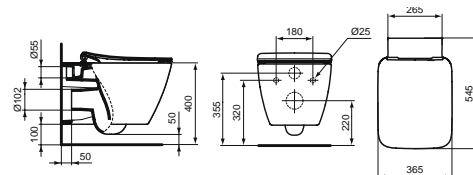

INODORO A PARED TANQUE ALTO

Acabado: Blanco Brillo	Ref.	€/Ud.	Stock	Cant.
Inodoro AQUABLADE* Fijación oculta y salida dual	T296801	265		6
Asiento y tapa fina con cierre amortiguado	T360101	85	<input checked="" type="checkbox"/>	6

Características técnicas



* Codo salida vertical no incluido

Opcional para hacer salida vertical, solicitar el código:

	Ref.	€/Ud.	Stock	Cant.
Codo 90° recto	WW965742	20	<input checked="" type="checkbox"/>	6

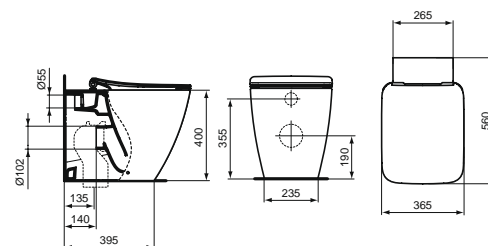

BIDÉ SUSPENDIDO

Acabado: Blanco Brillo	Ref.	€/Ud.	Stock	Cant.
Bidé fijación oculta	T297101	230		6

Características técnicas

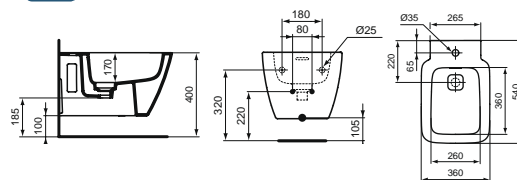

BIDÉ A PARED

Acabado: Blanco Brillo	Ref.	€/Ud.	Stock	Cant.
Bidé	T296901	220		6

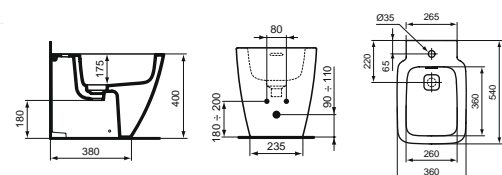

ACCESORIOS STRADA II



Acabado: Blanco Brillo	Ref.	Stock	Cant.	€/Ud.
Asiento y tapa con cierre amortiguado	T360101	<input checked="" type="checkbox"/>	6	85

Características técnicas



REPUESTOS STRADA II



Acabado: Neutro	Ref.	Dónde se usa	€/Ud.
Kit fijación a suelo inodoro/ bidé	TT0257919	T296801 · T296901	5
Acabado: Neutro	Ref.	Dónde se usa	€/Ud.
Kit fijación oculta inodoro o bidé suspendidos	TT0293851	T299701 · T297101	20
Acabado: Cromo brillo	Ref.	Dónde se usa	€/Ud.
Strada II anclaje soft	J4666BJ	T360101	25
Acabado: Cromo brillo	Ref.	Dónde se usa	€/Ud.
Strada II bisagras soft	TV716BJ	T360101	60
Acabado: Blanco	Ref.	Dónde se usa	€/Ud.
Juego de topes asiento Tonic II	EV46467	T360101	10

SANITARIOS

CONNECT AIR

CERÁMICA SANITARIOS

Un sinfín de oportunidades para crear un cuarto de baño ligero y moderno que desafíe las convenciones actuales.

Elegante, innovador y atemporal, su diseño es el resultado de la evolución constante.

DISEÑADO PARA
SATISFACER TODOS
LOS ESTILOS



Grifería no comercializada por Ideal Standard Iberia



Inodoro con doble descarga de 4.5 l/3 l
permite al usuario ahorrar agua por un
medio ambiente sostenible

SANITARIOS
CONNECT AIR

CERÁMICA SANITARIOS





Grifería no comercializada por Ideal Standard Iberia



Grifería no comercializada en Ideal Standard Iberia

INFORMACIÓN TÉCNICA

CONNECT AIR

De estilo moderno y atemporal, su diseño otorga un aire ligero a la composición del espacio.

Una solución integral que aporta una elegancia sin precedentes a nuestro cuarto de baño a través del confort y la funcionalidad

INODOROS Y BIDÉS



INODORO
SUSPENDIDO



INODORO A PARED
TANQUE ALTO



INODORO A PARED
TANQUE BAJO



BIDÉ
SUSPENDIDO



BIDÉ
A PARED

SANITARIOS CONNECT AIR

CERÁMICA SANITARIOS

INODORO SUSPENDIDO



Acabado: Blanco Brillo	Ref.	€/Ud.	Stock	Cant.
Inodoro AQUABLADE Fijación oculta	E005401	300		6
Asiento y tapa fina con cierre normal	K706501	40	<input checked="" type="checkbox"/>	6
Asiento y tapa fina con cierre amortiguado	E036601	75	<input checked="" type="checkbox"/>	6
PACK Inodoro + tapa fina con cierre normal	E008201	340	<input checked="" type="checkbox"/>	6
PACK Inodoro + tapa fina con cierre amortiguado	E008701	375	<input checked="" type="checkbox"/>	6

Características técnicas

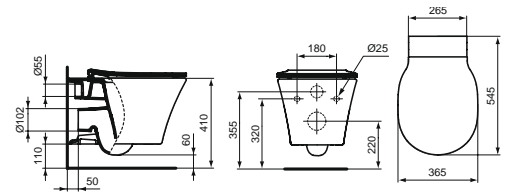

INODORO A PARED TANQUE ALTO



Acabado: Blanco Brillo	Ref.	€/Ud.	Stock	Cant.
Inodoro AQUABLADE* Fijación oculta y salida dual	E004201	220		6
Asiento y tapa fina con cierre normal	E036501	40	<input checked="" type="checkbox"/>	6
Asiento y tapa fina con cierre amortiguado	E036601	75	<input checked="" type="checkbox"/>	6
PACK Inodoro + tapa fina con cierre normal*	E004301	260	<input checked="" type="checkbox"/>	6
PACK Inodoro + tapa fina con cierre amortiguado*	E004901	295	<input checked="" type="checkbox"/>	6

Características técnicas

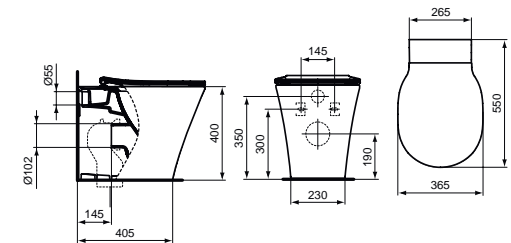

* Codo salida vertical no incluido

Opcional para hacer salida vertical, solicitar el código:

	Ref.	€/Ud.	Stock	Cant.
Codo 90° recto	WW965742	20	<input checked="" type="checkbox"/>	6

BIDÉ SUSPENDIDO



Acabado: Blanco Brillo	Ref.	€/Ud.	Stock	Cant.
Bidé Fijación Oculta	E026601	185	<input checked="" type="checkbox"/>	6

Características técnicas

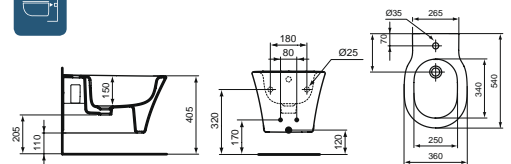

BIDÉ A PARED



Acabado: Blanco Brillo	Ref.	€/Ud.	Stock	Cant.
Bidé fijación oculta	E018001	155	<input checked="" type="checkbox"/>	6

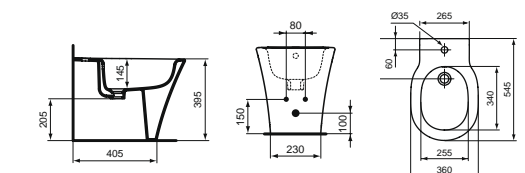



INODORO PARED TANQUE BAJO

Acabado: Blanco Brillo	Ref.	€/Ud.	Stock	Cant.
Inodoro AQUABLADE* salida dual	E013701	240	<input checked="" type="checkbox"/>	6
Tanque 4,5/3L A/I	E073401	145	<input checked="" type="checkbox"/>	6
Asiento y tapa fina con cierre normal	E036501	40	<input checked="" type="checkbox"/>	6
Asiento y tapa fina con cierre amortiguado	E036601	75	<input checked="" type="checkbox"/>	6

* Codo salida vertical no incluido

Opcional para hacer salida vertical, solicitar el código:

	Ref.	€/Ud.	Stock	Cant.
Codo 90º recto	WW965742	20	<input checked="" type="checkbox"/>	6

Características técnicas

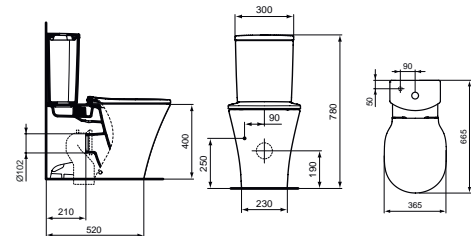

ACCESORIOS CONNECT AIR



Acabado: Blanco Brillo	Ref.	Stock	Cant.	€/Ud.
Tanque 4/3L A/I	E073401	<input checked="" type="checkbox"/>	6	145

Características técnicas



Acabado: Blanco Brillo	Ref.	Stock	Cant.	€/Ud.
Asiento y tapa fina con cierre normal	E036501	<input checked="" type="checkbox"/>	6	40
Asiento y tapa fina con cierre amortiguado	E036601	<input checked="" type="checkbox"/>	6	75

Características técnicas



REPUESTOS CONNECT AIR



Acabado: Neutro	Ref.	Dónde se usa	€/Ud.
Kit fijación a suelo para inodoro y bidé	TT0257919	E013701	5

Acabado: Neutro	Ref.	Dónde se usa	€/Ud.
Fijación para inodoro a suelo tanque alto	TT0293851	E004201 · E018001 E004301 · E004901	20

Acabado: Cromo Brillo	Ref.	Dónde se usa	€/Ud.
Kit fijación oculta inodoro / bidé suspendidos	TT0299598	E005401 · E026601 E008201 · E008701	25

Acabado: Neutro	Ref.	Dónde se usa	€/Ud.
Bisagras y anclaje caída normal	TV09767	E036501	25

Acabado: Blanco	Ref.	Dónde se usa	€/Ud.
Anclaje asiento soft	TV04767	E036601	30

Acabado: Blanco	Ref.	Dónde se usa	€/Ud.
Bisagras asiento soft	TV04867	E036601	45

Acabado: Blanco	Ref.	Dónde se usa	€/Ud.
Juego topes asiento fino	TV16567	E036501 · E036601	10

SANITARIOS

CONNECT

CERÁMICA SANITARIOS

Debido a que el estilo de cada uno es diferente, Connect nos ofrece gran flexibilidad. Es el lugar donde el diseño creativo reúne soluciones prácticas, esto significa que puede adaptar sus opciones, para satisfacer las necesidades individuales. Deja fluir la imaginación alrededor de sus curvas, bordes rectos y líneas suaves.



Elija el estilo que más se adapte a su gusto entre una gama de formas distintivas y construya su baño ideal.



Connect dispone de **fijaciones ocultas** que permiten un diseño más exclusivo en el cuarto de baño

UNA COLECCIÓN DE
MÚLTIPLES SOLUCIONES

SANITARIOS
CONNECT

LA SOLUCIÓN TOTAL PARA EL CUARTO DE BAÑO

CERÁMICA SANITARIOS



Con tecnología
Aquablade®

- Más limpio
- Más silencioso
- Más inteligente

Si usted se está planteando un espacio para cuarto de baño con estilo, Connect cumplirá todos sus deseos.

Elija el diseño de su cuarto de baño, a continuación, el inodoro, bidé y sus accesorios de moda y deje fluir las ideas, nosotros diseñamos para poder ofrecerle una solución completa.



Grifería no comercializada por Ideal Standard Iberia



Con orificios laterales para un rápida y fácil instalación. Ahorra tiempo y dinero en la instalación del inodoro

INFORMACIÓN TÉCNICA

CONNECT

Formas redondeadas y un diseño contemporáneo para hacer de tu baño un lugar divertido.

Su diseño permite adosarlo totalmente a la pared, por lo que la limpieza de nuestro cuarto de baño es mucho más sencilla.

INODOROS Y BIDÉS



INODORO
SUSPENDIDO



INODORO A PARED
TANQUE ALTO



INODORO
ABIERTO



INODORO A PARED
TANQUE BAJO



BIDÉ
SUSPENDIDO



BIDÉ
A PARED

SANITARIOS CONNECT

CERÁMICA SANITARIOS



INODORO SUSPENDIDO

Acabado: Blanco Brillo	Ref.	€/Ud.	Stock	Cant.
Inodoro Fijación Vista	E803501	210	<input checked="" type="checkbox"/>	6
Inodoro Fijación Oculta	E771801	235	<input checked="" type="checkbox"/>	6
Inodoro Fijación Oculta AQUABLADE	E047901	260	<input checked="" type="checkbox"/>	6
Asiento y tapa envolvente con cierre amortiguado	E712701	75	<input checked="" type="checkbox"/>	12
Asiento y tapa envolvente con cierre normal	E712801	40	<input checked="" type="checkbox"/>	12
Asiento y tapa fina con cierre amortiguado	E772401	75	<input checked="" type="checkbox"/>	12
Asiento y tapa fina con cierre normal	E772301	40	<input checked="" type="checkbox"/>	12

Características técnicas



Inodoro Fijación Vista

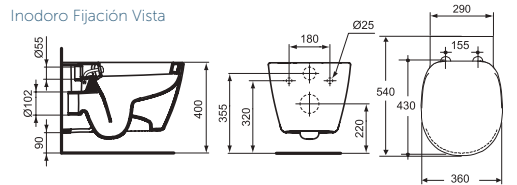

Inodoro Fijación Oculta

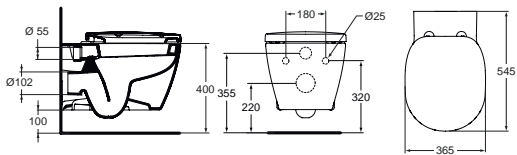

INODORO A PARED TANQUE ALTO

Acabado: Blanco Brillo	Ref.	€/Ud.	Stock	Cant.
Inodoro salida dual*	E803401	180	<input checked="" type="checkbox"/>	12
Inodoro AQUABLADE* Salida dual	E052401	190		12
Asiento y tapa envolvente con cierre amortiguado	E712701	75	<input checked="" type="checkbox"/>	12
Asiento y tapa envolvente con cierre normal	E712801	40	<input checked="" type="checkbox"/>	12
Asiento y tapa fina con cierre amortiguado	E772401	75	<input checked="" type="checkbox"/>	12
Asiento y tapa fina con cierre normal	E772301	40	<input checked="" type="checkbox"/>	12

Características técnicas



Inodoro salida dual

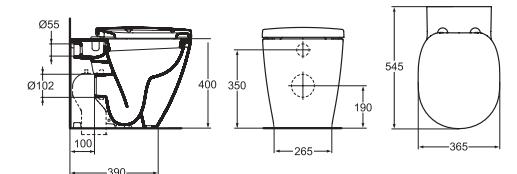

Inodoro Aquablade salida dual

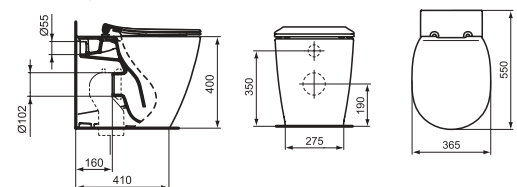

* Codo salida vertical no incluido

Opcional para hacer salida vertical, solicitar el código:

	Ref.	€/Ud.	Stock	Cant.
Codo 90° recto	WW965742	20	<input checked="" type="checkbox"/>	6



BIDÉ SUSPENDIDO

Acabado: Blanco Brillo	Ref.	€/Ud.	Stock	Cant.
Bidé Fijación Vista	E799701	155	<input checked="" type="checkbox"/>	6
Bidé Fijación Oculta	E772201	180	<input checked="" type="checkbox"/>	6

Características técnicas

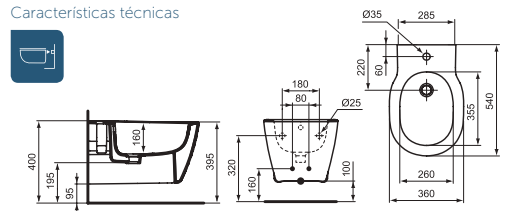

BIDÉ A PARED

Acabado: Blanco Brillo	Ref.	€/Ud.	Stock	Cant.
Bidé	E799501	125	<input checked="" type="checkbox"/>	6

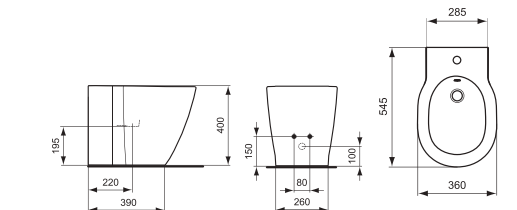



INODORO PARED TANQUE BAJO

Acabado: Blanco Brillo	Ref.	€/Ud.	Stock	Cant.
Inodoro salida dual*	E803701	185	<input checked="" type="checkbox"/>	12
Inodoro AQUABLADE* Salida dual	E039701	205	<input checked="" type="checkbox"/>	12
Tanque 6/3L Cúbico A/I	E797001	125	<input checked="" type="checkbox"/>	12
Tanque 6/3L Cúbico A/L	E797101	125	<input checked="" type="checkbox"/>	6
Asiento y tapa envolvente con cierre amortiguado	E712701	75	<input checked="" type="checkbox"/>	12
Asiento y tapa envolvente con cierre normal	E712801	40	<input checked="" type="checkbox"/>	12
Asiento y tapa fina con cierre amortiguado	E772401	75	<input checked="" type="checkbox"/>	12
Asiento y tapa fina con cierre normal	E772301	40	<input checked="" type="checkbox"/>	12

Características técnicas

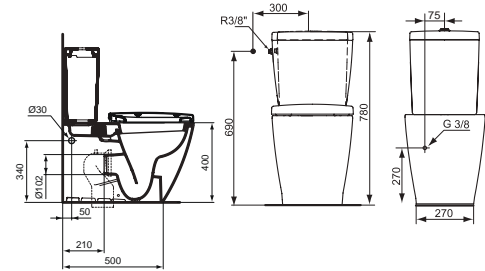

* Codo salida vertical no incluido

Opcional para hacer salida vertical, solicitar el código:

	Ref.	€/Ud.	Stock	Cant.
Codo 90° recto	WW965742	20	<input checked="" type="checkbox"/>	6

NOVEDAD

Orificios laterales para latiguillos

INODORO ABIERTO

Acabado: Blanco Brillo	Ref.	€/Ud.	Stock	Cant.
Inodoro AQUABLADE* Salida dual	E042901	190	<input checked="" type="checkbox"/>	12
Tanque 6/3L Cúbico A/I	E797001	125	<input checked="" type="checkbox"/>	12
Tanque 6/3L Cúbico A/L	E797101	125	<input checked="" type="checkbox"/>	6
Tanque 6/3L Angular A/I	E120201	125	<input checked="" type="checkbox"/>	6
Asiento y tapa envolvente con cierre amortiguado	E712701	75	<input checked="" type="checkbox"/>	12
Asiento y tapa envolvente con cierre normal	E712801	40	<input checked="" type="checkbox"/>	12
Asiento y tapa fina con cierre amortiguado	E772401	75	<input checked="" type="checkbox"/>	12
Asiento y tapa fina con cierre normal	E772301	40	<input checked="" type="checkbox"/>	12

Características técnicas



Esquema Aquablade con salida dual
para instalación con tanque normal

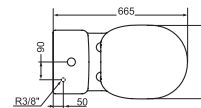
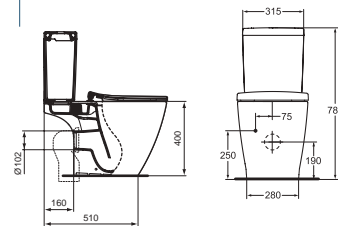

Esquema Aquablade con salida dual
para instalación con tanque angular

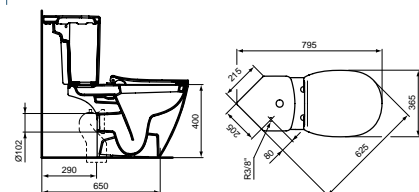

* Codo salida vertical no incluido

Opcional para hacer salida vertical, solicitar el código:

	Ref.	€/Ud.	Stock	Cant.
Codo 90° recto	WW965742	20	<input checked="" type="checkbox"/>	6



SANITARIOS ACCESORIOS CONNECT

CERÁMICA SANITARIOS



Acabado: Blanco Brillo	Ref.	Stock	Cant.	€/Ud.
Tanque Cúbico 6/3L A/I	E797001	<input checked="" type="checkbox"/>	12	125
Tanque Cúbico 6/3L A/L	E797101	<input checked="" type="checkbox"/>	6	125

Características técnicas



Acabado: Blanco Brillo	Ref.	Stock	Cant.	€/Ud.
Tanque angular 6/3L A/I	E120201		6	125

Características técnicas



IMPORTANTE: Se utiliza con inodoro abierto



Acabado: Blanco Brillo	Ref.	Stock	Cant.	€/Ud.
Asiento y tapa envolvente normal	E712801	<input checked="" type="checkbox"/>	12	40
Asiento y tapa envolvente con cierre amortiguado	E712701	<input checked="" type="checkbox"/>	12	75

Características técnicas



Acabado: Blanco Brillo	Ref.	Stock	Cant.	€/Ud.
Asiento y tapa fina normal	E772301	<input checked="" type="checkbox"/>	12	40
Asiento y tapa fina con cierre amortiguado	E772401	<input checked="" type="checkbox"/>	12	75

Características técnicas



REPUESTOS CONNECT



Acabado: Neutro	Ref.	Dónde se usa	€/Ud.
Kit fijación a suelo para inodoro y bidé	TT0257919	E803701 · E039701 · E042901 E803401 · E052401	5



Acabado: Neutro	Ref.	Dónde se usa	€/Ud.
Kit fijación oculta inodoro o bidé suspendidos	TT0299327	E047901 · E771801 · E772201	25



Acabado: Cromo Brillo	Ref.	Dónde se usa	€/Ud.
Bisagras y anclaje caída normal	EV286AA	E712801 · E772301	25



Acabado: Cromo Brillo	Ref.	Dónde se usa	€/Ud.
Anclaje asiento con cierre amortiguado	EV287AA	E712701 · E772401	25



Acabado: Blanco	Ref.	Dónde se usa	€/Ud.
Bisagra asiento con cierre amortiguado	T299067	E712701 · E772401	42



Acabado: Blanco	Ref.	Dónde se usa	€/Ud.
Topes asiento envolvente	K785401	E712701 · E712801	10



Acabado: Blanco	Ref.	Dónde se usa	€/Ud.
Topes asiento fino	TV16567	E772301 · E772401	10



SANITARIOS

CONNECT SPACE

Connect Space está diseñado específicamente para ayudarle a sacar el máximo provecho de todo su espacio, ya que su diseño ultra compacto se adapta a los espacios más pequeños.

CERÁMICA SANITARIOS



Grifería no comercializada por Ideal Standard Iberia

OPTIMIZA AL MÁXIMO TU ESPACIO



Inodoro de corta proyección,
optimiza el espacio al máximo.

60 cm



INFORMACIÓN TÉCNICA

CONNECT SPACE

La solución creativa para espacios reducidos que te permitirá sacar el máximo partido a tu cuarto de baño.

Un diseño moderno y elegante que cuenta, en la instalación de las series suspendidas, con sistema de fijación oculta.

INODOROS Y BIDÉS



INODORO
SUSPENDIDO



INODORO A PARED
TANQUE BAJO



BIDÉ
SUSPENDIDO



BIDÉ
A PARED

SANITARIOS

CONNECT SPACE

CERÁMICA SANITARIOS

INODORO SUSPENDIDO



Acabado: Blanco Brillo	Ref.	€/Ud.	Stock	Cant.
Inodoro Fijación Vista	E804601	215	<input checked="" type="checkbox"/>	12
Inodoro Fijación Oculta	E121701	245	<input checked="" type="checkbox"/>	12
Asiento y tapa envolvente corto con cierre normal	E129001	40	<input checked="" type="checkbox"/>	12
Asiento y tapa envolvente corto con cierre amortiguado	E129101	75	<input checked="" type="checkbox"/>	12
Asiento y tapa fina con cierre normal	E772301	40	<input checked="" type="checkbox"/>	12
Asiento y tapa fina con cierre amortiguado	E772401	75	<input checked="" type="checkbox"/>	12

Características técnicas

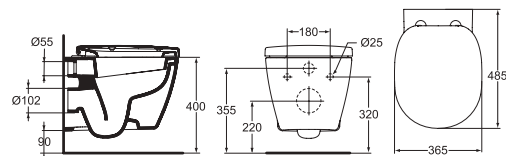

BIDÉ SUSPENDIDO



Acabado: Blanco Brillo	Ref.	€/Ud.	Stock	Cant.
Bidé Fijación Oculta	E119201	185	<input checked="" type="checkbox"/>	6

Características técnicas

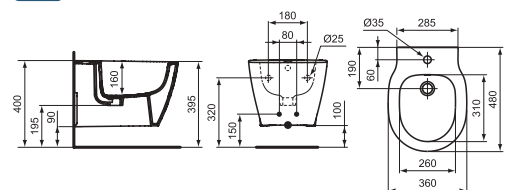

BIDÉ A PARED



Acabado: Blanco Brillo	Ref.	€/Ud.	Stock	Cant.
Bidé	E120001	130	<input checked="" type="checkbox"/>	6

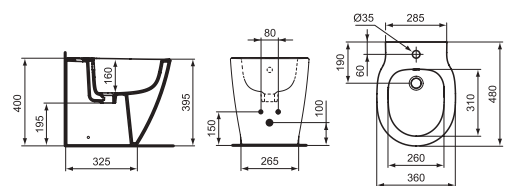

INODORO PARED TANQUE BAJO CORTA PROYECCIÓN



Inodoro corta proyección 60 cm

Acabado: Blanco Brillo	Ref.	€/Ud.	Stock	Cant.
Inodoro salida dual*	E119601	200	<input checked="" type="checkbox"/>	12
Tanque 6/3L Cúbico A/I	E797001	125	<input checked="" type="checkbox"/>	12
Tanque 6/3L Cúbico A/L	E797101	125	<input checked="" type="checkbox"/>	6
Asiento y tapa envolvente corto con cierre normal	E129001	40	<input checked="" type="checkbox"/>	12
Asiento y tapa envolvente corto con cierre amortiguado	E129101	75	<input checked="" type="checkbox"/>	12

* Codo salida vertical no incluido

Opcional para hacer salida vertical, solicitar el código:

	Ref.	€/Ud.	Stock	Cant.
Codo	T682067	20	<input checked="" type="checkbox"/>	6

Características técnicas

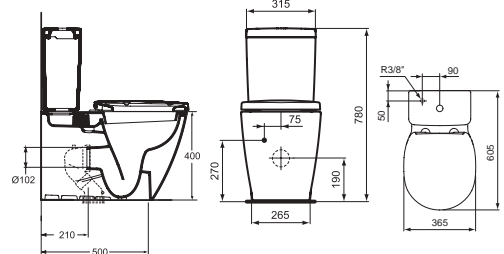

ACCESORIOS CONNECT SPACE



Acabado: Blanco Brillo	Ref.	Stock	Cant.	€/Ud.
Tanque Cúbico 6/3L A/I	E797001	<input checked="" type="checkbox"/>	12	125
Tanque Cúbico 6/3L A/L	E797101	<input checked="" type="checkbox"/>	6	125
Asiento y tapa envolvente corto con cierre amortiguado	E129101	<input checked="" type="checkbox"/>	12	75
Asiento y tapa envolvente corto con cierre normal	E129001	<input checked="" type="checkbox"/>	12	40
Asiento y tapa fina con cierre normal	E772301	<input checked="" type="checkbox"/>	12	40
Asiento y tapa fina con cierre amortiguado	E772401	<input checked="" type="checkbox"/>	12	75

Características técnicas



Características técnicas



Características técnicas



REPUESTOS CONNECT SPACE



Acabado: Neutro	Ref.	Dónde se usa	€/Ud.
Kit fijación a suelo para inodoro y bidé	TT0257919	E120001 · E119601	5
Acabado: Neutro	Ref.	Dónde se usa	€/Ud.
Kit fijación oculta inodoro o bidé suspendidos	TT0299327	E121701 · E119201	25
Acabado: Cromo Brillo	Ref.	Dónde se usa	€/Ud.
Bisagras y anclaje caída normal	EV286AA	E129001 · E772301	25
Acabado: Cromo Brillo	Ref.	Dónde se usa	€/Ud.
Anclaje asiento con cierre amortiguado	EV287AA	E129101 · E772401	25
Acabado: Blanco	Ref.	Dónde se usa	€/Ud.
Bisagra asiento con cierre amortiguado	T299067	E129101 · E772401	42
Acabado: Blanco	Ref.	Dónde se usa	€/Ud.
Topes asiento envolvente	K785401	E712301 · E712401	10
Acabado: Neutro	Ref.	Dónde se usa	€/Ud.
Topes asiento fino	TV16567	E772301 · E772401	10

SANITARIOS

CONNECT FREEDOM

Connect Freedom ha sido especialmente diseñado para adaptarse a cualquier espacio y necesidad del usuario. Connect Freedom proporciona confort a todos los usuarios que demandan mayor altura en el sanitario.

CERÁMICA SANITARIOS



Inodoro sin brida que facilita la limpieza del mismo y evita la aparición de bacterias y gérmenes



Inodoro sin brida que facilita la limpieza del mismo y evita la aparición de bacterias y gérmenes



46 cm

Inodoro y bidé diseñados para proporcionar al usuario **mayor altura y comodidad.**



46 cm

Inodoro y bidé diseñados para proporcionar al usuario **mayor altura y comodidad.**

INFORMACIÓN TÉCNICA

CONNECT FREEDOM

Inodoros elevados con más ergonomía de la taza, "accesibles" para que usted pueda elegir el producto que se adapte a sus necesidades.

INODOROS Y BIDÉS



INODORO SUSPENDIDO
ELEVADO



INODORO SUSPENDIDO
SIN BRIDA (RIMLESS)
PROYECCIÓN ESPECIAL 75CM



INODORO A PARED
TANQUE ALTO ELEVADO



INODORO A PARED
ABIERTO ELEVADO



BIDÉ A PARED
ELEVADO

SANITARIOS

CONNECT FREEDOM

CERÁMICA SANITARIOS



Inodoro elevado de 46 cm

INODORO SUSPENDIDO ELEVADO

Acabado: Blanco Brillo	Ref.	€/Ud.	Stock	Cant.
Inodoro ELEVADO	E607501	320		12
Asiento y tapa envolvente con cierre normal	E712801	40	<input checked="" type="checkbox"/>	12
Asiento y tapa envolvente con cierre amortiguado	E712701	75	<input checked="" type="checkbox"/>	12
Asiento y tapa fina con cierre normal	E772301	40	<input checked="" type="checkbox"/>	12
Asiento y tapa fina con cierre amortiguado	E772401	75	<input checked="" type="checkbox"/>	12

Características técnicas

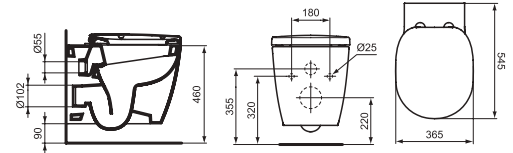

Inodoro proyección 70 cm

INODORO SUSPENDIDO PROJ. 75 CM SIN BRIDA (RIMLESS)

Acabado: Blanco Brillo	Ref.	€/Ud.	Stock	Cant.
Inodoro SIN BRIDA (Rimless)	E819501	330		6
Asiento y tapa envolvente Freedom con cierre normal	E822501	62		6
Asiento con cierre normal con proyección 75 cm	E822601	55		6

Características técnicas

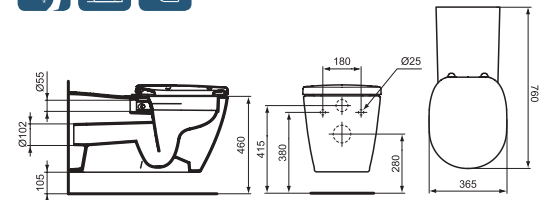

Inodoro elevado de 46 cm

INODORO A PARED TANQUE ALTO ELEVADO

Acabado: Blanco Brillo	Ref.	€/Ud.	Stock	Cant.
Inodoro salida dual ELEVADO*	E607201	240		12
Asiento y tapa envolvente con cierre normal	E712801	40	<input checked="" type="checkbox"/>	12
Asiento y tapa envolvente con cierre amortiguado	E712701	75	<input checked="" type="checkbox"/>	12
Asiento y tapa fina con cierre normal	E772301	40	<input checked="" type="checkbox"/>	12
Asiento y tapa fina con cierre amortiguado	E772401	75	<input checked="" type="checkbox"/>	12

Características técnicas

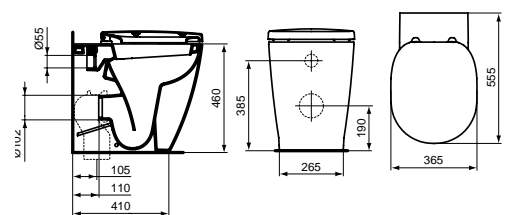

* Codo salida vertical no incluido

Opcional para hacer salida vertical, solicitar el código:

	Ref.	€/Ud.	Stock	Cant.
Codo 90° recto	WW965742	20	<input checked="" type="checkbox"/>	6



Inodoro elevado de 46 cm

BIDÉ A PARED ELEVADO

Acabado: Blanco Brillo	Ref.	€/Ud.	Stock	Cant.
BIDÉ A PARED ELEVADO	E607401	200		6

Características técnicas

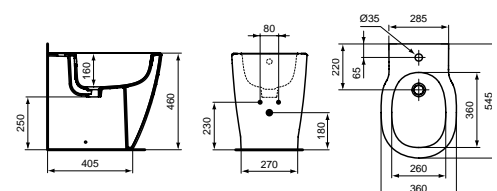

INODORO ABIERTO ELEVADO



Inodoro elevado de 46 cm

Acabado: Blanco Brillo	Ref.	€/Ud.	Stock	Cant.
Inodoro salida dual ELEVADO*	E607001	300		8
Tanque 6/3L cúbico A/I	E797001	125	<input checked="" type="checkbox"/>	12
Tanque 6/3L cúbico A/L	E797101	125	<input checked="" type="checkbox"/>	6
Tanque 6/3L angular A/I	E120201	125		6
Asiento y tapa normal	E712801	40	<input checked="" type="checkbox"/>	12
Asiento y tapa con cierre amortiguado	E712701	75	<input checked="" type="checkbox"/>	12
Asiento y tapa fina normal	E772301	40	<input checked="" type="checkbox"/>	12
Asiento y tapa fina con cierre amortiguado	E772401	75	<input checked="" type="checkbox"/>	12

* Codo salida vertical no incluido

Opcional para hacer salida vertical, solicitar el código:

	Ref.	€/Ud.	Stock	Cant.
Codo 90º recto	WW965742	20	<input checked="" type="checkbox"/>	6

Características técnicas

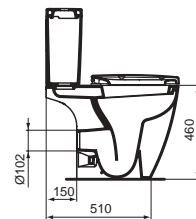

Esquema con salida dual para instalación con tanque cúbico

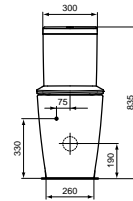

Esquema con salida dual para instalación con tanque angular

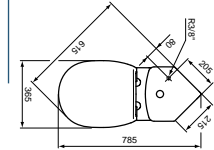
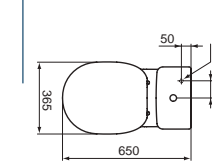

ACCESORIOS CONNECT FREEDOM



Acabado: Blanco Brillo	Ref.	Stock	Cant.	€/Ud.
Tanque Cúbico 6/3L A/I	E797001	<input checked="" type="checkbox"/>	12	125
Tanque Cúbico 6/3L A/L	E797101	<input checked="" type="checkbox"/>	6	125
Tanque 6/3L angular A/I	E120201		6	125
Acabado: Blanco Brillo	Ref.	Stock	Cant.	€/Ud.
Asiento y tapa envolvente Freedom cierre normal	E822501	<input checked="" type="checkbox"/>	12	65
Asiento cierre normal con proyección 75cm	E822601	<input checked="" type="checkbox"/>	12	55
Asiento envolvente con cierre amortiguado	E712701	<input checked="" type="checkbox"/>	12	75
Asiento envolvente con cierre normal	E712801	<input checked="" type="checkbox"/>	12	40
Asiento y tapa fina con cierre normal	E772301	<input checked="" type="checkbox"/>	12	40
Asiento y tapa fina con cierre amortiguado	E772401	<input checked="" type="checkbox"/>	12	75

Características técnicas



Características técnicas



REPUESTOS CONNECT FREEDOM



Acabado: Neutro	Ref.	Dónde se usa	€/Ud.
Kit fijación a suelo para inodoro y bidé	TT0257919	E120001 · E119601	5
Acabado: Cromo Brillo	Ref.	Dónde se usa	€/Ud.
Bisagras y anclaje caída normal	EV286AA	E121701 · E119201	25
Acabado: Cromo Brillo	Ref.	Dónde se usa	€/Ud.
Anclaje asiento con cierre amortiguado	EV287AA	E129001 · E772301	25
Acabado: Blanco	Ref.	Dónde se usa	€/Ud.
Bisagra asiento con cierre amortiguado	T299067	E129101 · E772401	42
Acabado: Blanco	Ref.	Dónde se usa	€/Ud.
Topes asiento envolvente	K785401	E129101 · E772401	10
Acabado: Blanco	Ref.	Dónde se usa	€/Ud.
Topes asiento fino	TV16567	E712301 · E712401	10

SANITARIOS

TESI

Lineas naturales y orgánicas pensadas para la configuración de un asiento cómodo y ergonómico pero sin renunciar a un carácter moderno.

CERÁMICA SANITARIOS



Pulsador no comercializado por Ideal Standard Iberia



Inodoro con orificios laterales para una rápida y fácil instalación. Ahorra tiempo y dinero en la instalación del inodoro

SANITARIOS TESI

CERÁMICA SANITARIOS



Mobiliario no comercializado por Ideal Standard Iberia





Con orificios laterales para una rápida y fácil instalación. Ahorra tiempo y dinero en la instalación del inodoro

INFORMACIÓN TÉCNICA

TESI

Líneas simples y recatadas que dan lugar a formas naturales y orgánicas.

Todo ello sin renunciar a un carácter moderno y su diseño funcional con la última tecnología.

INODOROS Y BIDÉS



INODORO
SUSPENDIDO



INODORO A PARED
TANQUE ALTO



INODORO
ABIERTO



INODORO A PARED
TANQUE BAJO



BIDÉ
SUSPENDIDO



BIDÉ
A PARED

SANITARIOS TESI

CERÁMICA SANITARIOS



INODORO SUSPENDIDO

Acabado: Blanco Brillo	Ref.	€/Ud.	Stock	Cant.
Inodoro AQUABLADE Fijación oculta	T007901	195	<input checked="" type="checkbox"/>	12
Asiento y tapa fina con cierre normal	T352801	40	<input checked="" type="checkbox"/>	12
Asiento y tapa fina con cierre amortiguado	T352701	75	<input checked="" type="checkbox"/>	12
PACK Inodoro + tapa fina con cierre normal	T354701	235	<input checked="" type="checkbox"/>	12
PACK Inodoro + tapa con cierre amortiguado	T354601	270	<input checked="" type="checkbox"/>	12

Características técnicas

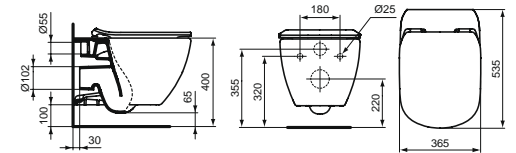

INODORO A PARED TANQUE ALTO



Acabado: Blanco Brillo	Ref.	€/Ud.	Stock	Cant.
Inodoro AQUABLADE* Salida dual	T007701	170		6
Asiento y tapa fina con cierre normal	T352801	40	<input checked="" type="checkbox"/>	12
Asiento y tapa fina con cierre amortiguado	T352701	75	<input checked="" type="checkbox"/>	12
PACK Inodoro + tapa fina con cierre normal*	T353701	210	<input checked="" type="checkbox"/>	12
PACK Inodoro + tapa con cierre amortiguado*	T353601	245	<input checked="" type="checkbox"/>	12

Características técnicas

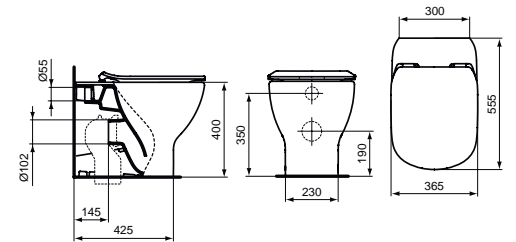

* Codo salida vertical no incluido

Opcional para hacer salida vertical, solicitar el código:

	Ref.	€/Ud.	Stock	Cant.
Codo 90° recto	WW965742	20	<input checked="" type="checkbox"/>	6

BIDÉ SUSPENDIDO



Acabado: Blanco Brillo	Ref.	€/Ud.	Stock	Cant.
Bidé fijación oculta	T355201	130	<input checked="" type="checkbox"/>	6

Características técnicas

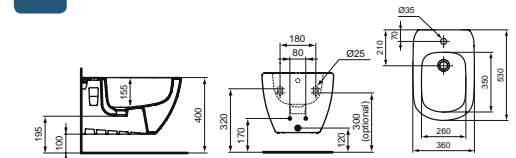

BIDÉ A PARED



Acabado: Blanco Brillo	Ref.	€/Ud.	Stock	Cant.
Bidé	T354001	110	<input checked="" type="checkbox"/>	6

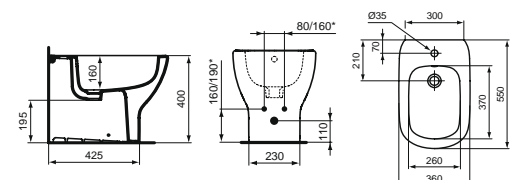



NOVEDAD

Orificios laterales para latiguillos

INODORO PARED TANQUE BAJO

Acabado: Blanco Brillo	Ref.	€/Ud.	Stock	Cant.
Inodoro AQUABLADE* Salida dual	T008201	180	<input checked="" type="checkbox"/>	12
Tanque 4,5/3L A/L	T262601	110	<input checked="" type="checkbox"/>	12
Tanque 4,5/3L A/I	T356801	110	<input checked="" type="checkbox"/>	12
Asiento y tapa fina normal	T352801	40	<input checked="" type="checkbox"/>	12
Asiento y tapa fina con cierre amortiguado	T352701	75	<input checked="" type="checkbox"/>	12
PACK INODORO TESI Inodoro + tanque + tapa con cierre amortiguado + codo	T371701	385	<input checked="" type="checkbox"/>	12

* Codo salida vertical no incluido

Opcional para hacer salida vertical, solicitar el código:

	Ref.	€/Ud.	Stock	Cant.
Codo 90° recto	WW965742	20	<input checked="" type="checkbox"/>	6

Características técnicas

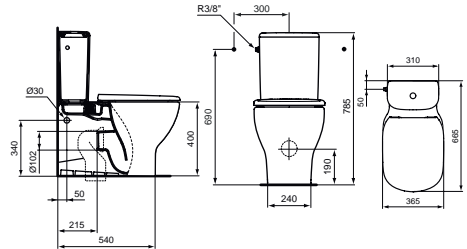

NOVEDAD



INODORO ABIERTO

Acabado: Blanco Brillo	Ref.	€/Ud.	Stock	Cant.
Inodoro AQUABLADE* Salida dual	T008701	175		12
Tanque 4,5/3L A/L	T262601	110	<input checked="" type="checkbox"/>	12
Tanque 4,5/3L A/I	T356801	110	<input checked="" type="checkbox"/>	12
Asiento y tapa fina normal	T352801	40	<input checked="" type="checkbox"/>	12
Asiento y tapa fina con cierre amortiguado	T352701	75	<input checked="" type="checkbox"/>	12

* Codo salida vertical no incluido

Opcional para hacer salida vertical, solicitar el código:

	Ref.	€/Ud.	Stock	Cant.
Codo 90° recto	WW965742	20	<input checked="" type="checkbox"/>	6

Características técnicas

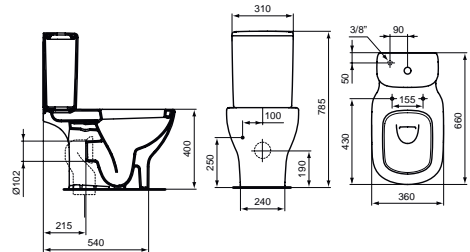

SANITARIOS ACCESORIOS TESI

CERÁMICA SANITARIOS



Acabado: Blanco Brillo	Ref.	Stock	Cant.	€/Ud.
Tanque 4,5/3L A/L	T262601	<input checked="" type="checkbox"/>	12	110
Tanque 4,5/3L A/I	T356801	<input checked="" type="checkbox"/>	12	110

Características técnicas



Acabado: Blanco Brillo	Ref.	Stock	Cant.	€/Ud.
Asiento y tapa fina con cierre normal	T352801	<input checked="" type="checkbox"/>	12	40
Asiento y tapa fina con cierre amortiguado	T352701	<input checked="" type="checkbox"/>	12	75

Características técnicas



REPUESTOS TESI



Acabado: Neutro	Ref.	Dónde se usa	€/Ud.
Kit fijación a suelo para inodoro y bidé	TT029931	T007701 - T353701 T353601 - T008201 T008701 - T354001	5



Acabado: Neutro	Ref.	Dónde se usa	€/Ud.
Kit fijación oculta inodoro / bidé suspendidos TESI	TT0299598	T007901 - T355201 T354701 - T354601	25



Acabado: Cromo Brillo	Ref.	Dónde se usa	€/Ud.
Bisagras y anclaje caída normal	TV09767	T352801	25



Acabado: Blanco	Ref.	Dónde se usa	€/Ud.
Anclaje asiento con cierre amortiguado	TV04767	T352701	30



Acabado: Blanco	Ref.	Dónde se usa	€/Ud.
Bisagra asiento con cierre amortiguado	TV04867	T352701	45



Acabado: Neutro	Ref.	Dónde se usa	€/Ud.
Topes asiento fino	TV04967	T352801 - T352701	10

LA REVOLUCIÓN EN EL BAÑO



AquaBlade®
FLUSH TECHNOLOGY

MÁS SILENCIOSO:

Está comprobado que AquaBlade® es un 25% más silencioso que otros modelos equivalentes.

MÁS LIMPIO:

La tecnología AquaBlade® asegura que un 95% de la superficie quede bien enjuagada.

MÁS INTELIGENTE:

Uso del agua más efectivo y eficiente comparado con descargas normales.

SANITARIOS **NOVEDAD**

ESEDRA

Esedra presenta un diseño que fusiona calidad, sobriedad y sencillez con un toque de armonía.

CERÁMICA SANITARIOS



61 cm
**Inodoro de corta
proyección**, optimiza
el espacio al máximo.





Inodoro con orificios laterales para un rápida y fácil instalación. Ahorra tiempo y dinero en la instalación del inodoro

INFORMACIÓN TÉCNICA **NOVEDAD**

ESEDRA

Sus formas armoniosas crean una atmósfera elegante, moderna y agradable.

INODOROS Y BIDÉS



INODORO
SUSPENDIDO



INODORO A PARED
TANQUE ALTO



INODORO ABIERTO
TANQUE BAJO



INODORO A PARED
TANQUE BAJO



BIDÉ
SUSPENDIDO



BIDÉ
A PARED

INODORO PARED TANQUE BAJO CORTA PROYECCIÓN



Inodoro corta proyección 61 cm

NOVEDAD

Orificios laterales para latiguillos

Acabado: Blanco Brillo	Ref.	€/Ud.	Stock	Cant.
Inodoro salida dual*	T282001	166	<input checked="" type="checkbox"/>	12
Tanque 4,5/3L A/I	T282801	100	<input checked="" type="checkbox"/>	12
Tanque 4,5/3L A/L	T323601	100		6
Asiento y tapa corta proyección cierre normal	T318601	40	<input checked="" type="checkbox"/>	12
Asiento y tapa corta proyección con cierre amortiguado	T318301	75	<input checked="" type="checkbox"/>	12
* Codo salida vertical no incluido				
Opcional para hacer salida vertical, solicitar el código:				
	Ref.	€/Ud.	Stock	Cant.
Codo 90° con desplazamiento de 60 cm	T682067	20	<input checked="" type="checkbox"/>	6

Características técnicas

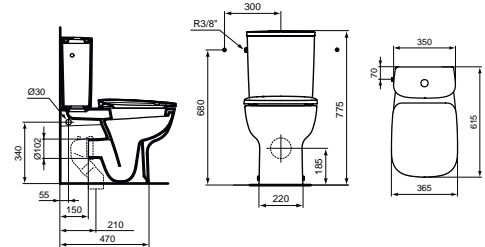

INODORO ABIERTO TANQUE BAJO



Acabado: Blanco Brillo	Ref.	€/Ud.	Stock	Cant.
Inodoro abierto	T283401	120	<input checked="" type="checkbox"/>	6
Tanque 4,5/3L A/I	T282801	100	<input checked="" type="checkbox"/>	12
Tanque 4,5/3L A/L	T323601	100		12
Asiento y tapa corta proyección cierre normal	T318601	40	<input checked="" type="checkbox"/>	12
Asiento y tapa corta proyección con cierre amortiguado	T318301	75	<input checked="" type="checkbox"/>	12
* Codo salida vertical no incluido				
Opcional para hacer salida vertical, solicitar el código:				
	Ref.	€/Ud.	Stock	Cant.
Codo 90° con desplazamiento de 60 cm	T682067	20	<input checked="" type="checkbox"/>	6

Características técnicas

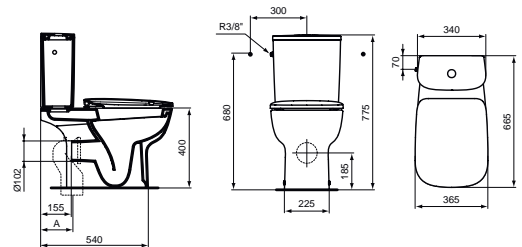

ACCESORIOS ESEDRA



Acabado: Blanco Brillo	Ref.	Stock	Cant.	€/Ud.
Tanque 4,5/3L A/I	T282801	<input checked="" type="checkbox"/>	12	100
Tanque 4,5/3L A/L	T323601		12	100
Asiento y tapa envolvente con cierre normal	T318201	<input checked="" type="checkbox"/>	12	40
Asiento y tapa envolvente con cierre amortiguado	T318101	<input checked="" type="checkbox"/>	12	75
Asiento y tapa corta proyección cierre normal	T318601	<input checked="" type="checkbox"/>	12	40
Asiento y tapa corta proyección cierre amortiguado	T318301	<input checked="" type="checkbox"/>	12	75

Características técnicas



Características técnicas



REPUESTOS ESEDRA



Acabado: Neutro	Ref.	Dónde se usa	€/Ud.
Kit fijación a suelo para inodoro	TT0257919	T282001 · 7281201 · T300801 T300901 · T281301	5
Acabado: Neutro	Ref.	Dónde se usa	€/Ud.
Kit fijación oculta inodoro / bidé suspendidos	TT0299598	T281401 · T278601 T278701 · T281501	25
Acabado: Cromo Brillo	Ref.	Dónde se usa	€/Ud.
Bisagras y anclaje caída normal	TV09767	T318101 · T318601	25
Acabado: Cromo brillo	Ref.	Dónde se usa	€/Ud.
Anclaje asiento con cierre amortiguado	TV04767	T318201 · T318301	30
Acabado: Blanco	Ref.	Dónde se usa	€/Ud.
Bisagra asiento con cierre amortiguado	TV04867	T318201 · T318301	45
Acabado: Blanco	Ref.	Dónde se usa	€/Ud.
Topes asiento fino	TV64267	T318101 · T318201 T318301 · T318601	10



SANITARIOS

EUROVIT

La versatilidad al servicio
de tus necesidades.

CERÁMICA SANITARIOS



Accesorios, placa pulsadora y grifería no comercializada por ideal Standard Ibería



NOVEDAD

Inodoro sin brida
para una fácil limpieza





INFORMACIÓN TÉCNICA

EUROVIT

Equilibrio perfecto como resultado de la combinación de formas redondas y rectangulares.

Sus líneas armoniosas los hacen muy atractivos, además de ofrecer un plus de seguridad y confort adicional en el baño

INODOROS Y BIDÉS

INODORO
SUSPENDIDOINODORO
ABIERTOBIDÉ
SUSPENDIDOBIDÉ
A SUELO

SANITARIOS EUROVIT

CERÁMICA SANITARIOS

INODORO SUSPENDIDO



Acabado: Blanco Brillo	Ref.	€/Ud.	Stock	Cant.
Inodoro suspendido	W740601	110		12
Asiento y tapa con cierre normal	W302601	25		12
Asiento y tapa con cierre amortiguado	W303001	50		12

Características técnicas

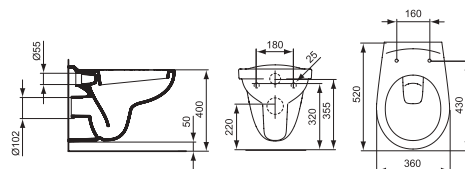

INODORO SUSPENDIDO SIN BRIDA (RIMLESS)



NOVEDAD

Acabado: Blanco Brillo	Ref.	€/Ud.	Stock	Cant.
Inodoro suspendido sin brida	K881001	120		12
Asiento y tapa con cierre normal	W302601	25		12
Asiento y tapa con cierre amortiguado	W303001	50		12

Características técnicas

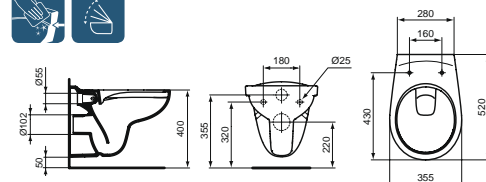

BIDÉ SUSPENDIDO



Acabado: Blanco Brillo	Ref.	€/Ud.	Stock	Cant.
Bidé	V493201	100		6

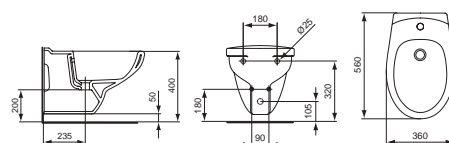

BIDÉ A PARED



Acabado: Blanco Brillo	Ref.	€/Ud.	Stock	Cant.
Bidé*	E877401	55	<input checked="" type="checkbox"/>	6

*Se suministra sin juego de fijaciones

Opcional:

Juego fijaciones Bidé	J118067	5	<input checked="" type="checkbox"/>	6
-----------------------	----------------	----------	-------------------------------------	---

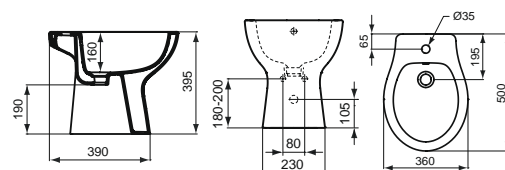

PACKS INODOROS



Acabado: Blanco Brillo	Ref.	€/Ud.	Stock	Cant.
PACK Eurovit S/V A/I	V337201	155	<input checked="" type="checkbox"/>	12
PACK Eurovit S/V A/L	V002001	155	<input checked="" type="checkbox"/>	12
PACK Eurovit S/H A/I	V337001	155	<input checked="" type="checkbox"/>	12
PACK Eurovit S/H A/L	V002101	155	<input checked="" type="checkbox"/>	12

Características técnicas

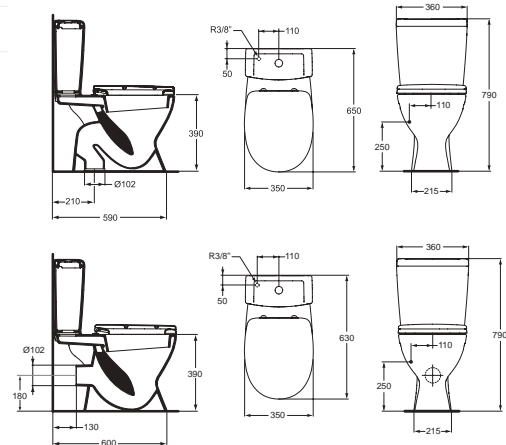

ACCESORIOS EUROVIT



Acabado: Blanco Brillo	Ref.	Stock	Cant.	€/Ud.
Asiento y tapa con cierre normal	W302601	<input checked="" type="checkbox"/>	12	25
Asiento y tapa con cierre amortiguado	W303001	<input checked="" type="checkbox"/>	6	50

Características técnicas



REPUESTOS EUROVIT



Acabado: Neutro	Ref.	Dónde se usa	€/Ud.
Kit fijación a suelo para inodoro	TT0257919	V337201 · V002001 V337001 · V002101	5
Acabado: Neutro	Ref.	Dónde se usa	€/Ud.
Kit fijación vertical a suelo	J118067	E877401	5
Acabado: Cromo Brillo	Ref.	Dónde se usa	€/Ud.
Bisagra asiento Eurovit normal	K7310BJ	W302601	20
Acabado: Blanco	Ref.	Dónde se usa	€/Ud.
Bisagra asiento Eurovit cierre amortiguado	W303601	W303001	28
Acabado: Blanco	Ref.	Dónde se usa	€/Ud.
Topes asiento envolvente	K785401	E712701 · E712801	10



INFORMACIÓN TÉCNICA **NOVEDAD**

SIMPLICITY

La simplicidad de sus líneas y estilo minimalista permiten la máxima adaptabilidad sin renunciar al diseño. Máximo Confort como resultado de la combinación de líneas elegantes y funcionales. Calidad y diseño al servicio del bienestar.

CERÁMICA SANITARIOS

INODOROS Y BIDÉS



INODORO
SUSPENDIDO



BIDÉ
SUSPENDIDO

SANITARIOS NOVEDAD

SIMPLICITY

CERÁMICA SANITARIOS



INODORO SUSPENDIDO

Acabado: Blanco Brillo	Ref.	€/Ud.	Stock	Cant.
Inodoro suspendido	E876901	100		12
Asiento y tapa envolvente con cierre normal	E131701	25		12
Asiento y tapa envolvente con cierre amortiguado	E131801	50		12

Características técnicas

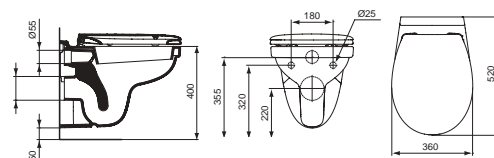

BIDÉ SUSPENDIDO

Acabado: Blanco Brillo	Ref.	€/Ud.	Stock	Cant.
Bidé	E877301	75		6

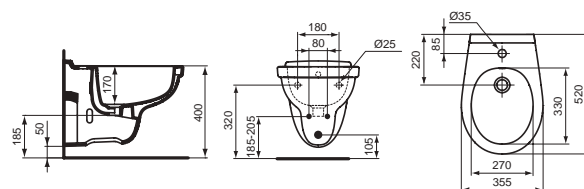

ACCESORIOS SIMPLICITY



Acabado: Blanco Brillo	Ref.	Stock	Cant.	€/Ud.
Asiento y tapa cierre normal	E131701	<input checked="" type="checkbox"/>	12	25
Asiento y tapa cierre amortiguado	E131801	<input checked="" type="checkbox"/>	12	50

Características técnicas



REPUESTOS



Acabado: Cromo Brillo	Ref.	Dónde se usa	€/Ud.
Bisagra asiento Simplicity normal	K7310BJ	W302601	28
Acabado: Blanco	Ref.	Dónde se usa	€/Ud.
Bisagra asiento Simplicity cierre amortiguado	W303601	W303001	28
Acabado: Blanco	Ref.	Dónde se usa	€/Ud.
Topes asiento envolvente	K785401	E131601 · E131801	10





INFORMACIÓN TÉCNICA

SISTEMAS DE INSTALACIÓN

El corazón de nuestros diseños se encuentra unido a la tecnología que hace posible su funcionalidad. Innovación perfectamente integrada en la estancia para conservar la apariencia estética deseada.

SANITARIOS SISTEMAS DE INSTALACIÓN

CERÁMICA SANITARIOS

SISTEMA INSTALACIÓN MECÁNICO INODOROS



Acabado: Neutro	Ref.	€/Ud.	Stock	Cant.
Sistema instalación mecánico inodoro suspendido	C6612AA	225		12

Descripción

- Descarga Dual 3/6-7,5 L
- Compatible con todos los SANITARIOS suspendidos
- Espesor de 120-170 mm
- Empotrada en la pared o en la placa de yeso
- Estructura probada para cargas de 400 kg
- Codo de desagüe ajustable en profundidad
- Instalación rápida y sencilla con sistema de ajuste rápido
- Altura ajustable de 0 a 200 mm

Incluidos

- Red para una mayor adhesión al mortero
- Material de fijación del inodoro
- Material de fijación de la estructura
- Conexión de entrada y de salida del inodoro
- Codo de desagüe y adaptador Ø 90/110
- Válvula de cierre G 1/2"

Accesorios	Ref.	P.€	Stock	Cant.
Kit aislamiento acústico inodoro/bidé suspendido	T604900	15		12

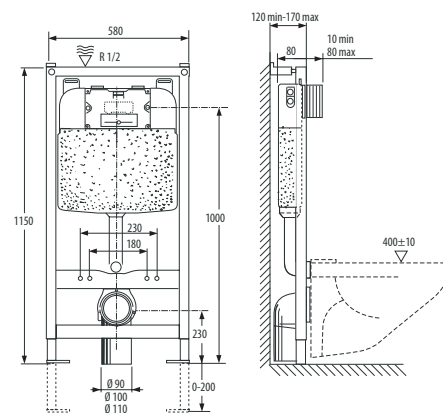

PLACAS MECÁNICAS

MODELO SLIM:

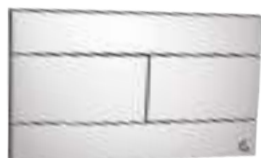

Acabado	Ref.	€/Ud.	Stock	Cant.
 Slim cromo	VV659044	60		12
 Slim cromo mate	VV659046	65		12
 Slim negro	VV659055	100		12

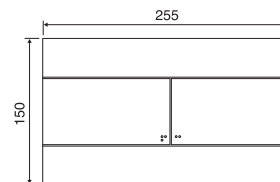

MODELO METAL:



Acabado	Ref.	€/Ud.	Stock	Cant.
 Metal dual cromo	VV656004	130		12
 Metal dual cromo mate	VV656006	145		12

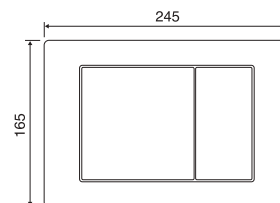

MODELO RIVER:



Acabado	Ref.	€/Ud.	Stock	Cant.
 River dual blanco	VV638581	30		12
 River dual cromo	VV638584	45		12
 River dual cromo mate	VV638586	50		12

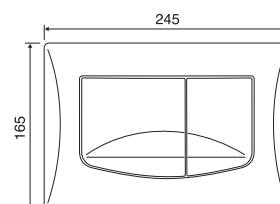

PLACAS NEUMÁTICAS



MODELO KARISMA:

Acabado		Ref.	€/Ud.	Stock	Cant.
	Karisma blanco	VV641001	45		12
	Karisma cromo	E4465AA	60		12
	Karisma cromo mate	E4465GN	65		12
	Karisma negro	VV641015	105		12

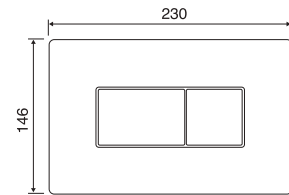

* Para instalar la placa neumática Karisma es necesario pedir el kit neumático



KIT CONVERSIÓN NEUMÁTICO

Acabado: Neutro		Ref.	€/Ud.	Stock	Cant.
	Kit conversión neumático	C6621NU	35		12

REPUESTOS MECANISMO EMPOTRADO

Acabado: Neutro		Ref.	€/Ud.	Stock	Cant.
	Mecanismo de alimentación	EV10667	35		N/A
	Mecanismo de descarga	C002099	35		N/A

SANITARIOS SISTEMAS DE INSTALACIÓN

CERÁMICA SANITARIOS

SISTEMA INSTALACIÓN MECÁNICO INODOROS



Acabado: Neutro	Ref.	€/Ud.	Stock	Cant.
Cisterna empotrada con estructura	W309967	175		12

Descripción

Formado por un marco de chapa galvanizada para su uso en paredes de mampostería, destinado a la instalación rápida y segura de piezas de baño suspendidas.

- Descarga Dual 3/6 Litros

Incluidos

- Cubierta anticondensación
- Válvula cierre G 1/2
- Conexión de entrada y salida del inodoro
- Codo de desagüe incluido

* Se tiene que instalar con la placa código W3091AA

Accesorios	Ref.	€/Ud.	Stock	Cant.
Kit aislamiento acústico inodoro/bidé suspendido	T604900	15		12

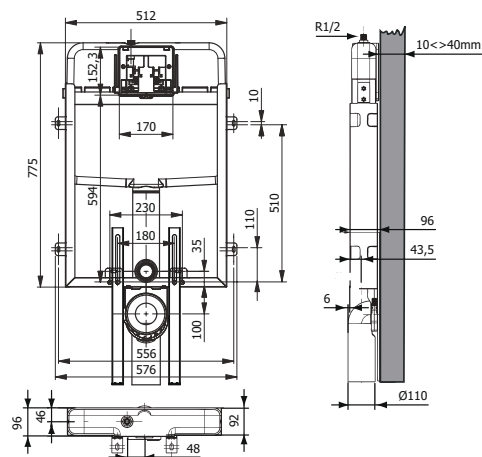

SISTEMA INSTALACIÓN MECÁNICO INODOROS



Acabado: Neutro	Ref.	€/Ud.	Stock	Cant.
Cisterna empotrada	W370067	95		12

Descripción

- Descarga Dual 3/6 Litros

Incluidos

- Cubierta anticondensación
- Válvula cierre G 1/2
- Conexión de entrada y salida del inodoro
- Codo de desagüe incluido

* Se tiene que instalar con la placa código W3091AA

Accesorios	Ref.	€/Ud.	Stock	Cant.
Kit aislamiento acústico inodoro/bidé suspendido	T604900	15		12

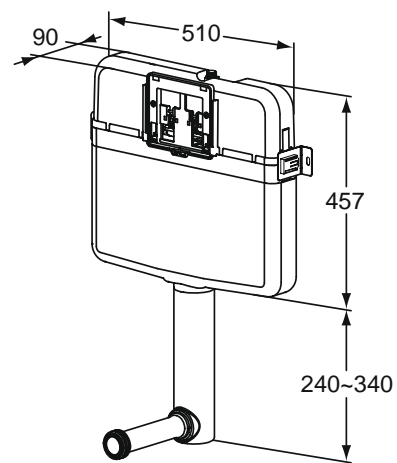

PLACA PULSADORA



Acabado	Ref.	€/Ud.	Stock	Cant.
 Cromo brillo	W3091AA	30		12

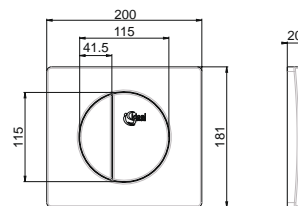



*Las patas son accesorios.
No vienen suministradas

SISTEMA INSTALACIÓN BIDÉS SUSPENDIDOS

Acabado: Neutro	Ref.	€/Ud.	Stock	Cant.
Sistema instalación bidés suspendido	VV610010	115		12

Descripción

- Estructura para bidé suspendido
- Empotrada en la pared
- Estructura galvanizada
- Espesor de 80 mm
- Placa de fijación ajustable

Incluidos

- Material de fijación del bidé
- Material de fijación de la estructura
- Code de desagüe

Necesario para la instalación	Ref.	€/Ud.	Stock	Cant.
Escuadras de fijación sistema bidé suspendido	VV622405	15		12
Accesorios	Ref.	€/Ud.	Stock	Cant.
Kit aislamiento acústico inodoro/bidé suspendido	T604900	15		12
Set de patas ajustables	VV620001	45		12

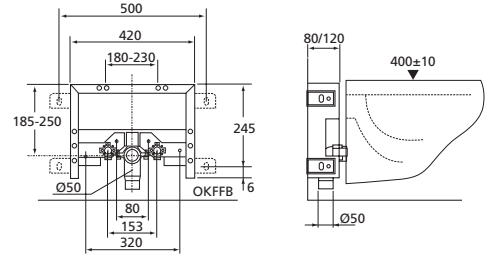

CERÁMICA

LAVABOS

Equipa tu baño.

El diseño que necesitas en tu espacio de baño.

TRADICIONAL 238

APOYO / SOBRE ENCIMERA 256

LAVABOS PARA MUEBLES 270

ENCASTRE 280



LAVABOS

INFORMACIÓN TÉCNICA

LAVABOS



CERÁMICA

LAVABOS

LAVABOS

LAVABOS

IPALYSS

STRADA II

STRADA

CONNECT AIR

LAVABOS
TRADICIONALES



215 €/Ud.
Pág. 246

185 €/Ud.
Pág. 248

95 €/Ud.
Pág. 248

LAVABOS
SOBRE ENCIMERA



465 €/Ud.
Pág. 264

225 €/Ud.
Pág. 266

175 €/Ud.
Pág. 268

LAVABOS
PARA MUEBLES



155 €/Ud.
Pág. 276

LAVABOS
ENCASTRE



225 €/Ud.
Pág. 284

LAVAMANOS



205 €/Ud.
Pág. 247



100 €/Ud.
Pág. 249

LAVABOS
ESPECIALES

CONNECT



80 €/Ud.
Pág. 250

TESI



50 €/Ud.
Pág. 252

TEMPO



50 €/Ud.
Pág. 253

EUROVIT PLUS



35 €/Ud.
Pág. 254

EUROVIT



125 €/Ud.
Pág. 277



115 €/Ud.
Pág. 278



175 €/Ud.
Pág. 284



80 €/Ud.
Pág. 250



35 €/Ud.
Pág. 254



70 €/Ud.
Pág. 255

CERÁMICA

LAVABOS TRADICIONALES

Solución ideal para espacios contemporáneos y vanguardistas que buscan optimizar el espacio sin renunciar al diseño.

LAVABOS

STRADA II



STRADA



LAVABOS

Grifería no comercializada por Ideal Standard Iberia

CONNECT AIR

Diseño elegante y versátil para vestir tu baño con formas rectas y clásicas, sin olvidar el estilo.

LAVABOS



CONNECT

Diseño minimalista para los que quieren aprovechar al máximo el espacio.



Grifería no comercializada por Ideal Standard Iberia

LAVABOS



Grifería no comercializada por Ideal Standard Iberia

EUROVIT PLUS

LAVABOS



Grifería y accesorios no comercializados por Ideal Standard Iberia

EUROVIT

Formas arriesgadas y combinación armónica de formas para hacer tu baño más divertido.





INFORMACIÓN TÉCNICA

LAVABOS TRADICIONALES

La versatilidad en cuanto a tamaños y estilos de la colección la presenta como una solución ideal para cualquier espacio

LAVABOS

LAVABOS TRADICIONALES



LAVABO
STRADA II



LAVABO
STRADA



LAVABO
CONNECT AIR



LAVABO
CONNECT



LAVABO
TEMPO



LAVABO
EUROVIT PLUS



LAVABO
EUROVIT

LAVABOS TRADICIONALES NOVEDAD

STRADA II

LAVABOS

LAVABO MURAL



Descripción

- Gres
- Instalación a pared o sobre encimera
- Juego de fijación a pared **no incluido Ref: J117767**
- Juego de fijación sobre encimera **no incluido Ref: D570967**
- Embellecedor desagüe blanco cerámico

Acabado: Blanco Brillo	Ref.	€/Ud.	Stock	Cant.
Lavabo mural 100 cm	T300201	465		10
Lavabo mural 80 cm	T300101	380		10
Lavabo mural 60 cm	T300001	245		10
Lavabo mural 50 cm	T292801	215		10

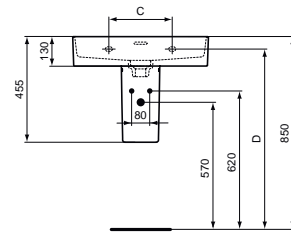

Opcional	Ref.	€/Ud.	Stock	Cant.
Semipedestal	T299601	100		10
Sifón de diseño	R6625AA	70		10
Juego fijación pared	J117767	5		10

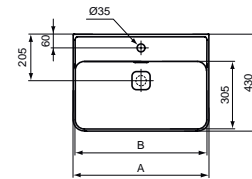

	A	B	C	D
T300201	1000	980	280	795
T300101	800	780	280	795
T300001	600	580	280	795
T292801	500	480	200	800

LAVABO MURAL



Descripción

- Gres
- Instalación a pared o sobre encimera
- Juego de fijación a pared **no incluido Ref: J117767**
- Juego de fijación sobre encimera **no incluido Ref: D570967**
- Embellecedor desagüe blanco cerámico

Acabado: Blanco Brillo	Ref.	€/Ud.	Stock	Cant.
Lavabo mural 120 cm 2 grifos	T359501	600		10
Lavabo mural 120 cm 1 grifo	T300601	600		10

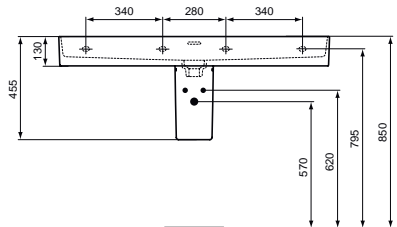

T359501

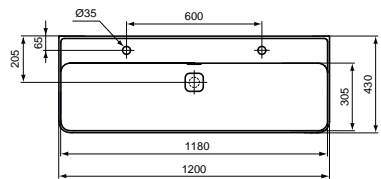

T300601

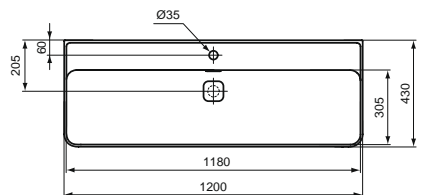



LAVAMANOS

Acabado: Blanco Brillo	Ref.	€/Ud.	Stock	Cant.
Lavamanos 45 cm Dch	T299401	205		10
Lavamanos 45 cm Izq	T299501	205		10
Opcional	Ref.	€/Ud.	Stock	Cant.
Sifón de diseño	R6625AA	70		10
Juego fijación pared	J117767	5		10

Descripción

- Gres
- Instalación a pared o sobre encimera
- Juego de fijación a pared **no incluido Ref: J117767**
- Juego de fijación sobre encimera **no incluido Ref: D570967**
- Embellecedor desagüe blanco cerámico

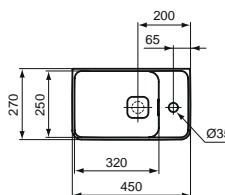
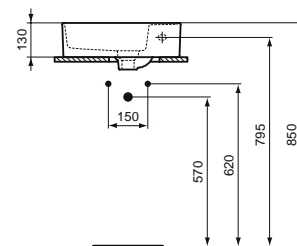

LAVABO SEMI-ENCASTRADO

Acabado: Blanco Brillo	Ref.	€/Ud.	Stock	Cant.
Lavabo semi-encastado 50x40	T299301	225		10



Descripción

- Gres
- Instalación semi-encastado
- Fijación semi-encastre **incluida**
- Embellecedor desagüe blanco cerámico

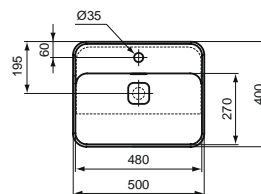
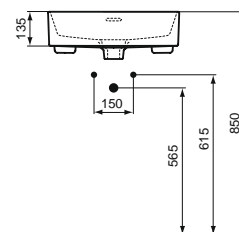

ACCESORIOS STRADA II



Acabado: Blanco Brillo	Ref.	€/Ud.	Stock	Cant.
Sempedestal	T299601	100		10

Fijación oculta incluida

* Este modelo no sirve para las Referencias:

T292801 · T300001 · T300101 · T300201 · T300601 · T359501



Acabado: Blanco Brillo	Ref.	€/Ud.	Stock	Cant.
Sifón de diseño	R6625AA	70		10



Acabado: Blanco Brillo	Ref.	€/Ud.	Stock	Cant.
Kit de fijación a pared	J117767	5		10

LAVABOS TRADICIONALES

STRADA

LAVABOS

LAVABO MURAL



Descripción

- Gres
 - Rebosadero visto
 - Con agujero central para grifo
 - Se recomienda instalación a pared.
- Instalación sobre encimera posible aunque parte posterior no esmaltada.
- Juego de fijación a pared

no incluido Ref: J117767

Acabado: Blanco Brillo	Ref.	€/Ud.	Stock	Cant.
Lavabo mural 90 cm	K078601	325		10
Lavabo mural 70 cm	K078201	240		10
Lavabo mural 60 cm	K077801	215		10
Lavabo mural 50 cm	K077701	185		10

Opcional	Ref.	€/Ud.	Stock	Cant.
Juego fijación pared	J117767	5		10
Sifón de diseño	R6625AA	70		10

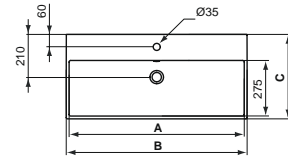
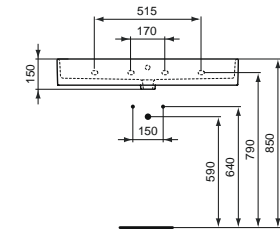

	A	B	A
K0786	870	910	420
K0782	670	710	420
K0778	570	600	420
K0777	470	500	420

ACCESORIOS STRADA



Acabado: Blanco Brillo	Ref.	€/Ud.	Stock	Cant.
Sifón de diseño	R6625AA	70		10



Acabado: Blanco Brillo	Ref.	€/Ud.	Stock	Cant.
Kit de fijación a pared	J117767	5		10

CONNECT AIR

LAVABO MURAL



Descripción

- Gres
- Con agujero central para grifo
- Rebosadero visto
- Juego de fijación a pared

no incluido Ref: J117767

Acabado: Blanco Brillo	Ref.	€/Ud.	Stock	Cant.
Lavabo mural 65 cm	E074101	125		10
Lavabo mural 60 cm	E074201	110		10
Lavabo mural 55 cm	E074401	100		10
Lavabo mural 50 cm	E074601	95		10

Opcional	Ref.	€/Ud.	Stock	Cant.
Juego fijación pared	J117767	5		10
Semipedestal Connect Air	E074801	70		10
Sifón de diseño	R6625AA	70		10

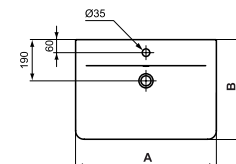
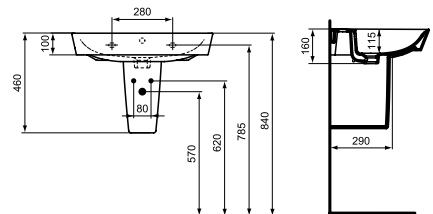

	A	B
E074101	650	460
E074201	600	460
E074401	550	460
E074601	480	450

CONNECT AIR



Descripción

- Gres
 - Con agujero central para grifo
 - Rebosadero visto
 - Juego de fijación a pared
- no incluido Ref: J117767**

LAVAMANOS

Acabado: Blanco Brillo	Ref.	€/Ud.	Stock	Cant.
Lavamanos 40 cm	E074701	100		10
Opcional	Ref.	€/Ud.	Stock	Cant.
Juego fijación pared	J117767	5		10
Semipedestal Connect Air	E074801	70		10
Sifón de diseño	R6625AA	70		10

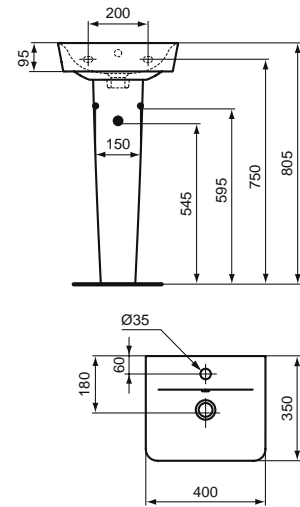

ACCESORIOS CONNECT AIR



Acabado: Blanco Brillo	Ref.	€/Ud.	Stock	Cant.
Semipedestal	E074801	70		10



Acabado: Blanco Brillo	Ref.	€/Ud.	Stock	Cant.
Sifón de diseño	R6625AA	70		10



Acabado: Blanco Brillo	Ref.	€/Ud.	Stock	Cant.
Kit de fijación a pared	J117767	5		10

LAVABOS TRADICIONALES

CONNECT



Descripción

- Gres
 - **En caja**
 - Con agujero central para grifo
 - Rebosadero visto
 - Juego de fijación a pared
- no incluido Ref: J117767**

LAVABO MURAL CÚBICO (EN CAJA)

NOVEDAD

Acabado: Blanco Brillo	Ref.	€/Ud.	Stock	Cant.
Lavabo mural rectangular 60 cm sin fijación	E794501	85		10
Opcional	Ref.	€/Ud.	Stock	Cant.
Juego fijación pared	J117767	5		10
Semipedestal	E074801	66		10
Sifón de diseño	R6625AA	70		10

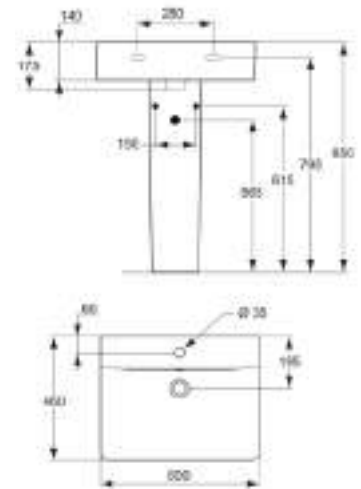

LAVABOS



Descripción

- Gres
 - **Sin caja**
 - Con agujero central para grifo
 - Rebosadero visto
 - Juego de fijación a pared
- no incluido Ref: J117767**

LAVABO MURAL CÚBICO (SIN CAJA)

Acabado: Blanco Brillo	Ref.	€/Ud.	Stock	Cant.
Lavabo mural rectangular 65 cm sin fijación	E772901	100		10
Lavabo mural rectangular 55 cm sin fijación	E713901	80		10
Lavabo mural rectangular 50 cm sin fijación	E713801	82		10
Opcional	Ref.	€/Ud.	Stock	Cant.
Juego fijación pared	J117767	5		10
Semipedestal	E074801	66		10
Sifón de diseño	R6625AA	70		10

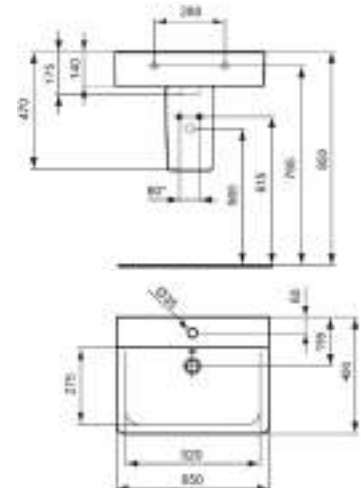

Descripción

- Gres
 - **Sin caja**
 - Con agujero central para grifo
 - Rebosadero visto
 - Juego de fijación a pared
- no incluido Ref: J117767**

LAVAMANOS CÚBICO

Acabado: Blanco Brillo	Ref.	€/Ud.	Stock	Cant.
Lavabo mural rectangular 55 cm corta proyección con fijación	E714001	80		10
Opcional	Ref.	€/Ud.	Stock	Cant.
Juego fijación pared	J117767	5		10
Semipedestal	E074801	66		10
Sifón de diseño	R6625AA	70		10

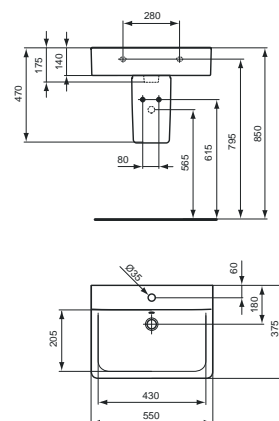



LAVAMANOS CÚBICO

Acabado: Blanco Brillo	Ref.	€/Ud.	Stock	Cant.
Lavamanos cúbico 40 cm	E713701	80		10

Descripción

- Gres
- **Sin caja**
- Con agujero central para grifo
- Rebosadero visto
- Juego de fijación a pared
no incluido Ref. J117767

Opcional	Ref.	€/Ud.	Stock	Cant.
Juego fijación pared	J117767	5		10
Semipedestal	E074801	66		10
Sifón de diseño	R6625AA	70		10

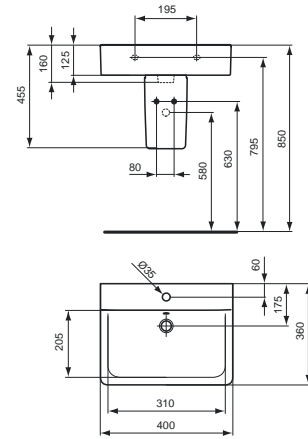

ACCESORIOS CONNECT



Acabado: Blanco Brillo	Ref.	€/Ud.	Stock	Cant.
Semipedestal (sin caja)	E074801	88		10



Acabado: Blanco Brillo	Ref.	€/Ud.	Stock	Cant.
Semipedestal (sin caja)	E711401	70		10



Acabado: Blanco Brillo	Ref.	€/Ud.	Stock	Cant.
Sifón de diseño	R6625AA	70		10



Acabado: Blanco Brillo	Ref.	€/Ud.	Stock	Cant.
Kit de fijación a pared	J117767	5		10

LAVABOS TRADICIONALES NOVEDAD

TEMPO

LAVABOS



Descripción

- Gres
- Con agujero central para grifo
- Rebosadero visto
- Juego de fijación no incluido en caja

LAVABO MURAL EN CAJA

Acabado: Blanco Brillo	Ref.	€/Ud.	Stock	Cant.
Lavabo mural 65 x 50 cm	T056301	90		6
Lavabo mural 60 x 50 cm	T056401	85		6
Lavabo mural 55 x 45 cm	T056501	80		6
Lavabo mural 50 x 44 cm	T056601	70		6
Opcional	Ref.	€/Ud.	Stock	Cant.
Tempo pedestal	T422901	45		6
Tempo semipedestal	T423001	45		6

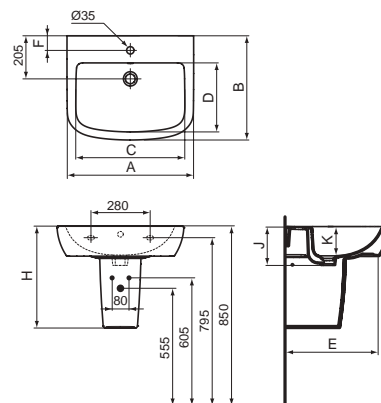

	A	B	C	D	E	F	G	H	J	K
T056301	650	525	560	355	480	65	145	485	185	140
T056401	600	495	520	330	450	70	145	480	185	140
T056501	550	450	475	290	320	70	140	485	185	135
T056601	500	440	430	285	400	60	150	480	190	135



Descripción

- Gres
- Con agujero central para grifo
- Rebosadero visto
- Juego de fijación no incluido en caja

LAVABO MURAL EN CAJA

Acabado: Blanco Brillo	Ref.	€/Ud.	Stock	Cant.
Lavabo mural 40 x 36 cm	T056701	55		6
Opcional	Ref.	€/Ud.	Stock	Cant.
Tempo pedestal	T422901	45		6
Tempo semipedestal	T423001	45		6

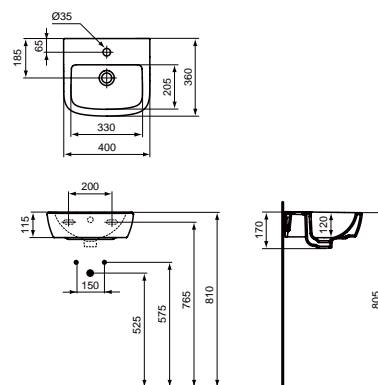

ACCESORIOS TEMPO



Acabado: Blanco Brillo	Ref.	€/Ud.	Stock	Cant.
Tempo pedestal	T422901	45		6

Acabado: Blanco Brillo	Ref.	€/Ud.	Stock	Cant.
Tempo semipedestal	T423001	45		6

EUROVIT PLUS



LAVABO MURAL CÚBICO

Acabado: Blanco Brillo	Ref.	€/Ud.	Stock	Cant.
Lavabo cúbico 65 cm	V302801	56		10
Lavabo cúbico 60 cm	V302701	50		10

Descripción

- Gres
 - **Sin caja**
 - Con agujero central para grifo
 - Rebosadero visto
 - Juego de fijación a pared
- no incluido Ref: J117767**

Opcional	Ref.	€/Ud.	Stock	Cant.
Juego fijación pared	J117767	5		10
Pedestal	R206601	50		10
Semipedestal	R330901	45		10

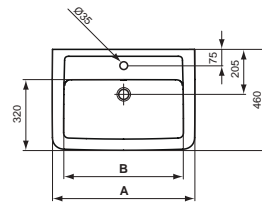
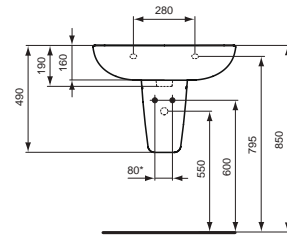

	A	B
V302801	650	545
V302701	600	495

ACCESORIOS EUROVIT PLUS



Acabado: Blanco Brillo	Ref.	€/Ud.	Stock	Cant.
Pedestal	R206601	50		10



Acabado: Blanco Brillo	Ref.	€/Ud.	Stock	Cant.
Semipedestal	R330901	45		10



Acabado: Blanco Brillo	Ref.	€/Ud.	Stock	Cant.
Sifón de diseño	R6625AA	70		10



Acabado: Blanco Brillo	Ref.	€/Ud.	Stock	Cant.
Kit de fijación a pared	J117767	5		10

LAVABOS TRADICIONALES

EUROVIT



LAVABOS

Acabado: Blanco Brillo	Ref.	€/Ud.	Stock	Cant.
Lavabo 65 cm	W444001	45		10
Lavabo 60 cm	W424001	40		10
Lavabo 55 cm	W434001	38		10
Lavabo 50 cm* **	V200101	35		10

*No se puede instalar con pedestal/semipedestal

**Sin caja

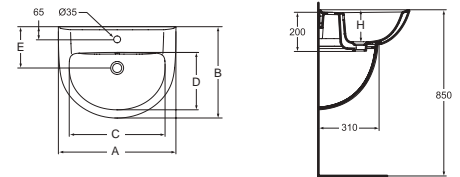
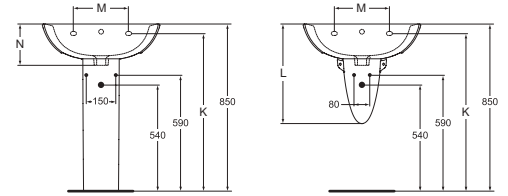

Descripción

- Gres
 - Con agujero central para grifo
 - Rebosadero visto
 - Juego de fijación a pared
- no incluido Ref: J117767**

Opcional	Ref.	€/Ud.	Stock	Cant.
Juego fijación pared	J117767	5		10
Pedestal sin caja	V914001	30		10
Semipedestal sin caja	V921001	28		10

	A	B	C	D	E	H	K	L	M	N
W444001	650	480	530	305	210	165	800	510	280	210
W424001	600	456	500	290	215	165	800	510	280	210
W434001	550	450	450	275	200	170	790	515	285	220
V200101	500	350	418	250	170	165	795	--	200	195

LAVABOS



LAVAMANOS

Acabado: Blanco Brillo	Ref.	€/Ud.	Stock	Cant.
Lavamanos 35 dch*	W407901	35		10
Lavamanos 35 izq*	W407501	35		10

*No se puede instalar con pedestal

Opcional	Ref.	€/Ud.	Stock	Cant.
Semipedestal corto	E711401	70		10
Juego de Fijación	J117767	5		10

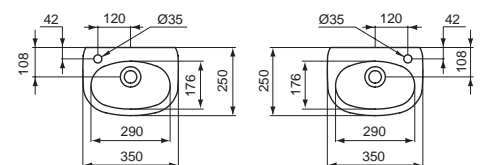
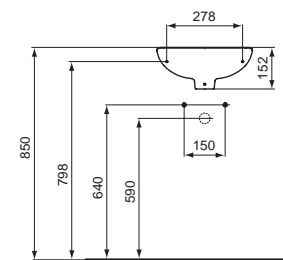

Descripción

- Cerámica
 - Con agujero para grifo
 - Rebosadero visto
 - Juego de fijación a pared
- no incluido Ref: J117767**

EUROVIT



LAVABO ESQUINA

Acabado: Blanco Brillo	Ref.	€/Ud.	Stock	Cant.
Lavabo esquina 48 cm	W420201	70		10
Opcional	Ref.	€/Ud.	Stock	Cant.
Juego de Fijación	J117767	5		10

Descripción

- Cerámica
 - Con agujero central para grifo
 - Rebosadero visto
 - Juego de fijación a pared
- no incluido Ref: J117767**

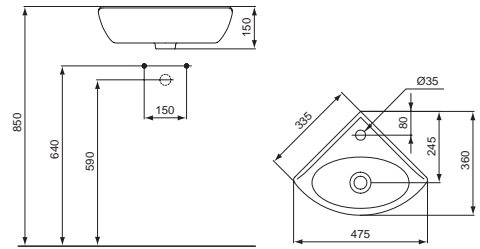

ACCESORIOS EUROVIT



Acabado: Blanco Brillo	Ref.	€/Ud.	Stock	Cant.
Pedestal (sin caja)	V914001	30		10



Acabado: Blanco Brillo	Ref.	€/Ud.	Stock	Cant.
Semipedestal (sin caja)	V921001	28		10



Acabado: Blanco Brillo	Ref.	€/Ud.	Stock	Cant.
Semipedestal corto (sin caja)	E711401	70		10



Acabado: Blanco Brillo	Ref.	€/Ud.	Stock	Cant.
Kit de fijación a pared	J117767	5		10

CERÁMICA

LAVABOS SOBRE ENCIMERA

Belleza y estilo al servicio de los sentidos.
Sus diversas líneas de diseño aportarán vida
a cuartos de baño de todos los estilos.

LAVABOS

IPALYSS



BELLEZA CON
FUERZA INTERIOR



LAVABOS



Diamatec
technology

EL DISEÑO MÁS LIGERO DE TODOS

LAVABOS DIAMATEC CON
ESPESOR DE 3,5 MM

STRADA II

LAVABOS





LAVABOS



CONNECT AIR

LAVABOS





LAVABOS





INFORMACIÓN TÉCNICA

LAVABOS SOBRE ENCIMERA

Imprime elegancia y modernidad al espacio a través de las múltiples variedades de diseño que ofrece.

LAVABOS

LAVABOS SOBRE ENCIMERA



LAVABOS
IPALYSS



LAVABOS REDONDOS | OVALADOS
STRADA II



LAVABOS CUADRADOS | RECTANGULARES
STRADA II



LAVABO
CONNECT AIR

LAVABOS SOBRE ENCIMERA

IPALYSS



Descripción

- Lavabo 55x40 cm
- 3,8 mm de radio
- Sin orificio para grifo
- Sin rebosadero
- **Tecnología Diamatec**

LAVABO ENCIMERA 55 CM

Acabado: Blanco Brillo	Ref.	€/Ud.	Stock	Cant.
Lavabo Encimera Ipalys 55 cm sin rebosadero	E139201	465		10
Opcional	Ref.	€/Ud.	Stock	Cant.
Sifón de diseño	R6625AA	70		10

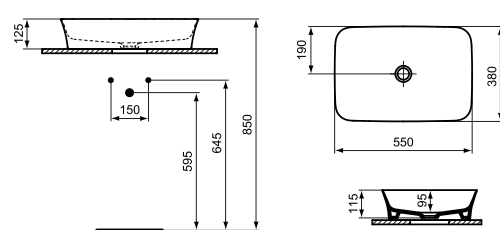

Descripción

- Lavabo 55x40 cm
- 3,8 mm de radio
- Sin orificio para grifo
- Con rebosadero visto
- **Tecnología Diamatec**

LAVABO ENCIMERA 55 CM

Acabado: Blanco Brillo	Ref.	€/Ud.	Stock	Cant.
Lavabo Encimera Ipalys 55 cm con rebosadero	E139401	465		10
Opcional	Ref.	€/Ud.	Stock	Cant.
Sifón de diseño	R6625AA	70		10

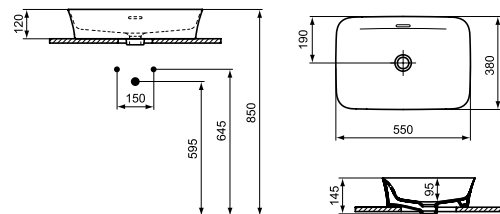

Descripción

- Lavabo 55x40 cm
- 3,8 mm de radio
- Con orificio para grifo
- **Tecnología Diamatec**

LAVABO ENCIMERA 55 CM

Acabado: Blanco Brillo	Ref.	€/Ud.	Stock	Cant.
Lavabo Encimera Ipalys 55 cm con rebosadero con orificio grifo	E139301	465		10
Opcional	Ref.	€/Ud.	Stock	Cant.
Sifón de diseño	R6625AA	70		10
Kit de fijacion sobre encimera	D570967	25		10

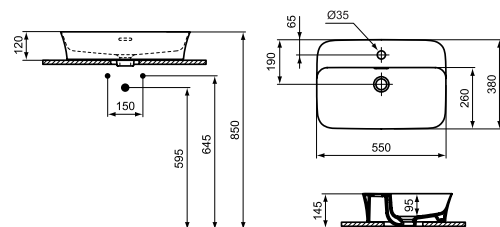

ACCESORIOS IPALYSS



Acabado: Blanco Brillo	Ref.	€/Ud.	Stock	Cant.
Sifón de diseño	R6625AA	70		10



LAVABOS SOBRE ENCIMERA

NOVEDAD

STRADA II



LAVABO ENCIMERA RECTANGULAR

Acabado: Blanco Brillo	Ref.	€/Ud.	Stock	Cant.
Lavabo Encimera rectangular 50x40 cm con rebosadero	T296501	275		
Lavabo Encimera rectangular 50x40 cm sin rebosadero	T296701	275		10
Lavabo Encimera rectangular 60x40 cm sin rebosadero	T299901	325		10
Opcional	Ref.	€/Ud.	Stock	Cant.
Sifón de diseño	R6625AA	70		10

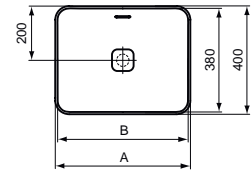
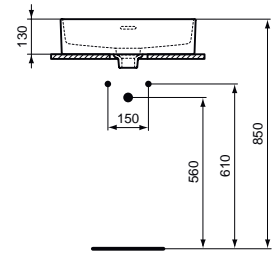

	A	B
T296501	500	480
T296701	500	480
T299901	600	580

Descripción

- Gres
- Instalación sobre encimera
- Sin orificio para grifo
- **Kit fijación incluido**
- Embellecedor desagüe blanco cerámico

LAVABOS



LAVABO ENCIMERA RECTANGULAR

Acabado: Blanco Brillo	Ref.	€/Ud.	Stock	Cant.
Lavabo Encimera rectangular 50x40 cm con rebosadero	T296601	275		10
Lavabo Encimera rectangular 60x40 cm con rebosadero	T299801	325		10
Opcional	Ref.	€/Ud.	Stock	Cant.
Sifón de diseño	R6625AA	70		10

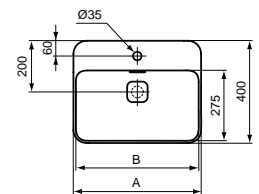
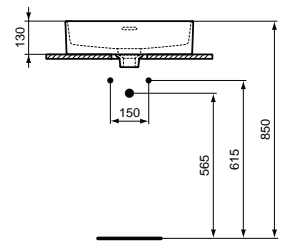

	A	B
T296601	500	485
T299801	600	585

Descripción

- Gres
- Instalación sobre encimera
- Con orificio para grifo
- **Kit fijación incluido**
- Embellecedor desagüe blanco cerámico



LAVABO ENCIMERA CUADRADO 40 CM

Acabado: Blanco Brillo	Ref.	€/Ud.	Stock	Cant.
Lavabo Encimera redondo 40 cm sin rebosadero	T296201	225		10
Lavabo Encimera redondo 40 cm con rebosadero	T296301	225		10
Opcional	Ref.	€/Ud.	Stock	Cant.
Sifón de diseño	R6625AA	70		10

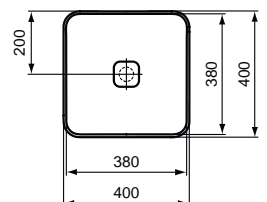
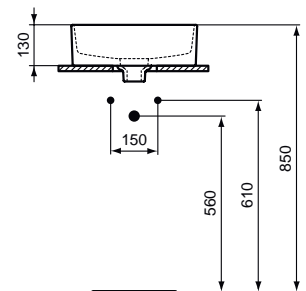

Descripción

- Gres
- Instalación sobre encimera
- Sin orificio para grifo
- **Kit fijación incluido**
- Embellecedor desagüe blanco cerámico



LAVABO ENCIMERA REDONDO

Acabado: Blanco Brillo	Ref.	€/Ud.	Stock	Cant.
Lavabo Encimera redondo 38x38 cm con rebosadero	T292901	225		10
Opcional	Ref.	€/Ud.	Stock	Cant.
Sifón de diseño	R6625AA	70		10

Descripción

- Gres
- Instalación sobre encimera
- Sin orificio para grifo
- **Kit fijación incluido**
- Embellecedor desagüe blanco cerámico

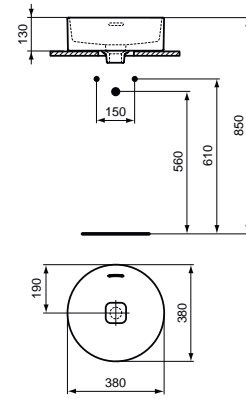

LAVABO ENCIMERA REDONDO

Acabado: Blanco Brillo	Ref.	€/Ud.	Stock	Cant.
Lavabo Encimera redondo 45x45 cm sin rebosadero	T295901	250		10
Lavabo Encimera redondo 45x45 cm con rebosadero	T296101	250		10
Opcional	Ref.	€/Ud.	Stock	Cant.
Sifón de diseño	R6625AA	70		10

Descripción

- Gres
- Instalación sobre encimera
- Sin orificio para grifo
- **Kit fijación incluido**
- Embellecedor desagüe blanco cerámico

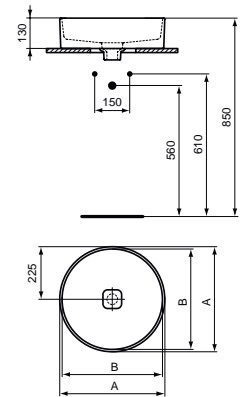

	A	B
T295901	450	430
T296101	450	430



LAVABO ENCIMERA OVALADO 60 CM

Acabado: Blanco Brillo	Ref.	€/Ud.	Stock	Cant.
Lavabo Encimera ovalado 60 cm sin rebosadero	T298101	325		10
Lavabo Encimera ovalado 60 cm con rebosadero	T360401	325		10
Lavabo Encimera ovalado 75 cm sin rebosadero	T298001	375		10
Opcional	Ref.	€/Ud.	Stock	Cant.
Sifón de diseño	R6625AA	70		10

Descripción

- Gres
- Instalación sobre encimera
- Sin orificio para grifo
- **Kit fijación incluido**
- Embellecedor desagüe blanco cerámico

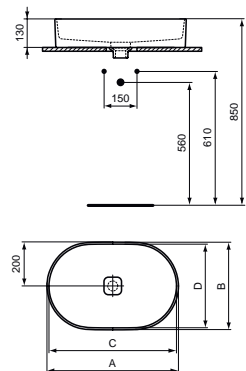

	A	B	C	D
T298101	600	400	580	380
T360401	600	400	580	380
T298001	750	400	730	380

ACCESORIOS STRADA II



Acabado: Blanco Brillo	Ref.	€/Ud.	Stock	Cant.
Sifón de diseño	R6625AA	70		10

LAVABOS SOBRE ENCIMERA

CONNECT AIR

LAVABOS



LAVABO DE APOYO 60X40 CM

Acabado: Blanco Brillo	Ref.	€/Ud.	Stock	Cant.
Lavabo de apoyo 60 cm	E034801	225		10

Descripción

- Lavabo de 60x40 cm
- Sin orificio para grifo
- Sin rebosadero
- **Kit fijación incluido**

Opcional	Ref.	€/Ud.	Stock	Cant.
Sifón de diseño	R6625AA	70		10

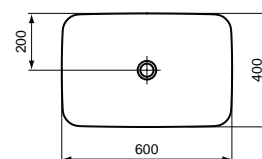
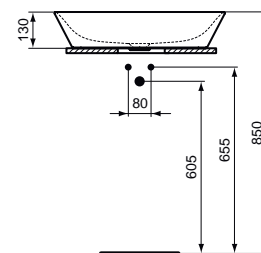

LAVABO DE APOYO 40X40 CM

Acabado: Blanco Brillo	Ref.	€/Ud.	Stock	Cant.
Lavabo de apoyo 40 cm	E034701	175		10

Descripción

- Lavabo de 40x40 cm
- Sin orificio para grifo
- Sin rebosadero
- **Kit fijación incluido**

Opcional	Ref.	€/Ud.	Stock	Cant.
Sifón de diseño	R6625AA	70		10

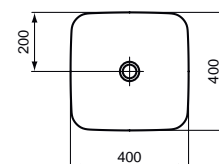
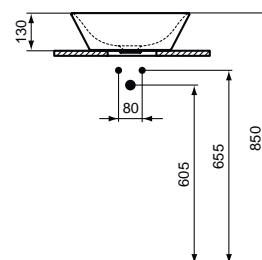

ACCESORIOS CONNECT AIR



Acabado: Blanco Brillo	Ref.	€/Ud.	Stock	Cant.
Sifón de diseño	R6625AA	70		10



Mobiliario no comercializado por Ideal Standard Iberia

CERÁMICA

LAVABOS PARA MUEBLE

La integración total con el mueble permitirá ganar en funcionalidad al mismo tiempo que aporta armonía y equilibrio al espacio.

LAVABOS

CONNECT AIR





TESI

LAVABOS





LAVABOS

TEMPO





INFORMACIÓN TÉCNICA

LAVABOS PARA MUEBLE

Los bordes finos y las líneas suaves del diseño crean un ambiente armonioso y ligero.

LAVABOS

LAVABOS PARA MUEBLE



LAVABOS TOP
CONNECT AIR



LAVABOS TOP
TESI



LAVABOS TOP
TEMPO

LAVABOS PARA MUEBLE NOVEDAD

CONNECT AIR

LAVABOS

LAVABOS TOP



Acabado: Blanco Brillo	Ref.	€/Ud.	Stock	Cant.
Lavabo Top 100 cm	E027401	200		10
Lavabo Top 80 cm*	E027901	285		10
Lavabo Top 60 cm*	E028901	205		10
Lavabo Top 50 cm	E029601	155		10

*Compatible con los muebles Tempo de 60 y 80 cm.

Opcional	Ref.	€/Ud.	Stock	Cant.
Juego fijación pared	J117767	5		10
Semipedestal	E074801	70		10
Sifón de diseño	R6625AA	70		10

Descripción

- Gres
- Con agujero central para grifo
- Con rebosadero
- Los lavabos de medidas 50, 60, 80 y 100 cm se pueden fijar a pared con el **juego de fijación opcional no incluido**
- Las medidas de 60 y 80 cm son compatibles con los muebles Tempo

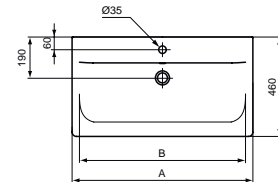
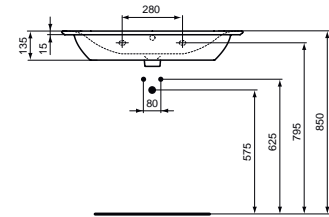

	A	B
E027401	1040	940
E027901	840	740
E028901	640	540
E029601	540	540

LAVABO TOP DOBLE



Acabado: Blanco Brillo	Ref.	€/Ud.	Stock	Cant.
Lavabo Top 120 cm	E027301	300		10

Opcional	Ref.	€/Ud.	Stock	Cant.
Juego fijación pared	J117767	5		10
Semipedestal	E074801	70		10
Sifón de diseño	R6625AA	70		10

Descripción

- Gres
- Con 2 agujeros para grifo
- Con rebosadero
- El lavabo de medida 120 cm se pueden fijar a pared con el **juego de fijación opcional no incluido**

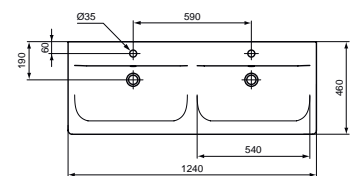
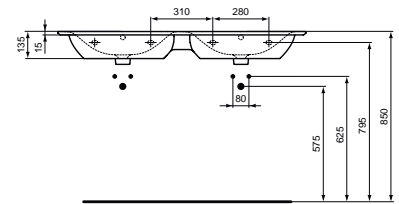

ACCESORIOS CONNECT AIR



Acabado: Blanco Brillo	Ref.	€/Ud.	Stock	Cant.
Semipedestal	E074801	70		10



Acabado: Blanco Brillo	Ref.	€/Ud.	Stock	Cant.
Sifón de diseño	R6625AA	70		10



Acabado: Blanco Brillo	Ref.	€/Ud.	Stock	Cant.
Kit de fijación a pared	J117767	5		10

TESI

LAVABOS TOP



Acabado: Blanco Brillo	Ref.	€/Ud.	Stock	Cant.
Lavabo top 100	T350801	175		10
Lavabo top 80*	T350901	150		10
Lavabo top 60*	T351001	125		10

*Compatible con los muebles Tempo de 60 y 80 cm.

Descripción

- Gres
- Con agujero central para grifo
- Para instalación con pedestal, semipedestal y sifón de diseño
- Los lavabos de medidas 50, 60, 80 y 100 cm se pueden fijar a pared con el **juego de fijación opcional no incluido**
- Las medidas de 60 y 80 cm son compatibles con los muebles Tempo

Opcional	Ref.	€/Ud.	Stock	Cant.
Juego fijación pared	J117767	5		10
Pedestal	T351901	50		10
Semipedestal	T351801	50		10

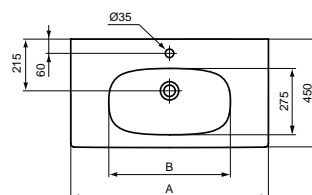
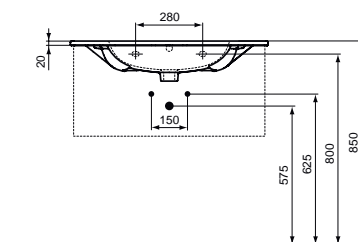

	A	B
T350801	1025	600
T350901	825	505
T351001	625	460

MINI LAVABOS TOP



Acabado: Blanco Brillo	Ref.	€/Ud.	Stock	Cant.
Lavabo top 50	T351101	90		10

Descripción

- Gres
- Con agujero central para grifo
- Para instalación con pedestal, semipedestal y sifón de diseño

Opcional	Ref.	€/Ud.	Stock	Cant.
Juego fijación pared	J117767	5		10
Pedestal	T351901	50		10
Semipedestal	T351801	50		10

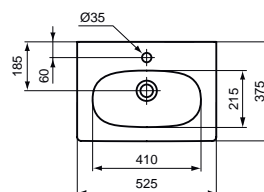
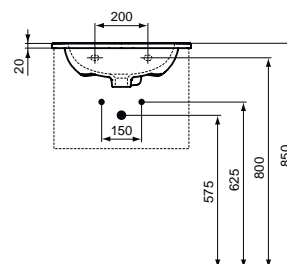

ACCESORIOS TESI



Acabado: Blanco Brillo	Ref.	€/Ud.	Stock	Cant.
Pedestal	T351901	50		10

Acabado: Blanco Brillo	Ref.	€/Ud.	Stock	Cant.
Semipedestal	T351801	50		10

LAVABOS PARA MUEBLE TEMPO

LAVABOS TOP



Acabado: Blanco Brillo	Ref.	€/Ud.	Stock	Cant.
Lavabo encimera 80 cm	E066901	125		10
Lavabo encimera 60 cm	E066801	115		10

*Compatible con los muebles Tempo de 60 y 80 cm.

Descripción

- Gres
- Con agujero central para grifo
- Solamente pueden instalarse en muebles porque no lleva fijación a pared

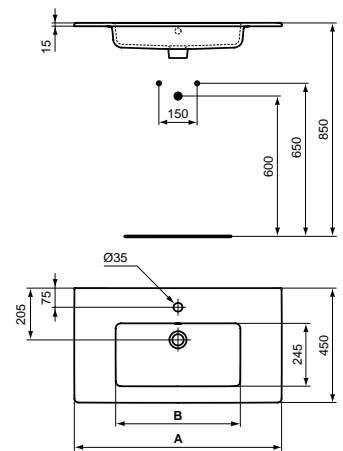

	A	B
E066901	815	490
E066801	610	400



CERÁMICA

LAVABOS ENCASTRE

Su fusión con el mueble de baño o encimera conforman la unidad perfecta para aprovechar al máximo el espacio.

LAVABOS

STRADA II



CONNECT



Grifería no comercializada por Ideal Standard Iberia



INFORMACIÓN TÉCNICA

LAVABOS
ENCASTRE

Su elegante diseño de líneas rectas y sencillas apuesta por la versatilidad y equilibrio de formas para integrarse perfectamente en cualquier baño.

LAVABOS ENCASTRE

LAVABO SEMIENCASTRE
STRADA IILAVABO ENCASTRE OVALADO
SIN ORIFICIO CONNECTLAVABO ENCASTRE OVALADO
CON ORIFICIO CONNECTLAVABO ENCASTRE REDONDO
SIN ORIFICIO CONNECTLAVABO ENCASTRE REDONDO
CON ORIFICIO CONNECTLAVABO BAJO PLANO
RECTANGULAR CONNECTLAVABO BAJO PLANO
OVALADO CONNECTLAVABO BAJO PLANO
REDONDO CONNECT

LAVABOS ENCASTRE STRADA II



Descripción

- Gres
- Instalación semi-encastado
- **Fijación semi-encastre incluida**
- Embellecedor desagüe blanco cerámico
- Rebosadero visto

LAVABO SEMI-ENCASTRADO NOVEDAD

Acabado: Blanco Brillo	Ref.	€/Ud.	Stock	Cant.
Lavabo semi-encastado 50x40	T299301	225		10

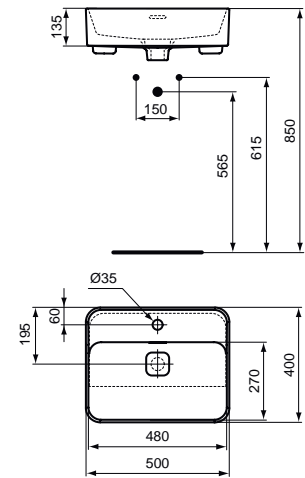

CONNECT



Descripción

- Gres
- Montado por debajo de la encimera
- Sin agujero central para grifo
- Rebosadero visto
- **Juego de fijación incluido**

LAVABO DE ENCASTRE RECTANGULAR

Acabado: Blanco Brillo	Ref.	€/Ud.	Stock	Cant.
Lavabo bajo plano rectangular 42cm	E505601	95		10
Lavabo bajo plano rectangular 50cm	E505801	105		10
Lavabo bajo plano rectangular 58cm	E506101	115		10

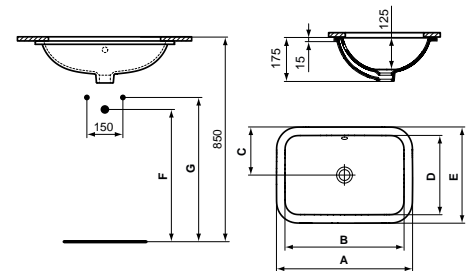

Opcional	Ref.	€/Ud.	Stock	Cant.
Sifón de diseño	R6625AA	70		10

	A	B	C	D	E	F	G
E5061	580	510	205	340	410	540	590
E5058	500	430	190	310	380	540	590
E5056	420	355	175	285	350	565	615

LAVABO DE ENCASTRE OVALADO



Descripción

- Gres
- Con agujero central para grifo
- Rebosadero visto
- **Juego de fijación incluido**

Acabado: Blanco Brillo	Ref.	€/Ud.	Stock	Cant.
Lavabo encastre ovalado 48cm	E503801	55		10
Lavabo encastre ovalado 55cm	E503901	75		10
Lavabo encastre ovalado 62cm	E504001	85		10

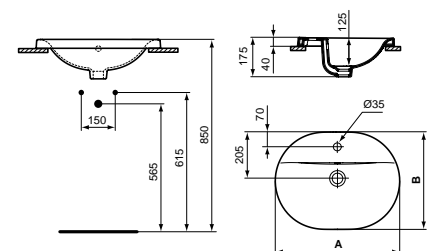

Opcional	Ref.	€/Ud.	Stock	Cant.
Sifón de diseño	R6625AA	70		10

	A	B
E5038	480	400
E5039	550	430
E5040	620	460

CONNECT

LAVABO DE ENCASTRE OVALADO



Acabado: Blanco Brillo	Ref.	€/Ud.	Stock	Cant.
Lavabo encastre sin orificio grifo 48cm	E504501	75		10
Lavabo encastre sin orificio grifo 55cm	E504701	85		10
Lavabo encastre sin orificio grifo 62cm	E504901	95		10

Descripción

- Gres
- Sin agujero central para grifo
- Rebosadero visto
- **Juego de fijación incluido**

Opcional	Ref.	€/Ud.	Stock	Cant.
Sifón de diseño	R6625AA	70		10

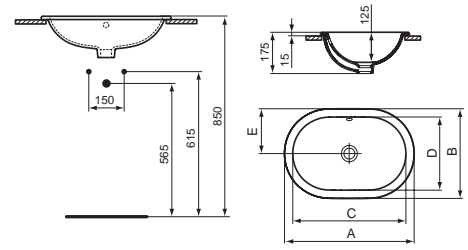

	A	B	C	D	E
E5045	480	350	415	285	175
E5047	550	380	480	310	190
E5049	620	410	545	335	205

LAVABO DE ENCASTRE OVALADO



Acabado: Blanco Brillo	Ref.	€/Ud.	Stock	Cant.
Lavabo bajo plano Connect 48cm	E504601	75		10
Lavabo bajo plano Connect 55cm	E504801	85		10
Lavabo bajo plano Connect 62cm	E505001	95		10

Descripción

- Gres
- Montado por debajo de la encimera
- Sin agujero central para grifo
- Rebosadero visto
- **Juego de fijación incluido**

Opcional	Ref.	€/Ud.	Stock	Cant.
Sifón de diseño	R6625AA	70		10

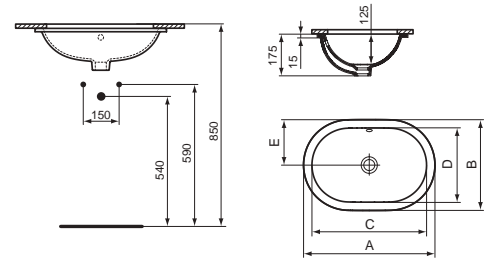

	A	B	C	D	E
E5046	480	350	415	285	175
E5048	550	380	480	310	190
E5050	620	410	545	335	205

LAVABO DE ENCASTRE REDONDO



Acabado: Blanco Brillo	Ref.	€/Ud.	Stock	Cant.
Lavabo encastre redondo sin orificio grifo 38cm	E505101	75		10
Lavabo encastre redondo sin orificio grifo 48cm	E505301	85		10

Descripción

- Gres
- Sin agujero central para grifo
- Rebosadero visto
- **Juego de fijación incluido**

Opcional	Ref.	€/Ud.	Stock	Cant.
Sifón de diseño	R6625AA	70		10

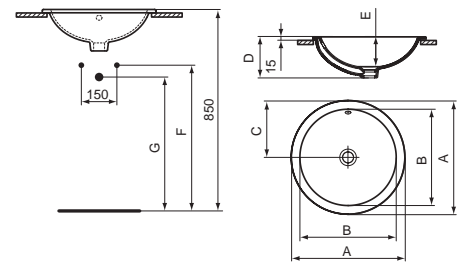

	A	B	C	D	E	F	G
E5051	380	310	190	165	120	625	575
E5053	480	405	240	175	130	615	565

LAVABOS ENCASTRE CONNECT



Descripción

- Gres
- Montado por debajo de la encimera
- Sin agujero central para grifo
- Rebosadero visto
- **Juego de fijación incluido**

LAVABO DE ENCASTRE REDONDO

Acabado: Blanco Brillo	Ref.	€/Ud.	Stock	Cant.
Lavabo bajo plano redondo 38cm	E505201	75		10
Lavabo bajo plano redondo 48cm	E505401	85		10

Opcional	Ref.	€/Ud.	Stock	Cant.
Sifón de diseño	R6625AA	70		10

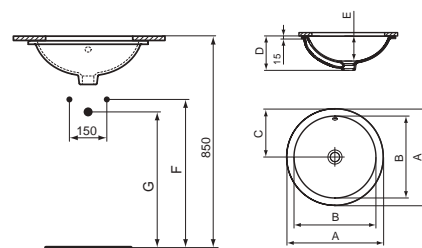

	A	B	C	D	E	F	G
E5054	480	405	240	175	130	590	540
E5052	380	310	190	165	120	600	550

LAVABOS



Descripción

- Gres
- Con agujero central para grifo
- Rebosadero visto
- **Juego de fijación incluido**

LAVABO DE ENCASTRE REDONDO

Acabado: Blanco Brillo	Ref.	€/Ud.	Stock	Cant.
Lavabo encastre redondo 38cm	E504101	75		10
Lavabo encastre redondo 48cm	E504201	80		10

Opcional	Ref.	€/Ud.	Stock	Cant.
Sifón de diseño	R6625AA	70		10

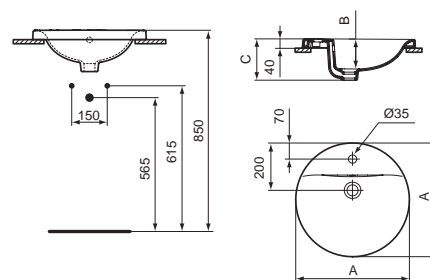

	A	B	C
E5041	380	115	165
E5042	480	125	175



IDEAL STANDARD

MUEBLES Y ESPEJOS

Sencillez, elegancia y modernidad para los que buscan un sentido estético a la funcionalidad.

MUEBLE MODULAR 298

MUEBLE DE PUERTAS Y CAJONES 312

ESPEJOS Y LUMINARIAS 320



MUEBLES

INFORMACIÓN TÉCNICA

MUEBLES Y ESPEJOS

LEYENDA DE ICONOS













































Cierre amortiguado











































MATRIZ DE COMPATIBILIDAD

LAVABOS DE APOYO

Serie	Encimera	IPALYSS			CONNECT AIR		STRADA II	
		E1392 50 x 38 cm	E1393 50 x 38 cm	E1394 50 x 38 cm	E0347 40 x 40 cm	E0348 60 x 40 cm	T2998 60 x 40 cm	T2999 60 x 40 cm
ADAPTO	U8405 600 x 122 x 505 mm							
	U8406 700 x 122 x 505 mm							
	U8407 850 x 122 x 505 mm							
	U8408 1050 x 122 x 505 mm							
	U8409 1200 x 122 x 505 mm							
	U8593 1500 x 122 x 505 mm							

LAVABOS DE ENCASTRE

Serie	Encimera	CONNECT						
		E5038 48 cm	E5039 55 cm	E5040 62 cm	E5041 38 cm	E5042 48 cm	E5045 48 cm	E5047 55 cm
ADAPTO	U8405 600 x 122 x 505 mm							
	U8406 700 x 122 x 505 mm							
	U8407 850 x 122 x 505 mm							
	U8408 1050 x 122 x 505 mm							
	U8409 1200 x 122 x 505 mm							
	U8593 1500 x 122 x 505 mm							

LAVABOS DE APOYO

STRADA II										
T2965 50 x 40 cm	T2966 50 x 40 cm	T2967 50 x 40 cm	T2980 Ø 75 cm	T2981 Ø 60 cm	T3604 Ø 60 cm	T2929 38 x 38 cm	T2959 45 x 45 cm	T2961 45 x 45 cm	T2962 40 cm	T2963 40 cm

LAVABOS DE ENCASTRE

CONNECT		
E5049 62 cm	E5051 38 cm	E5053 48 cm

MATRIZ DE COMPATIBILIDAD

LAVABOS PARA MUEBLES

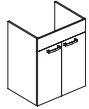
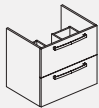
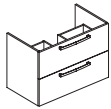
				CONNECT AIR		TESI		TEMPO	
				E028901	E027901	T351001	T350901	E066801	E066901
Serie	Muebles			60 cm	80 cm	60 cm	80 cm	60 cm	80 cm
TEMPO	Mueble 2 Puertas		E3239	<input checked="" type="checkbox"/>		<input checked="" type="checkbox"/>		<input checked="" type="checkbox"/>	
	Mueble 2 Cajones		E3240	<input checked="" type="checkbox"/>		<input checked="" type="checkbox"/>		<input checked="" type="checkbox"/>	
	Mueble 2 Cajones		E3242		<input checked="" type="checkbox"/>		<input checked="" type="checkbox"/>		<input checked="" type="checkbox"/>

ESPEJOS PARA MIRARSE Y RECREARSE EN UNO MISMO

Una gama completa de espejos para combinar con tus muebles.

CARACTERÍSTICAS TÉCNICAS ESPEJOS CON LUZ

Nombre colección	Ref.	Modelo	Tipo de iluminación	V	H	Clase	Protección IP	Eficiencia energética	Iluminación reemplazable
Espejos con dos luces	T3345BH	Espejo con luz LED 50 en la parte superior e inferior. Antivaho con regulador de intensidad	LED	200-240	35	Clase II	IP44	A+	No aplicable
Espejos con dos luces	T3346BH	Espejo con luz LED 60 en la parte superior e inferior. Antivaho con regulador de intensidad	LED	200-240	35	Clase II	IP44	A+	No aplicable
Espejos con dos luces	T3347BH	Espejo con luz LED 80 en la parte superior e inferior. Antivaho con regulador de intensidad	LED	200-240	40	Clase II	IP44	A+	No aplicable
Espejos con dos luces	T3348BH	Espejo con luz LED 100 en la parte superior e inferior. Antivaho con regulador de intensidad	LED	200-240	55	Clase II	IP44	A+	No aplicable
Espejos con dos luces	T3349BH	Espejo con luz LED 120 en la parte superior e inferior. Antivaho con regulador de intensidad	LED	200-240	55	Clase II	IP44	A+	No aplicable
Espejo con luz ambiental	T3339BH	Espejo con luz LED 50 en la parte superior integrado. Antivaho con regulador de intensidad	LED	200-240	30	Clase II	IP44	A+	No aplicable
Espejo con luz ambiental	T3340BH	Espejo con luz LED 60 en la parte superior integrado. Antivaho con regulador de intensidad	LED	200-240	30	Clase II	IP44	A+	No aplicable
Espejo con luz ambiental	T3341BH	Espejo con luz LED 70 en la parte superior integrado. Antivaho con regulador de intensidad	LED	200-240	30	Clase II	IP44	A+	No aplicable
Espejo con luz ambiental	T3342BH	Espejo con luz LED 80 en la parte superior integrado. Antivaho con regulador de intensidad	LED	200-240	30	Clase II	IP44	A+	No aplicable
Espejo con luz ambiental	T3343BH	Espejo con luz LED 100 en la parte superior integrado. Antivaho con regulador de intensidad	LED	200-240	60	Clase II	IP44	A+	No aplicable
Espejo con luz ambiental	T3344BH	Espejo con luz LED 120 en la parte superior integrado. Antivaho con regulador de intensidad	LED	200-240	65	Clase II	IP44	A+	No aplicable

CARACTERÍSTICAS TÉCNICAS LUCES

Nombre colección	Ref.	Modelo	Tipo de iluminación	V	W	H	Clase	Protección IP	Eficiencia energética
Aplique vertical	T3248AA	Aplique LED vertical	LED	230	6	50 - 60	Clase II	IP44	A+
Aplique horizontal 233 cm	T3189AA	Aplique LED horizontal 233	LED	230	6	50 - 60	Clase II	IP44	A+
Aplique horizontal 280 cm	T3190AA	Aplique LED horizontal 280	LED	230	6	50 - 60	Clase II	IP44	A+

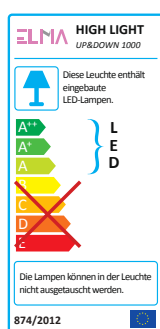

ETIQUETA DE CALIDAD

Todas nuestras luces vienen etiquetadas, cumpliendo con las normativas de energía que marca la comunidad europea de eficiencia energética.

Pueden descargar todas las etiquetas de eficiencia energética en este link: <https://www.idealstandard.com/energylabels>



INFORMACIÓN TÉCNICA

MUEBLES

Modernos, versátiles y funcionales. Un sinfín de posibilidades para encontrar la solución que necesitas confiriendo personalidad y carácter al espacio. Su diseño atractivo les permite integrarse de manera armónica en todos los ambientes.

MUEBLES



| MUEBLE MODULAR



| MUEBLE DE PUERTAS
Y CAJONES

MUEBLES

MUEBLE MODULAR ADAPTO

Adapto destaca por su practicidad y funcionalidad. Una colección innovadora y versátil que ofrece soluciones para optimizar el espacio de baño combinando elegancia, diseño y sencillez.





ADAPTO

MUEBLES Y ESPEJOS







INFORMACIÓN TÉCNICA **NOVEDAD**

ADAPTO

Su diseño sobrio de líneas rectas obtiene como resultado una propuesta de gran versatilidad que lo convierte en una opción ideal para diferentes ambientes de baño.

MUEBLES



ENCIMERAS



MÓDULOS

TAPA
ENCIMERA

ESENCIAL Y VERSÁTIL

Diseñado para máxima flexibilidad.

Encimeras, módulos, tapas de encimeras, estructuras laterales y toalleros disponibles. Oferta totalmente personalizada para módulos. Sistemas de patas disponibles para módulos standard. Cuatro acabados. Material de alta calidad con certificado FSC. Perfecto para proyectos de hoteles y residenciales. Fácil montaje.

COMBÍNALO COMO QUIERAS

Los módulos de la colección Adapto se pueden combinar para crear el diseño y la funcionalidad que tu proyecto requiere:

- 1- Selecciona el tamaño de la encimera.
- 2- Elige tu acabado.
- 3- Selecciona los componentes que necesitas para tu conjunto (toallero, estructura lateral...etc).



Blanco lacado

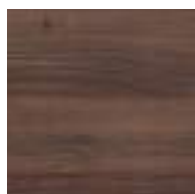

Nogal oscuro



Miel



Gris arenado



CARACTERÍSTICAS TÉCNICAS MUEBLES

Producto	Medidas	Construcción	Material	Herrajes	Acabados
Encimeras	60/70/85/ 105/120/150 x 50,5 x 12 cm	Sistema de plegado	MFC 19 mm de espesor HPL 10 mm	Soporte de pared ajustables	Blanco lacado Nogal oscuro Roble arenado Acabado cemento
Tapa encimera	60/70/85/ 105/120/150 x 50,5 x 12 cm		DF/MFC 1 2mm de espesor		Blanco lacado Nogal oscuro Roble arenado Acabado cemento
Modulos (Cajón con push to open)	25/50 x 50,5 x 24,5 mm	Unión a tope reforzada con tacos	Panel frontal lacado: MDF poliéster ter-revestido 19mm Panel frontal de melamina: MFC ther- mo-structured 19mm -Carcasa lacada: MFC 19mm Melamina en canal: MFC termoestructurado 19mm Cajón: Blum Tandembox Antaro + Blumotion panel base MFC 16mm de grosor"	Soporte para colgar: Herrajes Metal Domus 206-V Kit de fijación: Placa de accesorios Friulana + tornillo y tuerca	Blanco lacado Nogal oscuro Roble arenado Acabado cemento
Estructuras	60/85/105/120 mm + pata	Tornillos	Aluminio (barra de 15x15 mm)	kit de fijación (tornillos)	Gris oscuro cepillado
Toalleros	345/355/ 360/475	Curvada	Barra de aluminio brillante	kit de fijación (tornillos)	Acabado cromo brillante



ENCIMERA 60



Acabado		Ref.	€/Ud.	Stock	Cant.
	Encimera blanca lacada	U8405WG	300		10
	Encimera nogal oscuro	U8405FW	300		10
	Encimera miel	U8405FF	300		10
	Encimera gris arenado	U8405FX	300		10

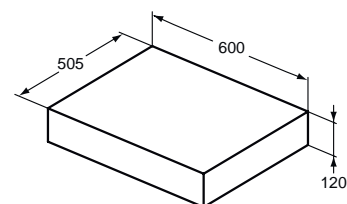

Descripción

- Compatible con bases suspendidas (U8419 e U8421) y toalleros
- Instalación suspendida con soportes de fijación (U842867) vendidos por separado
- Instalación independiente a través de la estructura específica (piernas U8599FY + barras de unión).
- Encimera suministrada sin corte para lavabo

ENCIMERA 70



Acabado		Ref.	€/Ud.	Stock	Cant.
	Encimera blanca lacada	U8406WG	325		10
	Encimera nogal oscuro	U8406FW	325		10
	Encimera miel	U8406FF	325		10
	Encimera gris arenado	U8406FX	325		10

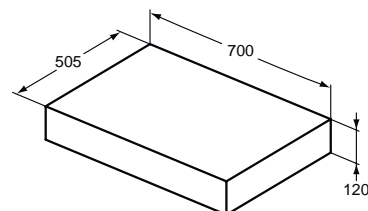

Descripción

- Compatible con bases suspendidas (U8419 e U8421) y toalleros
- Instalación suspendida con soportes de fijación (U842867) vendidos por separado
- Instalación independiente a través de la estructura específica (piernas U8599FY + barras de unión).
- Encimera suministrada sin corte para lavabo

ENCIMERA 85



Acabado		Ref.	€/Ud.	Stock	Cant.
	Encimera blanca lacada	U8407WG	350		10
	Encimera nogal oscuro	U8407FW	350		10
	Encimera miel	U8407FF	350		10
	Encimera gris arenado	U8407FX	350		10

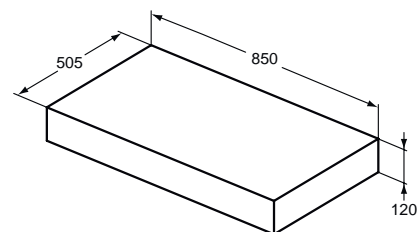

Descripción

- Compatible con bases suspendidas (U8419 e U8421) y toalleros
- Instalación suspendida con soportes de fijación (U842867) vendidos por separado
- Instalación independiente a través de la estructura específica (piernas U8599FY + barras de unión).
- Encimera suministrada sin corte para lavabo

ENCIMERA 105



Acabado	Ref.	€/Ud.	Stock	Cant.
 Encimera blanca lacada	U8408WG	400		10
 Encimera nogal oscuro	U8408FW	400		10
 Encimera miel	U8408FF	400		10
 Encimera gris arenado	U8408FX	400		10

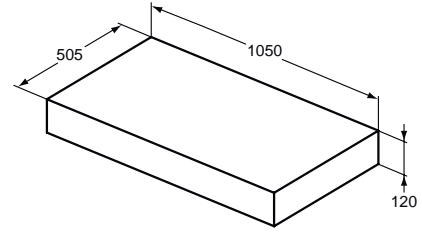

Descripción

- Compatible con bases suspendidas (U8419 e U8421) y toalleros
- Instalación suspendida con soportes de fijación (U842867) vendidos por separado
- Instalación independiente a través de la estructura específica (piernas U8599FY + barras de unión).
- Encimera suministrada sin corte para lavabo

ENCIMERA 120



Acabado	Ref.	€/Ud.	Stock	Cant.
 Encimera blanca lacada	U8409WG	450		10
 Encimera nogal oscuro	U8409FW	450		10
 Encimera miel	U8409FF	450		10
 Encimera gris arenado	U8409FX	450		10

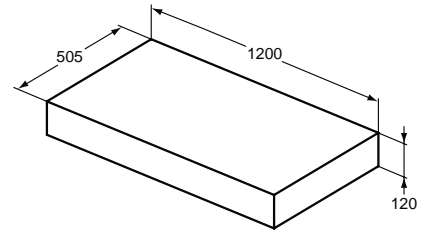

Descripción

- Compatible con bases suspendidas (U8419 e U8421) y toalleros
- Instalación suspendida con soportes de fijación (U842867) vendidos por separado
- Instalación independiente a través de la estructura específica (piernas U8599FY + barras de unión).
- Encimera suministrada sin corte para lavabo

ENCIMERA 150



Acabado	Ref.	€/Ud.	Stock	Cant.
 Encimera blanca lacada	U8593WG	500		10
 Encimera nogal oscuro	U8593FW	500		10
 Encimera miel	U8593FF	500		10
 Encimera gris arenado	U8593FX	500		10

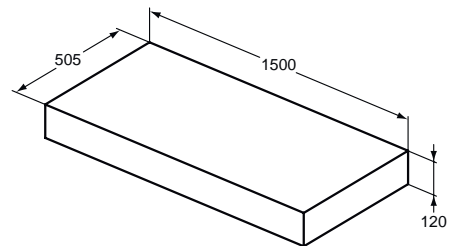

Descripción

- Compatible con bases suspendidas (U8419 e U8421) y toalleros
- Instalación suspendida con soportes de fijación (U842867) vendidos por separado
- Instalación independiente a través de la estructura específica (piernas U8599FY + barras de unión).
- Encimera suministrada sin corte para lavabo

MUEBLES ADAPTO



SOPORTE FIJACIÓN A PARED

Acabado: Cromado	Ref.	€/Ud.	Stock	Cant.
SopORTE fijación a pared	U842867	85		10

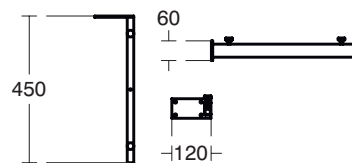

Descripción

- Para instalación suspendida de encimeras
- Para encimeras de hasta 1200 mm utilizar dos soportes
- Para encimeras de 1201 a 1500 mm utilizar tres soportes



PATA LATERAL

Acabado: Cromado	Ref.	€/Ud.	Stock	Cant.
Pata lateral de estructura	U8599FY	175		10

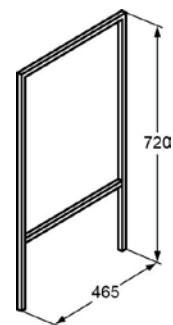

Descripción

- Para una instalación independiente que se combine con las barras de unión (U860xxx) a elegir de acuerdo con el tamaño de la repisa



BARRAS HORIZONTALES

Acabado: Cromado	Ref.	€/Ud.	Stock	Cant.
Estructura horizontal 600 mm	U8600FY	120		10
Estructura horizontal 850 mm	U8601FY	130		10
Estructura horizontal 1050 mm	U8602FY	150		10
Estructura horizontal 1200 mm	U8603FY	170		10

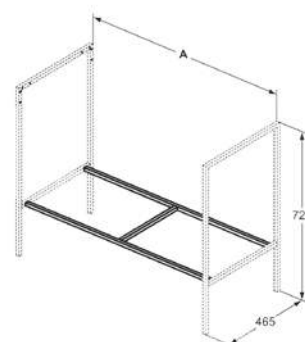

Descripción

- Para una instalación independiente que se combine con las barras de unión (U860xxx) a elegir de acuerdo con el tamaño de la repisa

	A
U8600FY	600
U8601FY	850
U8602FY	1050
U8603FY	1200

MODULO CAJÓN 25



Acabado		Ref.	€/Ud.	Stock	Cant.
	Módulo blanco lacado	U8419WG	300		10
	Módulo nogal oscuro	U8419FW	300		10
	Módulo miel	U8419FF	300		10
	Módulo gris arenado	U8419FX	300		10

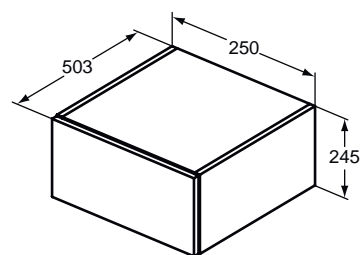

Descripción

- 1 cajón con apertura Push to Open
- Compatible con encimeras y tapas

MODULO CAJÓN 50



Acabado		Ref.	€/Ud.	Stock	Cant.
	Módulo blanco lacado	U8421WG	350		10
	Módulo nogal oscuro	U8421FW	350		10
	Módulo miel	U8421FF	350		10
	Módulo gris arenado	U8421FX	350		10

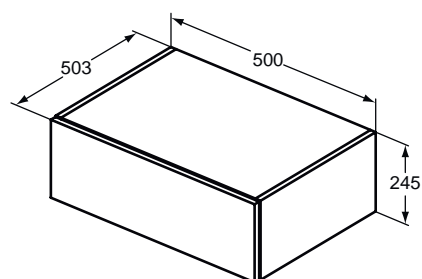

Descripción

- 1 cajón con apertura Push to Open
- Compatible con encimeras y tapas

TAPA ENCIMERA 25

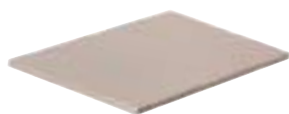

Acabado		Ref.	€/Ud.	Stock	Cant.
	Tapa blanca lacada	U8410WG	60		10
	Tapa nogal oscuro	U8410FW	60		10
	Tapa miel	U8410FF	60		10
	Tapa gris arenado	U8410FX	60		10

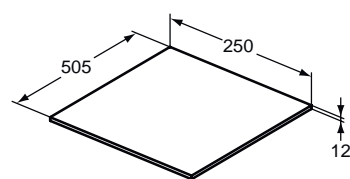

Descripción

- Compatible con encimeras y con soportes de fijación a pared para instalación independiente

TAPA ENCIMERA 50



Acabado		Ref.	€/Ud.	Stock	Cant.
	Tapa blanca lacada	U8412WG	120		10
	Tapa nogal oscuro	U8412FW	120		10
	Tapa miel	U8412FF	120		10
	Tapa gris arenado	U8412FX	120		10

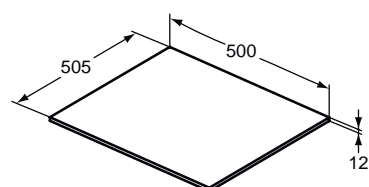

Descripción

- Compatible con encimeras y con soportes de fijación a pared para instalación independiente

MUEBLES ADAPTO

TAPA ENCIMERA 60



Acabado	Ref.	€/Ud.	Stock	Cant.
 Tapa blanca lacada	U8413WG	150		10
 Tapa nogal oscuro	U8413FW	150		10
 Tapa miel	U8413FF	150		10
 Tapa gris arenado	U8413FX	150		10

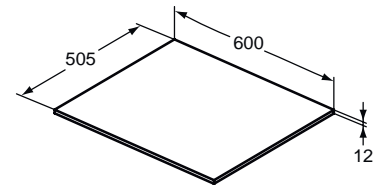

Descripción

Compatible con encimeras y con soportes de fijación a pared para instalación independiente

TAPA ENCIMERA 70



Acabado	Ref.	€/Ud.	Stock	Cant.
 Tapa blanca lacada	U8414WG	165		10
 Tapa nogal oscuro	U8414FW	165		10
 Tapa miel	U8414FF	165		10
 Tapa gris arenado	U8414FX	165		10

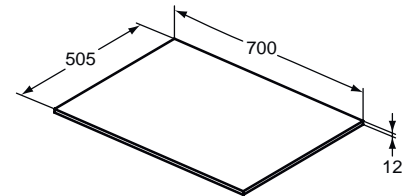

Descripción

Compatible con encimeras y con soportes de fijación a pared para instalación independiente

TAPA ENCIMERA 85



Acabado	Ref.	€/Ud.	Stock	Cant.
 Tapa blanca lacada	U8415WG	175		10
 Tapa nogal oscuro	U8415FW	175		10
 Tapa miel	U8415FF	175		10
 Tapa gris arenado	U8415FX	175		10

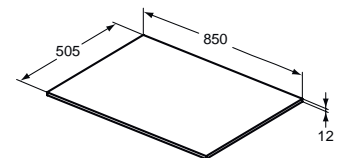

Descripción

Compatible con encimeras y con soportes de fijación a pared para instalación independiente

TAPA ENCIMERA 105



Acabado	Ref.	€/Ud.	Stock	Cant.
 Tapa blanca lacada	U8416WG	195		10
 Tapa nogal oscuro	U8416FW	195		10
 Tapa miel	U8416FF	195		10
 Tapa gris arenado	U8416FX	195		10

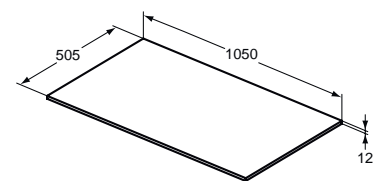

Descripción

Compatible con encimeras y con soportes de fijación a pared para instalación independiente

TAPA ENCIMERA 120



Acabado	Ref.	€/Ud.	Stock	Cant.
 Tapa blanca lacada	U8417WG	215		10
 Tapa nogal oscuro	U8417FW	215		10
 Tapa miel	U8417FF	215		10
 Tapa gris arenado	U8417FX	215		10

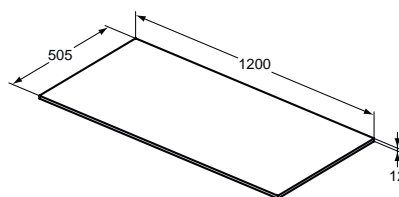

Descripción

Compatible con encimeras y con soportes de fijación a pared para instalación independiente

PORTATOALLAS



Acabado: Cromado	Ref.	€/Ud.	Stock	Cant.
Toallero 360mm	U8425AA	150		10
Toallero 355mm	U8426AA	150		10
Toallero 345mm	U8427AA	150		10
Toallero 475mm	U8615AA	150		10

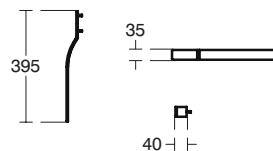

Descripción

· Compatible con bases suspendidas o con barras de unión para la instalación independiente

MUEBLES

MUEBLE PUERTAS Y CAJONES TEMPO

La sencillez de su estilo hacen de él el complemento perfecto para tu baño.







INFORMACIÓN TÉCNICA

TEMPO

Elegante, sencillo y equilibrado. Estructura cuadrículada para los que aman el orden y las formas simétricas y perfectas.

MUEBLES

MUEBLES
CON CAJONESMUEBLES
CON PUERTAS

I AUXILIARES

MARCANDO TIEMPOS EN EL BAÑO

Simplicidad, efectividad, practicidad: este es el lema de la colección Tempo pensado para perdurar en el tiempo.

Tempo está pensada para adaptarse a las necesidades del día a día. Con una gama de acabados de alta calidad en diferentes colores y texturas, que le darán un toque personal a su baño.



Blanco brillo



Roble arenado



Gris arenado



CARACTERÍSTICAS TÉCNICAS MUEBLES

Producto	Pieza	Descripción	Blanco materiales	Espesor	Acabados
Mueble	Estructura	Cantos pvc 1mm y 0,5mm para los acabados melamina.	Tablero de aglomerado	16 mm	Lacado Blanco brillo alto brillo o melaminas texturizadas roble arenado o gris arenado.
	Frontales	Cantos pvc 1mm y 0,5mm para los acabados melamina.	Tablero de aglomerado	16 mm	Lacado Blanco brillo alto brillo o melaminas texturizadas roble arenado o gris arenado.
	Cajón	Guías ocultas (Hettich Quadro) de extracción parcial y cierre con efecto amortiguado soft-close. Profundidad de los cajones 30cm.	Tablero de aglomerado		Melanina gris
	Tirador		Zamack		Cromado alto brillo
	Bisagras	Con cierre ralentizado soft-close. 105° de apertura. Con montaje rápido			
	Patas		Aluminio anodizado		Alto brillo
	Colgador	Montaje directo y regulable en altura			
	Columna	Con estantes de aglomerado melaminico regulables en altura. Sistema de fijacion oculto con regulacion vertical y horizontal. Fijacion adicional para extra seguridad			



MUEBLES TEMPO



MUEBLE 60 CON PUERTAS

Acabado	Ref.	€/Ud.	Stock	Cant.
Blanco brillo	E3239WG	115		10
Roble arenado	E3239OS	115		10
Gris arenado	E3239SG	115		10

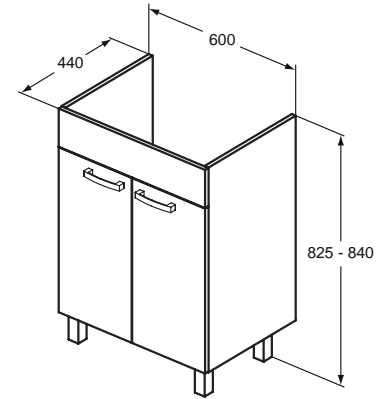

Descripción

- Mueble con patas
- 4 patas zamak efecto cromado incluidas
- 2 puertas con cierre amortiguado
- Exterior: lacado blanco y otros acabados en melamina
- Interior en melamina del mismo color que el acabado exterior
- Tirador metal cromo brillo incluido



MUEBLE 60 CON CAJONES

Acabado	Ref.	€/Ud.	Stock	Cant.
Blanco brillo	E3240WG	195	<input checked="" type="checkbox"/>	10
Roble arenado	E3240OS	195	<input checked="" type="checkbox"/>	10
Gris arenado	E3240SG	195	<input checked="" type="checkbox"/>	10

Características técnicas

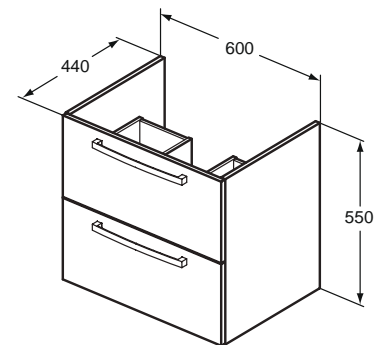

Descripción	Ref.	€/Ud.	Stock	Cant.
Juego de patas	E322867	32		10

Descripción

- Mueble suspendido
- 2 cajones con cierre amortiguado
- Exterior: lacado blanco y otros acabados en melamina
- Interior en melamina del mismo color que el acabado exterior
- Tirador metal cromo brillo incluido
- Patas no incluidas (opcionales)



MUEBLE 80 CON CAJONES

Acabado	Ref.	€/Ud.	Stock	Cant.
 Blanco brillo	E3242WG	270	<input checked="" type="checkbox"/>	10
 Roble arenado	E3242OS	270	<input checked="" type="checkbox"/>	10
 Gris arenado	E3242SG	270	<input checked="" type="checkbox"/>	10

Descripción	Ref.	€/Ud.	Stock	Cant.
Juego de patas	E322867	32		10

Descripción

- Mueble suspendido
- 2 cajones con cierre amortiguado
- Exterior: lacado blanco y otros acabados en melamina
- Interior en melamina del mismo color que el acabado exterior
- Tirador metal cromo brillo incluido
- Patas no incluidas (opcionales)

Características técnicas

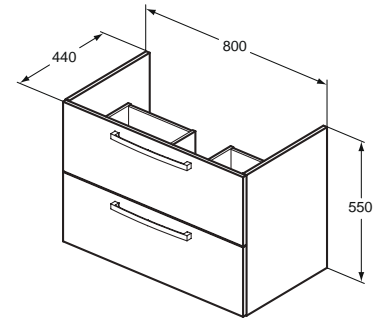

COLUMNA 40 AUXILIAR

Acabado	Ref.	€/Ud.	Stock	Cant.
 Blanco brillo	E3243WG	205		10
 Roble arenado	E3243OS	205		10
 Gris arenado	E3243SG	205		10

Descripción

- Mueble suspendido
- Dos puertas con cierre amortiguado reversibles.
- Exterior en lacado blanco brillo o en melamina para otros acabados tirador metal cromo brillo incluido
- Estante internos de melamina

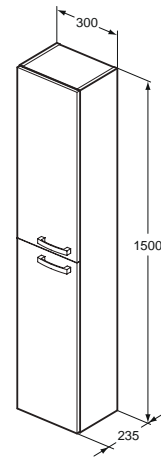

JUEGO DE PATAS

Acabado: Cromado	Ref.	€/Ud.	Stock	Cant.
Juego de patas	E322867	32		10

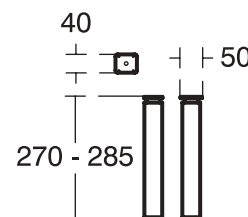

Descripción

- 2 piezas regulables en altura
- Opcional para los muebles con cajón



INFORMACIÓN TÉCNICA **NOVEDAD**

ESPEJOS Y LUMINARIAS

Un día a día más seguro y confortable a través de nuestro diseño funcional y elegante

ESPEJOS Y LUMINARIAS



ESPEJOS
CON LUCES



ESPEJOS



APLIQUES

MUEBLES Y ESPEJOS NOVEDAD ESPEJOS Y LUMINARIAS



ESPEJOS CON DOS LUCES

Acabado: Blanco Brillo	Ref.	€/Ud.	Stock	Cant.
Espejo rectangular 50x70 cm	T3345BH	410		6
Espejo rectangular 60x70 cm	T3346BH	455		6
Espejo rectangular 80x70 cm	T3347BH	495		6
Espejo rectangular 100x70 cm	T3348BH	525		6
Espejo rectangular 120x70 cm	T3349BH	600		6

- Luz LED en la parte superior e inferior
- Sistema antivaho integrado para un confort óptimo
- Grado de protección del espejo IP44, Clase II
- Espejo reversible
- Regulador de intensidad
- 200-240 V, 50HZ

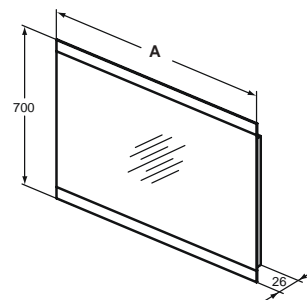

	A
T3345BH	500
T3346BH	600
T3347BH	800
T3348BH	1000
T3349BH	1200



ESPEJO CON LUZ AMBIENTAL

Acabado: Blanco Brillo	Ref.	€/Ud.	Stock	Cant.
Espejo rectangular 50x70 cm	T3339BH	300		6
Espejo rectangular 60x70 cm	T3340BH	415		6
Espejo rectangular 70x70 cm	T3341BH	425		6
Espejo rectangular 80x70 cm	T3342BH	450		6
Espejo rectangular 100x70 cm	T3343BH	475		6
Espejo rectangular 120x70 cm	T3344BH	550		6

- Luz LED en la parte superior integrado
- Sistema antivaho integrado para un confort óptimo
- Grado de protección del espejo IP44, Clase II
- Espejo reversible
- Regulador de intensidad
- 200-240 V, 50HZ

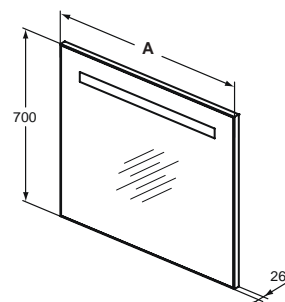

	A
T3339BH	500
T3340BH	600
T3341BH	700
T3342BH	800
T3343BH	1000
T3344BH	1200



ESPEJOS

Acabado: Blanco Brillo	Ref.	€/Ud.	Stock	Cant.
Espejo rectangular 50x70 cm	T3354BH	90		6
Espejo rectangular 60x70 cm	T3355BH	95		6
Espejo rectangular 70x70 cm	T3356BH	100		6
Espejo rectangular 80x70 cm	T3357BH	105		6
Espejo rectangular 100x70 cm	T3358BH	125		6
Espejo rectangular 120x70 cm	T3359BH	150		6

***Solo se pueden instalar iluminaciones sobre estos espejos**

- Espejo para instalación a pared
- Espejo reversible
- Espesor de 26 MM

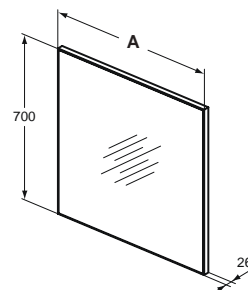

	A
T3354BH	500
T3355BH	600
T3356BH	700
T3357BH	800
T3358BH	1000
T3359BH	1200



APLIQUE VERTICAL

Acabado: Blanco Brillo	Ref.	€/Ud.	Stock	Cant.
Aplique LED vertical	T3248AA	30		6

*Estos apliques solo se pueden instalar sobre los espejos sin luz

- Luz de LED**
- Grado de protección del espejo IP44, Clase II
- 6W, 105 lumen y 4000 kelvin
- 230 V, 50-60 HZ
- Clase energetica A+

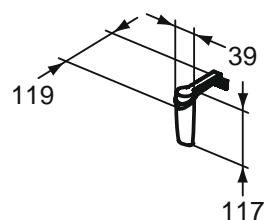

APLIQUE HORIZONTAL 233 CM



Acabado: Blanco Brillo	Ref.	€/Ud.	Stock	Cant.
Aplique LED horizontal 233 cm	T3189AA	50		6

*Estos apliques solo se pueden instalar sobre los espejos sin luz

- Luz de LED**
- Grado de protección del espejo IP44, Clase II
- 6W, 105 lumen y 4000 kelvin
- 230 V, 50-60 HZ
- Clase energetica A+

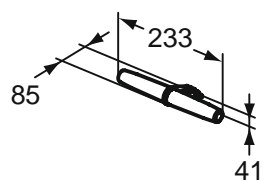

APLIQUE HORIZONTAL 280 CM



Acabado: Blanco Brillo	Ref.	€/Ud.	Stock	Cant.
Aplique LED horizontal 280 cm	T3190AA	70		6

*Estos apliques solo se pueden instalar sobre los espejos sin luz

- Luz de LED**
- Grado de protección del espejo IP44, Clase II
- 6W, 105 lumen y 4000 kelvin
- 230 V, 50-60 HZ
- Clase energetica A+

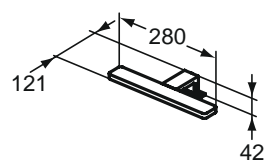

IDEAL STANDARD

WELLNESS

Reconecta con tu yo interior. Es hora de sumergirse en un mundo de tranquilidad, de burbujas y esencias relajantes, transformando tu baño en un suntuoso spa.

PLATOS DE DUCHA

326

BAÑERAS

354



IDEAL STANDARD

PLATOS DE DUCHA

TODO EN ELEGANCIA Y FORMAS PARA TU BAÑO

Múltiples acabados y texturas con las que dar carácter a tu baño sin renunciar a la máxima comodidad.





WELLNESS

Mampara no comercializada por Ideal Standard Iberia

PLATOS DE DUCHA

ULTRAFLAT S



WELLNESS



ULTRAFLAT S



Mampara no comercializada por Ideal Standard Iberia



NUEVAS TEXTURAS
Y COLORES PARA
DESCUBRIR...

PERSONALIZABLE

Los platos de ducha Ultraflat S se pueden personalizar para **satisfacer cualquier necesidad de espacio.**

PLATOS DE DUCHA

ULTRAFLAT



WELLNESS



Mampara no comercializada por Ideal Standard Iberia



WELLNESS

PLATOS DE DUCHA

INFORMACIÓN TÉCNICA

Una arquitectura de diseño para poder disfrutar tanto de una ducha rápida como de un momento relajante al final del día. Máxima comodidad y elegancia en tu rutina diaria.

PLATOS DE DUCHA RESINA ULTRAFLAT



PLATO DE DUCHA
CUADRADO

PLATOS DE DUCHA
RECTANGULARES

PLATOS DE DUCHA ACRÍLICOS ULTRAFLAT



PLATO DE DUCHA
CUADRADO

PLATO DE DUCHA
RECTANGULAR

PLATO DE DUCHA
ANGULAR



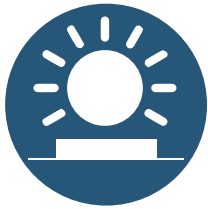
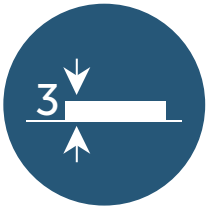

ULTRA FINO

La altura del plato de ducha se ha reducido a 3 cm.

RESISTENTE A LA VARIACIÓN DE LUZ

Los platos Ultraflat S resisten los daños causados por la luz. Han sido testados con lámparas de luz xenón, que producen de una manera acelerada los efectos medioambientales de envejecimiento que se muestran en condiciones reales (EN ISO 4892).

ANTISDESLIZANTE

Ultraflat S está en lo más alto de la normativa DIN 51097 (Clase C), evita el deslizamiento sobre superficies con inclinación superior a 24°.

HIGIÉNICO

Los platos Ultraflat S están provistos de elementos bacteriostáticos y fungicidas, que inhiben el crecimiento de las bacterias y hongos en la superficie del plato garantizando mayor seguridad e higiene.



EXCELENTES PRESTACIONES

RESISTENTE A LOS PRODUCTOS QUÍMICOS

Los platos de ducha Ultraflat S están sometidos a rigurosas pruebas de resistencia a productos químicos, y cumplen todas las pruebas requeridas por la norma EN 14527.

IDEAL SOLID®

Los platos de ducha Ultraflat S están provistos de un núcleo de mármol fundido (compuesto de minerales naturales y resina), recubierto con un esmalte técnico que le confiere un acabado opaco.

Este revestimiento (gelcoat 800 - 1000 µm) combina una excelente resistencia con plena recuperación de la superficie.

REPARABLE

En caso de arañazos y rasguños se pueden restaurar mediante un Kit especial de reparación.

PERSONALIZABLE

Los platos de ducha Ultraflat S pueden adaptarse a la necesidades específicas de cada cuarto de baño.

Sustancias que manchan	Tiempo de exposición	Resultado EN 14527
Ácido Acético	2 h	No se mancha permanente
Hidróxido de Sodio (Sosa Cáustica)	2 h	No se mancha permanente
Etanol (Alcohol Etilico)	2 h	No se mancha permanente
Hipoclorito sodio (Lejía)	2 h	No se mancha permanente
Azul di Metileno	2 h	No se mancha permanente

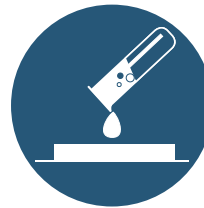
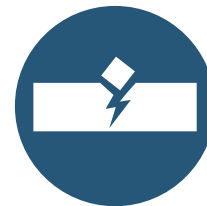
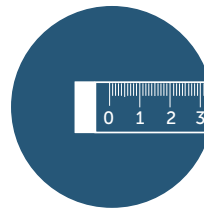

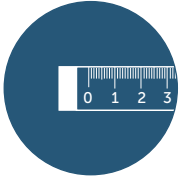

MEDIDA DE CORTE

Los platos de ducha Ultraflat S se pueden cortar tanto a lo largo como a lo ancho, pudiendo realizar rebajes para adaptarse a las limitaciones del espacio, tales como una columna.

No se puede hacer cortes alrededor del desagüe en un área de 40x40 cm.

El corte debe ser realizado por el profesional durante la instalación, siguiendo las instrucciones proporcionadas con el producto.

A continuación se presentan algunos ejemplos de personalización.

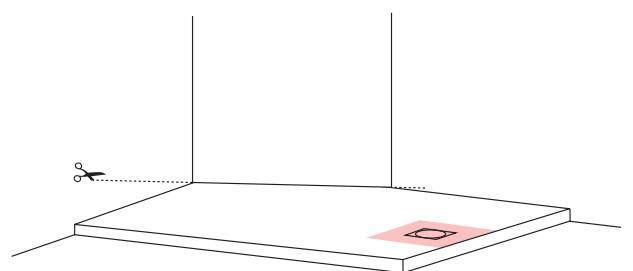
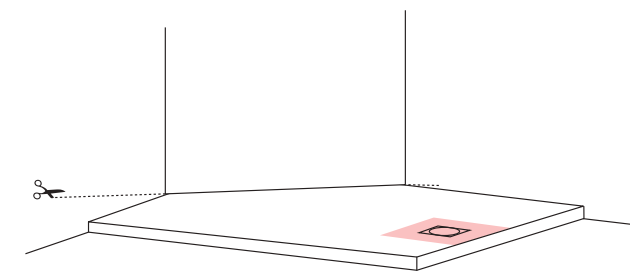
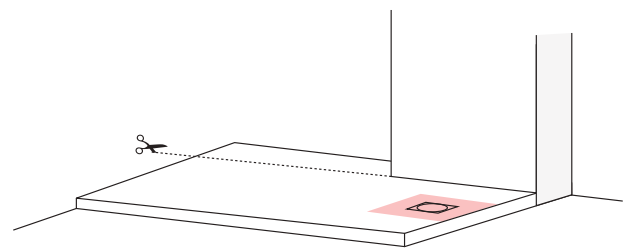
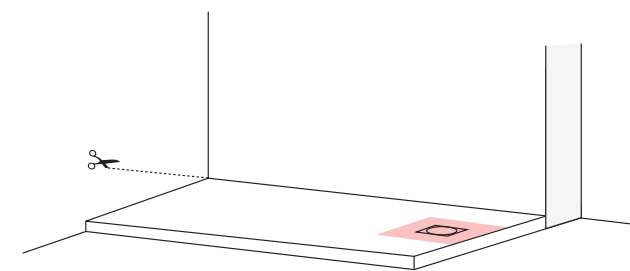
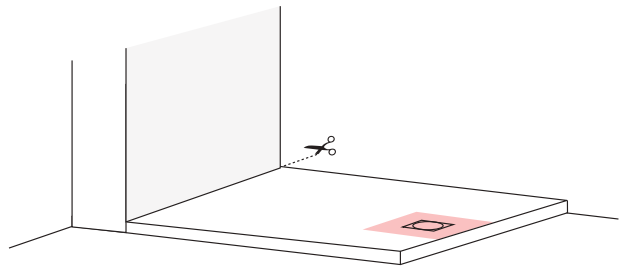
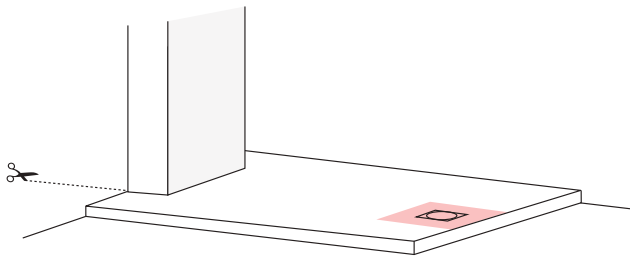
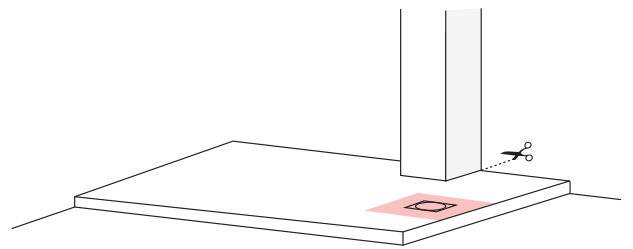
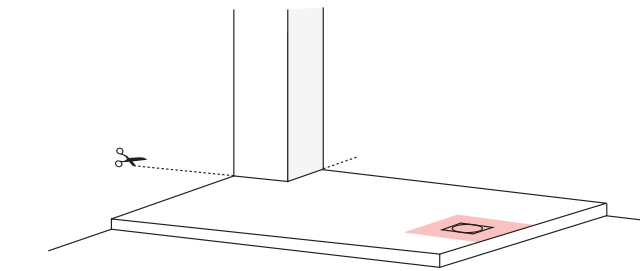

■ 40x40 cm - zona que no se puede cortar



Mampara no comercializada por Ideal Standard Iberia

WELLNESS

PERSONALIZABLE

Los platos de ducha Ultraflat S se pueden personalizar para **satisfacer cualquier necesidad de espacio.**





Desagües de colores

Los desagües se suministran en cromo y están disponibles en mismo color que el plato de ducha, una elegante combinación de tono sobre tono.

PLATOS DE DUCHA ULTRAFLAT S





ULTRAFLAT S CUADRADO

PLATO RESINA 80 X 80

Acabado	Ref.	€/Ud.	Stock	Cant.
 Blanco	K8214FR	300		6
 Arena	K8214FT	300		6
 Gris	K8214FS	300		6
 Moca	K8214FU	300		6
 Negro	K8214FV	300		6





* Válvula desagüe no incluida

PLATO RESINA 90 X 90

Acabado	Ref.	€/Ud.	Stock	Cant.
 Blanco	K8215FR	335		6
 Arena	K8215FT	335		6
 Gris	K8215FS	335		6
 Moca	K8215FU	335		6
 Negro	K8215FV	335		6

* Válvula desagüe no incluida

PLATO RESINA 100 X 100

Acabado	Ref.	€/Ud.	Stock	Cant.
 Blanco	K8216FR	425		6
 Arena	K8216FT	425		6
 Gris	K8216FS	425		6
 Moca	K8216FU	425		6
 Negro	K8216FV	425		6

* Válvula desagüe no incluida

Opcional:	Ref.	€/Ud.	Stock	Cant.
Válvula desagüe Ø 90mm	K936367	45		6
Juego 6 patas	K936467	60		6

Características técnicas

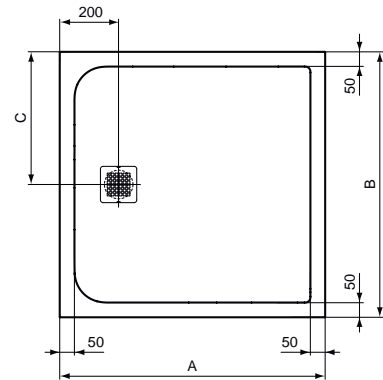
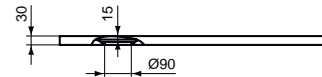

	A	B	C
K8216	1000	1000	500
K8215	900	900	450
K8214	800	800	450



K8214FR



K8215FR



K8216FR

Descripción

- Plato de ducha ultra-delgado
- IDEAL SOLID® material altamente resistente hecho de una mezcla de minerales naturales y resinas. Efecto piedra mate.
- Disponible en 5 colores.
- Rejilla de desagüe, en acero inoxidable
- **Válvula desagüe no incluida K936367,**
- El plato de ducha se puede instalar sobre el suelo o nivel del suelo.
- Juego de patas no incluido K936467
- Para platos hasta 100cm es suficiente con un único juego, para medidas mayores de 100cm se recomiendan 2 juegos



ULTRAFLAT S RECTANGULAR

PLATO RESINA 90 X 70

Acabado	Ref.	€/Ud.	Stock	Cant.
Blanco	K8190FR	270		6
Arena	K8190FT	270		6
Gris	K8190FS	270		6
Moca	K8190FU	270		6
Negro	K8190FV	270		6

* Válvula desagüe no incluida

PLATO RESINA 100 X 70

Acabado	Ref.	€/Ud.	Stock	Cant.
Blanco	K8218FR	340		6
Arena	K8218FT	340		6
Gris	K8218FS	340		6
Moca	K8218FU	340		6
Negro	K8218FV	340		6

* Válvula desagüe no incluida

PLATO RESINA 100 X 80

Acabado	Ref.	€/Ud.	Stock	Cant.
Blanco	K8219FR	355		6
Arena	K8219FT	355		6
Gris	K8219FS	355		6
Moca	K8219FU	355		6
Negro	K8219FV	355		6

* Válvula desagüe no incluida

PLATO RESINA 100 X 90

Acabado	Ref.	€/Ud.	Stock	Cant.
Blanco	K8220FR	385		6
Arena	K8220FT	385		6
Gris	K8220FS	385		6
Moca	K8220FU	385		6
Negro	K8220FV	385		6

* Válvula desagüe no incluida

Opcional:	Ref.	€/Ud.	Stock	Cant.
Válvula desagüe Ø 90mm	K936367	45		6
Juego 6 patas	K936467	60		6

Características técnicas

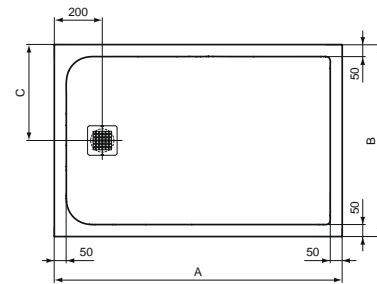
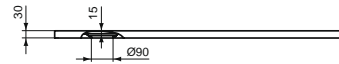

	A	B	C
K8129	900	700	350
K8218	1000	700	350
K8219	1000	800	400
K8220	1000	900	450



K8190FR



K8218FR



K8219FR



K8219FR



Descripción

- Plato de ducha ultra-delgado
- IDEAL SOLID® material altamente resistente hecho de una mezcla de minerales naturales y resinas. Efecto piedra mate.
- Disponible en 5 colores.
- Rejilla de desagüe, en acero inoxidable
- **Válvula desagüe no incluida K936367,**
- El plato de ducha se puede instalar sobre el suelo o nivel del suelo.
- Juego de patas no incluido K936467
- Para platos hasta 100cm es suficiente con un único juego, para medidas mayores de 100cm se recomiendan 2 juegos

PLATOS DE DUCHA ULTRAFLAT S





ULTRAFLAT S RECTANGULAR

PLATO RESINA 120 X 70

Acabado	Ref.	€/Ud.	Stock	Cant.
 Blanco	K8221FR	380		6
 Arena	K8221FT	380		6
 Gris	K8221FS	380		6
 Moca	K8221FU	380		6
 Negro	K8221FV	380		6

* Válvula desagüe no incluida

PLATO RESINA 120 X 80

Acabado	Ref.	€/Ud.	Stock	Cant.
 Blanco	K8227FR	425		6
 Arena	K8227FT	425		6
 Gris	K8227FS	425		6
 Moca	K8227FU	425		6
 Negro	K8227FV	425		6



* Válvula desagüe no incluida

PLATO RESINA 120 X 90

Acabado	Ref.	€/Ud.	Stock	Cant.
 Blanco	K8230FR	485		6
 Arena	K8230FT	485		6
 Gris	K8230FS	485		6
 Moca	K8230FU	485		6
 Negro	K8230FV	485		6

* Válvula desagüe no incluida

PLATO RESINA 120 X 100

Acabado	Ref.	€/Ud.	Stock	Cant.
 Blanco	K8232FR	525		6
 Arena	K8232FT	525		6
 Gris	K8232FS	525		6
 Moca	K8232FU	525		6
 Negro	K8232FV	525		6

* Válvula desagüe no incluida

Opcional:	Ref.	€/Ud.	Stock	Cant.
Válvula desagüe Ø 90mm	K936367	45		6
Juego 6 patas	K936467	60		6

Características técnicas

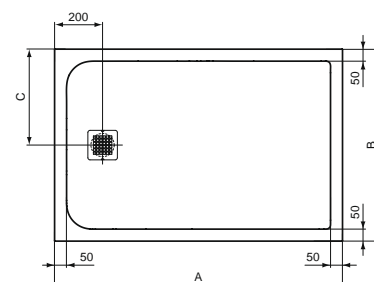
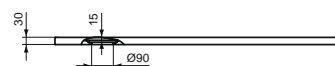

	A	B	C
K8227	1200	800	400
K8221	1200	700	350
K8230	1200	900	450
K8232	1200	1000	500



K8221FR



K8227FR



K8230FR



K8232FR

Descripción

- Plato de ducha ultra-delgado
- IDEAL SOLID® material altamente resistente hecho de una mezcla de minerales naturales y resinas. Efecto piedra mate.
- Disponible en 5 colores.
- Rejilla de desagüe, en acero inoxidable
- **Válvula desagüe no incluida K936367,**
- El plato de ducha se puede instalar sobre el suelo o nivel del suelo.
- Juego de patas no incluido K936467
- Para platos hasta 100cm es suficiente con un único juego, para medidas mayores de 100cm se recomiendan 2 juegos

ULTRAFLAT S RECTANGULAR

PLATO RESINA 140 X 70

Acabado	Ref.	€/Ud.	Stock	Cant.
Blanco	K8234FR	425		6
Arena	K8234FT	425		6
Gris	K8234FS	425		6
Moca	K8234FU	425		6
Negro	K8234FV	425		6

* Válvula desagüe no incluida

PLATO RESINA 140 X 80

Acabado	Ref.	€/Ud.	Stock	Cant.
Blanco	K8237FR	480		6
Arena	K8237FT	480		6
Gris	K8237FS	480		6
Moca	K8237FU	480		6
Negro	K8237FV	480		6

* Válvula desagüe no incluida

PLATO RESINA 140 X 90

Acabado	Ref.	€/Ud.	Stock	Cant.
Blanco	K8256FR	550		6
Arena	K8256FT	550		6
Gris	K8256FS	550		6
Moca	K8256FU	550		6
Negro	K8256FV	550		6

* Válvula desagüe no incluida

Opcional:	Ref.	€/Ud.	Stock	Cant.
Válvula desagüe Ø 90mm	K936367	45		6
Juego 6 patas	K936467	60		6

Características técnicas

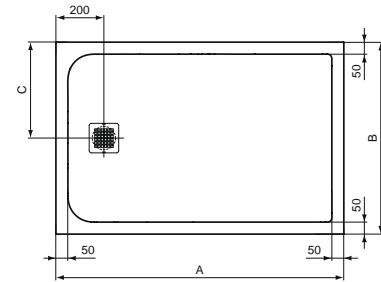
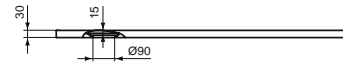

	A	B	C
K8234	1400	700	350
K8237	1400	800	400
K8256	1400	900	450



K8234FR



K8237FR



K8256FR

Descripción





- Plato de ducha ultra-delgado
- IDEAL SOLID® material altamente resistente hecho de una mezcla de minerales naturales y resinas. Efecto piedra mate.
- Disponible en 5 colores.
- Rejilla de desagüe, en acero inoxidable
- **Válvula desagüe no incluida K936367,**
- El plato de ducha se puede instalar sobre el suelo o nivel del suelo.
- Juego de patas no incluido K936467
- Para platos hasta 100cm es suficiente con un único juego, para medidas mayores de 100cm se recomiendan 2 juegos



PLATOS DE DUCHA ULTRAFLAT S





ULTRAFLAT S RECTANGULAR

PLATO RESINA 160 X 80

Acabado	Ref.	€/Ud.	Stock	Cant.
 Blanco	K8276FR	535		6
 Arena	K8276FT	535		6
 Gris	K8276FS	535		6
 Moca	K8276FU	535		6
 Negro	K8276FV	535		6





* Válvula desagüe no incluida

PLATO RESINA 160 X 90

Acabado	Ref.	€/Ud.	Stock	Cant.
 Blanco	K8277FR	655		6
 Arena	K8277FT	655		6
 Gris	K8277FS	655		6
 Moca	K8277FU	655		6
 Negro	K8277FV	655		6

* Válvula desagüe no incluida

PLATO RESINA 160 X 100 **NOVEDAD**

Acabado	Ref.	€/Ud.	Stock	Cant.
 Blanco	K8319FR	675		6
 Arena	K8319FT	675		6
 Gris	K8319FS	675		6
 Moca	K8319FU	675		6
 Negro	K8319FV	675		6

* Válvula desagüe no incluida

Opcional:	Ref.	€/Ud.	Stock	Cant.
Válvula desagüe Ø 90mm	K936367	45		6
Juego 6 patas	K936467	60		6

Características técnicas

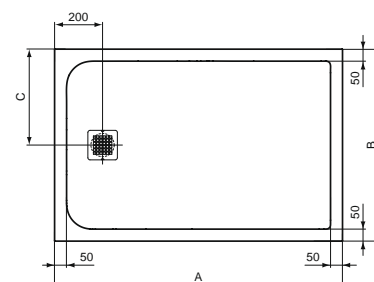
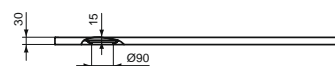

	A	B	C
K8276	1600	800	400
K8277	1600	900	450
K8319	1600	1000	500



K8276FR



K8277FR



K8319FR

Descripción

- Plato de ducha ultra-delgado
- IDEAL SOLID® material altamente resistente hecho de una mezcla de minerales naturales y resinas. Efecto piedra mate.
- Disponible en 5 colores.
- Rejilla de desagüe, en acero inoxidable

· **Válvula desagüe no incluida K936367,**

· El plato de ducha se puede instalar sobre el suelo o nivel del suelo.

· Juego de patas no incluido K936467

· Para platos hasta 100cm es suficiente con un único juego, para medidas mayores de 100cm se recomiendan 2 juegos



ULTRAFLAT S RECTANGULAR

PLATO RESINA 170 X 70

Acabado	Ref.	€/Ud.	Stock	Cant.
Blanco	K8281FR	515		6
Arena	K8281FT	515		6
Gris	K8281FS	515		6
Moca	K8281FU	515		6
Negro	K8281FV	515		6

* Válvula desagüe no incluida

PLATO RESINA 170 X 80

Acabado	Ref.	€/Ud.	Stock	Cant.
Blanco	K8284FR	575		6
Arena	K8284FT	575		6
Gris	K8284FS	575		6
Moca	K8284FU	575		6
Negro	K8284FV	575		6

* Válvula desagüe no incluida

PLATO RESINA 170 X 90

Acabado	Ref.	€/Ud.	Stock	Cant.
Blanco	K8285FR	655		6
Arena	K8285FT	655		6
Gris	K8285FS	655		6
Moca	K8285FU	655		6
Negro	K8285FV	655		6

* Válvula desagüe no incluida

Opcional:	Ref.	€/Ud.	Stock	Cant.
Válvula desagüe Ø 90mm	K936367	45		6
Juego 6 patas	K936467	60		6

Características técnicas

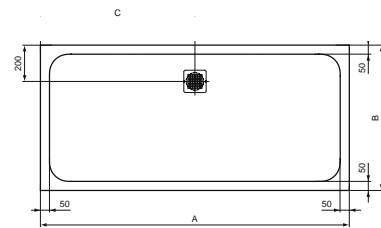
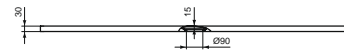

	A	B	C
K8281	1700	700	850
K8284	1700	800	850
K8285	1700	900	850



K8281FR



K8284FR



K8285FR

Descripción



- Plato de ducha ultra-delgado
- IDEAL SOLID® material altamente resistente hecho de una mezcla de minerales naturales y resinas. Efecto piedra mate.
- Disponible en 5 colores.
- Rejilla de desagüe, en acero inoxidable
- **Válvula desagüe no incluida K936367,**
- El plato de ducha se puede instalar sobre el suelo o nivel del suelo.
- Juego de patas no incluido K936467
- Para platos hasta 100cm es suficiente con un único juego, para medidas mayores de 100cm se recomiendan 2 juegos



PLATOS DE DUCHA ULTRAFLAT S

ULTRAFLAT S RECTANGULAR

PLATO RESINA 180 X 80

Acabado	Ref.	€/Ud.	Stock	Cant.
 Blanco	K8304FR	600		6
 Arena	K8304FT	600		6
 Gris	K8304FS	600		6
 Moca	K8304FU	600		6
 Negro	K8304FV	600		6





* Válvula desagüe no incluida

PLATO RESINA 180 X 90

Acabado	Ref.	€/Ud.	Stock	Cant.
 Blanco	K8306FR	700		6
 Arena	K8306FT	700		6
 Gris	K8306FS	700		6
 Moca	K8306FU	700		6
 Negro	K8306FV	700		6

* Válvula desagüe no incluida

PLATO RESINA 180 X 100 **NOVEDAD**

Acabado	Ref.	€/Ud.	Stock	Cant.
 Blanco	K8320FR	725		6
 Arena	K8320FT	725		6
 Gris	K8320FS	725		6
 Moca	K8320FU	725		6
 Negro	K8320FV	725		6

* Válvula desagüe no incluida

Opcional:	Ref.	€/Ud.	Stock	Cant.
Válvula desagüe Ø 90mm	K936367	45		6
Juego 6 patas	K936467	60		6

Características técnicas

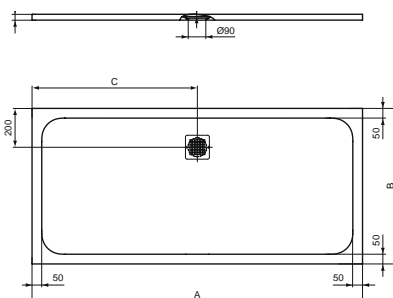

	A	B	C
K8304	1800	800	900
K8306	1800	900	900
K8320	1800	1000	900



K8304FR



K8306FR



K8320FR

Descripción





- Plato de ducha ultra-delgado
- IDEAL SOLID® material altamente resistente hecho de una mezcla de minerales naturales y resinas. Efecto piedra mate.
- Disponible en 5 colores.
- Rejilla de desagüe, en acero inoxidable
- **Válvula desagüe no incluida K936367,**
- El plato de ducha se puede instalar sobre el suelo o nivel del suelo.
- Juego de patas no incluido K936467
- Para platos hasta 100cm es suficiente con un único juego, para medidas mayores de 100cm se recomiendan 2 juegos



PLATOS DE DUCHA ACCESORIOS

TAPA

TAPA ULTRAFLAT S

Acabado	Ref.	€/Ud.	Stock	Cant.
 Blanco	KV169FR	25		6
 Arena	KV169FT	25		6
 Gris	KV169FS	25		6
 Moca	KV169FU	25		6
 Negro	KV169FV	25		6



OPCIONAL TAPA DESAGÜE:

Si se requiere con el mismo acabado que el plato, de serie se sirve cromado

VÁLVULA DESAGÜE

Acabado: Neutro	Ref.	€/Ud.	Stock	Cant.
Válvula normal Ultraflat S	K936367	45		6

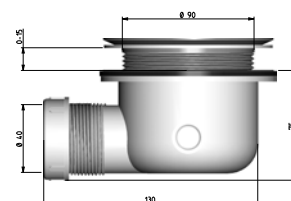

JUEGO DE PATAS

Acabado: Neutro	Ref.	€/Ud.	Stock	Cant.
Juego de 6 patas	K936467	60		6

Descripción

· Para platos hasta 100cm es suficiente con un único juego, para medidas mayores de 100cm se recomiendan 2 juegos



PLATOS DE DUCHA ULTRAFLAT

ULTRAFLAT CUADRADO

Acabado: Blanco Brillo	Ref.	€/Ud.	Stock	Cant.
70 x 70	K193301	138	<input checked="" type="checkbox"/>	6
80 x 80	K517201	143	<input checked="" type="checkbox"/>	6
90 x 90	K517301	161	<input checked="" type="checkbox"/>	6
100 x 100	K517401	204		6
120 x 120	K517501	227	<input checked="" type="checkbox"/>	6

* Válvula desagüe no incluida

Acabado: Blanco con tratamiento antideslizante	Ref.	€/Ud.	Stock	Cant.
70 x 70	K1933YK	196		6
80 x 80	K5172YK	203		6
90 x 90	K5173YK	221		6
100 x 100	K5174YK	263		6
120 x 120	K5175YK	287		6

* Válvula desagüe no incluida



IMPORTANTE: Plazo aproximado entrega de 4 semanas para el acabado antideslizante. No se recomienda su instalación en instalaciones no residenciales (hoteles, hospitales) dada su alta frecuencia de limpieza con productos industriales altamente concentrados.

Válvulas desagüe:	Ref.	€/Ud.	Stock	Cant.
Normal Ø 90mm	J3417AA	26	<input checked="" type="checkbox"/>	6
Plana Ø 90mm	T8520AA	41		6

Características técnicas

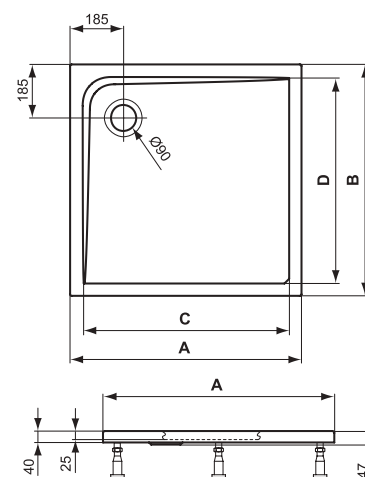

	A	B	C	D
K1933	700	700	585	585
K5172	800	800	675	675
K5173	900	900	785	785
K5174	1000	1000	875	875
K5175	1200	1200	1075	1075

ULTRAFLAT ANGULAR

Acabado: Blanco Brillo	Ref.	€/Ud.	Stock	Cant.
80 x 80	K193901	139	<input checked="" type="checkbox"/>	6
90 x 90	K517601	167	<input checked="" type="checkbox"/>	6
100 x 100	K517701	248		6

* Válvula desagüe no incluida

Acabado: Blanco con tratamiento antideslizante	Ref.	€/Ud.	Stock	Cant.
80 x 80	K1939YK	197		6
90 x 90	K5176YK	226		6
100 x 100	K5177YK	308		6

* Válvula desagüe no incluida



IMPORTANTE: Plazo aproximado entrega de 4 semanas para el acabado antideslizante. No se recomienda su instalación en instalaciones no residenciales (hoteles, hospitales) dada su alta frecuencia de limpieza con productos industriales altamente concentrados.

Válvulas desagüe:	Ref.	€/Ud.	Stock	Cant.
Normal Ø 90mm	J3417AA	26	<input checked="" type="checkbox"/>	6
Plana Ø 90mm	T8520AA	41		6

Características técnicas

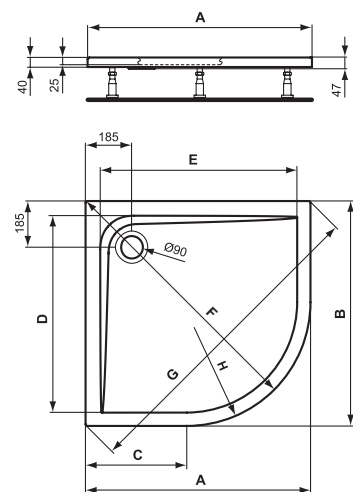

	A	B	C	D	E	F	G	H
K1939	800	800	300	685	685	924	1130	550
K5176	900	900	350	785	785	1065	1270	550
K5177	1000	1000	450	875	875	1185	1410	550



Descripción

- Acrílico
- Tipos de instalación:
 - Encastado
 - Sobre el suelo
 - Levantado con Styropor para crear una especie soporte
- 4 cm de espesor
- **Importante:** Los platos de ducha con acabado IdealGrip no se recomiendan en instalaciones no residenciales (hoteles, hospitales) dada su alta frecuencia de limpieza con productos industriales altamente concentrados.
- Lado accesible con proyección interna y externa de 2 cm máximo en la entrada. Conforme con el reglamento de accesibilidad (ley del 11/02/2005)



Descripción

- Acrílico
- Tipos de instalación:
 - Encastado
 - Sobre el suelo
 - Levantado con Styropor para crear una especie soporte
- 4 cm de espesor
- **Importante:** Los platos de ducha con acabado IdealGrip no se recomiendan en instalaciones no residenciales (hoteles, hospitales) dada su alta frecuencia de limpieza con productos industriales altamente concentrados.
- Lado accesible con proyección interna y externa de 2 cm máximo en la entrada. Conforme con el reglamento de accesibilidad (ley del 11/02/2005)

ULTRAFLAT RECTANGULAR



K193401



K1934YK



K193601



K2551YK

Descripción

- Acrílico
- Tipos de instalación:
 - Encastrado
 - Sobre el suelo
 - Levantado con Styropor para crear una especie soporte
- 4 cm de espesor
- **Importante:** Los platos de ducha con acabado IdealGrip no se recomiendan en instalaciones no residenciales (hoteles, hospitales) dada su alta frecuencia de limpieza con productos industriales altamente concentrados.
- Lado accesible con proyección interna y externa de 2 cm máximo en la entrada. Conforme con el reglamento de accesibilidad (Ley del 11/02/2005)

Acabado: Blanco Brillo	Ref.	€/Ud.	Stock	Cant.
90 x 70	K193401	156	<input checked="" type="checkbox"/>	6
90 x 75	K517901	163	<input checked="" type="checkbox"/>	6
90 x 80	K517801	168	<input checked="" type="checkbox"/>	6
100 x 70	K193501	173	<input checked="" type="checkbox"/>	6
100 x 80	K518001	215	<input checked="" type="checkbox"/>	6
100 x 90	K518101	239	<input checked="" type="checkbox"/>	6

* Válvula desagüe no incluida

Acabado: Blanco con tratamiento antideslizante	Ref.	€/Ud.	Stock	Cant.
90 x 70	K1934YK	216		6
90 x 75	K5179YK	222		6
90 x 80	K5178YK	277		6
100 x 70	K1935YK	232		6
100 x 80	K5180YK	275		6
100 x 90	K5181YK	298		6

* Válvula desagüe no incluida

Acabado: Blanco Brillo	Ref.	€/Ud.	Stock	Cant.
120 x 70	K193601	232	<input checked="" type="checkbox"/>	6
120 x 80	K518201	245	<input checked="" type="checkbox"/>	6
120 x 90	K518301	268	<input checked="" type="checkbox"/>	6
120 x 100	K518401	280		6
140 x 70	K193701	292	<input checked="" type="checkbox"/>	6
140 x 80	K518501	297	<input checked="" type="checkbox"/>	6
140 x 90	K518601	303	<input checked="" type="checkbox"/>	6
140 x 100	K255101	319		6

* Válvula desagüe no incluida

Acabado: Blanco con tratamiento antideslizante	Ref.	€/Ud.	Stock	Cant.
140 x 100	K2551YK	379		6
140 x 90	K5186YK	363		6
140 x 80	K5185YK	357		6
140 x 70	K1937YK	352		6
120 x 100	K5184YK	339		6
120 x 90	K5183YK	328		6
120 x 80	K5182YK	303		6
120 x 70	K1936YK	298		6

* Válvula desagüe no incluida

¡ **IMPORTANTE:** Plazo aproximado entrega de 4 semanas para el acabado antideslizante. No se recomienda su instalación en instalaciones no residenciales (hoteles, hospitales) dada su alta frecuencia de limpieza con productos industriales altamente concentrados.

Válvulas desagüe:	Ref.	€/Ud.	Stock	Cant.
Normal Ø 90mm	J3417AA	26	<input checked="" type="checkbox"/>	6
Plana Ø 90mm	T8520AA	41		6

Características técnicas

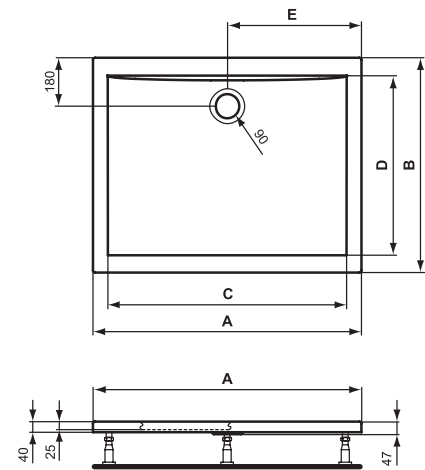

	A	B	C	D	E
K1934	900	700	790	560	450
K5179	900	750	774	610	450
K5178	900	800	774	610	450
K1935	1000	700	890	560	500
K5180	1000	800	884	660	500
K5181	1000	900	878	760	500

	A	B	C	D	E
K1936	1200	700	1090	560	600
K5182	1200	800	1088	660	600
K5183	1200	900	1090	760	600
K5184	1200	1000	1078	860	600
K1937	1400	700	1290	560	700
K5185	1400	800	1286	660	700
K5186	1400	900	1290	760	700
K2551	1400	1000	1285	770	700

PLATOS DE DUCHA ACRÍLICOS ULTRAFLAT

ULTRAFLAT RECTANGULAR

Acabado: Blanco Brillo	Ref.	€/Ud.	Stock	Cant.
160 x 70	K818701	297	<input checked="" type="checkbox"/>	6
160 x 80	K518701	311	<input checked="" type="checkbox"/>	6
160 x 90	K518801	319	<input checked="" type="checkbox"/>	6
160 x 100	K255201	340		6
170 x 70	K193801	319	<input checked="" type="checkbox"/>	6
170 x 80	K518901	330	<input checked="" type="checkbox"/>	6
170 x 90	K519001	339	<input checked="" type="checkbox"/>	6
170 x 100	K255301	362	<input checked="" type="checkbox"/>	6

* Válvula desagüe no incluida

Acabado: Blanco con tratamiento antideslizante	Ref.	€/Ud.	Stock	Cant.
160 x 70	K8187YK	357		6
160 x 80	K5187YK	370		6
160 x 90	K5188YK	379		6
160 x 100	K2552YK	400		6
170 x 70	K1938YK	379		6
170 x 80	K5189YK	390		6
170 x 90	K5190YK	399		6
170 x 100	K2553YK	422		6

* Válvula desagüe no incluida

Acabado: Blanco Brillo	Ref.	€/Ud.	Stock	Cant.
180 x 80	K519101	353	<input checked="" type="checkbox"/>	6
180 x 90	K519201	363	<input checked="" type="checkbox"/>	6
180 x 100	K255401	379		6

* Válvula desagüe no incluida

Acabado: Blanco con tratamiento antideslizante	Ref.	€/Ud.	Stock	Cant.
180 x 80	K5191YK	412		6
180 x 90	K5192YK	423		6
180 x 100	K2554YK	438		6

* Válvula desagüe no incluida

Válvulas desagüe:	Ref.	€/Ud.	Stock	Cant.
Normal Ø 90mm	J3417AA	26	<input checked="" type="checkbox"/>	6
Plana Ø 90mm	T8520AA	41		6



IMPORTANTE: Plazo aproximado entrega de 4 semanas para el acabado antideslizante. No se recomienda su instalación en instalaciones no residenciales (hoteles, hospitales) dada su alta frecuencia de limpieza con productos industriales altamente concentrados.

Características técnicas

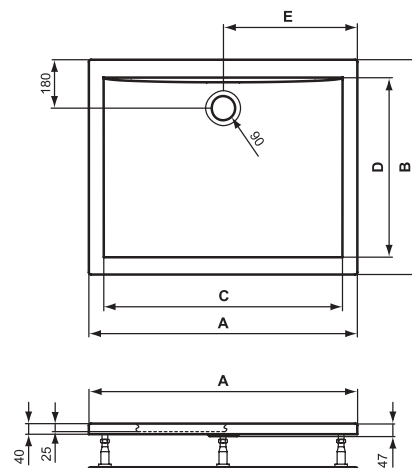

	A	B	C	D	E
K8187	1600	700	1486	560	800
K5187	1600	800	1486	660	800
K5188	1600	900	1490	760	800
K2552	1600	1000	1485	770	850
K1938	1700	700	1590	650	850
K5189	1700	800	1586	660	850
K5190	1700	900	1590	760	850
K2553	1700	1000	1680	760	900

	A	B	C	D	E
K5191	1800	800	1684	660	900
K5192	1800	900	1690	760	900
K2554	1800	1000	1680	760	900



K818701



K2552YK



K519101



K5191YK

Descripción

- Acrílico
- Tipos de instalación:
 - Encastrado
 - Sobre el suelo
 - Levantado con Styropor para crear una especie soporte
- 4 cm de espesor
- **Importante:** Los platos de ducha con acabado IdealGrip no se recomiendan en instalaciones no residenciales (hoteles, hospitales) dada su alta frecuencia de limpieza con productos industriales altamente concentrados.
- Lado accesible con proyección interna y externa de 2 cm máximo en la entrada. Conforme con el reglamento de accesibilidad (ley del 11/02/2005)

ULTRAFLAT ANGULAR



K240301



K240401

Descripción

- Acrílico
- Tipos de instalación:
 - Encastrado
 - Sobre el suelo
 - Levantado con Styropor para crear una especie soporte
- 4 cm de espesor
- **Importante:** Los platos de ducha con acabado IdealGrip no se recomiendan en instalaciones no residenciales (hoteles, hospitales) dada su alta frecuencia de limpieza con productos industriales altamente concentrados.
- Lado accesible con proyección interna y externa de 2 cm máximo en la entrada. Conforme con el reglamento de accesibilidad (ley del 11/02/2005)

Acabado: Blanco Brillo	Ref.	€/Ud.	Stock	Cant.
90 x 70 Izq	K240301	156		6
90 x 70 Dch	K240201	156		6
95 x 75 Izq	K240501	163		6
95 x 70 Dch	K240401	163		6
100 x 80 Izq	K240701	215		6
100 x 80 Dch	K240601	215		6
120 x 80 Izq	K240901	245		6
120 x 80 Dch	K240801	245		6

* Válvula desagüe no incluida

Acabado: Blanco con tratamiento antideslizante	Ref.	€/Ud.	Stock	Cant.
90 x 70 Izq	K2403YK	216		6
90 x 70 Dch	K2402YK	216		6
95 x 75 Izq	K2405YK	222		6
95 x 70 Dch	K2404YK	222		6
100 x 80 Izq	K2407YK	275		6
100 x 80 Dch	K2406YK	275		6
120 x 80 Izq	K2409YK	303		6
120 x 80 Dch	K2408YK	303		6

* Válvula desagüe no incluida

i **IMPORTANTE:** Plazo aproximado entrega de 4 semanas. No se recomienda su instalación en instalaciones no residenciales (hoteles, hospitales) dada su alta frecuencia de limpieza con productos industriales altamente concentrados.

Válvulas desagüe:	Ref.	€/Ud.	Stock	Cant.
Normal Ø 90mm	J3417AA	26	<input checked="" type="checkbox"/>	6
Plana Ø 90mm	T8520AA	41		6

Características técnicas

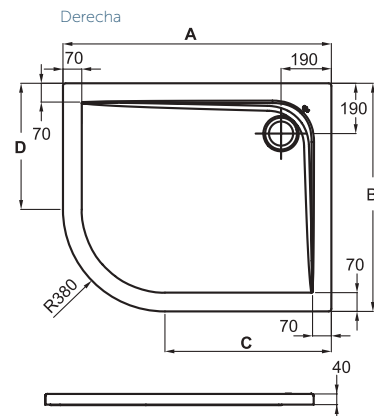
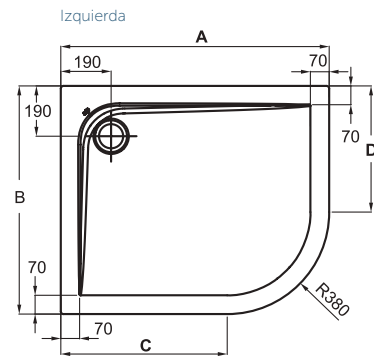

	A	B	C	D
K2402	900	700	520	320
K2403	900	700	520	320
K2404	950	750	570	370
K2405	950	750	570	370
K2406	1000	800	620	420
K2407	1000	800	620	420
K2408	1200	800	820	420
K2409	1200	800	820	420

IDEAL STANDARD

BAÑERAS

WELLNESS

ELEGANTES Y SOFISTICADAS

La comodidad para darte todas las facilidades en tu "momento baño". El diseño más exclusivo para que sea aún más especial.



BAÑERAS

DEA

Acabados de líneas sensuales y femeninas
para un diseño de belleza imperturbable.



WELLNESS



WELLNESS

BAÑERAS

HOTLINE

Diseño de formas rectas pensado para proporcionar el máximo confort a través de cada sencillo detalle.



WELLNESS



Grifería no comercializada en Ideal Standard Iberia



INFORMACIÓN TÉCNICA

BAÑERAS

Suntuosas, de líneas elegantes e indulgentes, ofrecen una experiencia para todos los sentidos. Sumérgete en la tentación.

BAÑERAS



BAÑERA EXENTA
DEA



BAÑERA DE ENCASTRAR
HOTLINE

BAÑERA EXENTA



Descripción

- Acrílico, suave al tacto
- Cubre pileta desagüe en material acrílico con forma trapezoidal
- Válvula desagüe incluida

Acabado: Blanco brillo	Ref.	€/Ud.	Stock	Cant.
NOVEDAD Dea bañera exenta 170 x 75	E306601	1.850		5
Dea bañera exenta 180 x 80	E306701	2.000		5
Dea bañera exenta 190 x 90	E306801	2.250		5
Repuestos	Ref.	€/Ud.	Stock	Cant.
Válvula descarga bañera	LV23567	120		N/A
Cubre pileta trapezoidal	LV238AA	78		N/A



IMPORTANTE: No es apta para instalación de hidromasaje

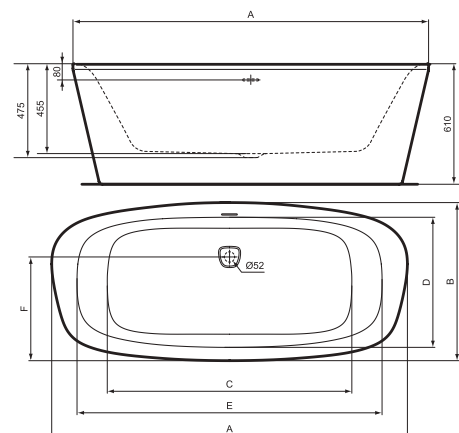

	A	B	C	D	E	F
E306601	1700	750	1115	610	1445	475
E306701	1800	800	1215	660	1545	525
E306801	1900	900	1315	760	1645	625

MELANGE MEZCLADOR BAÑO-DUCHA



Acabado: Cromo Brillo	Ref.	€/Ud.	Stock	Cant.
Mezclador exterior baño/ducha	A6120AA	1.250		5
* Pedir cuerpo interno A6133NU				
Acabado: Neutro	Ref.	€/Ud.	Stock	Cant.
Cuerpo interno A6133NU	A6133NU	455		5

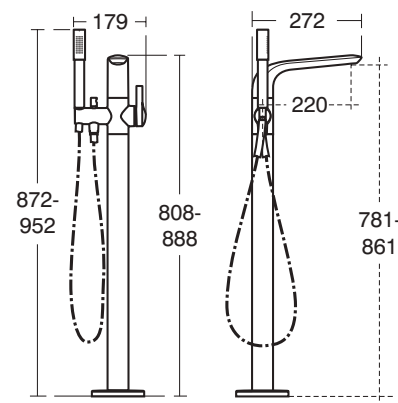

Descripción

- Cartucho cerámico multiport de 40mm con limitador de temperatura y desviador integrado en el interior del cuerpo
- Aireador regulable M24 5 L/min
- Equipado con accesorios: Duchon, extraíble con difusores de silicona anticálcicos, tubo Idealflex 1250mm
- **Es necesario utilizar el cuerpo A6133NU (se vende por separado)**

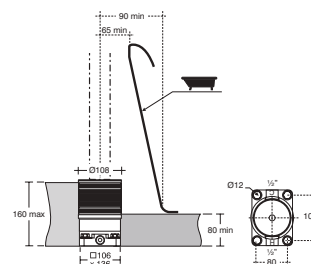

Cuerpo interno A6133NU

HOTLINE

BAÑERAS DE ENCASTRAR

Acabado: Blanco brillo	Ref.	€/Ud.	Stock	Cant.
Bañera Hotline 160x70	K274501	195		10
Bañera Hotline 170x75	K274601	209		10
Bañera Hotline 170x80	K274701	250		10
Bañera Hotline 180x80	K274801	275		10

Acabado: Blanco brillo	Ref.	€/Ud.	Stock	Cant.
Bañera Hotline Duo 170x75	K274901	209		10
Bañera Hotline Duo 180x80	K275001	275		10

Opcional	Ref.	€/Ud.	Stock	Cant.
Juego patas bañeras hotline	C895100	35		10
Válvula desagüe bañeras	T603767	50		10

Paneles opcionales:

Acabado: Blanco Brillo	Ref.	€/Ud.	Stock	Cant.
Panel lateral acrílico 70*	K229401	135		10
Panel lateral acrílico 75*	K229501	135		10
Panel lateral acrílico 80*	K229601	135		10
Panel frontal acrílico 160*	K229901	195		10
Panel frontal acrílico 170*	K230001	205		10
Panel frontal acrílico 180*	K230101	215		10

* Es necesario utilizar el juego de patas para la instalación



Descripción

- Acabado blanco brillo
- Acrílico, suave al tacto
- Autoportantes ya que vienen suministradas con estructura

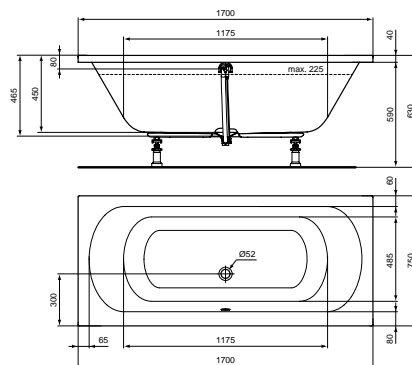
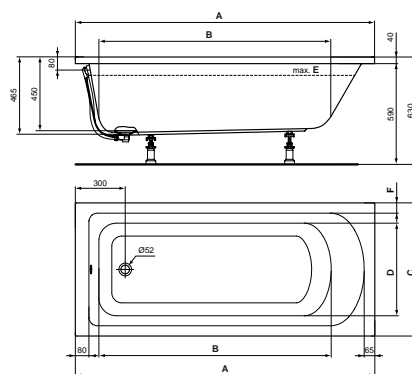

	A	B	C	D	E	F
K274501	1600	1195	700	460	210	60
K274601	1700	1295	750	505	250	60
K274701	1700	1295	800	585	285	55
K274801	1800	1396	800	555	295	60
K274901	1700	1175	750	485	225	40
K275001	1800	1275	800	535	265	60

IDEAL STANDARD

COLECTIVIDADES

Accesorios prácticos, de diseño y calidad que dotan a los ambientes de tránsito masivo de la seguridad y confort que requieren.

ESCUELAS	366
DISCAPACIDAD	372
PIEZAS ESPECIALES Y VERTEDEROS	376
URINARIOS	380
ACCESORIOS	384





INFORMACIÓN TÉCNICA

ESCUELAS

Inodoros sin brida para una mejor limpieza y desinfección

Primera etapa de 3 a 7 años

El inicio de la primera etapa es clave, los niños van al baño solos por primera vez. Contour 21 con sus colores brillantes y el divertido diseño hace que este cambio sea más fácil.



Segunda etapa de 7 a 11 años

A medida que los niños entran en la segunda etapa los inodoros son más altos. La gama es suficientemente flexible como para ofrecer un diseño más adecuado a su edad en la escuela.



LAVABOS CONTOUR 21

LAVAMANOS 40 CONTOUR 21



Acabado: Blanco Brillo	Ref.	€/Ud.	Stock	Cant.
Lavabo 40 sin rebosadero*	S263901	50		10
Lavabo 40 con rebosadero*	S263701	50		10

*Se suministra sin juego de fijaciones

Opcional	Ref.	€/Ud.	Stock	Cant.
Juego fijación	J117767	5	<input checked="" type="checkbox"/>	10
Sifón de diseño	R6625AA	68	<input checked="" type="checkbox"/>	10

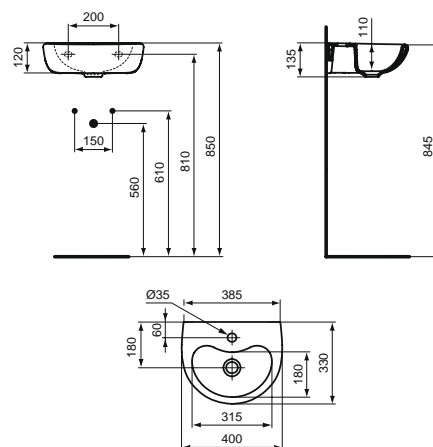

Descripción

- Cerámica
- Agujero para grifo
- **Juego de fijación no incluido**

LAVABO 60 CONTOUR 21



Acabado: Blanco Brillo	Ref.	€/Ud.	Stock	Cant.
Lavabo 60 con rebosadero*	S266401	65		10

*Se suministra sin juego de fijaciones

Opcional	Ref.	€/Ud.	Stock	Cant.
Juego fijación	J117767	5	<input checked="" type="checkbox"/>	10
Sifón de diseño	R6625AA	68	<input checked="" type="checkbox"/>	10

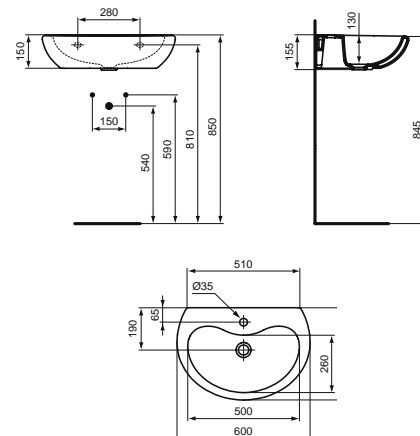

Descripción

- Cerámica
- Agujero para grifo
- **Juego de fijación no incluido**



Dispensadores de jabón no comercializados por Ideal Standard Iberia

INODOROS CONTOUR 21



CONTOUR 21 A PARED

Inodoro Altura 305 mm

Acabado: Blanco Brillo	Ref.	€/Ud.	Stock	Cant.
Inodoro a pared Sin Brida	S312301	140		10

Características técnicas



Opcional para hacer salida vertical, solicitar el código:

	Ref.	€/Ud.	Stock	Cant.
Codo	WW965742	15	<input checked="" type="checkbox"/>	6

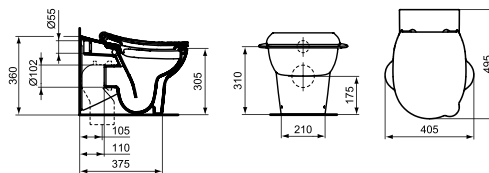

TAPAS Y ASIENTOS CONTOUR 21



Acabado: Blanco Brillo	Ref.	€/Ud.	Stock	Cant.
Tapa y asiento blanco con cierre normal	S453301	55		10
Tapa y asiento azul con cierre normal	S453336	55		10
Tapa y asiento amarillo con cierre normal	S453379	55		10
Tapa y asiento rojo con cierre normal	S4533GQ	55		10

Características técnicas

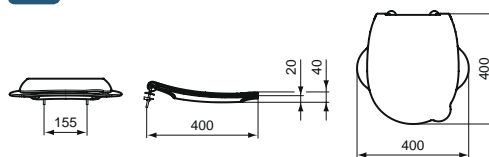

ASIENTOS CONTOUR 21



Acabado: Blanco Brillo	Ref.	€/Ud.	Stock	Cant.
Asiento blanco con cierre normal	S454201	50		10
Asiento azul con cierre normal	S454236	50		10
Asiento amarillo con cierre normal	S454279	50		10
Asiento rojo con cierre normal	S4542GQ	50		10

Características técnicas

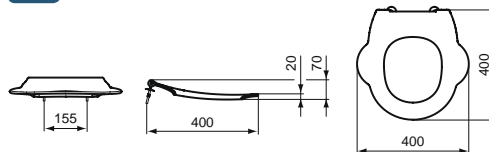

INODOROS CONTOUR 21



CONTOUR 21 A PARED

Inodoro Altura 355 mm

Acabado: Blanco Brillo	Ref.	€/Ud.	Stock	Cant.
Inodoro a pared Sin Brida	S312601	145		10

Características técnicas



Opcional para hacer salida vertical, solicitar el código:

	Ref.	€/Ud.	Stock	Cant.
Codo	WW965742	15	<input checked="" type="checkbox"/>	6

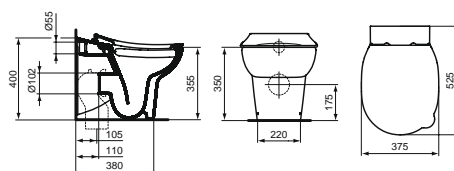

TAPAS Y ASIENTOS CONTOUR 21



Acabado: Blanco Brillo	Ref.	€/Ud.	Stock	Cant.
Tapa y asiento blanco con cierre normal	S453601	55		10
Tapa y asiento azul con cierre normal	S453636	55		10
Tapa y asiento amarillo con cierre normal	S453679	55		10
Tapa y asiento rojo con cierre normal	S4536GQ	55		10

Características técnicas

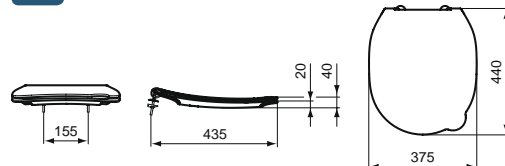

ASIENTOS CONTOUR 21



Acabado: Blanco Brillo	Ref.	€/Ud.	Stock	Cant.
Asiento blanco con cierre normal	S454501	50		10
Asiento azul con cierre normal	S454536	50		10
Asiento amarillo con cierre normal	S454579	50		10
Asiento rojo con cierre normal	S4545GQ	50		10

Características técnicas

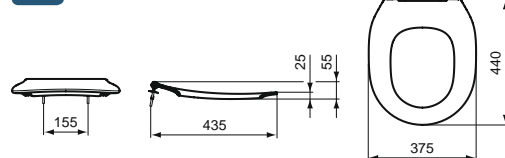

CONTOUR 21 SUSPENDIDO

Inodoro Altura 355 mm



Acabado: Blanco Brillo	Ref.	€/Ud.	Stock	Cant.
Inodoro suspendido Sin Brida	S312801	250		10

Características técnicas

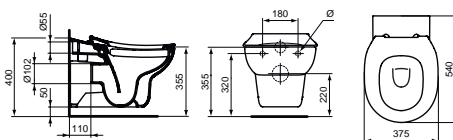

TAPAS Y ASIENTOS CONTOUR 21



Acabado: Blanco Brillo	Ref.	€/Ud.	Stock	Cant.
Tapa y asiento blanco con cierre normal	S453301	55		10
Tapa y asiento azul con cierre normal	S453336	55		10
Tapa y asiento amarillo con cierre normal	S453379	55		10
Tapa y asiento rojo con cierre normal	S4533GQ	55		10

Características técnicas

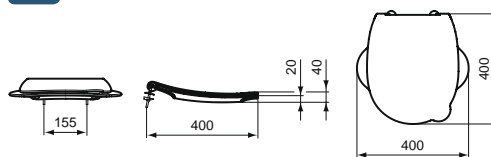

ASIENTOS CONTOUR 21



Acabado: Blanco Brillo	Ref.	€/Ud.	Stock	Cant.
Asiento blanco con cierre normal	S454201	50		10
Asiento azul con cierre normal	S454236	50		10
Asiento amarillo con cierre normal	S454279	50		10
Asiento rojo con cierre normal	S4542GQ	50		10

Características técnicas

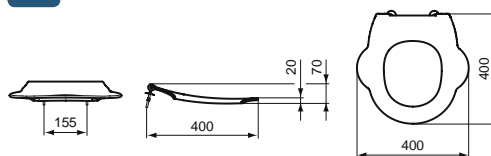



COLECTIVIDADES

INFORMACIÓN TÉCNICA

DISCAPACIDAD

Un día a día más seguro y confortable a través de nuestro diseño funcional y elegante

DISCAPACIDAD



LAVABOS



LAVAMANOS



INODORO
PROYECCIÓN 70



INODORO
ABIERTO ELEVADO

LAVABOS DISCAPACIDAD

LAVABOS



Descripción

- Lavabo sin pedestal
- Posibilidad de lavabo sin orificio para grifería
- Con acabado en porcelana vitrificada con rebosadero visto
- Borde curvo que garantiza una sujeción más segura, la parte frontal recta proporcionando una perfecta adherencia entre la persona y el lavabo
- **Juego de fijación no incluido**

Acabado: Blanco Brillo	Ref.	€/Ud.	Stock	Cant.
C21 lavabo 55 cm sin agujero para grifería*	S216401	70		10
C21 lavabo 55 cm con agujero para grifería*	S216501	70		10
C21 lavabo 60 cm sin agujero para grifería*	S216701	75		10
C21 lavabo 60 cm con agujero para grifería*	S216801	75		10

*Se suministra sin juego de fijaciones

Opcional	Ref.	€/Ud.	Stock	Cant.
Válvula desagüe libre y sifón	S8703AA	100		10
Juego fijación lavabos	J117767	5		10

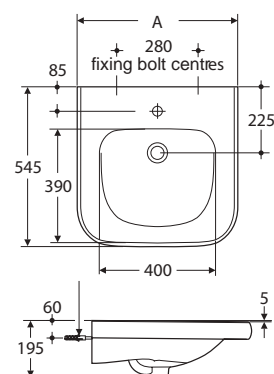

	A
S216401	550
S216501	550
S216701	600
S216801	600

LAVAMANOS



Descripción

- Lavabo sin pedestal
- Posibilidad de lavabo sin orificio para grifería
- Con acabado en porcelana vitrificada con rebosadero visto
- Borde curvo que garantiza una sujeción más segura, la parte frontal recta proporcionando una perfecta adherencia entre la persona y el lavabo
- **Juego de fijación no incluido**

Acabado: Blanco Brillo	Ref.	€/Ud.	Stock	Cant.
C21 lavamanos 37 con agujero para grifería sin rebosadero*	S212201	65		10

*Se suministra sin juego de fijaciones

Opcional	Ref.	€/Ud.	Stock	Cant.
Válvula desagüe libre y sifón	S8703AA	100		10
Colgadores lavamanos c21	S911067	10		10

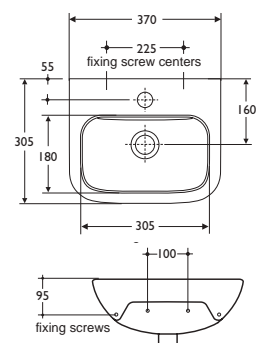

INODOROS DISCAPACIDAD



Descripción
· Profundidad de 70 cm

INODORO PROYECCIÓN 70 CM

Acabado: Blanco Brillo	Ref.	€/Ud.	Stock	Cant.
C21 inodoro suspendido Sin brida (Rimless)	S307701	175		10
Opcional	Ref.	€/Ud.	Stock	Cant.
C21 asiento blanco	S406601	45		10
C21 barra para cojin blanco	S6481AC	50		10
C21 cojín blanco	S688467	35		10

Características técnicas

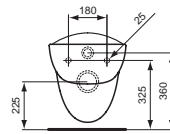
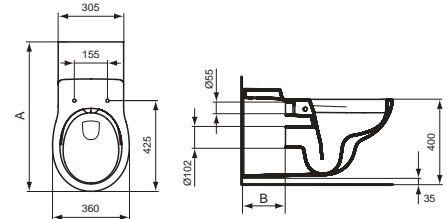

	A	B
S3077	700	195



NOVEDAD

INODORO ABIERTO ELEVADO 46CM

Acabado: Blanco Brillo	Ref.	€/Ud.	Stock	Cant.
C21 inodoro abierto*	S310601	425		10
Tanque 4,5/2,5L A/L	S310801	180		10
Asiento Gris	S4078LJ	60		10
Asiento y tapa blanco	S407901	75		10

Características técnicas

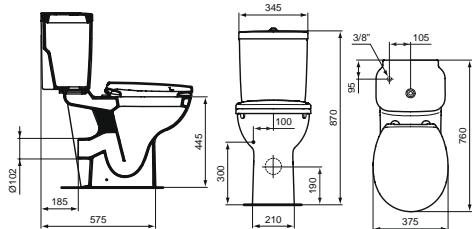

* Codo salida vertical no incluido

Opcional para hacer salida vertical, solicitar el código:

	Ref.	€/Ud.	Stock	Cant.
Codo	WW965742	20	<input checked="" type="checkbox"/>	6



INFORMACIÓN TÉCNICA

BARRAS Y PASAMANOS

La dedicación para satisfacer las necesidades de las personas más necesitadas. A pesar de las miradas escépticas, estos productos han sido elegidos especialmente por su robustez y aptitud para su uso. Desde el cuarto de baño más pequeño hasta la instalación pública más grande.

BARRAS



PASAMANOS



PASAMANOS ANGULAR



BARRA DE APOYO TRASERO



BARRA APOYO ABATIBLE



BARRA ANGULAR

BARRAS CONTOUR 21



PASAMANOS 30, 40, 50, 60

Acabado: Blanco Brillo	Ref.	€/Ud.	Stock	Cant.
Pasamanos 30 cm	S6450AC	19		10
Pasamanos 40 cm	S6452AC	20		10
Pasamanos 50 cm	S6453AC	22		10
Pasamanos 60 cm	S6454AC	25		10

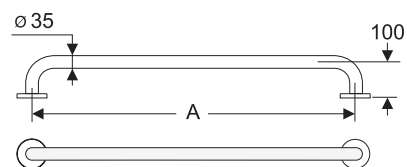

	A
S6450AC	30
S6452AC	45
S6453AC	50
S6454AC	60



PASAMANOS 70, 75, 80, 90

Acabado: Blanco Brillo	Ref.	€/Ud.	Stock	Cant.
Pasamanos 70 cm	S6455AC	26		10
Pasamanos 80 cm	S6457AC	28		10
Pasamanos 90 cm	S6458AC	29		10

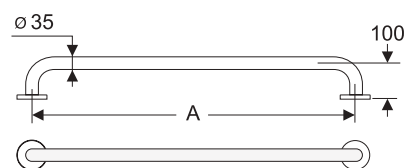

	A
S6455AC	70
S6456AC	75
S6457AC	80
S6458AC	90



PASAMANOS 100, 110, 120, 175

Acabado: Blanco Brillo	Ref.	€/Ud.	Stock	Cant.
Pasamanos 100 cm	S6459AC	30		10
Pasamanos 110 cm	S6460AC	40		10
Pasamanos 120 cm	S6461AC	45		10
Pasamanos 175 cm	S6462AC	55		10

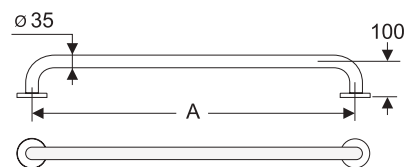

	A
S6459AC	100
S6460AC	110
S6461AC	120
S6462AC	175



PASAMANOS ANGULAR 90x40cm

Acabado: Blanco Brillo	Ref.	€/Ud.	Stock	Cant.
Pasamanos angular derecha	S6473AC	55		10
Pasamanos angular izquierda	S6474AC	55		10

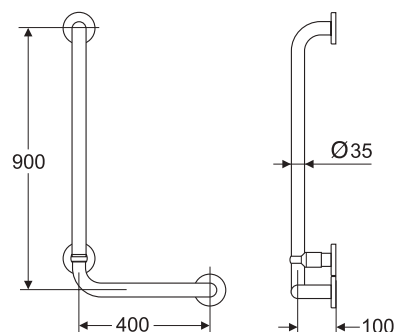

BARRA APOYO TRASERO

Acabado: Blanco Brillo	Ref.	€/Ud.	Stock	Cant.
Barra apoyo trasero 40x17 cm	S6481AC	20		10

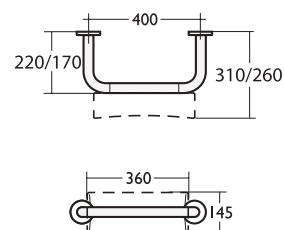

BARRA APOYO ABATIBLE

Acabado: Blanco Brillo	Ref.	€/Ud.	Stock	Cant.
Barra apoyo abatible 78 cm	S6360AC	85		10

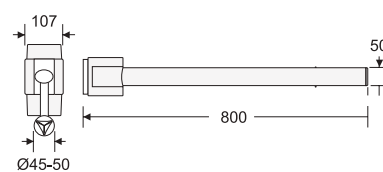

Opcional extensión barra apoyo

Acabado: Blanco	Ref.	€/Ud.	Stock	Cant.
Extensión	S6363AC	50		10

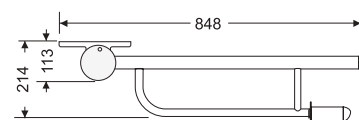
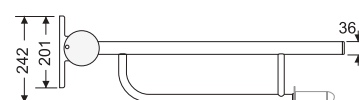

BARRA ANGULAR 45

Acabado: Blanco Brillo	Ref.	€/Ud.	Stock	Cant.
Barra angular 45x45 cm	S6472AC	65		10

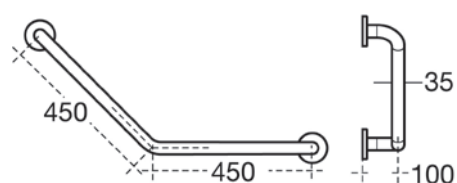



INFORMACIÓN TÉCNICA

URINARIOS Y VERTEDEROS

Su forma ergonómica y redondeada hacen de sus diseños los más versátiles del mercado. Estilo y elegancia perfectamente pensado para los espacios públicos.

COLECTIVIDADES URINARIOS



Descripción

- Para salida horizontal o vertical (Orificio en la parte inferior)
- Juego de fijación incluido **TT029931**
- Sin embalaje
- Peso 15,5 kg

CONNECT ALIMENTACIÓN POSTERIOR

Acabado: Blanco Brillo	Ref.	€/Ud.	Stock	Cant.
Urinario alimentación posterior	E567101	179		10
Recomendado	Ref.	€/Ud.	Stock	Cant.
Kit de conexión urinario	K710667	10		10
Opcional	Ref.	€/Ud.	Stock	Cant.
Sifón salida horizontal	K822367	35		10
Sifón salida vertical	K751501	35		10
Separador cerámico	S612001	105		10

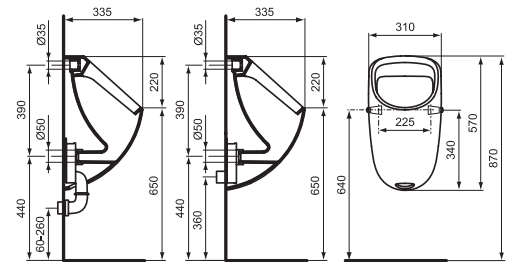

CONNECT ALIMENTACIÓN SUPERIOR

Acabado: Blanco Brillo	Ref.	€/Ud.	Stock	Cant.
Urinario alimentación superior	E567201	179		10
Recomendado	Ref.	€/Ud.	Stock	Cant.
Kit de conexión urinario	K710667	10		10
Opcional	Ref.	€/Ud.	Stock	Cant.
Sifón salida horizontal	K822367	35		10
Sifón salida vertical	K751501	35		10
Separador cerámico	S612001	105		10

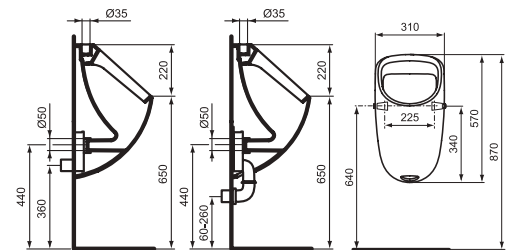

Descripción

- Para salida horizontal o vertical (Orificio en la parte inferior)
- Juego de fijación incluido **TT029931**
- Sin embalaje
- Peso 12,5 kg

EUROVIT ALIMENTACIÓN POSTERIOR

Acabado: Blanco Brillo	Ref.	€/Ud.	Stock	Cant.
Urinario alimentación posterior	K553801	155		10
Recomendado	Ref.	€/Ud.	Stock	Cant.
Kit de conexión urinario	K710667	10		10
Opcional	Ref.	€/Ud.	Stock	Cant.
Sifón salida horizontal	K822367	35		10
Sifón salida vertical	K751501	35		10
Separador cerámico	S612001	105		10

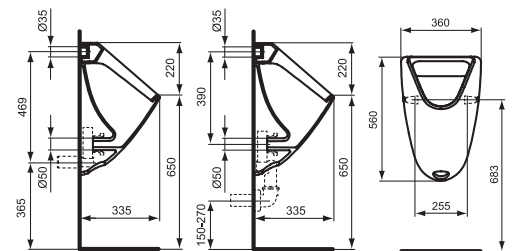

EUROVIT ALIMENTACIÓN SUPERIOR

Acabado: Blanco Brillo	Ref.	€/Ud.	Stock	Cant.
Urinario alimentación superior	K553901	155		10
Recomendado	Ref.	€/Ud.	Stock	Cant.
Kit de conexión urinario	K710667	10		10
Opcional	Ref.	€/Ud.	Stock	Cant.
Sifón salida horizontal	K822367	35		10
Sifón salida vertical	K751501	35		10
Separador cerámico	S612001	105		10

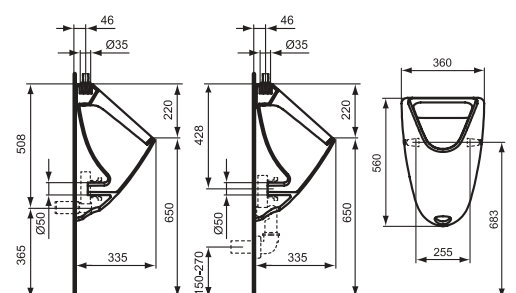

COLECTIVIDADES ACCESORIOS



SEPARADOR CERÁMICO

Acabado: Blanco Brillo	Ref.	€/Ud.	Stock	Cant.
Separador cerámico	S612001	105		10

Descripción

- Cerámica
- Incluido sistema de fijación oculta
- Peso 8,5 kg

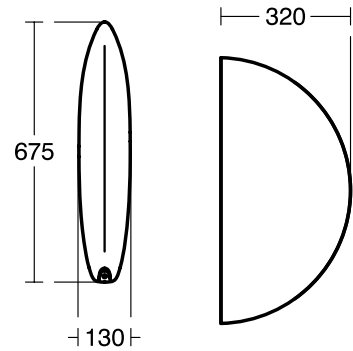

VERTEDEROS



VERTEDERO SUSPENDIDO CON REJILLA

Acabado: Blanco Brillo	Ref.	€/Ud.	Stock	Cant.
Vertedero con rejilla	S593901	195		10
Opcional	Ref.	€/Ud.	Stock	Cant.
Sifón	J196067	15		10
Estructura para soporte	D5705AC	30		10
Juego de patas	S9233MY	40		10

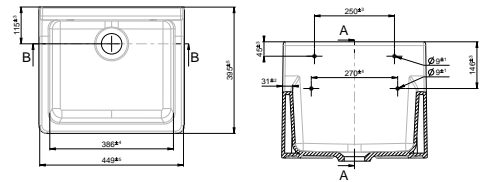

VERTEDERO A SUELO BRENTA



Acabado: Blanco Brillo	Ref.	€/Ud.	Stock	Cant.
Vertedero Brenta salida horizontal	J377201	200		10
Vertedero Brenta salida vertical	J377301	200		10
Recomendado	Ref.	€/Ud.	Stock	Cant.
Juego fijación vertedero	TT029931	5		10
Opcional	Ref.	€/Ud.	Stock	Cant.
Rejilla para vertedero Brenta	J3494AA	70		10

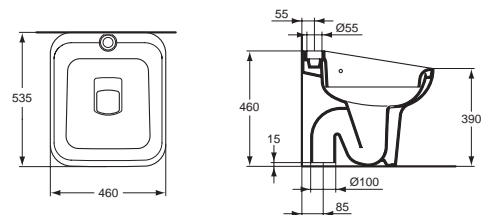
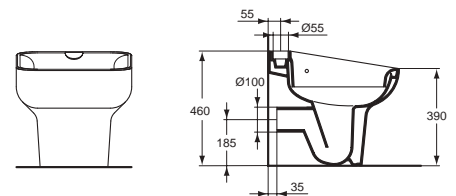



INFORMACIÓN TÉCNICA

ACCESORIOS

EL COMPLEMENTO PERFECTO PARA TI

Combina como más te guste, con sus formas y tamaños podrás escoger el que más se adapte a ti y a tu cuarto de baño.

IDEAL STANDARD ACCESORIOS



TOALLERO ANILLA

Acabado: Cromo Brillo	Ref.	€/Ud.	Stock	Cant.
Toallero anilla	A9130AA	30		10

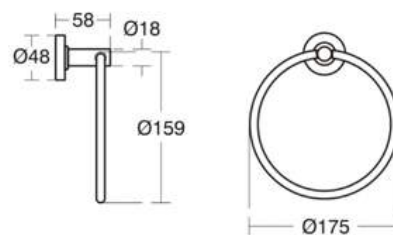

Descripción

· Toallero anilla para instalación a pared



TOALLERO

Acabado: Cromo Brillo	Ref.	€/Ud.	Stock	Cant.
Toallero 60 cm	A9118AA	30		10
Toallero 45 cm	A9117AA	27		10

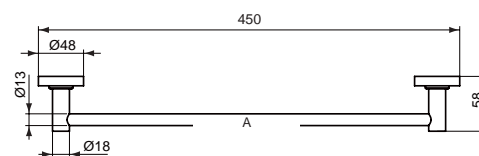

Descripción

· Toallero para instalación a pared

	A
A9118AA	600
A9117AA	450



TOALLERO DOBLE

Acabado: Cromo Brillo	Ref.	€/Ud.	Stock	Cant.
Toallero doble	A9131AA	51		10

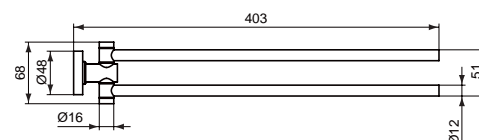

Descripción

· Toallero doble para instalación a pared



PERCHA

Acabado: Cromo Brillo	Ref.	€/Ud.	Stock	Cant.
Percha	A9115AA	10		10

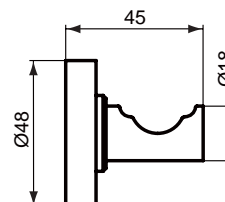

Descripción

· Percha para instalación a pared



PERCHA DOBLE

Acabado: Cromo Brillo	Ref.	€/Ud.	Stock	Cant.
Percha doble	A9116AA	14		10

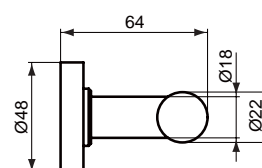

Descripción

· Percha doble para instalación a pared



PORTAVASOS CRISTAL TRANSLÚCIDO

Acabado: Cromo Brillo	Ref.	€/Ud.	Stock	Cant.
Portavasos translúcido	A9120AA	26		10

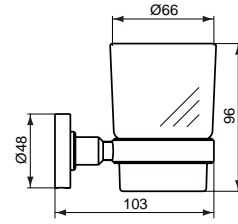

Descripción

· Portavasos vaso cristal translúcido para instalación a pared



PORTAVASOS CRISTAL TRANSPARENTE

Acabado: Cromo Brillo	Ref.	€/Ud.	Stock	Cant.
Portavasos transparente	A9121AA	26		10

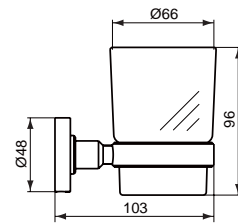

Descripción

· Portavasos vaso cristal transparente para instalación a pared



JABONERA CRISTAL TRANSLÚCIDO

Acabado: Cromo Brillo	Ref.	€/Ud.	Stock	Cant.
Jabonera translúcido	A9122AA	26		10

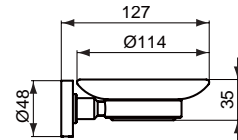

Descripción

· Jabonera en cristal translúcido para instalación a pared



JABONERA CRISTAL TRANSPARENTE

Acabado: Cromo Brillo	Ref.	€/Ud.	Stock	Cant.
Jabonera transparente	A9123AA	26		10

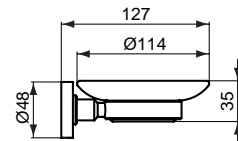

Descripción

· Jabonera en cristal transparente para instalación a pared



JABONERA ANTIVANDÁLICA

Acabado: Cromo Brillo	Ref.	€/Ud.	Stock	Cant.
Jabonera antivandálica	A9129AA	29		10

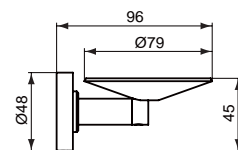

Descripción

· Jabonera antivandálica para instalación a pared

IDEAL STANDARD ACCESORIOS

REPISA 60 CM CRISTAL TRANSLÚCIDO



Acabado: Cromo Brillo	Ref.	€/Ud.	Stock	Cant.
Repisa 60 cm translúcido	A9124AA	47		10

Descripción
· Repisa 60 cm en cristal translúcido para instalación a pared

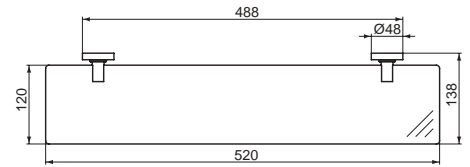

REPISA 60 CM CRISTAL TRANSPARENTE



Acabado: Cromo Brillo	Ref.	€/Ud.	Stock	Cant.
Repisa 60 cm transparente	A9125AA	47		10

Descripción
· Repisa 60 cm en cristal transparente para instalación a pared

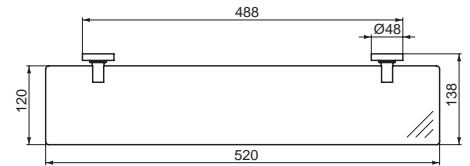

PAPELERA 3L



Acabado: Cromo Brillo	Ref.	€/Ud.	Stock	Cant.
Papelera 3L	A9104MY	34		10

Descripción
· Papelera metálica

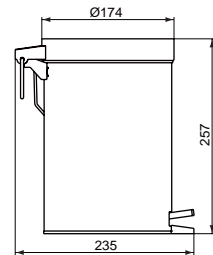

ESPEJO 3X AUMENTOS A PARED



Acabado: Cromo Brillo	Ref.	€/Ud.	Stock	Cant.
Espejo 3X aumentos	A9111AA	91		10

Descripción
· Espejo 3X aumentos para instalación a pared

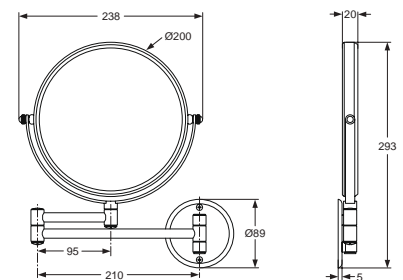

JABONERA REJILLA



Acabado: Cromo Brillo	Ref.	€/Ud.	Stock	Cant.
Jabonera rejilla	A9112AA	26		10

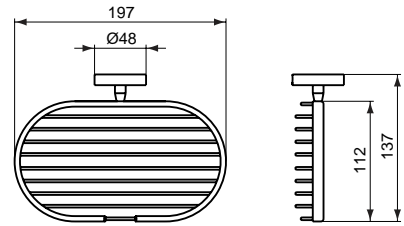

Descripción

· Jabonera rejilla para instalación a pared

CONTENEDOR REJILLA EN ÁNGULO



Acabado: Cromo Brillo	Ref.	€/Ud.	Stock	Cant.
Contenedor rejilla	A9105AA	28		10

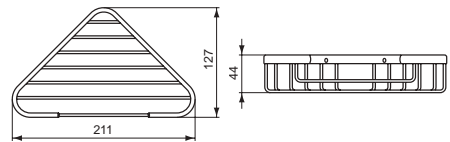

Descripción

· Portajabón rejilla en ángulo para instalación a pared

PASAMANOS CON JABONERA



Acabado: Cromo Brillo	Ref.	€/Ud.	Stock	Cant.
Pasamanos con jabonera	A9114AA	69		10

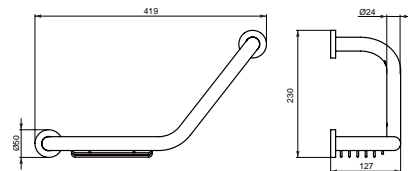

Descripción

· Pasamanos para ducha con jabonera para instalación a pared

PASAMANOS



Acabado: Cromo Brillo	Ref.	€/Ud.	Stock	Cant.
Pasamanos 30 cm	A9126AA	31		10

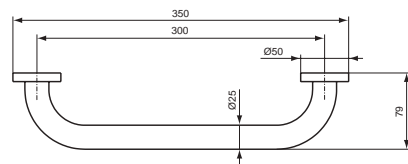

Descripción

· Pasamanos 30 cm para ducha para instalación a pared

IDEAL STANDARD ACCESORIOS

PORTATOALLAS



Descripción
· Portatoallas para instalación a pared

Acabado: Cromo Brillo	Ref.	€/Ud.	Stock	Cant.
Portatoallas	A9106AA	90		10

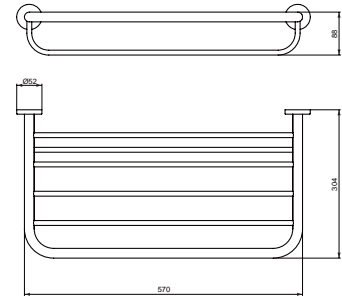

PORTA-KLEENEX



Descripción
· Porta Kleenex para instalación a pared

Acabado: Cromo Brillo	Ref.	€/Ud.	Stock	Cant.
Porta-Kleenex	A9133MY	42		10

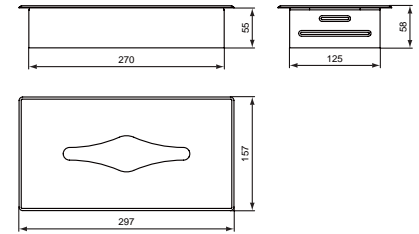

DOSIFICADOR A PARED 500ml



Descripción
· Dosificador de 500ml para instalación a pared

Acabado: Cromo Brillo	Ref.	€/Ud.	Stock	Cant.
Disifcador 500ml	A9109MY	47		10

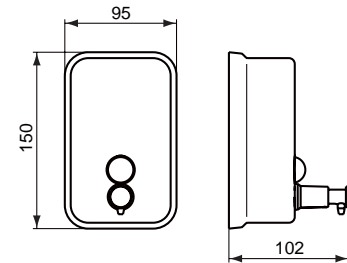

DOSIFICADORES A PARED



Descripción
· Dispensadores de 800ml y 1L para instalación a pared

Acabado: Cromo Brillo	Ref.	€/Ud.	Stock	Cant.
Dispensador 800ml	A9103MY	52		10
Dispensador 1L	A9110MY	57		10

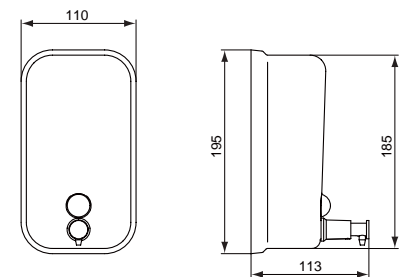



PORTARROLLO CON TAPA

Acabado: Cromo Brillo	Ref.	€/Ud.	Stock	Cant.
Portarrollo con tapa	A9127AA	31		10

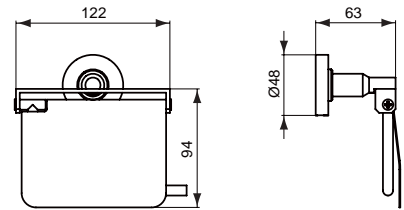

Descripción

· Portarrollo con tapa para instalación a pared



PORTARROLLO VERTICAL

Acabado: Cromo Brillo	Ref.	€/Ud.	Stock	Cant.
Portarrollo sin tapa	A9132AA	26		10

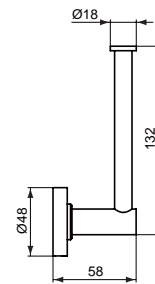

Descripción

· Portarrollo de cortesia para instalación a pared



ESCOBILLERO PARED

Acabado: Cromo Brillo	Ref.	€/Ud.	Stock	Cant.
Escobillero pared	A9128MY	58		10

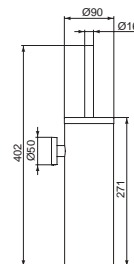

Descripción

· Escobillero para instalación a pared



ESCOBILLERO SUELO

Acabado: Cromo Brillo	Ref.	€/Ud.	Stock	Cant.
Escobillero suelo	A9108MY	58		10

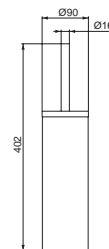

Descripción

· Escobillero a suelo



ESCOBILLERO A PARED CRISTAL TRANSLÚCIDO

Acabado: Cromo Brillo	Ref.	€/Ud.	Stock	Cant.
Escobillero cristal	A9119AA	37		10

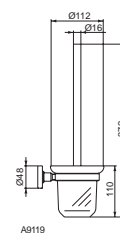

Descripción

· Escobillero en cristal translúcido para instalación a pared

IDEAL STANDARD

REPUESTOS

La solución perfecta para cada detalle.





REPUESTOS GRIFERÍA

SERIE TONIC II



Acabado: Neutro	Ref.	Dónde se usa	€/Ud.
Aireadores	F960876AA	A6326AA · A6327AA · A6328AA · A6329AA A6330AA A6331AA · A6332AA · A6333AA A6334AA · A6335AA	15
	B964902AA	A6336AA	5
	A961132AA	A6338AA	10



Acabado: Neutro	Ref.	Dónde se usa	€/Ud.
Rótula bidé	A960019AA	A6336AA	19



Acabado: Neutro	Ref.	Dónde se usa	€/Ud.
Manetas	A860890AA	A6330AA · A6331AA · A6326AA · A6327AA A6328AA · A6329AA · A6336AA	27
	A860894AA	A6332AA · A6333AA	15
	A860896AA	A6334AA · A6335AA · A6343AA · A6342AA	35
	A860925AA	A6338AA · A6337AA	35



Acabado: Neutro	Ref.	Dónde se usa	€/Ud.
Cartuchos monomando	F960855NU	A6326AA · A6327AA · A6330AA · A6331AA A6332AA · A6333AA · A6336AA	35
	A960500NU	A6328AA · A6329AA · A6334AA · A6335AA A6343AA · A6342AA	19
	A962716NU	A6337AA · A6338AA	43



Acabado: Neutro	Ref.	Dónde se usa	€/Ud.
Kit Easy-Fix	A964520NU	A6326AA · A6327AA · A6328AA · A6329AA A6330AA · A6331AA · A6332AA · A6333AA	5



Acabado: Neutro	Ref.	Dónde se usa	€/Ud.
Válvula automática	A961230AA	A6326AA · A6328AA · A6330AA · A6332AA	26
	A962991AA	A6336AA	26

SERIE EDGE



Acabado: Neutro	Ref.	Dónde se usa	€/Ud.
Aireadores	A960537AA	A7121AA	5
	A963369AA	A7118AA	15
	B960754AA	A7116AA	5
	B961383AA	A7265AA · A7266AA · A7267AA · A7268AA · A7101AA A7102AA · A7103AA · A7106AA · A7107AA · A7108AA A7111AA · A7110AA · A7112AA · A7113AA · A7114AA A7115AA	5



Acabado: Neutro	Ref.	Dónde se usa	€/Ud.
Rótula bidé	A960019AA	A7118AA	19



Acabado: Neutro	Ref.	Dónde se usa	€/Ud.
Manetas	A861020AA	A7126AA · A7127AA	35
	A861294AA	A7265AA · A7266AA · A7101AA · A7103AA · A7106AA A7108AA · A7112AA · A7114AA · A7118AA	35
	A861308AA	A7267AA · A7268AA · A7102AA · A7107AA A7113AA · A7115AA	35
	A861309AA	A7111AA · A7110AA	35
	A861311AA	A7116AA	35
	B961531AA	A7120AA · A7121AA	35



Acabado: Neutro	Ref.	Dónde se usa	€/Ud.
Cartuchos monomando	A861156NU	A7120AA · A7121AA	43
	A861226NU	A7265AA · A7266AA · A7267AA · A7268AA · A7101AA A7102AA · A7103AA · A7106AA · A7107AA · A7108AA A7112AA · A7113AA · A7114AA · A7115AA · A7118AA	30
	A960500NU	A7126AA · A7127AA	19
	F960855NU	A7111AA · A7110AA	35



Acabado: Neutro	Ref.	Dónde se usa	€/Ud.
Kit Easy-Fix	A964520NU	A7265AA · A7266AA · A7268AA · A7101AA · A7102AA A7103AA · A7106AA · A7107AA · A7108AA · A7111AA A7110AA · A7112AA · A7113AA · A7114AA · A7115AA A7118AA	5



Acabado: Neutro	Ref.	Dónde se usa	€/Ud.
Válvula automática	A961230AA	A7111AA · A7110AA	26
	B960853AA	A7265AA · A7267AA · A7102AA · A7106AA A7107AA · A7112AA · A7113AA · A7118AA	20

REPUESTOS GRIFERÍA

SERIE CONNECT AIR



Acabado: Neutro	Ref.	Dónde se usa	€/Ud.
Aireadores	B961383AA	A7007AA · A7008AA · A7010AA · A7011AA A7012AA A7013AA · A7014AA · A7015AA A7016AA · A7017AA A7018AA · A7019AA A7020AA · A7023AA · A7025AA · A7027AA	5
	A861069NU	A7009AA · A7029AA	15
	A963181NU	A7033AA · A7032AA	10
	A963369AA	A7030AA	15



Acabado: Neutro	Ref.	Dónde se usa	€/Ud.
Rótula bidé	A960019AA	A7030AA	19



Acabado: Neutro	Ref.	Dónde se usa	€/Ud.
Manetas	A861222AA	A7030AA · A7012AA · A7015AA	30
	A861228AA	A7013AA · A7016AA	30
	A861233AA	A7020AA · A7023AA · A7025AA A7027AA · A7029AA · A7009AA	30
	A861230AA	A7033AA · A7032AA	30
	A861236AA	A7037AA · A7036AA	30



Acabado: Neutro	Ref.	Dónde se usa	€/Ud.
Cartuchos monomando	A861226NU	A7030AA · A7012AA · A7015AA · A7013AA · A7016AA	30
	F960855NU	A7020AA · A7023AA	35
	A861156NU	A7033AA · A7032AA	43
	A960500NU	A7037AA · A7036AA	19



Acabado: Neutro	Ref.	Dónde se usa	€/Ud.
Kit Easy-Fix	A964520NU	A7030AA · A7012AA · A7015AA · A7013AA · A7016AA A7020AA · A7023AA · A7025AA · A7027AA	5



Acabado: Neutro	Ref.	Dónde se usa	€/Ud.
Válvula automática	B960853AA	A7012AA · A7013AA · A7025AA · A7030AA	20
	A962991AA	A7020AA	26

SERIE TESI-CERAMIX



Acabado: Neutro	Ref.	Dónde se usa	€/Ud.
Aireadores	A860050AA	A6542AA · A6559AA · A6553AA · A6545AA	10
	B960754AA	A6543AA · A6560AA · A6573AA · A6575AA	5
	F960876AA	A6578AA	15
	A963369AA	A6545AA	15
	A963181NU	A6583AA · A6581AA	10



Acabado: Neutro	Ref.	Dónde se usa	€/Ud.
Rótula bidé	A960019AA	A6545AA	19



Acabado: Neutro	Ref.	Dónde se usa	€/Ud.
Manetas	A861018AA	A6542AA · A6559AA · A6553AA · A6545AA	29
	A861023AA	A6543AA · A6560AA · A6573AA · A6575AA	35
	A861020AA	A6578AA · A6549AA · A6548AA	35
	A861019AA	A6583AA · A6581AA	35



Acabado: Neutro	Ref.	Dónde se usa	€/Ud.
Cartuchos monomando	F960855NU	A6545AA	35
	A960500NU	A6578AA · A6549AA · A6548AA	19
	B960775NU	A6583AA · A6581AA	15



Acabado: Neutro	Ref.	Dónde se usa	€/Ud.
Kit Easy-Fix	A964520NU	A6545AA · A6542AA · A6559AA · A6543AA A6560AA · A6563AA · A6564AA · A6565AA A6571AA · A6573AA · A6575AA	5



Acabado: Neutro	Ref.	Dónde se usa	€/Ud.
Válvula automática	A962991AA	A6545AA · A6542AA · A6543AA · A6563AA A6564AA · A6571AA · A6573AA	26

REPUESTOS GRIFERÍA

SERIE CERAPLAN III



Acabado: Neutro	Ref.	Dónde se usa	€/Ud.
Aireadores	B960754AA	B0772AA · B0773AA	5
	A960321AA	B0768AA · B0767AA	10
	A960537AA	B0718AA · B0716AA	5



Acabado: Neutro	Ref.	Dónde se usa	€/Ud.
Manetas	B961117AA	B0772AA · B0773AA · B0897AA B0715AA · B0718AA · B0716AA	15
	B961115AA	B0768AA · B0767AA	15
	B961116AA	A6383AA · A6382AA	15



Acabado: Neutro	Ref.	Dónde se usa	€/Ud.
Cartuchos monomando	B961491NU	B0772AA · B0773AA · B0718AA B0716AA · B0768AA · B0767AA	15
	A960500NU	A6383AA · A6382AA	19



Acabado: Neutro	Ref.	Dónde se usa	€/Ud.
Kit Easy-Fix	B960608NU	B0772AA · B0773AA · B0768AA · B0767AA	5



Acabado: Neutro	Ref.	Dónde se usa	€/Ud.
Válvula automática	A962991AA	B0772AA · B0773AA · B0767AA	26

SERIE CERALINE



Acabado: Neutro	Ref.	Dónde se usa	€/Ud.
Aireadores	A963369AA	BC197AA	15
	B960381NU	BC199AA	10
	B960889NU	BC193AA · BC268AA	10



Acabado: Neutro	Ref.	Dónde se usa	€/Ud.
Rótula bidé	A960019AA	BC197AA	19



Acabado: Neutro	Ref.	Dónde se usa	€/Ud.
Manetas	A962397AA	A6939AA · A6940AA	15
	B961520AA	BC193AA · BC268AA · BC197AA BC199AA · BC200AA	15



Acabado: Neutro	Ref.	Dónde se usa	€/Ud.
Cartuchos monomando	A960500NU	A6939AA · A6940AA	19
	B961476NU	BC193AA · BC268AA	19
	B961478NU	BC199AA	19
	B961480NU	BC200AA	19



Acabado: Neutro	Ref.	Dónde se usa	€/Ud.
Kit Easy-Fix	B964702NU	BC193AA · BC268AA · BC197AA	5



Acabado: Neutro	Ref.	Dónde se usa	€/Ud.
Válvula automática	A962991AA	BC193AA · BC197AA	26

REPUESTOS GRIFERÍA

SERIE CERAFLEX



Acabado: Neutro	Ref.	Dónde se usa	€/Ud.
Aireadores	B961383AA	B1708AA · B1709AA · B1710AA · B1711AA B1713AA · B1714AA · B1715AA	5
	B960294AA	B1716AA	5
	A960321AA	B1718AA · B1825AA	10
	A960537AA	B1721AA	5



Acabado: Neutro	Ref.	Dónde se usa	€/Ud.
Rótula bidé	A960063AA	B1718AA · B1825AA	19



Acabado: Neutro	Ref.	Dónde se usa	€/Ud.
Manetas	B961375AA	B1708AA · B1709AA · B1710AA · B1713AA · B1714AA B1718AA · B1825AA · B1721AA	30
	B961377AA	B1711AA · B1715AA	15
	B961379AA	B1716AA	15
	A861131AA	A6758AA · A6757AA	15



Acabado: Neutro	Ref.	Dónde se usa	€/Ud.
Cartuchos monomando	A861156NU	B1708AA · B1709AA · B1710AA · B1711AA · B1713AA B1714AA · B1715AA · B1718AA · B1825AA · B1721AA B1719AA	43
	B964932NU	B1716AA	15
	A960500NU	A6758AA · A6757AA	19



Acabado: Neutro	Ref.	Dónde se usa	€/Ud.
Kit Easy-Fix	A964520NU	B1708AA · B1709AA · B1710AA · B1711AA · B1713AA B1714AA · B1715AA · B1718AA · B1825AA · B1721AA B1719AA	5
	B960608NU	B1716AA	5



Acabado: Neutro	Ref.	Dónde se usa	€/Ud.
Válvula automática	A962991AA	B1708AA · B1711AA · B1716AA · B1718AA	26

TERMOSTÁTICAS

CERATHERM



Acabado: Neutro	Ref.	Dónde se usa	€/Ud.
Aireadores	A960395NU	A4623AA	15
	A961132AA	A5550AA	10



Acabado: Neutro	Ref.	Dónde se usa	€/Ud.
Cartuchos termostáticos	A962229NU	A4623AA · A5550AA · A6424AA A4618AA · A6367AA	32
	A963564NU	A5620AA · A4662AA	48

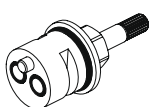

Acabado: Neutro	Ref.	Dónde se usa	€/Ud.
Cartucho caudal/inversor	A962568NU	A4623AA	40
	A963400NU	A4618AA · A5550AA · A5550AA A6367AA · A6424AA	15
	A962480NU	A5620AA	45
	A960898NU	A4662AA	25

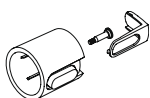

Acabado: Neutro	Ref.	Dónde se usa	€/Ud.
Maneta caudal	A962871AA	A4623AA · A4618AA	28
	A962233AA	A5550AA · A6367AA	30
	A860936AA	A6424AA	30
	A962388AA	A5620AA · A4662AA	30

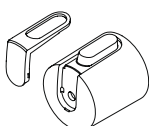

Acabado: Neutro	Ref.	Dónde se usa	€/Ud.
Maneta temperatura	A962871AA	A4623AA · A4618AA	28
	A962233AA	A5550AA · A6367AA	30
	A860936AA	A6424AA	30
	A962388AA	A5620AA · A4662AA	30

TONIC II

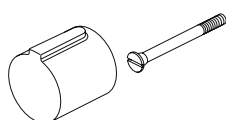

Acabado: Neutro	Ref.	Dónde se usa	€/Ud.
Maneta caudal	A962388AA	A6345AA · A6344AA	30

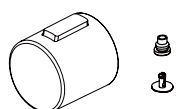

Acabado: Neutro	Ref.	Dónde se usa	€/Ud.
Maneta temperatura	A860907AA	A6345AA · A6344AA	30

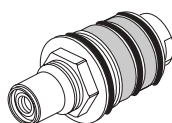

Acabado: Neutro	Ref.	Dónde se usa	€/Ud.
Cartucho termostático	A963564NU	A6345AA · A6344AA	48

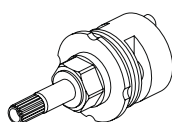

Acabado: Neutro	Ref.	Dónde se usa	€/Ud.
Cartucho caudal/inversor	A962480NU	A6345AA	45

REPUESTOS SANITARIOS

SERIE TONIC II



Acabado: Neutro	Ref.	Dónde se usa	€/Ud.
Kit fijación a suelo inodoro/bidé	TT0257919	K316001 · K316901 · K316201 K317301 · K523801	5



Acabado: Neutro	Ref.	Dónde se usa	€/Ud.
Kit fijación oculta inodoro o bidé suspendidos	TT0299327	K315801 · K316701 · K523601	25



Acabado: Cromo brillo	Ref.	Dónde se usa	€/Ud.
Bisagras cierre amortiguado	TV110AA	K706501	60



Acabado: Blanco	Ref.	Dónde se usa	€/Ud.
Juego de topes asiento Tonic II	TV10767	K706501	10

SERIE STRADA II



Acabado: Neutro	Ref.	Dónde se usa	€/Ud.
Kit fijación a suelo inodoro/bidé	TT0257919	T296801 · T296901	5



Acabado: Neutro	Ref.	Dónde se usa	€/Ud.
Kit fijación oculta inodoro o bidé suspendidos	TT0293851	T299701 · T297101	20



Acabado: Cromo brillo	Ref.	Dónde se usa	€/Ud.
Strada II anclaje soft	J4666BJ	T360101	25









Acabado: Cromo brillo	Ref.	Dónde se usa	€/Ud.
Strada II bisagras soft	TV716BJ	T360101	60



Acabado: Blanco	Ref.	Dónde se usa	€/Ud.
Juego de topes asiento Tonic II	EV46467	T360101	10

REPUESTOS SANITARIOS

SERIE CONNECT AIR

	<p>Acabado: Neutro</p> <p>Kit fijación a suelo para inodoro y bidé</p>	Ref. TT0257919	Dónde se usa E013701	€/Ud. 5
	<p>Acabado: Neutro</p> <p>Fijación para inodoro a suelo tanque alto</p>	Ref. TT0293851	Dónde se usa E004201 · E018001 E004301 · E004901	€/Ud. 20
	<p>Acabado: Cromo Brillo</p> <p>Kit fijación oculta inodoro / bidé suspendidos</p>	Ref. TT0299598	Dónde se usa E005401 · E026601 E008201 · E008701	€/Ud. 25
	<p>Acabado: Neutro</p> <p>Bisagras y anclaje caída normal</p>	Ref. TV09767	Dónde se usa E036501	€/Ud. 25
	<p>Acabado: Blanco</p> <p>Anclaje asiento soft</p>	Ref. TV04767	Dónde se usa E036601	€/Ud. 30
	<p>Acabado: Blanco</p> <p>Bisagras asiento soft</p>	Ref. TV04867	Dónde se usa E036601	€/Ud. 45
	<p>Acabado: Blanco</p> <p>Juego topes asiento fino</p>	Ref. TV16567	Dónde se usa E036501 · E036601	€/Ud. 10

SERIE CONNECT



Acabado: Neutro	Ref.	Dónde se usa	€/Ud.
Kit fijación a suelo para inodoro y bidé	TT0257919	E803701 · E039701 · E042901 E803401 · E052401	5



Acabado: Neutro	Ref.	Dónde se usa	€/Ud.
Kit fijación oculta inodoro o bidé suspendidos	TT0299327	E047901 · E771801 · E772201	25



Acabado: Cromo Brillo	Ref.	Dónde se usa	€/Ud.
Bisagras y anclaje caída normal	EV286AA	E712801 · E772301	25



Acabado: Cromo Brillo	Ref.	Dónde se usa	€/Ud.
Anclaje asiento con cierre amortiguado	EV287AA	E712701 · E772401	25



Acabado: Blanco	Ref.	Dónde se usa	€/Ud.
Bisagra asiento con cierre amortiguado	T299067	E712701 · E772401	42



Acabado: Blanco	Ref.	Dónde se usa	€/Ud.
Topes asiento envolvente	K785401	E712701 · E712801	10



Acabado: Blanco	Ref.	Dónde se usa	€/Ud.
Topes asiento fino	TV16567	E772301 · E772401	10

REPUESTOS SANITARIOS

SERIE CONNECT SPACE



Acabado: Neutro	Ref.	Dónde se usa	€/Ud.
Kit fijación a suelo para inodoro y bidé	TT0257919	E120001 · E119601	5



Acabado: Neutro	Ref.	Dónde se usa	€/Ud.
Kit fijación oculta inodoro o bidé suspendidos	TT0299327	E121701 · E119201	25



Acabado: Cromo Brillo	Ref.	Dónde se usa	€/Ud.
Bisagras y anclaje caída normal	EV286AA	E129001 · E772301	25



Acabado: Cromo Brillo	Ref.	Dónde se usa	€/Ud.
Anclaje asiento con cierre amortiguado	EV287AA	E129101 · E772401	25



Acabado: Blanco	Ref.	Dónde se usa	€/Ud.
Bisagra asiento con cierre amortiguado	T299067	E129101 · E772401	42



Acabado: Blanco	Ref.	Dónde se usa	€/Ud.
Topes asiento envolvente	K785401	E712301 · E712401	10



Acabado: Neutro	Ref.	Dónde se usa	€/Ud.
Topes asiento fino	TV16567	E772301 · E772401	10

SERIE CONNECT FREEDOM



Acabado: Neutro	Ref.	Dónde se usa	€/Ud.
Kit fijación a suelo para inodoro y bidé	TT0257919	E120001 · E119601	5



Acabado: Cromo Brillo	Ref.	Dónde se usa	€/Ud.
Bisagras y anclaje caída normal	EV286AA	E121701 · E119201	25



Acabado: Cromo Brillo	Ref.	Dónde se usa	€/Ud.
Anclaje asiento con cierre amortiguado	EV287AA	E129001 · E772301	25



Acabado: Blanco	Ref.	Dónde se usa	€/Ud.
Bisagra asiento con cierre amortiguado	T299067	E129101 · E772401	42



Acabado: Blanco	Ref.	Dónde se usa	€/Ud.
Topes asiento envolvente	K785401	E129101 · E772401	10



Acabado: Blanco	Ref.	Dónde se usa	€/Ud.
Topes asiento fino	TV16567	E712301 · E712401	10

REPUESTOS SANITARIOS

SERIE TESI



Acabado: Neutro	Ref.	Dónde se usa	€/Ud.
Kit fijación a suelo para inodoro y bidé	TT029931	T007701 · T353701 T353601 · T008201 T008701 · T354001	5



Acabado: Cromo Brillo	Ref.	Dónde se usa	€/Ud.
Kit fijación oculta inodoro / bidé suspendidos TESI	TT0299598	T007901 · T355201 T354701 · T354601	25



Acabado: Cromo Brillo	Ref.	Dónde se usa	€/Ud.
Bisagras y anclaje caída normal	TV09767	T352801	25



Acabado: Blanco	Ref.	Dónde se usa	€/Ud.
Anclaje asiento con cierre amortiguado	TV04767	T352701	30



Acabado: Blanco	Ref.	Dónde se usa	€/Ud.
Bisagra asiento con cierre amortiguado	TV04867	T352701	45



Acabado: Neutro	Ref.	Dónde se usa	€/Ud.
Topes asiento fino	TV04967	T352801 · T352701	10

SERIE ESEDRA



Acabado: Neutro	Ref.	Dónde se usa	€/Ud.
Kit fijación a suelo para inodoro	TT0257919	T282001 · 7281201 · T300801 T300901 · T281301	5



Acabado: Neutro	Ref.	Dónde se usa	€/Ud.
Kit fijación oculta inodoro / bidé suspendidos	TT0299598	T281401 · T278601 T278701 · T281501	25



Acabado: Cromo Brillo	Ref.	Dónde se usa	€/Ud.
Bisagras y anclaje caída normal	TV09767	T318101 · T318601	25



Acabado: Cromo brillo	Ref.	Dónde se usa	€/Ud.
Anclaje asiento con cierre amortiguado	TV04767	T318201 · T318301	30



Acabado: Blanco	Ref.	Dónde se usa	€/Ud.
Bisagra asiento con cierre amortiguado	TV04867	T318201 · T318301	45



Acabado: Blanco	Ref.	Dónde se usa	€/Ud.
Topes asiento fino	TV64267	T318101 · T318201 T318301 · T318601	10

REPUESTOS SANITARIOS

SERIE EUROVIT



Acabado: Neutro	Ref.	Dónde se usa	€/Ud.
Kit fijación a suelo para inodoro	TT0257919	V337201 · V002001 · V337001 · V002101	5



Acabado: Neutro	Ref.	Dónde se usa	€/Ud.
Kit fijación vertical a suelo	J118067	E877401	5



Acabado: Cromo Brillo	Ref.	Dónde se usa	€/Ud.
Bisagra asiento Eurovit normal	K7310BJ	W302601	20



Acabado: Blanco	Ref.	Dónde se usa	€/Ud.
Bisagra asiento Eurovit cierre amortiguado	W303601	W303001	28



Acabado: Blanco	Ref.	Dónde se usa	€/Ud.
Topes asiento envolvente	K785401	E712701 · E712801	10

SERIE SIMPLICITY



Acabado: Cromo Brillo	Ref.	Dónde se usa	€/Ud.
Bisagra asiento Simplicity normal	K7310BJ	W302601	28



Acabado: Blanco	Ref.	Dónde se usa	€/Ud.
Bisagra asiento Simplicity cierre amortiguado	W303601	W303001	28



Acabado: Blanco	Ref.	Dónde se usa	€/Ud.
Topes asiento envolvente	K785401	E131601 - E131801	10

REPUESTOS SANITARIOS

PARA TODAS LAS SERIES



Acabado: Neutro	Ref.	Dónde se usa	€/Ud.
Alimentación inferior cisterna	R7586BG	Todos las cisternas A/I	26



Acabado: Neutro	Ref.	Dónde se usa	€/Ud.
Alimentación lateral cisterna	R7585BG	Todos las cisternas A/L	26



Acabado: Cromo Brillo	Ref.	Dónde se usa	€/Ud.
Biela y junta alimentación cisterna	R643067	Todas las alimentaciones de tanque bajo R7585BG · R7586BG	5



Acabado: Cromo Brillo	Ref.	Dónde se usa	€/Ud.
Mecanismo de descarga universal	R7588AA	Todas las cisternas	37



Acabado: Cromo Brillo	Ref.	Dónde se usa	€/Ud.
Botón doble pulsador	RR646099	Descarga universal R7588AA	5



Acabado: Cromo Brillo	Ref.	Dónde se usa	€/Ud.
Embellecedor botón pulsador	RR646072	Descarga universal R7588AA	5



Acabado: Blanco	Ref.	Dónde se usa	€/Ud.
Junta de cierre mecanismo universal	D968205NU	R7588AA	4



Acabado: Neutro	Ref.	Dónde se usa	€/Ud.
Junta de unión cisterna - inodoro	RR641678	Todas las cisternas tanque bajo	4



Acabado: Neutro	Ref.	Dónde se usa	€/Ud.
Kit unión cisterna - inodoro	R640267	Todas las cisternas	7



Acabado: Neutro	Ref.	Dónde se usa	€/Ud.
Tapón agujero lateral inodoro (ud.)	WW965948	Todos los inodoros con agujeros laterales	4



Acabado: Neutro	Ref.	Dónde se usa	€/Ud.
Junta descarga inodoro tanque alto	T606900	Todos los inodoros tanque alto	4



Acabado: Neutro	Ref.	Dónde se usa	€/Ud.
Kit anti ruido	T604900	Todos los inodoros y bidés suspendidos	15



Acabado: Neutro	Ref.	Dónde se usa	€/Ud.
Codo desagüe a 90° sin desplazamiento horizontal	WW965742	Consultar modelos	20



Acabado: Neutro	Ref.	Dónde se usa	€/Ud.
Codo desagüe a 90° con 6 cm desplazamiento horizontal	T682067	Consultar modelos	20

ÍNDICE DE REFERENCIAS

Referencia	Pág.	PVP.	Referencia	Pág.	PVP.	Referencia	Pág.	PVP.
A1000NU	93	100	A6367AA	92	175	A7011AA	53	135
A1300NU	35	90	A6382AA	71	109	A7012AA	53	155
A2406AA	113	40	A6383AA	71	129	A7013AA	54	155
A3306AA	111	20	A6424AA	92	140	A7014AA	52	135
A3330AA	111	25	A6542AA	62	125	A7015AA	53	145
A4109AA	111	30	A6543AA	62	125	A7016AA	54	145
A4618AA	92	215	A6545AA	64	125	A7017AA	52	135
A4623AA	92	275	A6548AA	65	149	A7018AA	52	125
A4662AA	93	240	A6549AA	64	165	A7019AA	52	125
A5550AA	92	225	A6559AA	62	115	A7020AA	54	225
A5620AA	93	260	A6560AA	62	115	A7023AA	54	215
A5686AA	102	420	A6563AA	62	135	A7025AA	54	235
A5689AA	103	345	A6564AA	63	135	A7027AA	55	225
A5691AA	103	370	A6565AA	63	125	A7029AA	55	235
A5776AA	127	230	A6571AA	63	180	A7030AA	55	145
A5777AA	127	45	A6573AA	63	185	A7032AA	56	175
A5833AA	102	480	A6575AA	63	175	A7033AA	55	210
A5834AA	103	345	A6578AA	64	210	A7036AA	56	89
A5862AA	103	370	A6581AA	64	130	A7037AA	56	119
A5948NU	35	120	A6583AA	64	190	A7101AA	40	165
A5948NU	44	120	A6690AA	126	500	A7102AA	41	165
A6120AA	360	1250	A6691AA	126	600	A7103AA	41	155
A6133NU	360	455	A6692AA	123	500	A7106AA	41	175
A6143AA	120	375	A6699AA	126	750	A7107AA	41	175
A6144AA	120	375	A6700AA	126	800	A7108AA	41	165
A6145AA	120	425	A6701AA	126	850	A7110AA	42	285
A6146AA	120	425	A6702AA	126	700	A7111AA	42	275
A6326AA	32	240	A6703AA	126	750	A7112AA	42	285
A6327AA	32	230	A6704AA	126	775	A7113AA	42	285
A6328AA	33	330	A6757AA	86	89	A7114AA	42	275
A6329AA	33	320	A6758AA	86	109	A7115AA	43	275
A6330AA	32	210	A6865AA	125	220	A7116AA	43	265
A6331AA	32	200	A6866AA	125	240	A7118AA	43	165
A6332AA	32	270	A6868AA	125	480	A7120AA	43	185
A6333AA	33	260	A6869AA	125	550	A7121AA	43	220
A6334AA	33	300	A6870AA	125	400	A7126AA	44	99
A6335AA	33	320	A6873AA	124	530	A7127AA	44	129
A6336AA	34	240	A6874AA	124	550	A7265AA	40	155
A6337AA	34	260	A6939AA	79	119	A7266AA	40	145
A6338AA	34	320	A6940AA	79	99	A7267AA	40	155
A6342AA	34	109	A7007AA	52	145	A7268AA	40	145
A6343AA	34	149	A7008AA	53	145	A860873AA	112	45
A6344AA	93	235	A7009AA	55	240	A9103MY	388	52
A6345AA	93	270	A7010AA	53	135	A9104MY	386	34

Referencia	Pág.	PVP.
A9105AA	387	28
A9106AA	388	90
A9108MY	389	58
A9109MY	388	47
A9110MY	388	57
A9111AA	386	91
A9112AA	387	26
A9114AA	387	69
A9115AA	384	10
A9116AA	384	14
A9117AA	384	27
A9118AA	384	30
A9119AA	389	37
A9120AA	385	26
A9121AA	385	26
A9122AA	385	26
A9123AA	385	26
A9124AA	386	47
A9125AA	386	47
A9126AA	387	31
A9127AA	389	31
A9128MY	389	58
A9129AA	385	29
A9130AA	384	30
A9131AA	384	51
A9132AA	389	26
A9133MY	388	42
B0024AA	111	210
B0025AA	111	300
B0029AA	112	20
B0383MY	110	275
B0384MY	110	300
B0385MY	110	350
B0386MY	110	400
B0387MY	110	275
B0388MY	110	350
B0389MY	110	450
B0390MY	110	350
B0391MY	110	400
B0716AA	71	120
B0718AA	71	140
B0767AA	70	100
B0768AA	70	90
B0772AA	70	100

Referencia	Pág.	PVP.
B0773AA	70	120
B0897AA	70	100
B0952AA	134	195
B0954AA	134	225
B0956AA	134	205
B0960AA	134	225
B1708AA	84	80
B1709AA	84	70
B1710AA	84	70
B1711AA	84	80
B1713AA	84	95
B1714AA	85	85
B1715AA	85	95
B1716AA	85	115
B1718AA	85	80
B1719AA	86	105
B1721AA	86	120
B1759AA	108	70
B1760AA	108	70
B1761AA	104	155
B1762AA	104	155
B1763AA	104	165
B1764AA	104	165
B1765AA	106	100
B1766AA	106	100
B1825AA	85	70
B2231AA	108	45
B2232AA	108	45
B2233AA	104	100
B2234AA	104	100
B2237AA	104	110
B2238AA	104	110
B2239AA	106	70
B2240AA	106	70
B8295AA	121	300
B8296AA	121	240
B8297AA	121	320
B8299AA	121	260
B8300AA	121	250
B8301AA	121	120
B9400AA	109	15
B9401AA	109	25
B9402AA	109	17
B9403AA	109	28

Referencia	Pág.	PVP.
B9412AA	105	60
B9414AA	105	70
B9415AA	105	73
B9417AA	105	83
B9418AA	105	65
B9419AA	105	78
B9420AA	112	35
B9421AA	112	40
B9422AA	112	45
B9428AA	112	45
B9429AA	112	55
B9435AA	110	180
B9436AA	111	190
B9442AA	110	210
B9443AA	110	270
B9444AA	111	75
B9445AA	111	100
B9446AA	111	53
B9448AA	113	20
B9454AA	107	49
B9467AA	113	20
B9468AA	112	20
B9501AA	105	55
B9502AA	105	65
B9503AA	105	60
B9504AA	105	70
B9506AA	107	32
B9507AA	107	42
BC091AA	122	150
BC092AA	122	140
BC095AA	122	155
BC096AA	122	145
BC097AA	122	165
BC098AA	122	155
BC099AA	122	170
BC100AA	122	160
BC103AA	122	175
BC104AA	122	165
BC105AA	123	185
BC106AA	123	175
BC108AA	123	225
BC109AA	123	230
BC110AA	124	265
BC111AA	124	275

ÍNDICE DE REFERENCIAS

Referencia	Pág.	PVP.	Referencia	Pág.	PVP.	Referencia	Pág.	PVP.
BC112AA	124	285	E036601	175	75	E503801	284	55
BC113AA	124	295	E039701	183	205	E503901	284	75
BC114AA	124	225	E042901	183	180	E504001	284	85
BC115AA	124	250	E047901	182	260	E504101	286	75
BC116AA	124	275	E052401	182	190	E504201	286	80
BC117AA	123	95	E066801	278	100	E504501	285	75
BC118AA	124	140	E066901	278	125	E504601	285	75
BC129AA	136	100	E073401	175	145	E504701	285	85
BC135AA	136	125	E074101	248	125	E504801	285	85
BC143AA	136	140	E074201	248	110	E504901	285	95
BC174AA	134	160	E074401	248	100	E505001	285	95
BC176AA	135	210	E074601	248	95	E505101	285	75
BC178AA	135	230	E074701	249	100	E505201	286	75
BC193AA	78	90	E074801	248	70	E505301	285	85
BC197AA	78	90	E119201	190	185	E505401	286	85
BC199AA	78	130	E119601	191	200	E505601	284	95
BC200AA	78	115	E120001	190	130	E505801	284	105
BC268AA	78	80	E120201	197	125	E506101	284	115
BC292AA	135	115	E121701	190	245	E567101	380	179
BC294AA	135	160	E129001	191	40	E567201	380	179
BC295AA	135	145	E129101	191	75	E607001	197	215
BC297AA	136	220	E131701	224	25	E607201	196	215
C002099	229	35	E131801	224	50	E607401	196	200
C6612AA	228	225	E139201	264	465	E607501	196	240
C6621NU	229	35	E139301	264	465	E711401	251	70
C895100	361	35	E139401	264	465	E711401	255	70
D5705AC	381	30	E306601	360	1850	E712701	184	75
E004201	174	220	E306701	360	2000	E712801	184	40
E004301	174	260	E306801	360	2250	E713701	251	80
E004901	174	295	E322867	319	32	E713801	250	82
E005401	174	300	E3239OS	318	155	E713901	250	80
E008201	174	340	E3239SG	318	155	E714001	250	80
E008701	174	375	E3239WG	318	155	E771801	182	235
E013701	175	240	E3240OS	318	200	E772201	182	180
E018001	174	155	E3240SG	318	200	E772301	184	40
E026601	174	185	E3240WG	318	200	E772401	184	75
E027301	276	530	E3242OS	319	270	E772901	250	100
E027401	276	400	E3242SG	319	270	E794501	250	85
E027901	276	285	E3242WG	319	270	E797001	184	125
E028901	276	205	E3243OS	319	205	E797101	184	125
E029601	276	155	E3243SG	319	205	E799501	182	125
E034701	268	175	E3243WG	319	205	E799701	182	155
E034801	268	225	E4465AA	229	60	E803401	182	180
E036501	175	40	E4465GN	229	65	E803501	182	210

Referencia	Pág.	PVP.
E803701	183	185
E804601	190	215
E819501	196	340
E822501	197	65
E822601	197	55
E876901	224	100
E877301	224	75
E877401	220	55
EV10667	229	35
F2605AA	127	115
J117767	247	5
J196067	381	20
J3417AA	348	26
J3494AA	381	70
J377201	381	150
J377301	381	150
K077701	248	185
K077801	248	215
K078201	248	240
K078601	248	325
K193301	348	138
K1933YK	348	196
K193401	349	156
K1934YK	349	216
K193501	349	173
K1935YK	349	232
K193601	349	232
K1936YK	349	292
K193701	349	292
K1937YK	349	352
K193801	350	319
K1938YK	350	379
K193901	348	139
K1939YK	348	197
K229401	361	135
K229501	361	135
K229601	361	135
K229901	361	195
K230001	361	205
K230101	361	215
K240201	351	156
K2402YK	351	216
K240301	351	156
K2403YK	351	216

Referencia	Pág.	PVP.
K240401	351	163
K2404YK	351	222
K240501	351	163
K2405YK	351	222
K240601	351	215
K2406YK	351	275
K240701	351	215
K2407YK	351	275
K240801	351	245
K2408YK	351	303
K240901	351	245
K2409YK	351	303
K255101	349	319
K2551YK	349	379
K255201	350	340
K2552YK	350	400
K255301	350	362
K2553YK	350	422
K255401	350	379
K2554YK	350	438
K274501	361	195
K274601	361	209
K274701	361	250
K274801	361	275
K274901	361	209
K275001	361	275
K315801	160	415
K316001	161	340
K316201	160	315
K316701	160	500
K316901	161	400
K317301	160	425
K404901	161	242
K517201	348	143
K5172YK	348	203
K517301	348	161
K5173YK	348	221
K517401	348	204
K5174YK	348	263
K517501	348	227
K5175YK	348	287
K517601	348	167
K5176YK	348	226
K517701	348	248

Referencia	Pág.	PVP.
K5177YK	348	308
K517801	349	168
K5178YK	349	227
K517901	349	163
K5179YK	349	222
K518001	349	215
K5180YK	349	275
K518101	349	239
K5181YK	349	298
K518201	349	245
K5182YK	349	303
K518301	349	268
K5183YK	349	328
K518401	349	280
K5184YK	349	339
K518501	349	297
K5185YK	349	357
K518601	349	303
K5186YK	349	363
K518701	350	311
K5187YK	350	370
K518801	350	319
K5188YK	350	379
K518901	350	330
K5189YK	350	390
K519001	350	339
K5190YK	350	399
K519101	350	353
K5191YK	350	412
K519201	350	363
K5192YK	350	423
K523601	160	255
K523801	160	245
K553801	380	155
K706501	161	85
K710667	380	20
K751501	380	35
K818701	350	297
K8187YK	350	357
K8190FR	341	270
K8190FS	341	270
K8190FT	341	270
K8190FU	341	270
K8190FV	341	270

ÍNDICE DE REFERENCIAS

Referencia	Pág.	PVP.
K8214FR	340	300
K8214FS	340	300
K8214FT	340	300
K8214FU	340	300
K8214FV	340	300
K8215FR	340	335
K8215FS	340	335
K8215FT	340	335
K8215FU	340	335
K8215FV	340	335
K8216FR	340	425
K8216FS	340	425
K8216FT	340	425
K8216FU	340	425
K8216FV	340	425
K8218FR	341	340
K8218FS	341	340
K8218FT	341	340
K8218FU	341	340
K8218FV	341	340
K8219FR	341	355
K8219FS	341	355
K8219FT	341	355
K8219FU	341	355
K8219FV	341	355
K8220FR	341	385
K8220FS	341	385
K8220FT	341	385
K8220FU	341	385
K8220FV	341	385
K8221FR	341	380
K8221FS	341	380
K8221FT	341	380
K8221FU	341	380
K8221FV	341	380
K822367	380	35
K8227FR	342	425
K8227FS	342	425
K8227FT	342	425
K8227FU	342	425
K8227FV	342	425
K8230FR	342	485
K8230FS	342	485
K8230FT	342	485

Referencia	Pág.	PVP.
K8230FU	342	485
K8230FV	342	485
K8232FR	342	525
K8232FS	342	525
K8232FT	342	525
K8232FU	342	525
K8232FV	342	525
K8234FR	343	425
K8234FS	343	425
K8234FT	343	425
K8234FU	343	425
K8234FV	343	425
K8237FR	343	480
K8237FS	343	480
K8237FT	343	480
K8237FU	343	480
K8237FV	343	480
K8256FR	343	550
K8256FS	343	550
K8256FT	343	550
K8256FU	343	550
K8256FV	343	550
K8276FR	344	535
K8276FS	344	535
K8276FT	344	535
K8276FU	344	535
K8276FV	344	535
K8277FR	344	655
K8277FS	344	655
K8277FT	344	655
K8277FU	344	655
K8277FV	344	655
K8281FR	345	515
K8281FS	345	515
K8281FT	345	515
K8281FU	345	515
K8281FV	345	515
K8284FR	345	575
K8284FS	345	575
K8284FT	345	575
K8284FU	345	575
K8284FV	345	575
K8285FR	345	655
K8285FS	345	655

Referencia	Pág.	PVP.
K8285FT	345	655
K8285FU	345	655
K8285FV	345	655
K8304FR	346	600
K8304FS	346	600
K8304FT	346	600
K8304FU	346	600
K8304FV	346	600
K8306FR	346	700
K8306FS	346	700
K8306FT	346	700
K8306FU	346	700
K8306FV	346	700
K8319FR	344	675
K8319FS	344	675
K8319FT	344	675
K8319FU	344	675
K8319FV	344	675
K8320FR	346	725
K8320FS	346	725
K8320FT	346	725
K8320FU	346	725
K8320FV	346	725
K881001	220	120
K936367	347	45
K936467	347	60
KV169FR	347	40
KV169FS	347	40
KV169FT	347	40
KV169FU	347	40
KV169FV	347	40
LV23567	360	120
LV238AA	360	78
R206601	253	50
R330901	253	45
R6625AA	253	70
R6625AA	265	70
S212201	372	65
S216401	372	70
S216501	372	70
S216701	372	75
S216801	372	75
S263701	366	65
S263901	366	50

Referencia	Pág.	PVP.
S266401	366	50
S307701	373	350
S310601	373	425
S310801	373	180
S312301	367	145
S312601	368	150
S312801	369	250
S406601	373	55
S4078LJ	373	60
S407901	373	75
S453301	367	55
S453336	367	55
S453379	367	55
S4533GQ	367	55
S453601	368	55
S453636	368	55
S453679	368	55
S4536GQ	368	55
S454201	369	50
S454236	369	50
S454279	369	50
S4542GQ	369	50
S454501	368	50
S454536	368	50
S454579	368	50
S4545GQ	368	50
S593901	381	195
S612001	381	105
S6360AC	377	85
S6363AC	377	50
S6450AC	376	19
S6452AC	376	20
S6453AC	376	22
S6454AC	376	25
S6455AC	376	26
S6457AC	376	28
S6458AC	376	29
S6459AC	376	30
S6460AC	376	40
S6461AC	376	45
S6462AC	376	55
S6472AC	377	65
S6473AC	377	55
S6474AC	377	55

Referencia	Pág.	PVP.
S6481AC	377	20
S688467	373	35
S8703AA	372	100
S911067	372	10
S9233MY	381	40
T007701	204	170
T007901	204	195
T008201	205	180
T008701	205	175
T056301	252	75
T056401	252	65
T056501	252	60
T056601	252	55
T056701	252	50
T262601	206	110
T278601	212	185
T278701	212	220
T281201	212	140
T281301	212	90
T281401	212	145
T281501	212	115
T282001	213	166
T282801	214	100
T283401	213	120
T292801	246	215
T292901	267	225
T295901	267	250
T296101	267	250
T296201	266	225
T296301	266	225
T296501	266	275
T296601	266	275
T296701	266	275
T296801	166	265
T296901	166	220
T297101	166	230
T298001	267	440
T298101	267	325
T299301	284	225
T299401	247	205
T299501	247	205
T299601	247	100
T299701	166	375
T299801	266	325

Referencia	Pág.	PVP.
T299901	266	325
T300001	246	245
T300101	246	380
T300201	246	465
T300601	246	600
T300801	212	180
T300901	212	215
T318101	214	75
T318201	214	40
T318301	214	75
T318601	214	40
T3189AA	323	50
T3190AA	323	70
T323601	214	100
T3248AA	323	30
T3339BH	322	310
T3340BH	322	425
T3341BH	322	435
T3342BH	322	460
T3343BH	322	485
T3344BH	322	560
T3345BH	322	420
T3346BH	322	465
T3347BH	322	505
T3348BH	322	535
T3349BH	322	610
T3354BH	322	100
T3355BH	322	105
T3356BH	322	110
T3357BH	322	115
T3358BH	322	135
T3359BH	322	160
T350801	277	175
T350901	277	150
T351001	277	125
T351101	277	90
T351801	277	65
T351901	277	65
T352701	206	75
T352801	206	40
T353601	204	245
T353701	204	210
T354001	204	110
T354601	204	270

ÍNDICE DE REFERENCIAS

Referencia	Pág.	PVP.
T354701	204	235
T355201	204	135
T356801	206	110
T359501	246	600
T360101	166	85
T360401	267	325
T371701	205	385
T422901	252	45
T423001	252	45
T603767	361	50
T604900	228	15
T682067	411	20
T8520AA	348	41
TT0257919	400	5
U8405FF	306	300
U8405FW	306	300
U8405FX	306	300
U8405WG	306	300
U8406FF	306	325
U8406FW	306	325
U8406FX	306	325
U8406WG	306	325
U8407FF	306	350
U8407FW	306	350
U8407FX	306	350
U8407WG	306	350
U8408FF	307	400
U8408FW	307	400
U8408FX	307	400
U8408WG	307	400
U8409FF	307	450
U8409FW	307	450
U8409FX	307	450
U8409WG	307	450
U8410FF	309	95
U8410FW	309	95
U8410FX	309	95
U8410WG	309	95
U8412FF	309	120
U8412FW	309	120
U8412FX	309	120
U8412WG	309	120
U8413FF	310	150
U8413FW	310	150

Referencia	Pág.	PVP.
U8413FX	310	150
U8413WG	310	150
U8414FF	310	165
U8414FW	310	165
U8414FX	310	165
U8414WG	310	165
U8415FF	310	175
U8415FW	310	175
U8415FX	310	175
U8415WG	310	175
U8416FF	310	195
U8416FW	310	195
U8416FX	310	195
U8416WG	310	195
U8417FF	311	215
U8417FW	311	215
U8417FX	311	215
U8417WG	311	215
U8419FF	309	330
U8419FW	309	330
U8419FX	309	330
U8419WG	309	330
U8421FF	309	365
U8421FW	309	365
U8421FX	309	365
U8421WG	309	365
U8425AA	311	150
U8426AA	311	150
U8427AA	311	150
U842867	308	85
U8593FF	307	500
U8593FW	307	500
U8593FX	307	500
U8593WG	307	500
U8599FY	308	175
U8600FY	308	120
U8601FY	308	130
U8602FY	308	150
U8603FY	308	170
U8615AA	311	150
V002001	221	155
V002101	221	155
V200101	252	35
V302701	253	50

Referencia	Pág.	PVP.
V302801	253	56
V337001	221	155
V337201	221	155
V493201	220	100
K553901	380	155
V914001	255	30
V921001	255	28
VV610010	231	115
VV620001	231	45
VV622405	231	15
VV641001	229	45
VV641015	229	105
VV656004	228	130
VV656006	228	145
VV659044	228	60
VV659046	228	65
VV659055	228	100
W302601	221	25
W303001	221	50
W3091AA	230	30
W309967	230	175
W370067	230	95
W407501	254	35
W407901	254	35
W420201	255	70
W424001	254	40
W434001	254	38
W444001	254	45
W740601	220	110
WW965742	411	20

ÍNDICE PRODUCTOS DESCATALOGADOS

Referencia	PVP.	Referencia	PVP.	Referencia	PVP.
E053501	--	R4313FF	--	S6479AC	--
E0537OS	--	R4313WG	--	S648136	--
E0537SG	--	R4320FA	--	S6481LJ	--
E0537WG	--	R4320FC	--	S6481MY	--
E109901	--	R4320FE	--	S6481RN	--
E1103OS	--	R4320FF	--	SN8326AA	--
E1103SG	--	R4320WG	--	T0045OV	--
E1103WG	--	R4321FA	--	T0045PH	--
E714101	--	R4321FC	--	T0045PU	--
E803601	--	R4321FE	--	T0045VI	--
E803801	--	R4321FF	--	T0046OV	--
J3291AA	--	R4321WG	--	T0046PH	--
J3746AA	--	R4322FA	--	T0046PU	--
K077601	--	R4322FC	--	T0046VI	--
K078101	--	R4322FE	--	T0047OV	--
K083301	--	R4322FF	--	T0047PH	--
K083401	--	R4322WG	--	T0047PU	--
K083701	--	R4323FA	--	T0047VI	--
K083901	--	R4323FC	--	T0048OV	--
K086201	--	R4323FE	--	T0048PH	--
K086801	--	R4323FF	--	T0048PU	--
K087001	--	R4323WG	--	T0048VI	--
R4309FA	--	R4324FA	--	T0050OV	--
R4309FC	--	R4324FC	--	T0050PH	--
R4309FE	--	R4324FE	--	T0050PU	--
R4309FF	--	R4324FF	--	T0050VI	--
R4309WG	--	R4324WG	--	T0051OV	--
R4310FA	--	R4330SA	--	T0051PH	--
R4310FC	--	R4331SA	--	T0051PU	--
R4310FE	--	R4332SA	--	T0051VI	--
R4310FF	--	R4333SA	--	T0052OV	--
R4310WG	--	R4335SA	--	T0052PH	--
R4311FA	--	R4336SA	--	T0052PU	--
R4311FC	--	R4357WG	--	T0052VI	--
R4311FE	--	R4358WG	--	T0054OV	--
R4311FF	--	R4359WG	--	T0054PH	--
R4311WG	--	R4360WG	--	T0054PU	--
R4312FA	--	R4361WG	--	T0054VI	--
R4312FC	--	S307801	--	T429301	--
R4312FE	--	S6456AC	--	W306101	--
R4312FF	--	S646636	--	W306201	--
R4312WG	--	S6466LJ	--	W311101	--
R4313FA	--	S6466MY	--	W320901	--
R4313FC	--	S6466RN	--	W407301	--
R4313FE	--	S6478AC	--	W412601	--

CONDICIONES DE VENTAS

TARIFA 2019

MODELOS Y COLORES

Los modelos y colores que indicamos en nuestros catálogos y folletos, pueden ser modificados o suprimidos, previo aviso al comprador. Las medidas que indicamos son aproximadas pero deben aceptarse las tolerancias propias de estos materiales.

Los colores de los productos fotografiados son indicativos ya que están sujetos a las típicas variaciones causadas por los trabajos fotográficos y de estampación.

Los montajes fotográficos están realizados con fines estéticos y no indican soluciones de instalación. Para este fin se utilizan las cotas de los diseños técnicos.

PRECIOS

Los precios que figuran en esta tarifa son unitarios, de venta al público y no incluyen el IVA.

Los precios indicados en la Tarifa de Precios son orientativos, estando sujetos a cualquier variación previo aviso al comprador. Los productos serán facturados al precio que figure en la confirmación de cada pedido por Ideal Standard.

Las cantidades indicadas como palet/caja no corresponden necesariamente con un palet físico ni con una caja de producto. En algunos casos es así, pero no necesariamente. Esta cantidad es la indicada para acceder a los descuentos acordados.

PLAZOS DE ENTREGAS DE MATERIAL

El plazo de entrega aproximado del producto marcado como "disponible en stock" será de 10 días. Esta disponibilidad de stock en nuestros almacenes es orientativa y puede verse afectada por roturas de stock o cualquier otro motivo. Confirmar disponibilidad real a través de nuestro departamento de Atención al cliente.

Para los productos marcados como "no disponible en stock" el plazo aproximado de entrega será de 4-6 semanas aproximado. Este plazo podrá verse acortado o alargado en función de la disponibilidad de producto. Por favor, consultar disponibilidad orientativa con nuestro departamento de atención al cliente antes de comprometerse a un plazo definitivo.

DEVOLUCIONES

Dentro del marco establecido por el R.D.L 1/2007 de 16 de Noviembre, T. R. de la Ley General para la defensa de los consumidores y Usuario y otras leyes complementarias y corresponde con 2 años después de la adquisición del producto.

La garantía pierde su validez por daños causados por incorrecta puesta en marcha o instalación, por uso inadecuado del producto, por daños provocados por condiciones ambientales adversas, por vandalismo y por manipulación indebida del equipo por personal no autorizado.

DEVOLUCIONES

Ideal Standard Iberia no acepta devoluciones de pedido. En caso de potenciales problemas, se negociaran soluciones individuales ad-hoc.

Bajo ninguna circunstancia, Ideal Standard admitirá devoluciones de materiales: usados, descatalogados, especiales o sin su embalaje original, entendiéndose por especiales aquellos no incluidos en esta tarifa.

Los pedidos aceptados no podrán ser anulados en los casos siguientes:

- Cuando se haya expedido el material
- Cuando se trate de mercancía de fabricación especial, debidamente encargada por el cliente y que ya se encuentre en fase de ejecución.

En el supuesto de que el Cliente haya incumplido, de forma total o parcial, anteriores acuerdos con Ideal Standard, ésta se reserva el derecho de anular pedidos pendientes de entrega.

RESERVA DE PROPIEDAD

La propiedad será transferida al Comprador al cumplir los términos del contrato de compra-venta, una vez liquidada la deuda completamente. Si el Comprador ha ordenado otro tipo de bienes o productos, cualquier pago será contemplado para cubrir facturas anteriores con adeudos pendientes.

CONTACTO

Para información sobre nuestros productos o sobre la red de ventas, pueden contactar con nosotros a través de nuestra web:

www.idealstandard.es

o a través de:

ATENCIÓN AL CLIENTE

Tel.: +34 93 561 80 00

E-mail: atencioncliente@idealstandard.com

El teléfono está disponible los días laborables en horario de oficina.

5

Años de Garantía
En todos nuestros productos

GARANTÍA

CONDICIONES GENERALES DE GARANTÍA Mediante este documento, IDEAL STANDARD, S.L.U., concede una garantía comercial, en lo sucesivo CG, sobre los productos que comercializa, de acuerdo a las condiciones que se expresan a continuación:

1. La amplitud y la extensión de la presente CG viene determinada por la reparación, el coste de las piezas de recambio, la mano de obra y, si aplicase, la sustitución del producto amparada por la misma dentro del territorio de la Unión Europea. Las ventas efectuadas fuera de la Unión Europea no están bajo el alcance de esta garantía salvo pacto expreso de IDEAL STANDARD, S.L.U.

2. La reparación o sustitución de toda pieza no conforme, así como modificaciones posteriores al producto solicitadas por el cliente, deberán ser realizadas por personal autorizado por IDEAL STANDARD, S.L.U. En este caso, IDEAL STANDARD, S.L.U. responderá de las faltas de conformidad en relación a la ejecución de la reparación, sustitución o cambio durante los 6 meses posteriores a su realización.

3. IDEAL STANDARD recogerá y entregará los productos sin coste alguno para el usuario final siempre y cuando se encuentren dentro de España. Para aquellos que no cumplan este requisito deberán tramitarlo con el punto de venta o distribuidor donde hayan sido adquiridos y al efecto, expresamente, se señala que esta garantía no cubre los gastos de transporte ni los riesgos derivados del transporte de su producto a y desde IDEAL STANDARD o a y desde la SAT de IDEAL STANDARD al Cliente final o Distribuidor, respecto de los productos comercializados fuera de España.

3. La duración de la presente CG será de 5 años a contar desde la fecha de factura o ticket de compra, o en su caso el albarán de entrega si la fecha de éste fuese posterior a la de los documentos anteriores. El cambio o reparación del producto no prorroga el periodo de garantía inicial.

5. IDEAL STANDARD, S.L.U. garantiza sus productos y sus componentes contra cualquier falta de conformidad, siempre y cuando los mismos hayan sido objeto de una correcta instalación (conforme a la normativa en vigor y las instrucciones indicadas para su montaje, mantenimiento y conservación) y se haya hecho el uso debido y para el que fueron concebidos.

IDEAL STANDARD o su Servicio Técnico se reservan el derecho de sustituir el modelo defectuoso por otro de similares características que el recibido, independientemente del precio que tuviera el modelo a reparar en el momento que el usuario realizara la compra inicial.

8. Quedan excluidos de la presente CG:

a. Los daños que se deriven del transporte, si este no ha sido realizado por la IDEAL STANDARD, S.L.U.

b. Los daños derivados de una incorrecta instalación, de manipulaciones o reparaciones efectuadas por personal no autorizado por IDEAL STANDARD, S.L.U., así como los daños que se deban al desgaste natural, malos tratos, uso y mantenimiento incorrecto, impropio, anormal o diferente al usual y/o a lo indicado en las correspondientes instrucciones. El desgaste, muestras de una manipulación incorrecta, uso indebido, maltrato, golpes, caídas, suciedad, serán tratados como reparación fuera de garantía bajo presupuesto.

c. Aquellos daños ocasionados por suciedad, incrustaciones, calcificación u otros defectos físicos, químicos o electroquímicos.

d. Los daños que objetivamente no sean susceptibles de imputar al fabricante.

9. En el caso de que el producto entregado al consumidor no sea conforme al contrato de compraventa del producto según lo establecido en el artículo 125 del Real Decreto Legislativo 1/2007 de 16 de Noviembre de 2007, el consumidor deberá informar al VENDEDOR de dicha falta de conformidad en un plazo de dos meses desde que tuvo conocimiento de la misma. Asimismo, para ejercer los derechos de sustitución del producto, rebaja del precio o, en su caso, resolución del contrato de compraventa, el consumidor deberá dirigirse al VENDEDOR del producto.

10. Esta garantía no afecta los derechos legales del consumidor que le confiere el Real Decreto Legislativo 1/2007 de 16 de Noviembre de 2007 en el caso de Reino de España o a lo dispuesto en la Directiva 1999/44/CE del 25 de Mayo de 1999 y en las respectivas leyes nacionales de transposición de la misma.

Para más información sobre la gama
de los productos de Ideal Standard
póngase en contacto con:

Ideal Standard Iberia

Av. de Francia 4, 1º, pta 1
46023 - Valencia
España

Tel: +34 93 561 80 00

www.idealstandard.es
atencioncliente@idealstandard.com



Ideal Standard

www.idealstandard.es