

CATÁLOGO
GENERAL

2018



BUZONES



CAJAS FUERTES



SEGURIDAD



RECICLAJE & ORDEN



CON PRECIOS
IVA NO INCLUIDO

 **ARREGUI**

www.arregui.es

ÍNDICE DE PRODUCTOS

BUZONES



CAJAS FUERTES



SEGURIDAD



RECICLAJE & ORDEN



ESTILOS: VANGUARDISTA **VA** **TAMAÑOS:** S (Capacidad: DIN A-5) / M (Capacidad: DIN A-4) / L (Capacidad: Revistas)

BUZONES METÁLICOS

TAMAÑO **S**

ACERO Y ACERO INOX

LINE	Pag. 18	SMART	Pag. 19	COMPACT	Pag. 20	ZAGUAN	Pag. 21
 VA NEW							

TAMAÑO **M**

DIME	Pag. 22	FIGURE	Pag. 23	PREMIUM	Pag. 24	DECO	Pag. 25	VISIT	Pag. 26
		 VA NEW							
VILLA	Pag. 27	HOME	Pag. 28						
									

TAMAÑO **L**

AMERICANO	Pag. 29	PLATE	Pag. 30	AURA	Pag. 31	URBAN	Pag. 32	PREMIUM MAXI	Pag. 33
		 VA		 VA		 VA			

TAMAÑO **M**

TAMAÑO **L**

ALUMINIO

RESIDENCIA	Pag. 34
	

RESIDENCIA MAXI	Pag. 35
	

ESTILOS: VANGUARDISTA **VA** **TAMAÑOS:** S (Capacidad: DIN A-5) / M (Capacidad: DIN A-4) / L (Capacidad: Revistas)

BUZONES DE PLÁSTICO

TAMAÑO **M**

CLASSIC Pag. 36	COSTA Pag. 37	MININOVA Pag. 38

TAMAÑO **L**

MARE Pag. 39
NEW

RECOGECARTAS Y BOCACARTAS

BOCARTAS RECOGECARTAS, PACK Pag. 40	BOCARTAS RECOGECARTAS, PACK MAXI Pag. 42

BUZÓN PAQUETERÍA

KANGUR Pag. 44

PAPELERA PARA GARAJE

PAPELERA Pag. 45

CESTAS DE PUBLICIDAD

CLÁSICO / CURVO Pag. 46

PANELES DE ANUNCIOS

PAN 40/ 50/ 70 Pag. 47

ACCESORIOS Y REPUESTOS

SEÑALÉTICA CORPÓREA Pag. 45	LIMPIADOR BUZONES Pag. 48	PUBLICIDAD NO Pag. 48	KIT FIJACIÓN VERJAS Pag. 49	SET DE CERRADURA Pag. 49
TARJETEROS PLÁSTICO Pag. 49	REPUESTOS CERRADURAS Pag. 50			



CAJAS FUERTES

CAMUFLADAS

BASA / CAJÓN	Pag. 52	GRID	Pag. 54	SOCKET	Pag. 55	BOX-IN	Pag. 56	COVER	Pag. 57
									NEW



SOBREPONER

PREMIER	Pag. 58	NEW STYLO	Pag. 59	CLASS LLAVE	Pag. 60	CLASS ELECTR.	Pag. 61
	NEW		NEW				



SOBREPONER

SUPRA ELECTRÓNICA	Pag. 62	SUPRA MOTORIZADA	Pag. 63
	NEW		NEW



SOBREPONER

FORMA EVOLUTION	Pag. 64	FORMA EVOLUTION RANURA	Pag. 65	FORMA C ELECTRÓNICA	Pag. 66	FORMA C PEANA	Pag. 67
	NEW		NEW				



SOBREPONER

PLUS-C ELECTR.+LLAVE	Pag. 68	PLUS-C LLAVE	Pag. 69	PLUS-C RANURA	Pag. 70	FORZA	Pag. 71
	NEW		NEW		NEW		



CAJAS FUERTES

EMPOTRAR

PREMIER Pag. 72	NEW STYLO Pag. 73	CLASS ELECTR. Pag. 74	IDEAL 5 Pag. 75
 NEW	 NEW		 NEW



EMPOTRAR

SUPRA Pag. 76	FORMA EVOLUTION Pag. 77	PLUS-C ELECTR. +LLAVE Pag. 78	PLUS-C LLAVE Pag. 79
 NEW	 NEW	 NEW	 NEW

IGNÍFUGAS

IGNÍFUGAS

SUPRA Pag. 80	RESIST Pag. 81
 NEW	 NEW

ARMEROS

GAMA BRACO Pag. 82	WOOD Pag. 83
	

HOTEL

STYLO Pag. 84	TRAVEL Pag. 85
 NEW	 NEW

ACCESORIOS Y REPUESTOS

LUZ LED INTERIOR Pag. 86	LLAVES Pag. 86
	

SEGURIDAD PARA OBJETOS

CAJAS DE CAUDALES

ELEGANT Pag. 88	CASHIER Pag. 88	POP-UP Pag. 89	BRIC Pag. 89	PRIVATE Pag. 90
HUCHA MAIL Pag. 91				

CONTENEDORES SECRETOS

BOOK Pag. 92	CHEF Pag. 92	NOVEL Pag. 93	POTY Pag. 93	SECRET CAN / SPRAY Pag. 94
		NEW	NEW	

GESTIÓN DE LLAVES

KEEPER Pag. 95	KEEPER MÓVIL Pag. 95	ARMARIO REGULABLE Pag. 96	ARMARIO FIJO Pag. 97	QUICK Pag. 97
NEW				

CANDADOS

SERIE COMBI STANDARD Pag. 98	SERIE COMBI COLOR Pag. 98	SERIE COMBI DESIGN Pag. 98	MOSQUETÓN COMBI Pag. 98	SERIE COMBI ARCO FLEXIBLE Pag. 99
			NEW	NEW
SERIE COMBI LLAVE EMERG. Pag. 99	SERIE ALUMINIO COMBI Pag. 99	SERIE ALUMINIO LLAVE Pag. 99	SERIE STANDARD Pag. 100	
NEW		NEW		



SEGURIDAD PARA OBJETOS

CANDADOS

SERIE PRIME Pag. 100	SERIE COLOR Pag. 101	SERIE DESIGN Pag. 101	SERIE TSA ARCO FLEXIBLE Pag. 102	SERIE TSA COMBI Pag. 102
SERIE TSA LLAVE Pag. 102	STRONG Pag. 103	PORTA CANDADO Pag. 103	CABLE MINI LOOP Pag. 103	

SEGURIDAD BICI Y MOTO

CABLES BICI COLORES Pag. 104	CABLE BICI BÁSICO Pag. 104	CABLE LOOP Pag. 105	HORQUILLAS Pag. 105	ESPIRALES BICI Pag. 106
ESPIRAL CON SOPORTE Pag. 107	ESPIRAL MATCH COMBINACIÓN Pag. 107	CADENA REVEST. TEXTIL Pag. 108	CADENA Pag. 108	CADENA REVEST. PLÁSTICO Pag. 109
ARTICULADO Pag. 109	ANCLAJE ACERO Pag. 110	DISCOS MOTO Pag. 110	INFLADOR BICI Pag. 110	

ESPEJOS PARA SEGURIDAD Y VIGILANCIA

ESPEJOS Pag. 111



SEGURIDAD PARA PUERTAS Y VENTANAS

BLOCKER Pag. 112 **ALARMAS** Pag. 112



🔒 SEGURIDAD PARA PERSONAS / INFANTIL

EXPOSITOR	Pag. 113	MALETÍN	Pag. 113	KIT PROTECCIÓN	Pag. 113

PROTECCIÓN ESQUINAS DE MOBILIARIO

PERFILES PROTECTORES	Pag. 114	PROTECTORES ESQUINAS	Pag. 114	PROTECTORES ESQUINAS	Pag. 115	PROTECTORES ESQUINAS MÁXI	Pag. 115	PROTECTORES ESQUINAS OSO/GATO	Pag. 115

PROTECCIÓN ESQUINAS Y CANTOS DE PARED

BANDA PROTECTORA	Pag. 116	PROTECTOR CANTOS Y ESQUINAS	Pag. 116

CIERRES SEGURIDAD MULTIUSO

CIERRE REGULABLE	Pag. 117	CIERRE MULTIUSOS CORTO	Pag. 117	CIERRE MULTIUSOS LARGO	Pag. 117

PROTECCIÓN PARA ENCHUFES

PROTECTOR GIRATORIO	Pag. 118	PROTECTOR FIJO	Pag. 118

PROTECCIÓN PARA ARMARIOS

CIERRES DE SEGURIDAD	Pag. 118	HORQUILLA DE SEGURIDAD	Pag. 118



SEGURIDAD PARA PERSONAS / INFANTIL

PROTECCIÓN PARA VENTANAS

LIMITADOR APERT. VENT. MARIPOSA Pag. 119	LIMITADOR APERT. VENT. VENTOSA Pag. 119	LIMITADOR APERT. VENT. METÁLICOS Pag. 119	RECOGEDOR CUERDA CORTINAS Pag. 119

PROTECCIÓN PARA PUERTAS

SALVADEDOS Pag. 120	TOPE PUERTA Pag. 120	PROTECTOR FLEXIBLE BISAGRAS Pag. 121	TOPE BISAGRAS Pag. 121

PROTECCIÓN PARA CAJONES

PROTECCIÓN PARA BAÑO

CIERRE MAGNÉTICO Pag. 122	CIERRE CAJONES Pag. 122	ADAPTADOR PARA WC Pag. 123	PROTECTOR GRIFO BANERA Pag. 123	ANTIDESLIZANTE BANERA Pag. 123

PROTECCIÓN PARA AUTOMÓVILES Y PASEO

ESPEJO RETROVISOR Pag. 124	KIT COCHE Pag. 124	GANCHO PARA SILLA Pag. 124

PROTECCIÓN PARA COCINAS Y DORMITORIO

PROTECTOR MANDOS COCINA Pag. 125	BARRERA CAMA Pag. 125	ALFOMBRA PUZZLE Pag. 125

EASYLIFE SENIOR

CINTA ANTI DESLIZANTE Pag. 126 	CINTA LUMINISCENTE Pag. 127 	BRAZALETE REFLECTANTE AJUST. Pag. 128 	BRAZALETE REFLECTANTE LED Pag. 128 	LUPA BOLSILLO CON LED Pag. 128 
PINZA DE ALCANCE Pag. 129 	LOCALIZADOR DE OBJETOS Pag. 129 	COJÍN GIRATORIO Pag. 130 	ASIDERO PORTÁTIL CON VENTOSA Pag. 130 	ABRIDOR UNIVERSAL Pag. 130 

SEGURIDAD PERSONAL

ALARMAS PERSONALES Pag. 131 

BOTIQUÍN

BOTIQUÍN Pag. 132 



RECICLAJE Y ORDEN

RECICLAJE Y ORDEN

BASIC	Pag. 134	VARIO	Pag. 135	STEP BIN	Pag. 136
					

TABURETES

TABURETE PLEGABLE	Pag. 137
	NEW

MALETAS PORTA-HERRAMIENTAS

D-ACS01	Pag. 139	D-ACS04	Pag. 139	D-ACS06	Pag. 140	D-ACP01	Pag. 140
							

CAJA HERRAMIENTAS	Pag. 141
	

SOPORTES Y GANCHOS

SOPORTE MURAL PLEGABLE 2 BICIS	Pag. 142	SOPORTE MURAL PLEGABLE BICI	Pag. 142	GANCHO CUELGA BICIS	Pag. 143	SOPORTE MULTIFUNCIONAL	Pag. 143	GANCHO CON SOPORTE BALDA	Pag. 144
									
GANCHO UNIVERSAL DOBLE	Pag. 144	GANCHO DOBLE	Pag. 145	GANCHOS UNIVERSALES	Pag. 145				
									

CENICEROS EXTERIOR

GEO	Pag. 146
	





BUZONES INDIVIDUALES

 **ARREGUI**

www.arregui.es



BUZONES METÁLICOS ACERO / INOX



www.arregui.es



BUZONES ACERO / INOX

LINE



FICHA TÉCNICA

Capacidad buzón	- ■■■■ +
Resistencia anticorrosiva	■ ■ ■ ■
Estanteidad	✓
Código EAN13	8425181 *
EXTRAS	La cerradura queda oculta y protegida bajo la visera.

MEDIDAS (mm)

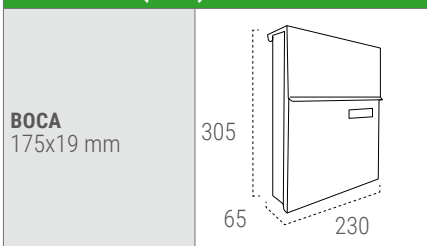

PACKAGING (mm)



ACERO



BLANCO E6801
* 731550
18,19€



AMARILLO E6808
* 731734
18,19€



NEGRO E6804
* 731710
18,19€



MAGENTA E6806
* 731727
18,19€



La boca y la cerradura quedan ocultas y protegidas por la visera del buzón.



SMART



FICHA TÉCNICA

Capacidad buzón	- ■■■■ +
Resistencia anticorrosiva	■■■■
Resist. anticorr. INOX	■■■■
Estanqueidad	-
Código EAN13	8425181 *
EXTRAS	Doble función: buzón + recogecartas. Ideal para espacios reducidos.

MEDIDAS (mm)

BOCA
175x20 mm

**BOCA
RECOGECARTAS:**
178x20 mm

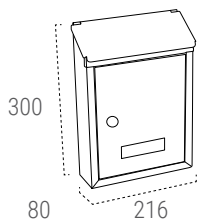

PACKAGING (mm)

PACKAGING
320x230x480 mm



ACERO INOX



Vista frontal



Vista trasera

INOX E5727
* 157275
30,49€

ACERO



BLANCO E5721
* 157213
15,12€



VERDE E5723
* 157237
15,12€



NEGRO E5724
* 157244
15,12€



Uso como buzón para exterior.



Uso como recogecartas, combinado con un bocacartas



BUZONES METÁLICOS ACERO / INOX



www.arregui.es



COMPACT



FICHA TÉCNICA

Capacidad buzón	- ■■■■ +
Resistencia anticorrosiva	■■■■
Resist. anticorr. INOX	■■■■
Estanqueidad	✓
Código EAN13	8425181 *
EXTRAS	Cumple con la norma europea EN-13724 Ideal para espacios reducidos.

MEDIDAS (mm)

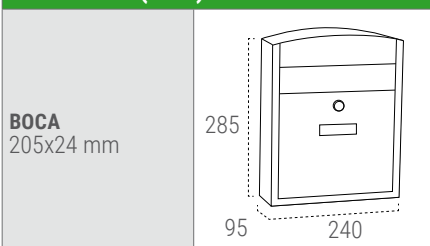

PACKAGING (mm)



ACERO INOX



INOX E5737
* 157374
32,03€

ACERO



BLANCO E5731
* 157312
16,66€



NEGRO E5734
* 157343
16,66€



VERDE E5733
* 157336
16,66€



ROJO E5736
* 731772
16,66€



Su tamaño de boca admite sobres C5.



Su tamaño permite colocarlo en espacios reducidos.



ZAGUÁN



FICHA TÉCNICA

Capacidad buzón	- ■■■■ +
Resistencia anticorrosiva	■■■■
Resist. anticorr. INOX	■■■■
Estanqueidad	✓
Código EAN13	8425181 *
EXTRAS	<p>Doble función:</p> <ul style="list-style-type: none"> - Cumple con la norma europea EN-13724 - buzón + recogecartas. - Modulable. Permite su colocación en agrupaciones. (No dispone de agujeros laterales de unión).

ACERO INOX



Vista frontal



Vista trasera

INOX E5757
* 157572
34,34€

ACERO

MEDIDAS (mm)

BOCA
182x30 mm

**BOCA
RECOGECARTAS:**
197x20 mm

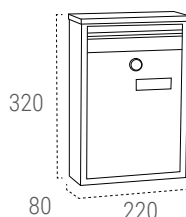

PACKAGING (mm)

PACKAGING
320x220x80 mm



VERDE E5753
* 157534
18,96€



NEGRO E5754
* 157541
18,96€



BLANCO E5751
* 157510
18,96€



ROJO E5756
* 731789
18,96€



Combinado con un bocacartas el buzón puede utilizarse como recogecartas, de manera que la correspondencia se deposita desde el exterior del muro y se recoge desde el interior.



DIME



FICHA TÉCNICA

Capacidad buzón	- ■■■■ +
Resistencia anticorrosiva	■■■■
Resist. anticorr. INOX	■■■■
Estanqueidad	✓
Código EAN13	8425181 *
EXTRAS	Cumple con la norma europea EN-13724 Modulable. Permite su colocación en agrupaciones. (No dispone de agujeros laterales de unión).

MEDIDAS (mm)

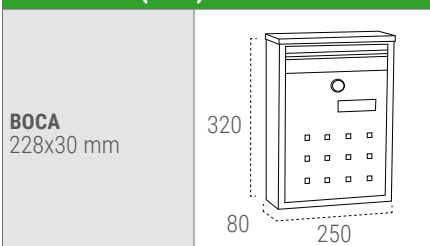

PACKAGING (mm)



ACERO INOX



INOX V1327

* 113271

36,90€

ACERO



PLATA V1322

* 113226

21,53€



BLANCO V1321

* 113219

21,53€



NEGRO V1324

* 113240

21,53€



Permite agrupar varios buzones en espacios reducidos.



FIGURE



FICHA TÉCNICA

Capacidad buzón	- ■ ■ ■ ■ +
Resistencia anticorrosiva	■ ■ ■ ■
Estanqueidad	✓
Código EAN13	8425181 * *
EXTRAS	Cumple con la norma europea EN-13724 La cerradura queda oculta y protegida bajo la visera.

ACERO



BLANCO E6701
* 731451
26,65€



PLATA E6702
* 731819
26,65€

MEDIDAS (mm)

BOCA 228x35 mm	
--------------------------	--

PACKAGING (mm)

PACKAGING 368x275x35 mm	
-----------------------------------	--



NEGRO E6704
* 731826
26,65€



IRIDIUM E6705
* 731833
26,65€



La cerradura queda oculta y protegida bajo la visera.

BUZONES METÁLICOS ACERO / INOX



www.arregui.es



PREMIUM



FICHA TÉCNICA

Capacidad buzón	- ■■■■ +
Resistencia anticorrosiva	■■■■
Resist. anticorr. INOX	■■■■
Estanqueidad	✓
Código EAN13	8425181 *
EXTRAS	Cumple con la norma europea EN-13724 Acabados con atractivos estampados.

MEDIDAS (mm)

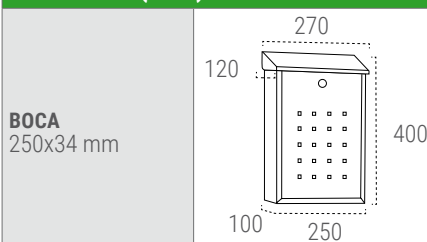

PACKAGING (mm)



ACERO INOX



INOX E5607
* 156070
47,15€

ACERO



BLOSSOM E5608
* 156087
29,47€



SPARK E5606
* 156063
29,47€



BLANCO E5601
* 156018
26,65€



VERDE E5603
* 156032
26,65€



NEGRO E5604
* 156049
26,65€



Personaliza y decora la entrada de una vivienda.



DECO



FICHA TÉCNICA

Capacidad buzón	- ■■■■ +
Resistencia anticorrosiva	■■■■
Resist. anticorr. INOX	■■■■
Estanqueidad	✓
Código EAN13	8425181 * 157077
EXTRAS	Cumple con la norma europea EN-13724

MEDIDAS (mm)

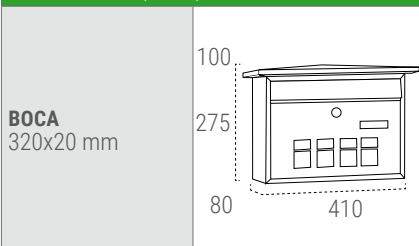

PACKAGING (mm)



ACERO INOX



INOX E5707
* 157077
44,08€

ACERO



NEGRO E5704
* 157046
23,58€



BLANCO E5701
* 157015
23,58€



VERDE E5703
* 157039
23,58€



Buzón de acero inoxidable altamente resistente a la intemperie.



Su diseño con tejadillo decora la entrada a viviendas o inmuebles.

BUZONES METÁLICOS ACERO / INOX

ARREGUI

www.arregui.es

M

VISIT



FICHA TÉCNICA

Capacidad buzón	- ■■■■ +
Resistencia anticorrosiva	■■■■
Resist. anticorr. INOX	■■■■
Estanqueidad	✓
Código EAN13	8425181 *
EXTRAS	Cumple con la norma europea EN-13724

MEDIDAS (mm)

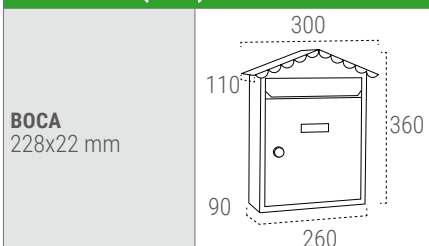

PACKAGING (mm)



ACERO INOX



INOX E5747
* 157473
43,05€

ACERO



BLANCO E5741
* 157411
22,55€



VERDE E5743 *
157435
22,55€



NEGRO E5744
* 157442
22,55€



Su diseño con tejadillo decora la entrada a viviendas o inmuebles.



VILLA



FICHA TÉCNICA

Capacidad buzón	- ■■■■ +
Resistencia anticorrosiva	■■■■
Estanqueidad	✓
Código EAN13	8425181 *
EXTRAS	Cumple con la norma europea EN-13724 Buzón de gran robustez con bisagras inoxidable que refuerzan su resistencia a la intemperie.

ACERO



GRAFITO E5005
* 150054
26,65€

MEDIDAS (mm)

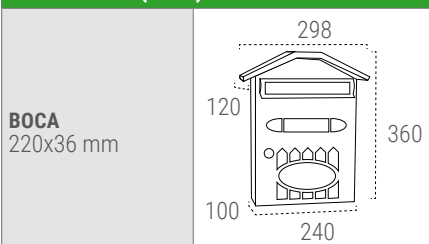

PACKAGING (mm)



BLANCO E5001
* 150016
26,65€



NEGRO TEXTURADO E5004
* 150047
26,65€



VERDE E5003 *
150030
26,6€



ROJO INGLÉS E5002
* 150023
26,65€



BUZONES METÁLICOS ACERO / INOX



www.arregui.es



HOME



FICHA TÉCNICA

Capacidad buzón	- ■■■■ +
Resistencia anticorrosiva	■■■■
Resist. anticorr. INOX	■■■■
Estanqueidad	✓
Código EAN13	8425181 *
EXTRAS	Cumple con la norma europea EN-13724

MEDIDAS (mm)

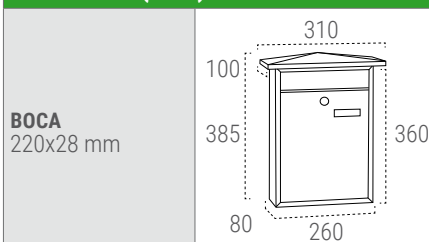

PACKAGING (mm)



ACERO INOX



INOX E5717

* 157176

45,10€

ACERO



BLANCO E5711

* 157114

24,60€



VERDE E5713 *

157138

24,60€



NEGRO E5714

* 157145

24,60€



USA MAIL



FICHA TÉCNICA

Capacidad buzón	- ■■■■ +
Resistencia anticorrosiva	☑☑☑☑
Estanqueidad	-
Código EAN13	8019635 *

MEDIDAS (mm)

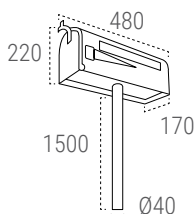

PACKAGING (mm)

PACKAGING
225x485x175 mm



ACERO



NEGRO D-USA/N
* 803506
33,83€



SILVER D-USA/S
* 803513
33,83€



ROJO D-USA/R
* 803520
33,83€



AMERICANO



FICHA TÉCNICA

Capacidad buzón	- ■■■■ +
Resistencia anticorrosiva	☑☑☑☑
Estanqueidad	-
Código EAN13	8425181 *

MEDIDAS (mm)

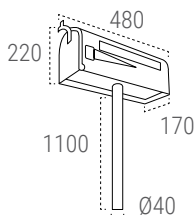

PACKAGING (mm)

PACKAGING
225x485x175 mm



ALUMINIO



ALUMINIO AMERICANO E2101
* 121016
39,98€



PLATE



ACERO



FICHA TÉCNICA

Capacidad buzón	- ■■■■ +
Resistencia anticorrosiva	■■■■
Estanqueidad	✓
Código EAN13	8425181 *
EXTRAS	Cumple con la norma europea EN-13724
	La cerradura queda oculta y protegida bajo la visera.
	Dispone de retenedor de cartas.



WORDS E6512
* 722961
33,31€

MEDIDAS (mm)

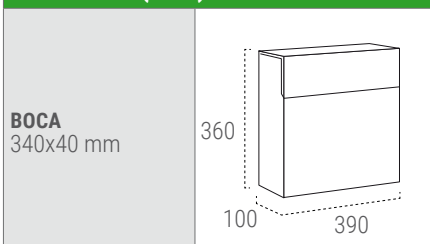

PACKAGING (mm)



BLANCO E6501
* 722947
30,75€



El cuerpo incorpora un retenedor para la correspondencia.



AURA



FICHA TÉCNICA

Capacidad buzón	- ■■■■ +
Resistencia anticorrosiva	■ ■ ■ ■
Resist. anticorr. INOX	■ ■ ■ ■
Estanqueidad	✓
Código EAN13	8425181 *

EXTRAS

Cuerpo de acero y puerta y tapa de boca de acero inoxidable, excepto acabados blanco y negro enteramente de acero.

El buzón Aura ha sido reconocido en diversas publicaciones de decoración.

Especial para catálogos, revistas, sobres grandes, etc

La visera y la puerta del buzón incluyen tapas laterales que previenen la entrada de agua de manera eficaz.

La puerta se detiene a 75° e incluye un cajón para almacenar la correspondencia.

Incorpora 4 toques separadores en la trasera que facilitan la instalación del buzón.

La cerradura incluye una nueva leva que facilita el cierre y la apertura de la puerta.

Cumple con la norma europea EN-13724

MEDIDAS (mm)

BOCA 295x35 mm	

PACKAGING (mm)

PACKAGING 325x380x120 mm	
------------------------------------	--

ACERO INOX



INOX E5405-12
* 154052
57,40€

ACERO



TECH SILVER E5415
* 154151
61,50€



Detalle textura TECH SILVER E5415



NEGRO E5404
* 723173
36,90€



BLANCO E5401
* 722930
36,90€



El buzón Aura ha sido reconocido en diversas publicaciones de decoración.



La puerta se detiene a 75° e incluye un cajón para almacenar la correspondencia

URBAN

ACERO INOX



FICHA TÉCNICA

Capacidad buzón	- ■■■■ +
Resist. anticorr. INOX	■■■■
Estanqueidad	✓
Código EAN13	8425181 *
EXTRAS	Cumple con la norma europea EN-13724 Especial para catálogos, revistas, sobres grandes, etc

MEDIDAS (mm)

BOCA 270x35mm	

PACKAGING (mm)

PACKAGING 415x320x155 mm	
-----------------------------	--



INOX E5907
* 159071
61,50€



Su diseño innovador se adapta a cualquier entorno



PREMIUM MAXI



FICHA TÉCNICA

Capacidad buzón	- ■■■■ +
Resistencia anticorrosiva	■■■■
Resist. anticorr. INOX	■■■■
Estanqueidad	✓
Código EAN13	8425181 *
EXTRAS	Cumple con la norma europea EN-13724 Especial para catálogos, revistas, sobres grandes, etc.

MEDIDAS (mm)

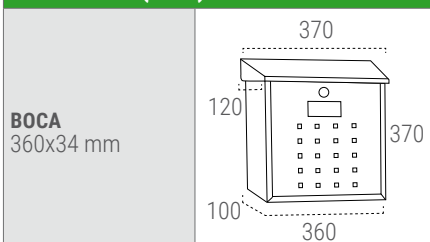

PACKAGING (mm)



ACERO INOX



INOX E5617
* 156179
51,25€

ACERO



BLANCO E5611
* 156117
30,75€



NEGRO E5614
* 156148
30,75€



El tamaño de la boca del buzón admite documentos DIN A4.



RESIDENCIA



FICHA TÉCNICA

Capacidad buzón	- ■ ■ ■ ■ +
Resistencia anticorrosiva	■ ■ ■ ■
Estanqueidad	-
Código EAN13	8425181 *
EXTRAS	<p>La trasera del buzón es de acero galvanizado.</p> <p>La tapa de boca dispone de un muelle que la mantiene cerrada.</p>

ALUMINIO



BLANCO E2611
* 126110
32,80€



VERDE E2613
* 126134
32,80€

MEDIDAS (mm)

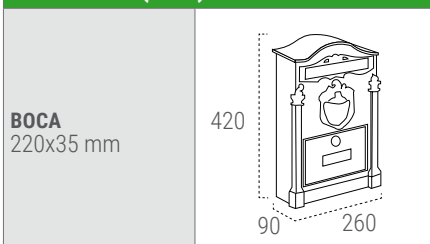

PACKAGING (mm)



NEGRO E2614
* 126141
32,80€



GRAFITO E2615
* 126158
32,80€





RESIDENCIA MAXI

ALUMINIO



FICHA TÉCNICA

Capacidad buzón	- ■■■■ +
Resistencia anticorrosiva	■■■■
Estanqueidad	-
Código EAN13	8019635 *
EXTRAS	La trasera del buzón es de acero galvanizado.

MEDIDAS (mm)

BOCA 230x35 mm	470	
	95	

PACKAGING (mm)

PACKAGING 475x300x100 mm	
------------------------------------	--



ROJO D-2152/R
* 804145
42,03€



BRONCE D-2152/B
* 804169
42,03€



VERDE OSCURO D-2152/V
* 804152
42,03€



NEGRO D-2152/N
* 804176
42,03€





CLASSIC



FICHA TÉCNICA

Capacidad buzón	- ■■■■ +
Resistencia anticorrosiva	NO CORROSIVO
Estanqueidad	-
Código EAN13	8425181 *
EXTRAS	Material: Poliestireno de gran resistencia..

MEDIDAS (mm)

BOCA 200x30 mm	

PACKAGING (mm)

PACKAGING 348x275x460 mm	
-----------------------------	--

PLÁSTICO



BLANCO E1071
* 721247
18,45€



VERDE E1073
* 721025
18,45€



NEGRO E1074
* 721032
18,45€





COSTA



FICHA TÉCNICA

Capacidad buzón	- ■■■■ +
Resistencia anticorrosiva	NO CORROSIVO
Estanqueidad	✓
Código EAN13	8425181 *
EXTRAS	Cumple con la norma europea EN-13724 Material: Poliestireno de gran resistencia

PLÁSTICO



BLANCO E5301
* 153017
20,50€

MEDIDAS (mm)

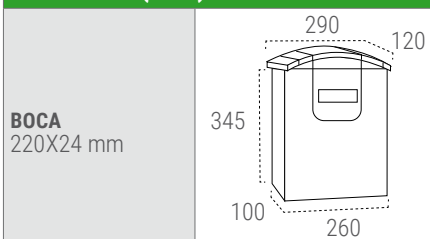

PACKAGING (mm)



NEGRO E5304
* 153048
20,50€





MININOVA



FICHA TÉCNICA

Capacidad buzón	- ■■■■ +
Resistencia anticorrosiva	NO CORROSIVO
Estanqueidad	✓
Código EAN13	8425181 *
EXTRAS	Material: Poliestireno de gran resistencia. La puerta se detiene a 80°.

PLÁSTICO



VERDE E5333
* 153338
22,55€

MEDIDAS (mm)

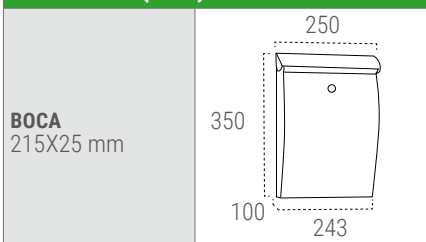

PACKAGING (mm)



BLANCO E5331
* 153314
22,55€



NEGRO E5334
* 153345
22,55€



La puerta se detiene a 80° permitiendo una cómoda recogida de la correspondencia.



MARE



FICHA TÉCNICA

Capacidad buzón	- ■■■■ +
Resistencia anticorrosiva	NO CORROSIVO
Estanqueidad	✓
Código EAN13	8425181 *
EXTRAS	Material: Poliestireno de gran resistencia

MEDIDAS (mm)

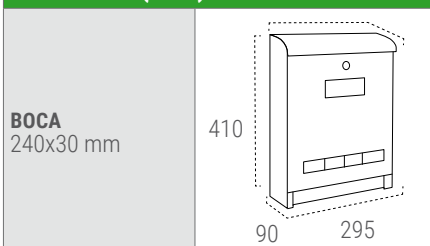

PACKAGING (mm)



PLÁSTICO



BLANCO E1061
* 734834
30,75€



GRIS E1065
* 734841
30,75€



BOCACARTAS

FICHA TÉCNICA

Resistencia anticorrosiva	☑☑☑☑
Estanqueidad	—
Código EAN13	8425181 *

EXTRAS

- Cumple con la Norma Europea: EN-13724
- Adaptable a recogecartas V4090.
- Material: Acero galvanizado excepto C-601 de acero inoxidable.

MEDIDAS (mm)

BOCA 230x30 mm	
PACKAGING 275x75x20 mm	

COLOR



INOXIDABLE ESPEJO C601
* 106013
22,04€



BLANCO C603
* 106037
16,91€



NEGRO TEXTURADO C604
* 106044
16,91€



VERDE C607
* 106075
16,91€



El bocacartas permite depositar la correspondencia desde el exterior de una puerta o verja.

RECOGECARTAS

FICHA TÉCNICA

Capacidad buzón	- ■■■■ +
Resistencia anticorrosiva	☑☑☑☑
Material	Acero galvanizado excepto V4097 de acero inoxidable.
Estanqueidad	—
Código EAN13	8425181 *

EXTRAS

- Cumple con la norma europea EN-13724
- Adaptable a bocacartas C-600.

MEDIDAS (mm)

BOCA 230x40 mm	
PACKAGING 265x300x145 mm	

COLOR



INOXIDABLE ESPEJO V4097
* 140970
57,40€

Vista trasera / vista delantera



Es la solución ideal para la recepción de correspondencia en adosados y viviendas unifamiliares.



BLANCO V4091
* 140918
36,90€



VERDE V4093
* 140932
36,90€



NEGRO TEXTURADO V4094
* 140949
36,90€

PACK BOCACARTAS Y RECOGECARTAS



FICHA TÉCNICA

Capacidad buzón	- ■■■■ +
Resistencia anticorrosiva	■ ■ ■ ■
Estanqueidad	-
Código EAN13	8425181 *
EXTRAS	Conjunto formado por bocacartas C600 y recogecartas V4090.

COLOR



Vista trasera / vista delantera
INOXIDABLE ESPEJO V4037
* 140376
78,93€



Vista trasera / vista delantera
NEGRO TEXTURADO V4034
* 140345
53,30€



Vista trasera / vista delantera
BLANCO V4031
* 140314
53,30€

MEDIDAS (mm)

**BOCA
BOCACARTAS**
230x30 mm

**BOCA
RECOGECARTAS**
230x40 mm

PACKAGING
265x310x145 mm



La combinación de bocacartas y recogecartas es una solución que ofrece privacidad en la recepción de la correspondencia.

BOCACARTAS MAXI

FICHA TÉCNICA

Resistencia anticorrosiva	☑☑☑☑
Estanqueidad	-
Material	Acero galvanizado excepto C-611 de acero inoxidable.
Código EAN13	8425181 *

EXTRAS

- Cumple con la Norma Europea: EN-13724
- Adaptable a recogecartas V4060 y V4070.

MEDIDAS (mm)

BOCA 325 x 30 mm	
PACKAGING 370x78x20 mm	

COLOR



INOXIDABLE ESPEJO C611
* 106112
23,58€



BLANCO C613
* 106136
18,45€



NEGRO TEXTURADO C614
* 106143
18,45€



VERDE C617
* 106174
18,45€



El bocacartas permite recepcionar la correspondencia evitando la entrada de personas ajenas a portales o inmuebles.

RECOGECARTAS MAXI

FICHA TÉCNICA

Capacidad buzón	- ■■■■ +
Resistencia anticorrosiva	☑☑☑☑
Estanqueidad	-
Material	Acero galvanizado excepto V4070 y aluminio V4060. Acero inoxidable V4077.
Código EAN13	8425181 *

EXTRAS

- Cumple con la Norma Europea: EN-13724
- Adaptable a bocacartas C-610.

MEDIDAS (mm)

BOCA 330x40 mm	
PACKAGING 375x330x145 mm	

ACERO INOXIDABLE



Vista trasera / vista delantera
ACERO INOXIDABLE ESPEJO V4077
* 140772
60,48€

ALUMINIO V4060



BLANCO V4061
* 140611
50,23€



NEGRO TEXTURADO V4064
* 140642
50,23€

ACERO V4070



BLANCO V4071
* 140710
39,98€



VERDE V4073
* 140734
39,98€



NEGRO TEXTURADO V4074
* 140741
39,98€

PACK MAXI



FICHA TÉCNICA

Capacidad boca	REVISTERO
Capacidad buzón	- ■■■ +
Resistencia anticorrosiva	■■■■
Estanqueidad	-
Código EAN13	8425181 *
EXTRAS	Conjunto formado por bocacartas C610 y recogecartas V4070.

COLOR



Vista trasera / vista delantera

INOXIDABLE ESPEJO V4087
* 140871
83,54€

MEDIDAS (mm)

BOCA BOCACARTAS
325x30 mm

BOCA RECOGECARTAS
330x40 mm

PACKAGING
370x310x145 mm



NEGRO TEXTURADO V4084
* 140840
57,91€



BLANCO V4081
* 140819
57,91€



VERDE V4083
* 140833
57,91€



La correspondencia se introduce por el bocacartas desde el exterior de la puerta y se recoge en el interior mediante el recogecartas.

KANGUR



FICHA TÉCNICA

Capacidad buzón	- ■■■■ +
Resistencia anticorrosiva	■■■■
Material	Acero Galvanizado
Código EAN13	8425181 *

Una solución que facilita la entrega y recepción de paquetes a domicilio, aún cuando el destinatario esté ausente.

Su sistema de boca especial permite depositar el paquete en el interior del buzón con total seguridad.

Sistema de apertura y cierre de la puerta mediante cerradura Eurolock.

Sistema de recepción segura.

ACERO GALVANIZADO



SP005NG
* 727089
101,48€

MEDIDAS (mm)

DIMENSIONES MÁXIMAS DE PAQUETE	



1. La boca del buzón incorpora una bandeja metálica abatible. Al abrir la tapa de boca, la bandeja se coloca en posición horizontal para recibir la paquetería.



2. Al cerrar la tapa de boca, la bandeja metálica va reclinándose y sobre ella el paquete se desliza al interior del buzón.



3 y 4. El paquete queda asegurado en el interior del buzón de manera que sólo puede retirarlo el destinatario abriendo la puerta del buzón.



**PAPELERA
PARA GARAJE**



FICHA TÉCNICA

Material	Acero
Código EAN13	8425181 *

Adecuado para uso en garajes, parkings, inmuebles, etc.

Para facilitar la recogida de los residuos depositados requiere la colocación de una bolsa de plástico en su interior.

Capacidad: 18 L.

EXTRAS

Disponible un pack de 15 bolsas de basura de tamaño adecuado para su uso en las papeleras.

ACERO



BLANCO
E6101



VERDE
E6103



Adecuado para uso en garajes, parkings, inmuebles, etc.



**BOLSAS
DE BASURA**
CR001
* 722879
1,40€

Referencia	E6101	E6103
Medida exterior (Al x An x F)	275x425x155 mm.	275x425x155 mm.
Capacidad	18 L.	18 L.
Código EAN13	* 724286	* 724293
PRECIO	33,06 €	33,06 €

**SEÑALIZACIÓN
CORPÓREA**

FICHA TÉCNICA

Material: Acero inoxidable satinado AISI 304 de 1 mm de espesor.

Letras mayúsculas de la A a la F y números del 0 al 9.

Tipografía única: Arial.

Sistema de fijación: Se fijan a la pared mediante cinta de doble cara o silicona (no suministrada).

3 alturas disponibles: 80 mm, 120 mm y 200 mm

EXTRAS

Cada carácter de la ref. SEC11-T1-S (80 mm) se suministra en un blíster. El resto de referencias se suministran en bolsas.

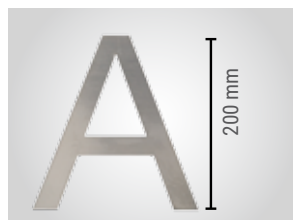

SEC11-T3
9,84 €



SEC11-T2
4,72 €



SEC11-T1
3,02 €

SEC11-T1-S
3,69 €



Letras o números permiten señalar viviendas e inmuebles.

CLÁSICO

4x

FICHA TÉCNICA

Material	Acero lacado
Código EAN13	8425181 *



CUERPO Y REJILLA PLATA
E2302



CUERPO Y REJILLA NEGRA
E2301



CUERPO NEGRO Y REJILLA OCRE
E2303



CUERPO Y REJILLA BLANCO
E2304



CUERPO NEGRO Y REJILLA OCRE
E2313



CUERPO Y REJILLA NEGRA
E2311



CUERPO Y REJILLA PLATA
E2312



CUERPO Y REJILLA BLANCO
E2314

Referencia	E2301	E2302	E2303	E2304	E2311	E2312	E2313	E2314
Medida exterior (Al x An x F)	305x220x190 mm.				305x320x190 mm.			
Código EAN13	* 123010	* 123027	* 123034	* 123041	* 123119	* 123126	* 123133	* 123140
PRECIO	28,96 €	28,96 €	28,96 €	28,96 €	33,57 €	33,57 €	33,57 €	33,57 €

CURVO E2320 / E2330

4x

FICHA TÉCNICA

Material	Acero inoxidable
Código EAN13	8425181 *

Diseño: Líneas curvas.

Práctica: Se coloca en la entrada del edificio y evita la entrada de personas ajenas a la comunidad de vecinos.

Permite la recogida selectiva de publicidad. Total visibilidad del interior.



ACERO INOXIDABLE
E2327



ACERO INOXIDABLE
E2337

Referencia	E2327	E2337
Medida exterior (Al x An x F)	310x220x190 mm.	310x320x190 mm.
Código EAN13	* 123270	* 123379
PRECIO	43,56 €	49,97 €

PANELES DE ANUNCIOS

FICHA TÉCNICA

Material	Cuerpo de aluminio y puerta de metacrilato.
Código EAN13	8425181 *
Incluye imanes de fijación.	
Práctico: Permite fijar en ella notificaciones para la comunidad de vecinos.	

CAPACIDAD
1
DIN-A4



FONDO BLANCO
PAN-51



FONDO PLATA
PAN-52

Referencia	PAN-51	PAN-52
Medida exterior (Al x An x F)	300x400x50 mm.	
Código EAN13	* 100516	* 100523
PRECIO	47,15 €	47,15 €

CAPACIDAD
2
DIN-A4



BLANCO PAN-41



PLATA PAN-42



NEGRO PAN-44



ORO PAN-46

Referencia	PAN-41	PAN-42	PAN-44	PAN-46
Color	Blanco	Plata	Negro	Oro
Medida exterior (Al x An x F)	350x480x50 mm.			
Código EAN13	* 109410	* 100424	* 100448	* 100462
PRECIO	63,04 €	63,04 €	63,04 €	63,04 €

CAPACIDAD
4
DIN-A4



PLATA
PAN-72



LATÓN
PAN-76

Referencia	PAN-72	PAN-76
Color	Plata	Latón
Medida exterior (Al x An x F)	690x550x47 mm.	
Código EAN13	8019635610043	8019635610098
PRECIO	91,23 €	91,23 €

LIMPIADORES PARA BUZONES

FICHA TÉCNICA

Código EAN13

8425181 *

Práctico: Limpian y abrillantan dejando una fina capa repelente de la suciedad y el polvo.

Modo de uso: Pulverizar directamente sobre la superficie a limpiar y frotar con un paño.

Secado instantáneo.



LIM1001



LIM1002

Referencia	LIM1001	LIM1002
TIPO DE BUZÓN	INOXIDABLES	LACADOS
Código EAN13	* 722589	* 722596
PRECIO	3,28 €	3,28 €

PUBLICIDAD NO GRACIAS

FICHA TÉCNICA

Material

Vinilo adhesivo

Código EAN13

8425181 *

Una solución para mantener los buzones libres de publicidad.

Disponible en diferentes idiomas: español, catalán, euskera y gallego.

EXTRAS

Se suministra en blíster con 2 unidades en 2 acabados: fondo negro y letra blanca y fondo blanco y letra negra.

Publicidad
No
Gracias

Mesedez
Publizitaterik
Ez

Publicitat
No
Gracies

Publicidade
Non
Grazas



Referencia	SE801	SE802	SE803	SE804
IDIOMA	ESPAÑOL	EUSKERA	CATALÁ	GALEGO
Código EAN13	* 722534	* 722558	* 722565	* 722572
PRECIO	2,00 €	2,00 €	2,00 €	2,00 €

KIT DE FIJACIÓN PARA VERJAS



FICHA TÉCNICA

Material	Acero
Código EAN13	8425181 *

Permite sujetar los buzones en verjas metálicas.
Fácil instalación.

Ideal para los buzones: Alux, Carpa, Classic, Compact, Costa, Deco, Dime, Espace High line, Figure, Home, Line, Mininova, Nova, Plate, Premium, Premium maxi, Recogecartas, Residencia, Rústico, Urban, Villa, Visit y Zaguán.



C-015
* 715161
6,10€

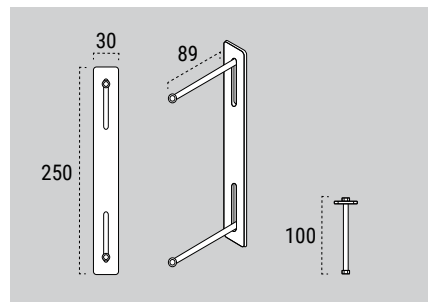

SET DE CERRADURA

FICHA TÉCNICA

Código EAN13	8425181 *
--------------	-----------

CER1001: Apto para los buzones de agrupación con cerradura cromada.

CER1002: Apto para los buzones metálicos de cartero con cerradura cromada.

CER1003: Apto para los buzones de madera con cerradura dorada.

CER1004: Apto para una amplia gama de buzones de exterior, botiquines, armarios y ceniceros.



**SET DE CERRADURA
AGRUPACIÓN
CER1001**
* 810019
6,66€



**SET DE CERRADURA
CARTERO
CER1002**
* 810026
6,66€



**SET DE CERRADURA
MADERA
CER1003**
* 810033
6,92€

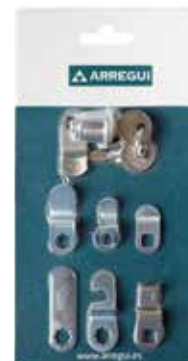

**SET DE CERRADURA
EXTERIOR
CER1004**
* 810040
6,66€

SET DE TARJETEROS DE PLÁSTICO

FICHA TÉCNICA

Código EAN13	8425181 *
--------------	-----------

Contiene 5 tarjeteros de plástico.

Adecuados para los modelos de buzones Arregui.



TJO1001
* 721483
5,02€

REPUESTOS TARJETEROS

REPUESTOS	PRECIO €
TARJETERO DE PLÁSTICO	0,92 €
TARJETERO DE METAL	1,69 €

LLAVES

REPUESTOS	PRECIO €
LLAVES DE BUZONES	SEGÚN MODELO

REPUESTOS CERRADURAS

MODELO BUZON	CERRADURA	LEVA	COLOR	FIJACION	PRECIO	
COSTA	CER02A07CR	-	CROMADA	RÁPIDA	3,02€	
MARE	CER02A07CR	-	CROMADA	RÁPIDA	3,02€	
RECOGECARTAS V4060	CER01A05CR	-	CROMADA	RÁPIDA	3,02€	
RECOGECARTAS V4070	CER01A05CR	-	CROMADA	RÁPIDA	3,02€	
RECOGECARTAS V4090	CER01A05CR	-	CROMADA	RÁPIDA	3,02€	
VILLA	CER01A05CR	-	CROMADA	RÁPIDA	3,02€	

ALUX	CER0070	CER0073L	CROMADA	TUERCA	3,02€	
ARMARIOS DE LLAVES PL	CER0070	CER0076L	CROMADA	TUERCA	3,02€	
ARMARIOS DE LLAVES PLL	CER0070	CER0080L	CROMADA	TUERCA	3,02€	
AURA	CER0070	CER0069L	CROMADA	TUERCA	3,02€	
CASTLE	CER0070	CER0070L	CROMADA	TUERCA	3,02€	
COMPACT	CER0070	CER0070L	CROMADA	TUERCA	3,02€	
DECO	CER0070	CER0070L	CROMADA	TUERCA	3,02€	
DIME	CER0070	CER0070L	CROMADA	TUERCA	3,02€	
FIGURE	CER0070	CER0070L	CROMADA	TUERCA	3,02€	
HOME	CER0070	CER0070L	CROMADA	TUERCA	3,02€	
KANGUR	CER0070	CER0095L	CROMADA	TUERCA	3,02€	
LINE	CER0070	CER0092L	CROMADA	TUERCA	3,02€	
MININOVA	CER0070	CER0091L	CROMADA	TUERCA	3,02€	
PLATE	CER0070	CER0070L	CROMADA	TUERCA	3,02€	
PREMIUM	CER0070	CER0070L	CROMADA	TUERCA	3,02€	
PREMIUM MAXI	CER0070	CER0070L	CROMADA	TUERCA	3,02€	
RESIDENCIA	CER0070	CER0068L	CROMADA	TUERCA	3,02€	
RESIDENCIA MAXI	CER0070	CER0068L	CROMADA	TUERCA	3,02€	
RUSTICO	CER0070	CER0094L	CROMADA	TUERCA	3,02€	
SMART	CER0070	CER0070L	CROMADA	TUERCA	3,02€	
URBAN	CER0070	CER0070L	CROMADA	TUERCA	3,02€	
VISIT	CER0070	CER0070L	CROMADA	RÁPIDA	3,02€	
ZAGUAN	CER0070	CER0070L	CROMADA	TUERCA	3,02€	

CLASSIC	CER0107	-	CROMADA	RÁPIDA	3,02€	
---------	---------	---	---------	--------	-------	---



CAJAS FUERTES

 **ARREGUI**

www.arregui.es

BASA

PARA BASES DE ARMARIO



FICHA TÉCNICA

Protección antitaladro:	-
Llave de emergencia:	✓ (Ref.20000-S7)
Pantalla:	✓ 6 dígitos (Ref.20000-S7)
Códigos apertura:	2 (Ref.20000-S7)
Función máster:	✓ (Ref.20000-S7)
Nº combinaciones	1 millón, de 3 a 6 dígitos (Ref.20000-S7)
Retardo programable	-
Bloqueo	✓ (Ref.20000-S7)
Luz interna	-
Código EAN13	8425181 *
EXTRAS	Adecuada para ocultarla en zócalos de armario.



Ref. 20000-S7K

Ref. 20000-S7

	20000-S7	20000-S7K
Referencia	20000-S7	20000-S7K
Medida exterior (Al x An x F)	110x310x380 mm.	110x310x380 mm.
Medida interior (Al x An x F)	90x305x375 mm.	90x305x375 mm.
Peso	7 kg.	6,3 kg.
Volumen	11 L.	11 L.
Nº bulones	2/∅12 mm.	2/∅12 mm.
Código EAN13	* 718681	* 726921
Medida Packaging (Al x An x F)	160x350x420 mm.	130x330x400 mm.
PRECIO	132,74€	107,63€



La caja Basa es ideal para su ocultación en zócalos de armario.



Su sistema de apertura motorizada hacia arriba permite acceder a su contenido con facilidad.



Oculto en el zócalo de armario la caja Basa pasa desapercibida.

CAJÓN BASA

PARA SUELO



FICHA TÉCNICA

Acabado:	Negro
Anclaje:	Agujeros de fijación en la base y en los laterales.
Advertencia:	Para su uso exclusivo con la caja fuerte Basa.
Instalación:	El cajón debe instalarse de manera que la tapa quede nivelada con el suelo. Puede ocultarse bajo una alfombra o mueble auxiliar.
Código EAN13	8425181 *

EXTRAS

- Permite instalar la caja fuerte Basa oculta en el suelo.
- La tapa camufla la caja fuerte protegiéndola y permitiendo pisar sobre ella sin dañarla.



Ref. 20000-S7C

Referencia	20000-S7C
Medida exterior (Al x An x F)	125x316x386 mm.
Medida interior (Al x An x F)	110x310x380 mm.
Peso	4 kg.
Volumen	13 L.
Nº bulones	-
Código EAN13	* 721254
Medida Packaging (Al x An x F)	146x340x410 mm.
PRECIO	44,59€



El cajón metálico dispone de agujeros para su fijación al suelo y a la caja fuerte.



La tapa metálica camufla la caja fuerte protegiéndola y permitiendo pisar sobre ella.



El cajón permite instalar la caja fuerte en el suelo y ocultarla bajo una alfombra o mueble auxiliar.



GRID

EMPOTRADA EN PARED TRAS REJILLA



FICHA TÉCNICA

Acabado:	Negro
Instalación:	La caja debe instalarse de forma que la rejilla simule estar atornillada a la pared.
Apertura:	Mediante llave de puntos.
Código EAN13	8425181 * *
Diseñada para su instalación empotrada en la pared y camuflada detrás de la rejilla de ventilación que lleva incorporada en su frontal. Requiere obra para su instalación.	



Ref. 13000W-S0



Ref. 13000W-S1



APERTURA	LLAVE	LLAVE
Referencia	13000W-S0	13000W-S1
Medida exterior (Al x An x F)	200x200x130 mm.	200x400x130 mm.
Medida interior (Al x An x F)	198x170x127 mm.	198x370x127 mm.
Peso	4,5 kg.	7,5 kg.
Volumen	6 L.	12 L.
Código EAN13	* 721568	* 726884
Medida Packaging (Al x An x F)	210x210x170 mm.	210x410x170 mm.
PRECIO	84,05€	99,94€



Retirando la rejilla de seguridad accedemos a la cerradura de la caja.



Dispone de capacidad para guardar pequeños objetos de valor.



Sistema de apertura mediante llave de puntos.



Puede ser ocultado en cualquier rincón de la vivienda o inmueble.

SOCKET

EMPOTRADA EN PARED TRAS ENCHUFES



FICHA TÉCNICA

Acabado:	Negro
Instalación:	La caja debe instalarse de forma que la placa de enchufes quede enrasada con la pared. Los enchufes se fijan mediante imanes.
Apertura:	Mediante llave de puntos.
Código EAN13	8425181 *
Diseñada para su instalación empotrada en la pared y camuflada detrás de la placa de enchufes que lleva incorporada en su frontal. Requiere obra para su instalación.	



Ref. 23000W-S2



Ref. 23000W-S1

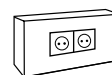
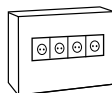

APERTURA	LLAVE	LLAVE
Referencia	23000W-S2	23000W-S1
Medida exterior (Al x An x F)	350x400x130 mm.	200x400x130 mm.
Medida interior (Al x An x F)	348x370x127 mm.	198x370x127 mm.
Peso	10 kg.	7,5 kg.
Volumen	15 L.	12 L.
Código EAN13	* 728147	* 728130
Medida Packaging (Al x An x F)	360x410x150 mm.	210x410x150 mm.
PRECIO	138,38€	100,45€



Retirando los enchufes accedemos a la cerradura de la caja.



Sistema de apertura mediante llave de puntos.



Puede ser ocultado en cualquier rincón de la vivienda o inmueble.



BOX-IN

PARA ZÓCALOS DE COCINA

FICHA TÉCNICA

Acabado:	Negro
Anclaje:	Incorpora un sistema de fijación especial.
Apertura:	Sistema de apertura mediante cerradura con llave de puntos.
Código EAN13	8425181 *
EXTRAS Dispone de un sistema de fijación desde la base del armario, cómodo de instalar y muy seguro.	



Ref. 22000-S1



Ref. 22100-S1

APERTURA	LLAVE	LLAVE
Referencia	22000-S1	22100-S1
Medida exterior (Al x An x F)	98x410x450 mm.	148x410x450 mm.
Medida interior (Al x An x F)	85x378x380 mm.	135x378x380 mm.
Peso	8,5 kg.	10 kg.
Volumen	12 L.	19 L.
Nº bulones	1 de 200x20 mm.	1 de 200x20 mm.
Posición bulones		
Código EAN13	* 726938	* 726945
Medida Packaging (Al x An x F)	100x420x470 mm.	150x420x470 mm.
PRECIO	145,55€	166,05€



Sistema de apertura mediante cerradura con llave de puntos.



La caja dispone de un bulón plano de 200x20mm.



Sistema de fijación desde la base del armario, cómodo de instalar y muy seguro.



Formato adecuado para camuflarlo detrás del zócalo de cocina.

COVER



FICHA TÉCNICA

Protección antitaladro:	-
Tipo de cerradura	Gorjas
Llave de emergencia:	✓
Pantalla:	✓ 6 dígitos
Códigos apertura:	2
Función máster:	✓
Nº combinaciones	1 millón, de 3 a 6 dígitos
Retardo programable	-
Bloqueo	✓
Luz interna	✓
Código EAN13	8425181 *
EXTRAS	Adecuada para ocultarla en el falso fondo de un armario.

PARA FONDO DE ARMARIO

NEW



Ref.172060

Referencia	172060
Medida exterior (Al x An x F)	350x350x150 mm.
Medida interior (Al x An x F)	346x346x90 mm.
Peso	10 kg.
Volumen	11 L.
Nº bulones	2/ø20 mm.
Código EAN13	* 733370
Medida Packaging (Al x An x F)	370x370x170 mm.
PRECIO	120,44€



La caja Cover es ideal para su ocultación en fondos de armario.

PREMIER

ESPESOR FRENTE

3
mm.



NEW

FICHA TÉCNICA

Protección antitaladro:	-
Tipo de cerradura:	Electrónica + pomo
Llave de emergencia:	✓
Códigos apertura:	1
Función máster:	-
Pantalla:	-
Nº combinaciones	100 millones, de 3 a 8 dígitos
Retardo programable	-
Bloqueo	✓
Luz interna	-
Código EAN13	8425181 *



PREMIER
Ref. 16501-S2

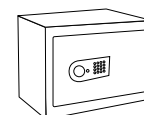
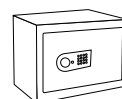
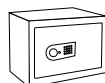

APERTURA	ELECTRÓNICA +POMO	ELECTRÓNICA +POMO	ELECTRÓNICA +POMO
Referencia	16501-S0	16501-S1	16501-S2
Medida exterior (Al x An x F)	170x230x170 mm.	200x310x200 mm.	250x350x250 mm.
Medida interior (Al x An x F)	165x225x115 mm.	195x305x145 mm.	245x345x195 mm.
Peso	3,7kg.	5kg.	6,8kg.
Volumen	4 L.	9 L.	16 L.
Espesor (frente / cuerpo)	3 mm. / 1,5 mm.	3 mm. / 1,5 mm.	3 mm. / 1,5 mm.
Bandeja	-	-	-
Nº bulones	2/Ø16 mm.	2/Ø16 mm.	2/Ø20 mm.
Posición bulones			
Código EAN13	* 734391	* 734407	* 731598
Medida Packaging (Al x An x F)	190x250x190 mm.	225x335x220 mm.	270x370x270 mm.
PRECIO	42,03€	50,23€	65,60€



Dos bulones a distintas alturas aseguran la puerta.



Dispone de llave de emergencia para su uso en caso de olvido del código secreto.





NEW STYLO

ESPESOR FRENTE

4 mm.



NEW

FICHA TÉCNICA

Protección antitaladro:	-
Tipo de cerradura:	De Puntos
Llave de emergencia:	✓
Códigos apertura:	2
Función máster:	✓
Pantalla:	-
Nº combinaciones	100 millones, de 3 a 8 dígitos
Retardo programable	-
Bloqueo	✓
Luz interna	-
Código EAN13	8425181 *



NEW STYLO
Ref. 19010-S1

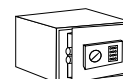
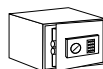

APERTURA	ELECTRÓNICA + LLAVE	ELECTRÓNICA + LLAVE
Referencia	19010-S1	19010-S2
Medida exterior (Al x An x F)	200x310x200 mm.	250x350x250 mm.
Medida interior (Al x An x F)	195x305x135 mm.	245x345x180 mm.
Peso	7kg.	9,5 kg.
Volumen	8 L.	15 L.
Espesor (frente/cuerpo)	4 mm. / 2 mm.	4 mm. / 2 mm.
Bandeja	-	-
Nº bulones	2/Ø16 mm.	2/Ø20 mm.
Posición bulones		
Código EAN13	* 731628	* 731635
Medida Packaging (Al x An x F)	220x330x240 mm.	270x370x290 mm.
PRECIO	65,60€	80,98€



Dos bulones a distintas alturas aseguran la puerta.



Dispone de llave de emergencia tubular para su uso en caso de olvido del código secreto.



CLASS LLAVE

ESPESOR FRENTE

3 mm.

TL

FICHA TÉCNICA

Protección antitaladro:	-
Tipo de cerradura:	Gorjas
Llave de emergencia:	-
Códigos apertura:	-
Función máster:	-
Pantalla:	-
Nº combinaciones	-
Retardo programable	-
Bloqueo	-
Luz interna	-
Código EAN13	8425181 *



CLASS
Ref. T-25K

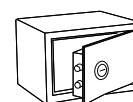
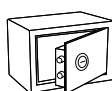

APERTURA	LLAVE	LLAVE
Referencia	T-17K	T-25K
Medida exterior (Al x An x F)	170x230x170 mm.	250x350x250 mm.
Medida interior (Al x An x F)	165x225x110 mm.	240x340x200 mm.
Peso	3kg.	7kg.
Volumen	4 L.	17 L.
Espesor (frente / cuerpo)	3 mm. / 1,5 mm.	3 mm. / 1,5 mm.
Bandeja	-	-
Nº bulones	2/Ø20 mm.	2/Ø20 mm.
Posición bulones		
Código EAN13	* 726594	* 225776
Medida Packaging (Al x An x F)	190x255x190 mm.	270x370x265 mm.
PRECIO	42,03€	65,60€



Ref. T17K



Cerradura de gorjas de doble paletón.

CLASS ELECTRÓNICA

ESPESOR FRENTE

3 mm.



FICHA TÉCNICA

Protección antitaladro:	-
Tipo de cerradura:	Electrónica con pomo
Llave de emergencia:	✓
Códigos apertura:	1
Función máster:	-
Pantalla:	-
Nº combinaciones	100 millones, de 4 a 8 dígitos
Retardo programable	-
Bloqueo	✓
Luz interna	-
Código EAN13	8425181 *

- Disponen de botón de programación interior.
- **T-35EB** es adecuada para guardar portátiles de hasta 15".



CLASS
Ref. T-20EB

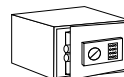

APERTURA	ELECTRÓNICA + POMO	ELECTRÓNICA + POMO	ELECTRÓNICA + POMO
Referencia	T-20EB	T-25EB	T-35EB
Medida exterior (Al x An x F)	200x310x200 mm.	250x350x250 mm.	200x430x350 mm.
Medida interior (Al x An x F)	190x300x150 mm.	240x340x200 mm.	190x420x300 mm.
Peso	5kg.	7kg.	12kg.
Volumen	9 L.	17 L.	24 L.
Espesor (frente / cuerpo)	3 mm. / 1,5 mm.	3 mm. / 1,5 mm.	3 mm. / 1,5 mm.
Bandeja	-	-	-
Nº bulones	2/Ø18 mm.	2/Ø18 mm.	2/Ø18 mm.
Posición bulones			
Código EAN13	* 220887	* 225882	* 235881
Medida Packaging (Al x An x F)	220x330x240 mm.	270x370x290 mm.	220x450x370 mm.
PRECIO	52,28€	67,65€	91,23€



Ref. T-20EB



Ref. T-35EB: adecuada para portátiles de hasta 15".

SUPRA

ESPESOR FRENTE

6 mm.

TL

NEW

FICHA TÉCNICA

Protección antitaladro:	-
Tipo de cerradura	Gorjas
Llave de emergencia:	✓
Pantalla:	✓ 6 dígitos
Códigos apertura:	2
Función máster:	✓
Nº combinaciones	1 millón, de 3 a 6 dígitos
Retardo programable	-
Bloqueo	✓
Luz interna	✓
Código EAN13	8425181 *



SUPRA
Ref. 240020

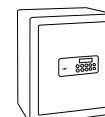
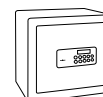

APERTURA	ELECTRÓNICA + LLAVE	ELECTRÓNICA + LLAVE	ELECTRÓNICA + LLAVE	ELECTRÓNICA + LLAVE
Referencia	240010	240020	240060	240080
Medida exterior (Al x An x F)	200x310x200 mm.	250x350x250 mm.	380x350x360 mm.	520x350x360 mm.
Medida interior (Al x An x F)	195x305x140 mm.	245x345x190 mm.	375x345x300 mm.	515x345x300 mm.
Peso	7,5 kg.	10,5 kg.	17 kg.	21,5 kg.
Volumen	8 L.	16 L.	39 L.	53 L.
Espesor (frente / cuerpo)	6 mm. / 2 mm.	6 mm. / 2 mm.	6 mm. / 2 mm.	6 mm. / 2 mm.
Bandeja	x	x	1	1
Nº bulones	2/ø20 mm.	2/ø20 mm.	2/ø20 mm.	3/ø20 mm.
Posición bulones				
Código EAN13	* 733332	* 731741	* 731765	* 731659
Medida Packaging (Al x An x F)	270x370x270 mm.	270x370x270 mm.	400x370x380 mm.	540x370x380 mm.
PRECIO	97,38€	112,75€	143,50€	184,50€



Ref. SUPRA 240080.



Atractivo diseño interior, con colores vivos.



Bulones giratorios y guiados, que impiden su corte desde el exterior



SUPRA MOTORIZADA

ESPESOR FRENTE

6 mm.



SUPRA
Ref. 240220



FICHA TÉCNICA

Protección antitaladro:	-
Llave de emergencia:	✓
Pantalla:	✓ 6 dígitos
Códigos apertura:	2
Función máster:	✓
Nº combinaciones	1 millón, de 3 a 6 dígitos
Retardo programable	-
Bloqueo	✓
Luz interna	✓
Código EAN13	8425181 *

APERTURA	MOTORIZADA
Referencia	240220
Medida exterior (Al x An x F)	250x350x250 mm.
Medida interior (Al x An x F)	245x345x190 mm.
Peso	10,5 kg.
Volumen	16 L.
Espesor (frente / cuerpo)	6 mm. / 2 mm.
Bandeja	x
Nº bulones	2/∅20 mm.
Posición bulones	
Código EAN13	* 732670
Medida Packaging (Al x An x F)	270x370x270 mm.
PRECIO	112,75€



Dispone de llave de emergencia para su apertura en caso de olvido del código o si se agotan las pilas

NEW

FORMA EVOLUTION

ESPESOR FRENTE

6+3 mm.
Acero antitaladro



FICHA TÉCNICA

Protección antitaladro:	✓
Tipo de cerradura	Gorjas
Llave de emergencia:	✓
Pantalla:	✓ 8 dígitos
Códigos apertura:	2
Función máster:	✓
Nº combinaciones	100 millones, de 3 a 8 dígitos
Retardo programable	-
Bloqueo	✓
Luz interna	✓
Código EAN13	8425181 *



FORMA EVOLUTION
Ref. 150050

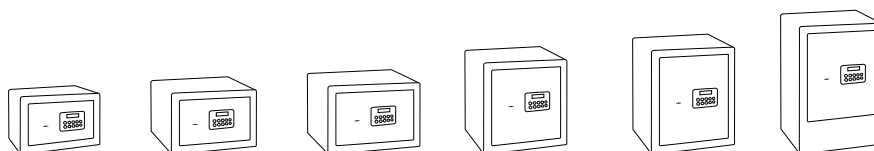

APERTURA	ELECTR. + LLAVE	ELECTR. + LLAVE	ELECTR. + LLAVE	ELECTR. + LLAVE	ELECTR. + LLAVE	ELECTR. + LLAVE
Referencia	150020	150040	150050	150070	150080	150090
Medida ext. (AlxAnxF) mm.	250x350x250	270x385x300	320x420x360	420x385x360	520x385x360	620x385x360
Medida int. (AlxAnxF) mm.	244x344x195	264x379x245	314x414x305	414x379x305	514x379x305	614x379x305
Peso	17,7 kg.	23,2 kg.	29,6 kg.	33,5 kg.	38,8 kg.	45,5 kg.
Volumen	16 L.	25 L.	40 L.	48 L.	59 L.	71 L.
Espesor (frente/cuerpo)	6+3 mm. / 3 mm.	6+3 mm. / 3 mm.	6+3 mm. / 3 mm.	6+3 mm. / 3 mm.	6+3 mm. / 3 mm.	6+3 mm. / 3 mm.
Bandeja	1	1	1	1	1	1
Nº bulones	2/ø22 mm.	6/ø22 mm.	7/ø22 mm.	7/ø22 mm.	7/ø22 mm.	7/ø22 mm.
Posición bulones						
Código EAN13	* 733585	* 733592	* 733608	* 733615	* 733622	* 733639
Medida Packaging (Al x An x F) mm.	265x370x300	285x405x350	335x440x410	435x405x410	535x405x410	635x405x410
PRECIO	199,88€	215,25€	246,00€	276,75€	307,50€	338,25€



Toma de corriente externa tipo micro USB.



Bulones guiados por soportes macizos y alojamiento interno para bulones.



FORMA EVOLUTION CON RANURA

ESPESOR FRENTE

6+3 mm.
Acero antitaladro

NEW



FICHA TÉCNICA

Protección antitaladro:	✓
Tipo de cerradura	Gorjas
Llave de emergencia:	✓
Pantalla:	✓ 8 dígitos
Códigos apertura:	2
Función máster:	✓
Nº combinaciones	100 millones, de 3 a 8 dígitos
Retardo programable	-
Bloqueo	✓
Luz interna	✓
Código EAN13	8425181 *

EXTRAS
Dispone de ranura de 162x15 mm para introducir documentos o billetes sin necesidad de abrir la caja.



FORMA EVOLUTION
Ref. 150040-SL



APERTURA	ELECTR. + LLAVE + RANURA	ELECTR. + LLAVE + RANURA
Referencia	150040-SL	150080-SL
Medida ext. (AlxAxF) mm.	300x385x300	550x385x360
Medida int. (AlxAxF) mm.	294x379x245	544x379x305
Peso	24,1 kg.	39,3 kg.
Volumen	27 L.	63 L.
Espesor (frente/cuerpo)	6+3 mm. / 3 mm.	6+3 mm. / 3 mm.
Bandeja	x	x
Nº bulones	6/ø22mm	7/ø22 mm.
Posición bulones		
Código EAN13	* 734179	* 734551
Medida Packaging (Al x An x F)	315x405x350 mm.	565x405x410 mm.
PRECIO	235,75€	328,00€

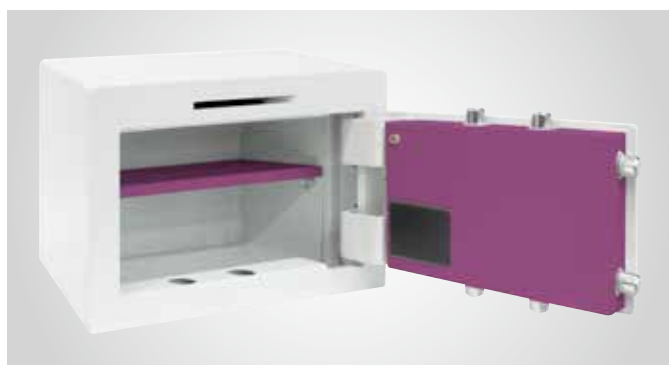

Bulones guiados por soportes macizos y alojamiento interno para bulones.



Ref. 150080-SL

FORMA C

ESPESOR FRENTE
6
mm.



Certificada por blindaje especial antitaladro



FICHA TÉCNICA

Protección antitaladro:	✓
Tipo de cerradura	Gorjas
Llave de emergencia:	✓
Pantalla:	-
Códigos apertura:	2
Función máster:	✓
Nº combinaciones	1 billón, de 1 a 12 dígitos
Retardo programable	-
Bloqueo	✓
Luz interna	-
Código EAN13	8425181 * *

EXTRAS

- Cuerpo y frente con blindaje especial anti-taladro. Maximiza la protección de su contenido frente a posibles ataques externos.
- Bulones giratorios de 22 mm de diámetro guiados por soportes macizos de 15 mm.
- Ángulo de apertura regulable de 90° a 110°.
- Bocallave integrado: El rebaje en la bocallave facilita la inserción de la llave.
- Bloqueo del sistema tras 5 introducciones incorrectas del código de acceso.



FORMA C
Ref. 15010



APERTURA	ELECTR. + LLAVE	ELECTR. + LLAVE	ELECTR. + LLAVE	ELECTR. + LLAVE
Referencia	15000C	15010C	15020C	15040C
Medida ext. (AlxAnxF) mm.	270x385x300	320x420x360	420x385x360	520x385x360
Medida int. (AlxAnxF) mm.	255x375x240	305x410x290	405x375x290	505x375x290
Peso	20,5 kg.	26,5 kg.	30,5 kg.	36,5 kg.
Volumen	23 L.	36 L.	44 L.	55 L.
Espesor (frente/cuerpo)	6 mm. / 3 mm.	6 mm. / 3 mm.	6 mm. / 3 mm.	6 mm. / 3 mm.
Bandeja	1	1	1	1
Nº bulones	6/ø22 mm.	7/ø22 mm.	7/ø22mm	7/ø22 mm.
Posición bulones				
Código EAN13	* 726136	* 726143	* 726150	* 726167
Medida Packaging (Al x An x F)	310x425x350 mm.	360x460x405 mm.	460x400x425 mm.	550x425x410 mm.
PRECIO	225,50€	261,38€	297,25€	333,13€



Bulones giratorios de 22 mm de diámetro guiados por soportes macizos de 15 mm.



Bloqueo del sistema tras 5 introducciones incorrectas del código de acceso.



Certificada por blindaje especial antitaladro



FORMA C

ESPESOR FRENTE

6 mm.



Certificada por blindaje especial antitaladro



FORMA C Ref. 15040C

PEANA FORMA C

FICHA TÉCNICA

Permite elevar la caja del suelo de manera que permite instalar la caja fuerte en armarios con zócalo.

Anclaje:
Incluye agujeros para su fijación al suelo o pared y a la caja fuerte.

Código EAN13

8425181 *

EXTRAS

• Adecuado para los modelos 15000C y 15010C.



PEANA Ref. 15000C

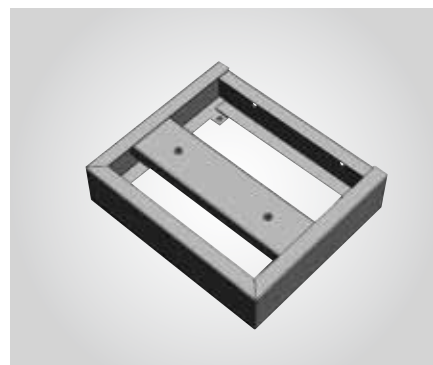

COMPLEMENTO	PEANA	PEANA
Referencia	P15000C	P15010C
Medida ext. (AlxAnxF) mm.	100x377x282	100x412x342
Peso	3,7 kg.	4,2 kg.
Código EAN13	* 726808	* 726822
PRECIO	30,75€	33,83€

CAJAS FUERTES SOBREPONER



www.arregui.es

PLUS-C

ESPESOR FRENTE
10+3 mm.
Acero antitaladro



Clasificada en **Grado S2** por el laboratorio **APPLUS** según Norma **UNE EN 14450:2007**, con informe de ensayo 14/9221-1597

NEW

FICHA TÉCNICA

Protección antitaladro:	✓
Tipo de cerradura	Gorjas Certificada EN1300 CLASE A
Llave de emergencia:	-
Pantalla:	✓ 8 dígitos
Códigos apertura:	2
Función máster:	✓
Nº combinaciones	100 millones, de 3 a 8 dígitos
Retardo programable	✓
Bloqueo	✓
Luz interna	✓
Código EAN13	8425181 *



PLUS-C
Ref. 180050

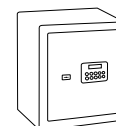
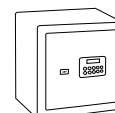

APERTURA	ELECTRÓNICA + LLAVE	ELECTRÓNICA + LLAVE	ELECTRÓNICA + LLAVE	ELECTRÓNICA + LLAVE
Referencia	180040	180050	180070	180080
Medida exterior (Al x An x F)	270x385x300 mm.	320x420x360 mm.	420x385x360 mm.	520x385x360 mm.
Medida interior (Al x An x F)	260x375x239 mm.	310x410x299 mm.	410x375x299 mm.	510x375x299 mm.
Peso	32,7 kg.	37 kg.	48,5 kg.	56,6 kg.
Volumen	23 L.	38 L.	46 L.	57 L.
Espesor (frente / cuerpo)	10+3 mm. / 5 mm.	10+3 mm. / 5 mm.	10+3 mm. / 5 mm.	10+3 mm. / 5 mm.
Bandeja	1	1	1	1
Nº bulones	6/ø22 mm.	7/ø22 mm.	7/ø22 mm.	7/ø22 mm.
Posición bulones				
Código EAN13	* 733394	* 733400	* 733417	* 733424
Medida Packaging (Al x An x F) mm.	285x405x350	335x440x410	435x405x410	535x405x410
PRECIO	302,38€	348,50€	394,63€	440,75€



Con alojamiento para bulones.



Toma de corriente externa tipo micro USB.



Bulones giratorios y guiados, que impiden su corte desde el exterior



PLUS-C

ESPESOR FRENTE

10+3 mm.
Acero antitaladro



Clasificada en **Grado S2** por el laboratorio **APPLUS** según Norma **UNE EN 14450:2007**, con informe de ensayo 14/9221-1597

NEW

FICHA TÉCNICA

Protección antitaladro:	✓
Tipo de cerradura	Gorjas Certificada EN1300 CLASE A
Llave de emergencia:	-
Pantalla:	-
Códigos apertura:	-
Función máster:	-
Nº combinaciones	-
Retardo programable	-
Bloqueo	-
Luz interna	-
Código EAN13	8425181 *



PLUS-C
Ref.180350

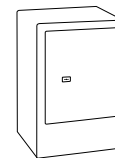
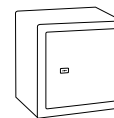
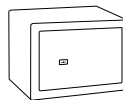
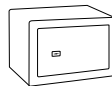
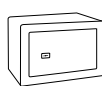

APERTURA	LLAVE	LLAVE	LLAVE	LLAVE	LLAVE
Referencia	180310	180320	180340	180350	180390
Medida exterior (Al x An x F)	200x310x200 mm.	250x350x250 mm.	270x385x300 mm.	320x420x360 mm.	620x385x360 mm.
Medida interior (Al x An x F)	190x300x139 mm.	240x340x189 mm.	260x375x239 mm.	310x410x299 mm.	610x375x299 mm.
Peso	18 kg.	23 kg.	28,5 kg.	38 kg.	50 kg.
Volumen	8 L.	15 L.	23 L.	38 L.	68 L.
Espesor (frente / cuerpo)	10+3 mm. / 5 mm.	10+3 mm. / 5 mm.	10+3 mm. / 5 mm.	10+3 mm. / 5 mm.	10+3 mm. / 5 mm.
Bandeja	-	1	1	1	1
Nº bulones	2/ø22 mm.	2/ø22 mm.	6/ø22 mm.	7/ø22 mm.	7/ø22 mm.
Posición bulones					
Código EAN13	* 734582	* 733578	* 733479	* 733486	* 734599
Medida Packaging (Al x An x F) mm.	215x330x250	265x370x300	285x405x350	335x440x410	635x405x410
PRECIO	189,63€	220,38€	251,13€	297,25€	435,63€



Cerradura certificada EN1300 Clase A.



Bulones giratorios y guiados, que impiden su corte desde el exterior



PLUS-C CON RANURA

ESPESOR FRENTE

10+3 mm.
Acero antitaladro



Cerradura Certificada EN1300 CLASE A

NEW

FICHA TÉCNICA

Protección antitaladro:	✓
Tipo de cerradura	Gorjas Certificada EN1300 CLASE A
Llave de emergencia:	-
Pantalla:	✓ 8 dígitos
Códigos apertura:	2
Función máster:	✓
Nº combinaciones	100 millones, de 3 a 8 dígitos
Retardo programable	✓
Bloqueo	✓
Luz interna	✓
Código EAN13	8425181 *
EXTRAS Dispone de ranura de 162x15 mm para introducir documentos o billetes sin necesidad de abrir la caja.	



PLUS-C
Ref.180050-SL



APERTURA	ELECTRÓNICA + LLAVE + RANURA
Referencia	180050-SL
Medida exterior (Al x An x F)	350x420x360 mm.
Medida interior (Al x An x F)	340x410x299 mm.
Peso	44,4 kg.
Volumen	42 L.
Espesor (frente / cuerpo)	10+3 mm. / 5 mm.
Bandeja	x
Nº bulones	7/ø22 mm.
Posición bulones	
Código EAN13	* 734575
Medida Packaging (Al x An x F) mm.	365x440x410
PRECIO	369,00€

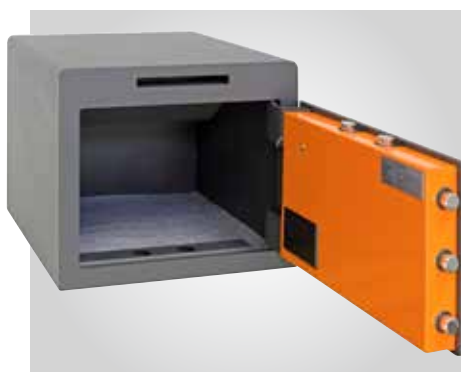

Bulones giratorios y guiados que impiden su corte desde el exterior. Alojamiento interno para bulones.



Dispone de luz interna.



Ranura de 162x15 mm para introducir documentos o billetes sin necesidad de abrir la caja.

FORZA

ESPESOR FRENTE

70 mm.



FICHA TÉCNICA

Protección antitaladro:	✓
Tipo de cerradura:	Electrónica Certificada EN1300 CLASE A
Llave de emergencia:	-
Pantalla:	-
Códigos apertura:	2
Función máster:	✓
Nº combinaciones	1 millón, de 6 a 8 dígitos
Retardo programable	✓
Bloqueo	✓
Luz interna	-
Código EAN13	8425181 *

EXTRAS

- Cierre perimetral, con bulones en 3 lados y placas fijas que entran en el cuerpo.
- Alojamiento interno para los bulones que aseguran la puerta.
- Toma de corriente externa, con aplicación directa de pila de 9 V.



Clase S2, según Norma Europea EN14450



FORZA
Ref.42270

APERTURA	ELECTRÓNICA + POMO
Referencia	42270
Medida exterior (Al x An x F)	1000x445x400 mm.
Medida interior (Al x An x F)	920x365x296 mm.
Peso	65 kg.
Volumen	99 L.
Espesor (frente / cuerpo)	70 mm. / 40 mm.
Bandeja	2
Nº bulones	6/∅19 mm.
Posición bulones	
Código EAN13	* 727997
Medida Packaging (Al x An x F) mm.	1035x455x520
PRECIO	814,88€



Cierre perimetral, con bulones en 3 lados.



Bandeja interior regulable en altura.



Certificada S2 según Norma Europea EN 14450

PREMIER

ESPESOR FRENTE

3 mm.



FICHA TÉCNICA

Protección antitaladro:	-
Tipo de cerradura:	Electrónica + pomo
Llave de emergencia:	✓
Pantalla:	-
Códigos apertura:	1
Función máster:	-
Nº combinaciones	100 millones, de 3 a 8 dígitos
Retardo programable	-
Bloqueo	✓
Luz interna	-
Código EAN13	8425181 *

NEW



PREMIER
Ref. 16501W-S0

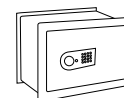
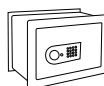

APERTURA	ELECTRÓNICA +POMO	ELECTRÓNICA +POMO
Referencia	16501W-S0	16501W-S1
Medida exterior (Al x An x F)	190x250x150 mm.	210x320x200 mm.
Medida interior (Al x An x F)	165x225x90 mm.	185x295x140 mm.
Peso	3,7 kg.	5 kg.
Volumen	4 L.	8 L.
Espesor (frente / cuerpo)	3 mm. / 1,2 mm.	3 mm. / 1,2 mm.
Bandeja	x	x
Nº bulones	2/Ø16 mm	2/Ø16 mm
Posición bulones		
Código EAN13	* 731604	* 731611
Medida Packaging (Al x An x F)	210x270x170 mm.	230x340x220 mm.
PRECIO	55,35€	70,73€



Dispone de llave de emergencia para su uso en caso de olvido del código de apertura.



Dos bulones a distintas alturas aseguran la puerta.

NEW STYLO

ESPESOR FRENTE

4 mm.



NEW

FICHA TÉCNICA

Protección antitaladro:	-
Tipo de cerradura:	Puntos
Llave de emergencia:	✓
Pantalla:	-
Códigos apertura:	2
Función máster:	✓
Nº combinaciones	100 millones, de 3 a 8 dígitos
Retardo programable	-
Bloqueo	✓
Luz interna	-
Código EAN13	8425181 *



NEW STYLO
Ref. 19010W-S1

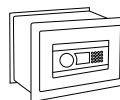

APERTURA	ELECTRÓNICA + LLAVE
Referencia	19010W-S1
Medida exterior (Al x An x F)	210x320x200 mm.
Medida interior (Al x An x F)	185x295x135 mm.
Peso	7,2 kg.
Volumen	8 L.
Espesor (frente/cuerpo)	4 mm. / 2 mm.
Bandeja	x
Nº bulones	2/Ø16 mm.
Posición bulones	
Código EAN13	* 731642
Medida Packaging (Al x An x F)	230x340x240 mm.
PRECIO	70,73€



Dispone de llave de emergencia tubular para su uso en caso de olvido del código secreto.



Dos bulones a distintas alturas aseguran la puerta.

CLASS ELECTRÓNICA

ESPESOR FRENTE

3
mm.



FICHA TÉCNICA

Protección antitaladro:	-
Tipo de cerradura:	Electrónica + pomo
Llave de emergencia:	✓
Pantalla:	-
Códigos apertura:	1
Función máster:	-
Nº combinaciones	100 millones, de 4 a 8 dígitos
Retardo programable	-
Bloqueo	✓
Luz interna	-
Código EAN13	8425181 *
Programación:	Dispone de botón de programación interior.



CLASS
Ref. W-25EB

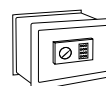

APERTURA	ELECTRÓNICA + POMO
Referencia	W-25EB
Medida exterior (Al x An x F)	280x380x250 mm.
Medida interior (Al x An x F)	240x340x200 mm.
Peso	13 kg.
Volumen	17 L.
Espesor (frente / cuerpo)	3 mm. / 1,5 mm.
Bandeja	x
Nº bulones	2/Ø18 mm.
Posición bulones	
Código EAN13	* 325889
Medida Packaging (Al x An x F)	290x390x280 mm.
PRECIO	79,95€



Marco reforzado de 8 mm de espesor.



Dispone de llave de emergencia.

IDEAL 5

ESPESOR FRENTE

5 mm.

NEW



FICHA TÉCNICA

Protección antitaladro:	-
Tipo de cerradura:	Gorjas
Llave de emergencia:	-
Pantalla:	-
Códigos apertura:	-
Función máster:	-
Nº combinaciones	-
Retardo programable	-
Bloqueo	-
Luz interna	-
Código EAN13	8425181 *



IDEAL 5
Ref. 271310

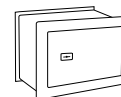
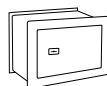

APERTURA	LLAVE	LLAVE
Referencia	271310	271320
Medida exterior (Al x An x F)	200x300x200 mm.	230x350x200 mm.
Medida interior (Al x An x F)	175x270x160 mm.	205x320x160 mm.
Peso	8,9 kg.	10,5 kg.
Volumen	8 L.	10 L.
Espesor (frente / cuerpo)	5 mm. / 2 mm.	5 mm. / 2 mm.
Bandeja	1	1
Nº bulones	2/Ø18 mm	2/Ø18 mm
Posición bulones		
Código EAN13	* 734520	* 734537
Medida Packaging (Al x An x F)	220x315x220 mm.	250x365x220 mm.
PRECIO	55,35€	70,73€



Dos bulones a distintas alturas aseguran la puerta.



Dispone de bandeja interior.

SUPRA

ESPESOR FRENTE

6
mm.

FONDO REGULABLE

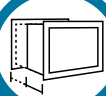

TL

NEW

FICHA TÉCNICA

Protección antitaladro:	-
Tipo de cerradura	Gorjas
Llave de emergencia:	✓
Pantalla:	✓ 6 dígitos
Códigos apertura:	2
Función máster:	✓
Nº combinaciones	1 millón, de 3 a 6 dígitos
Retardo programable	-
Bloqueo	✓
Luz interna	✓
Código EAN13	8425181 *
EXTRAS	
Fondo regulable a 5 posiciones cada 25 mm (150 / 175 / 200 / 225 / 250 mm).	



SUPRA
Ref. 241020

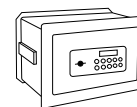
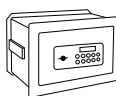

APERTURA	ELECTRÓNICA + LLAVE	ELECTRÓNICA + LLAVE
Referencia	241020	241060
Medida exterior (Al x An x F)	260x360x150/250 mm.	390x360x150/250 mm.
Medida interior (Al x An x F)	240x340x90/190 mm.	370x340x90/190 mm.
Peso	11,5 kg.	16,3 kg.
Volumen	7-16 L.	11-24 L.
Espesor (frente / cuerpo)	6 mm. / 2 mm.	6 mm. / 2 mm.
Bandeja	x	x
Nº bulones	2/ø20 mm.	2/ø20 mm.
Posición bulones		
Código EAN13	* 731758	* 734193
Medida Packaging (Al x An x F)	280x380x170 mm.	410x380x170 mm.
PRECIO	117,88€	148,63€



Máxima apertura de la puerta para un óptimo aprovechamiento interior.



Fondo regulable, 5 posiciones cada 25 mm.



Bulones giratorios y guiados, que impiden su corte desde el exterior.

FORMA EVOLUTION

ESPESOR FRENTE FONDO REGULABLE

6+3 mm.
Acero antitaladro

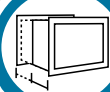

NEW



FICHA TÉCNICA

Protección antitaladro:	-
Tipo de cerradura	Gorjas
Llave de emergencia:	✓
Pantalla:	✓ 8 dígitos
Códigos apertura:	2
Función máster:	✓
Nº combinaciones	100 millones, de 3 a 8 dígitos
Retardo programable	-
Bloqueo	✓
Luz interna	✓
Código EAN13	8425181 * *

EXTRAS

Fondo regulable a 5 posiciones cada 25 mm (200/225/250/275/300 mm).



FORMA EVOLUTION
Ref. 151050

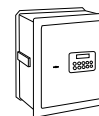
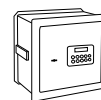

APERTURA	ELECTR. + LLAVE	ELECTR. + LLAVE	ELECTR. + LLAVE	ELECTR. + LLAVE
Referencia	151040	151050	151070	151080
Medida ext. (AlxAnxF) mm.	270x385x200/300	320x420x200/300	420x385x200/300	520x385x200/300
Medida int. (AlxAnxF) mm.	230x345x145/245	280x380x145/245	380x345x145/245	480x345x145/245
Peso	19,5 kg.	23 kg.	26 kg.	30,5 kg.
Volumen	12-19 L.	15-26 L.	19-32 L.	24-41 L.
Espesor (frente/cuerpo) mm.	6+3 / 2	6+3 / 2	6+3 / 2	6+3 / 2
Bandeja	x	1	1	1
Nº bulones	6/ø22 mm.	7/ø22 mm.	7/ø22 mm.	7/ø22 mm.
Posición bulones				
Código EAN13	* 733646	* 733653	* 733660	* 733677
Medida Packaging (Al x An x F) mm.	285x405x250	335x440x250	435x405x250	535x405x250
PRECIO	215,25€	246,00€	276,75€	307,50€



Toma de corriente externa tipo micro USB.



Fondo regulable, 5 posiciones cada 25 mm.



Bulones guiados por soportes macizos y alojamiento interno para bulones.

PLUS-C

10+3 mm.
Acero antitaladro

ESPESOR FRENTE FONDO REGULABLE

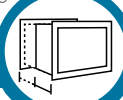

Clasificada en **Grado S2** por el laboratorio **APPLUS** según Norma **UNE EN 14450:2007**, con informe de ensayo 14/9221-1599

NEW

FICHA TÉCNICA

Protección antitaladro:	✓
Tipo de cerradura	Gorjas Certificada EN1300 CLASE A
Llave de emergencia:	-
Pantalla:	✓ 8 dígitos
Códigos apertura:	2
Función máster:	✓
Nº combinaciones	100 millones, de 3 a 8 dígitos
Retardo programable	✓
Bloqueo	✓
Luz interna	✓
Código EAN13	8425181 *
EXTRAS Fondo regulable a 5 posiciones cada 25 mm (200/225/250/275/300 mm).	



PLUS-C
Ref.181050

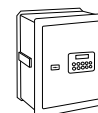

APERTURA	ELECTRÓNICA + LLAVE	ELECTRÓNICA + LLAVE	ELECTRÓNICA + LLAVE	ELECTRÓNICA + LLAVE
Referencia	181040	181050	181070	181080
Medida exterior (Al x An x F)	270x385x200/300 mm.	320x420x200/300 mm.	420x385x200/300 mm.	520x385x200/300 mm.
Medida interior (Al x An x F)	230x345x142/242 mm.	280x380x142/242 mm.	380x345x142/242 mm.	480x345x142/242 mm.
Peso	22,5 kg.	27 kg.	30,7 kg.	33,5 kg.
Volumen	11/19 L.	15/26 L.	19/32 L.	24/40 L.
Espesor (frente / cuerpo)	10+3 mm. / 2 mm.	10+3 mm. / 2 mm.	10+3 mm. / 2 mm.	10+3 mm. / 2 mm.
Bandeja	1	1	1	1
Nº bulones	6/ø22 mm.	7/ø22 mm.	7/ø22 mm.	7/ø22 mm.
Posición bulones				
Código EAN13	* 733455	* 733462	* 733738	* 733745
Medida Packaging (Al x An x F) mm.	285x405x250	335x440x250	435x405x250	535x405x250
PRECIO	281,88€	317,75€	353,63€	389,50€



Bulones giratorios y guiados que impiden su corte desde el exterior. Alojamiento interno para bulones.



Toma de corriente externa tipo micro USB.



Fondo regulable, 5 posiciones cada 25 mm.

PLUS-C

ESPESOR FRENTE FONDO REGULABLE

10+3 mm.
Acero antitaladro



Clasificada en **Grado S2** por el laboratorio **APPLUS** según Norma **UNE EN 14450:2007**, con informe de ensayo 14/9221-1599

NEW

FICHA TÉCNICA

Protección antitaladro:	✓
Tipo de cerradura	Gorjas Certificada EN1300 CLASE A
Llave de emergencia:	-
Pantalla:	-
Códigos apertura:	-
Función máster:	-
Nº combinaciones	-
Retardo programable	-
Bloqueo	-
Luz interna	-
Código EAN13	8425181 *
EXTRAS Fondo regulable a 5 posiciones cada 25 mm (200/225/250/275/300 mm).	



PLUS-C
Ref.181340

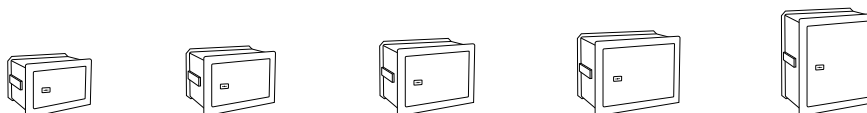

APERTURA	LLAVE	LLAVE	LLAVE	LLAVE	LLAVE
Referencia	181310	181320	181340	181350	181380
Medida exterior (Al x An x F) mm.	210x320x150/220	260x360x150/220	270x385x200/300	320x420x200/300	520x385x200/300
Medida interior (Al x An x F) mm.	170x280x92/162	220x320x92/162	230x345x142/242	280x380x142/242	480x345x142/242
Peso	15 kg.	18 kg.	21,7 kg.	26,1 kg.	38,7 kg.
Volumen	4-8 L.	6-11 L.	11-19 L.	15-26 L.	24-40 L.
Espesor (frente / cuerpo) mm.	10+3 / 2	10+3 / 2	10+3 / 2	10+3 / 2	10+3 / 2
Bandeja	-	1	1	1	1
Nº bulones	2/ø22 mm.	2/ø22 mm.	6/ø22 mm.	7/ø22 mm.	7/ø22 mm.
Posición bulones					
Código EAN13	* 733554	* 733561	* 733516	* 733523	* 733547
Medida Packaging (Al x An x F) mm.	225x340x200	275x380x200	285x405x250	335x440x250	535x405x250
PRECIO	179,38€	205,00€	230,63€	266,50€	338,25€



Cerradura Certificada EN1300 Clase A.



Bulones giratorios y guiados, que impiden su corte desde el exterior



Fondo regulable, 5 posiciones cada 25 mm.

SUPRA

ESPESOR FRENTE
6
mm.

TL



FICHA TÉCNICA

Protección antitaladro:	-
Resistencia al fuego:	✓
Tipo de cerradura	Gorjas
Llave de emergencia:	✓
Pantalla:	✓ 6 dígitos
Códigos apertura:	2
Función máster:	✓
Nº combinaciones	1 millón, de 3 a 6 dígitos
Retardo programable	-
Bloqueo	✓
Luz interna	-
Código EAN13	8425181 *

EXTRAS

Soporta una temperatura exterior de 600° durante 30 minutos, sin que la temperatura interior sobrepase los 170° (el papel se descompone a 177°).



SUPRA
Ref. 240040-IG

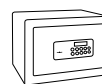

APERTURA	ELECTRÓNICA + LLAVE
Referencia	240040-IG
Medida exterior (Al x An x F)	280x380x345 mm.
Medida interior (Al x An x F)	195x295x240 mm.
Peso	19,8 Kg.
Volumen	15 L.
Espesor (frente / cuerpo)	6 mm. / 40 mm.
Bandeja	x
Nº bulones	2/ø20 mm.
Posición bulones	
Código EAN13	* 734360
Medida Packaging (Al x An x F)	320x420x385 mm.
PRECIO	176,81€

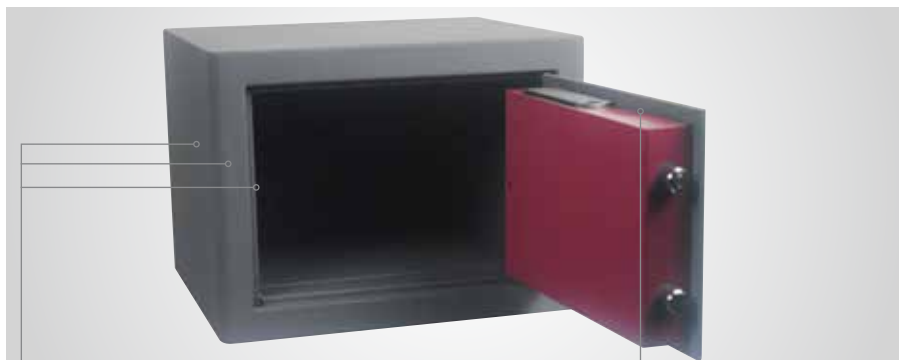

2 mm. + 2 mm. + 36 mm. De acero relleno de material ignífugo

Juntas de material ignífugo.



Bulones giratorios y guiados, que impiden su corte desde el exterior

RESIST

ESPESOR FRENTE

98
mm.



LFS 60P,
según Norma
Europea EN15659



FICHA TÉCNICA

Protección antitaladro:	-
Resistencia al fuego:	✓
Tipo de cerradura:	Llave
Llave de emergencia:	✓
Pantalla:	-
Códigos apertura:	2
Función máster:	✓
Nº combinaciones	1 millón, de 4 a 6 dígitos
Retardo programable	-
Bloqueo	✓
Luz interna	-
Código EAN13	8425181 *

- Mantiene una temperatura interior por debajo de los 170°C durante 1 hora.
- Las ref. 41260 y 41270 incluyen un cajón interior con llave.



RESIST
Ref. 41240

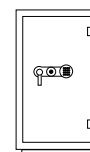
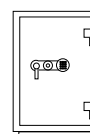

APERTURA	ELECTRÓNICA + LLAVE	ELECTRÓNICA + LLAVE	ELECTRÓNICA + LLAVE	ELECTRÓNICA + LLAVE
Referencia	41220	41240	41260	41270
Medida exterior (Al x An x F)	315x445x425 mm.	510x445x425 mm.	792x485x450 mm.	972x565x450 mm.
Medida interior (Al x An x F)	207x341x296 mm.	402x341x296 mm.	607x346x301 mm.	786x426x301 mm.
Peso	38 kg.	54 kg.	103 kg.	138 kg.
Volumen	21 L.	41 L.	64/8 L.	98/10 L.
Espesor (frente / cuerpo)	98 mm. / 52 mm.	98 mm. / 52 mm.	98 mm. / 52 mm.	98 mm. / 52 mm.
Bandeja	x	1	1	1
Nº bulones	2/∅14 mm.	2/∅14 mm.	3/∅24 mm.	5/∅24 mm.
Posición bulones				
Código EAN13	* 734124	* 734131	* 734148	* 734155
Medida Packaging (Al x An x F) mm.	355x475x480	550x475x450	790x510x510	970x580x520
PRECIO	246,00€	353,63€	640,63€	871,25€



Portapilas alojado en el exterior bajo el teclado.



Resistente al fuego. Certificado según norma europea EN15659.



Incluye bandeja extraíble en la parte superior.

GAMA BRACO

ESPESOR FRENTE

2 mm.



FICHA TÉCNICA

Tipo de cerradura	6 gorjas asimétricas con llave doble paletón
Código EAN13	8425181 *
EXTRAS	
<ul style="list-style-type: none"> Estantes para armas realizados en goma. Cajón con llave (ref. ARM050335, ARM070335, ARM100335) 	

ARMERO ESCOPETAS
Ref. ARM050335



- El armero ARM030325 corresponde al modelo anterior APF.2K.
- El armero ARM050335 corresponde al modelo anterior APF.4KTADV.

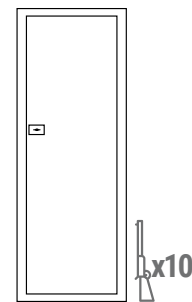
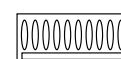
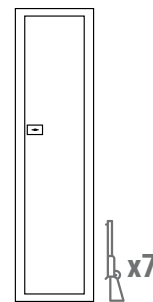
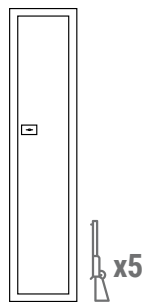
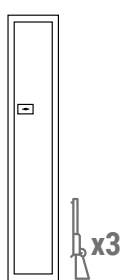
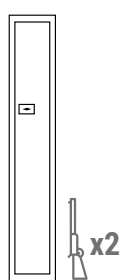
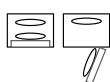

Nº ESCOPETAS	2 ESCOPETAS	3 ESCOPETAS	5 ESCOPETAS	7 ESCOPETAS	10 ESCOPETAS
Referencia	ARM020325	ARM030325	ARM050335	ARM070335	ARM100335
Apertura	Llave	Llave	Llave	Llave	Llave
Medida exterior (Al x An x F) mm.	1.255x205x150	1.255x245x205	1.380x315x205	1.380x370x205	1.380x540x205
Medida interior (Al x An x F) mm.	1.250x200x145	1.250x240x175	1.190x310x165	1.190x360x165	1.190x530x165
Peso	15,7 kg.	20,2 kg.	31,2 kg.	34,2 kg.	37,5 kg.
Volumen	30 L.	52,5 L.	61 L.	75,6 L.	105 L.
Espesor (frente / cuerpo) mm.	2 / 2	2 / 2	2 / 2	2 / 2	2 / 2
Cajón interior	x	x	✓	✓	✓
Nº bulones (mm.)	3/ø10	2/ø18	2/ø18	2/ø18	2/ø18
Posición bulones					
Código EAN13	* 735237	* 735244	* 735251	* 735268	* 735398
Medida Packaging (Al x An x F) (mm.)	1300x210x165	1300x250x220	1425x320x220	1425x375x220	1425x545x220
PRECIO	145,00€	169,00€	219,00€	255,00€	309,00€

WOOD

ESPEJOR FREITE

2
mm.



FICHA TÉCNICA

Tipo de cerradura	6 gorjas asimétricas con llave doble paletón
Materiales	Acero acabado madera.
Código EAN13	8425181 *
EXTRAS	
<ul style="list-style-type: none"> Estantes para 5 armas realizados en goma. Cajón con llave 	

ARMERO ESCOPETAS
Ref. ARM058335



Nº ESCOPETAS	5 ESCOPETAS
Referencia	ARM058335
Apertura	Llave
Medida exterior (Al x An x F) mm.	1380x315x205 mm.
Medida interior (Al x An x F) mm.	1.200x310x165 mm.
Peso	31,2 kg.
Volumen	65 L.
Espesor (frente / cuerpo) mm.	2 mm.
Cajón interior	✓
Nº bulones (mm.)	2/ø18 mm.
Posición bulones	-
Código EAN13	* 735435
Medida Packaging (Al x An x F) (mm.)	1.425x320x220 mm.
PRECIO	255,00€

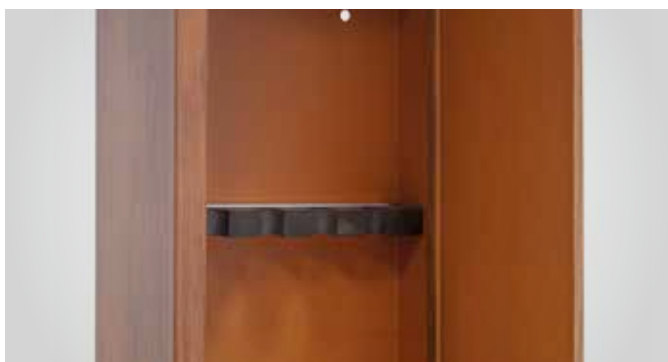

Estantes para escopetas realizados en goma.



Cajón interior con llave.

STYLO

ESPESOR FRENTE

3 mm.



FICHA TÉCNICA

Protección antitaladro:	-
Llave de emergencia:	✓
Códigos apertura:	2
Función máster:	✓
Nº combinaciones	100 millones, de 3 a 8 dígitos
Retardo programable	-
Bloqueo	✓
Luz interna	-
Código EAN13	8425181 *

EXTRAS:

- Un sistema de protección anti-ganzúa evita que pueda ser manipulado desde el exterior.

OPCIONAL

- Las refs. 19000-S3 y 19000-S4 incluyen la opción de llave de alquiler.



STYLO
Ref. 19000-S4

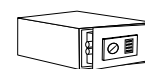
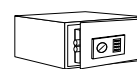
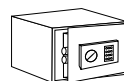
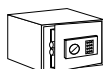

APERTURA	ELECTRÓNICA + POMO	ELECTRÓNICA + POMO	ELECTRÓNICA + POMO	ELECTRÓNICA + POMO
Referencia	19000-S1	19000-S2	19000-S3	19000-S4
Medida exterior (Al x An x F)	200x310x200 mm.	250x350x250 mm.	200x430x350 mm.	200x457x404 mm.
Medida interior (Al x An x F)	185x305x130 mm.	245x345x180 mm.	190x420x300 mm.	190x440x354 mm.
Peso	4,6 kg.	6,2 kg.	8 kg.	8 kg.
Volumen	7,5 L.	15,2 L.	24 L.	30 L.
Espesor (frente / cuerpo)	3 mm. / 1,2 mm.	3 mm. / 1,2 mm.	3 mm. / 1,2 mm.	3 mm. / 1,2 mm.
Bandeja	-	-	-	-
Nº bulones	2/∅16 mm.	2/∅20 mm.	2/∅18 mm.	2/∅18 mm.
Posición bulones				
Código EAN13	* 726174	* 726181	* 727911	* 727751
Medida Packaging (Al x An x F)	220x330x240 mm.	270x390x270 mm.	220x450x395 mm.	220x480x435 mm.
PRECIO	55,35€	68,68€	80,98€	91,23€



Opción llave de alquiler en refs. 19000-S3 y 19000-S4.



Stylo 19000-S2.



Dispone de llave de emergencia tubular para su uso en caso de olvido del código secreto.

TRAVEL



ESPESOR FRENTE

5 mm.



FICHA TÉCNICA

Protección antitaladro:	-
Llave de emergencia:	✓
Pantalla:	6 dígitos
Códigos apertura:	2
Función máster:	✓
Nº combinaciones	1 millón, de 4 a 6 dígitos
Retardo programable	-
Bloqueo	✓
Luz interna	-
Código EAN13	8425181 *

EXTRAS:

- Memoria Flash-Ram: la información no se pierde aunque la caja se quede sin pilas.

OPCIONAL

- Sistema de alquiler mediante varilla magnética que activa la caja fuerte
- Enchufe EURO AMERICANO (plano+redondo) que permite cargar laptop, ipad, tablet, etc.



TRAVEL
Ref. 51300-S3B

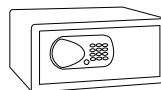

APERTURA	ELECTRÓNICA MOTORIZADA
Referencia	51300-S3B
Medida exterior (Al x An x F)	200x418x381 mm.
Medida interior (Al x An x F)	196x414x326 mm.
Peso	10 kg.
Volumen	25 L.
Espesor (frente / cuerpo)	5 mm. / 1,5 mm.
Bandeja	1
Nº bulones	2/ø20 mm.
Posición bulones	
Código EAN13	* 731871
Medida Packaging (Al x An x F)	220x420x400 mm.
PRECIO	112,75€



Opcional varilla magnética para activar la caja fuerte en sistemas de alquiler.



Dispone de llave de emergencia.



LUZ LED INTERIOR

FICHA TÉCNICA

Código EAN13

8425181 *

- Ilumina el interior de la caja fuerte facilitando manipular su contenido.
- Se enciende automáticamente en cuanto detecta movimiento y se apaga sola al cabo de unos segundos.
- Instalación inmediata mediante imán.
- Permite fijarlo a cualquier pared de la caja.
- Incluye 3 pilas alcalinas.



Ref. COM001

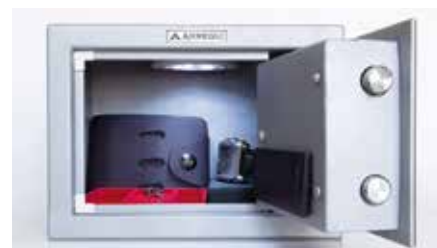

Referencia	COM001
Medida exterior (Al x An x F)	85x85x20 mm.
Código EAN13	* 726785
Medida Packaging (Al x An x F)	223x123x30 mm.
PRECIO	8'41€

LLAVES

MODELO	REFERENCIA	LLAVE EN BRUTO USUARIO	PRECIO	LLAVE EN BRUTO EMERGENCIA	PRECIO	DUPLICADO LLAVE USUARIO	PRECIO	DUPLICADO LLAVE EMERGENCIA	PRECIO
BASA	20000-S7			165LLG	1,18€			165LLE	2,36€
	20000-S7K	EK-BKLLCF	2,97€			EK-LLCF	5,95€		
GRID	13000W	BK0090G	4,61€			BK0090	22,55€		
SOCKET	23000W								
BOX-IN	22000								
	22100								
COVER	172060	30LLG	2,97€	30LLG	2,97€	30LLCF	5,95€	30LLE	5,95€
PREMIER	16501/16501W			165LLG	1,18€			165LLE	2,36€
NEW STYLO	19010/19010W	311LLG	2,97€	EB-LLEB		311LLCF	5,95€	EB-LLET	
STYLO	19000			19LLEBS4				19LLES4	
CLASS	T17K/25K	EK-BKLLCF	2,97€			EK-LLCF	5,95€		
	T-20/25/35EB			EB-LLEB	1,18€			EB-LLET	
	W-25EB								
SUPRA	ELECTRÓNICA + LLAVE	30LLG	2,97€	30LLG	2,97€	30LLCF	5,95€	30LLE	5,95€
	MOTORIZADA			24LLEG				24MLLE	
	IGNÍFUGA	30LLG		30LLG		30LLCF		30LLE	
FORMA EVOLUTION	ELECTRÓNICA + LLAVE	10LLG		10LLEG		10LLCF		10LLE	
FORMA C	ELECTRÓNICA + LLAVE	10LLG		10LLEG		10LLCF		10LLE	
PLUS C	ELECTRÓNICA + LLAVE	18LLG (*)	4,61€			18LLCF (*)	11,79€		
	LLAVE								
IDEAL 5	271310/20	DBC-LLEG	2,97€			DGC-LL	5,95€		
IGNUM	41010			41LLEG	2,97€			41LLEPM	5,95€
TRAVEL	51300			512LLEG	1,18€			512LLE	2,36€
D-APF.2K	D-APF.2K	DBC-LLEG	2,97€			DGC-LL	5,95€		
D-APF.4K	D-APF.4K								
D-APF.4KTADV	D-APF.4KTADV								
D-APF.4KTCMF	D-APF.4KTCMF								
RESIST LLAVE	41220			412LLEG	4,61€				

(*) Para el duplicado de llaves es necesaria la presentación de la tarjeta de propiedad de la caja y solo puede ser realizado por un distribuidor autorizado por ARREGUI.



SEGURIDAD

 **ARREGUI**

www.arregui.es

ELEGANT

FICHA TÉCNICA

Material	Acero pintado.
Apertura	Llave de serreta
Colores	Disponible en 3 colores: rojo, azul y grafito.
Práctico	Incluye bandeja multifunción para guardar pequeños objetos o monedas.
Código EAN13	8425181 *

EXTRAS
Dispone de asa que facilita su transporte.

El tamaño 0 dispone de ranura para introducir monedas.



El tamaño 0 incorpora una ranura para depositar monedas.

Todos los tamaños incorporan una bandeja multifunción.

ELEGANT	REF.	TAMAÑO	COLOR	MEDIDA EXTERIOR (Al x An x F mm)	MEDIDA PACKAGING (Al x An x F mm)	EAN13	PRECIO
	C-9004 C-9005 C-9006	0	ROJO AZUL GRAFITO	60x125x95	60x125x95	* 190043 * 190050 * 190067	7,18 € 7,18 € 7,18 €
	C-9214 C-9215 C-9216	1	ROJO AZUL GRAFITO	80x152x118	80x152x118	* 192146 * 192153 * 192160	8,82 € 8,82 € 8,82 €
	C-9224 C-9225 C-9226	2	ROJO AZUL GRAFITO	90x200x160	90x200x160	* 192245 * 192252 * 192269	10,61 € 10,61 € 10,61 €
	C-9234 C-9235 C-9236	3	ROJO AZUL GRAFITO	90x250x180	90x250x180	* 192344 * 192351 * 192368	13,33 € 13,33 € 13,33 €
	C-9244 C-9245 C-9246	4	ROJO AZUL GRAFITO	90x300x240	90x300x240	* 192443 * 192450 * 192467	16,20 € 16,20 € 16,20 €

CASHIER

FICHA TÉCNICA

Material	Acero pintado color grafito
Apertura	Mediante llave de serreta.
Práctico	Incorpora una bandeja para monedas de euro y otra adicional para billetes.
Código EAN13	8425181 *

EXTRAS
Incluye colchón de espuma para evitar que las monedas se muevan una vez cerrada la caja.

Dispone de asa que facilita su transporte.

PACKAGING (mm)

PACKAGING 90x300x240	
--------------------------------	--



Referencia	C-9246-EUR
Medida exterior (Al x An x F mm)	90x300x240
Código EAN13	* 192474
PRECIO	17,94 €

POP-UP

FICHA TÉCNICA

Material	Acero pintado color grafito
Apertura	Llave de serreta y pulsador
Práctica	Incluye bandeja multifunción. Con asa que facilita su transporte.
Código EAN13	8425181 *



C9736



La apertura se realiza mediante llave y pulsador.

PACKAGING



POP-UP				
Referencia	C-9716	C-9726	C-9736	C-9746
Medida exterior (Al x An x F mm)	80x152x115	90x200x160	90x250x180	90x300x240
Medida packaging (Al x An x F mm)	80x152x115	90x200x160	90x250x180	90x300x240
Código EAN13	* 197165	* 197264	* 197363	* 197462
PRECIO	11,74€	13,58 €	17,02 €	19,99 €

BRIC

FICHA TÉCNICA

Material	Acero pintado negro texturado.
Apertura	Sistema de apertura: Electrónico con pomo. Código de acceso: Libre elección del código de apertura de 1 a 8 dígitos. Apertura de emergencia: Dispone de llave de emergencia para su uso en caso de olvido del código secreto o cuando se agoten las pilas.
Código EAN13	8425181 *
Medida Packaging (Al x An x F mm)	280x325x150 mm.
EXTRAS	Dispone de asa que facilita su transporte. Dispone de almohadilla interior que protege los objetos depositados en la caja.



BRIC
C-9547



Sistema de apertura electrónico con pomo.



Caja de seguridad transportable.

Referencia	C-9547
Medida exterior (Al x An x F mm)	130x325x255
Peso	5 kg
Código EAN13	* 195475
PRECIO	47,15 €

PRIVATE

FICHA TÉCNICA

Material	Acero pintado color negro.
Apertura	Las ref. C-9327 y C-9467 se abren mediante llave. La ref. C-9427 se abre mediante combinación.
Práctico	Caja de seguridad con elementos de seguridad para su posible fijación.
Código EAN13	8425181 *

EXTRAS

C-9427 Y C-9467: Dispone de un cable de acero de 1 metro para amarrar la caja a un lugar fijo, sin que se pueda soltar.

C-9327: Dispone de una base de acero fácil de fijar que hace que la caja se amarre a la base y se bloquee mediante la llave, sin posibilidad de moverla.

Dispone de almohadilla interior que protege su contenido.



C-9327

PRIVATE			
Referencia	C-9327	C-9427	C-9467
Medida exterior (Al x An x F mm)	75x160x203	65x150x203	95x150x203
Medida Packaging (Al x An x F mm)	75x165x205	65x156x205	95x156x205
Peso	1,3 kg	0,8 kg	0,9 kg
Código EAN13	* 193273	* 194270	* 194676
PRECIO	17,68 €	14,66 €	19,32 €

PACKAGING



Ref. C-9327: Dispone de una caja de acero que permite sujetarlo a un lugar fijo.



Ref. C-9427 y C-9467: El cable de acero permite amarrarlo a un lugar fijo.

HUCHA MAIL

FICHA TÉCNICA

Material	Acero pintado
Apertura	Mediante llave.
Comodidad	Dispone de ranura para depositar el dinero y posibilidad de extraerlo cómodamente abriendo la puerta frontal del buzón.
Código EAN13	8425181 *



C-9701



C-9702

PACKAGING (mm)

PACKAGING 93x152x83	
-------------------------------	--

	C-9701	C-9702
Referencia	C-9701	C-9702
Medida exterior (Al x An x F mm)	93x152x83	93x152x83
Código EAN13	* 197011	* 197028
PRECIO	6,61 €	6,61 €



Apertura frontal mediante llave.



Ranura superior para depositar las monedas.

BOOK

FICHA TÉCNICA

Material	Acero pintado y papel
Apertura	Llave de serreta
Diseño	Simulando ser un libro en su interior se oculta una caja de seguridad.
Código EAN13	8425181 *

EXTRAS
Por motivos de seguridad la imagen de la portada que se muestra tanto en este catálogo como en el embalaje no se corresponde con la imagen del envase real.

PACKAGING (mm)

PACKAGING
226x158x48



C-9381



La caja queda camuflada en la librería entre el resto de libros sin levantar sospechas.



Dispone de capacidad para pequeños objetos de valor.



Incorpora todas las características de un libro real, incluyendo las hojas de papel.

Referencia	C-9381
Medida exterior (Al x An x F mm)	222x154x44
Medida interior (Al x An x F mm)	160x92x36.
Código EAN13	* 193815
PRECIO	17,84 €

CHEF

FICHA TÉCNICA

Material	Acero pintado
Apertura	Llave de serreta
Diseño	Simulando ser un envase para alimentos en su interior se oculta una caja de seguridad.
Código EAN13	8425181 *

EXTRAS
Por motivos de seguridad la imagen del alimento envasado que se muestra tanto en este catálogo como en el embalaje no se corresponde con la imagen del envase real.

PACKAGING (mm)

PACKAGING
190x137x70



C-9371



Arregui modifica las tapas del envase de forma periódica.



La caja queda camuflada en la despensa junto al resto de envases.



Dispone de capacidad para pequeños objetos de valor.

Referencia	C-9371
Medida exterior (Al x An x F mm)	188x137x68
Medida interior (Al x An x F mm)	183x133x53
Código EAN13	* 193716
PRECIO	11,07 €

NOVEL

FICHA TÉCNICA

Material	Acero y plástico
Apertura	Combinación
Diseño	Simula ser un libro pero en su interior se oculta una caja de seguridad.
Código EAN13	8425181 *

EXTRAS
Se incluyen 3 carátulas diferentes para la portada.

PACKAGING (mm)

PACKAGING
191x124x59



C-9387



NEW

Referencia	C-9387
Medida exterior (Al x An x F mm)	184x117x50
Medida interior (Al x An x F mm)	166x105x43
Código EAN13	* 733981
PRECIO	12,81 €

POTTY

FICHA TÉCNICA

Material	Acero y plástico
Apertura	Llave
Diseño	Simula ser una maceta pero en su interior se oculta una caja de seguridad.
Código EAN13	8425181 *

PACKAGING (mm)

PACKAGING
120x100x100



C-9351



NEW

Referencia	C-9351
Medida exterior (Al x An x F mm)	184x117x50
Medida interior (Al x An x F mm)	166x105x43
Código EAN13	* 733998
PRECIO	12,81 €

SECRET CAN

FICHA TÉCNICA

Material	Acero
Apertura	Mediante tapa a rosca
Diseño	Simulando ser una lata de conserva en su interior esconde un compartimento para guardar pequeños objetos de valor.
Código EAN13	8425181 *

PACKAGING (mm)

PACKAGING 115x80x77	
-------------------------------	--



C-9361

Referencia	C-9361
Medida exterior (Al x Ø mm)	109x75
Unidades compra mínima	6
Código EAN13	* 721087
PRECIO	6,41€

SECRET SPRAY

FICHA TÉCNICA

Material	Acero
Apertura	Mediante tapa a rosca
Diseño	Simulando ser un bote de espuma de afeitado o de aceite lubricante multiusos en su interior esconde un compartimento para guardar pequeños objetos de valor.
Código EAN13	8425181 *

PACKAGING (mm)

PACKAGING 172x70x70	
-------------------------------	--



C-9362

Referencia	C-9362
Medida exterior (Al x Ø mm)	170x70
Unidades compra mínima	6
Código EAN13	* 722862
PRECIO	7,48 €

KEEPER

FICHA TÉCNICA

Material	Acero de gran resistencia
Apertura	Sistema de apertura: Mediante combinación. Permite cambiar el código de combinación cuantas veces se desee.
Instalación	Para fijar en la pared
Práctico	Adecuada para guardar en ella llaves o tarjetas que permitirán el acceso a viviendas o bienes de alquiler, locales de uso compartido, vehículos, etc.
Código EAN13	8425181 * *
EXTRAS	Parte trasera acolchada

PACKAGING (mm)

Medida Packaging (Al x An x F)

90x150x50

203x100



SEG011



SEG012



**KEEPER
SEG011**
Con funda protectora.



NEW



**KEEPER
SEG012**



Referencia	SEG011	SEG012
Medida exterior (Al x An x F mm)	125x80x32	118x85x35
Código EAN13	* 723586	* 734063
PRECIO	31,78 €	28,19 €

KEEPER MÓVIL

FICHA TÉCNICA

Material	Cuerpo y arco de acero resistente contra golpes y agresiones. Resistente a la intemperie
Apertura	Mediante combinación. Permite cambiar el código de combinación cuantas veces se desee.
Diseño	Caja guardallaves con candado que facilita su sujeción a un lugar fijo.
Código EAN13	8425181 * *
Extras	Parte trasera acolchada para evitar rozaduras.

PACKAGING (mm)

PACKAGING
75x190x43



**KEEPER MÓVIL
SEG021**



Referencia	SEG021
Medida exterior (Al x An x F mm)	134x70x37
Código EAN13	* 723593
PRECIO	25,78 €

ARMARIO DE LLAVES REGULABLE

FICHA TÉCNICA

Material	Acero pintado color gris claro.
Apertura	Mediante llave de serreta
Práctico	Contiene portaetiquetas para identificar las llaves. Dispone de ganchos de sujeción móviles y regulables en altura con números de referencia en la parte superior (se incluyen tiras de numeración).
Código EAN13	8425181 *
Extras	Incorpora en su interior una funda portadocumentos.



PL100



Armario 60 llaves.



Armario 100 llaves.



Armario 200 llaves.



Armario 300 llaves.

	60 llaves	100 llaves	200 llaves	300 llaves
ARMARIO DE LLAVES REGULABLE				
Referencia	PL060	PL100	PL200	PL300
Nº Llaves	60	100	200	300
Medida Exterior (Al x An x F mm)	450x300x80	550x380x80	550x380x140	550x380x205
Medida Packaging (Al x An x F mm)	460x310x90	560x390x90	560x390x150	570x390x220
Código EAN13	* 100608	* 101001	* 102008	* 103005
PRECIO	44,64 €	67,04 €	89,64 €	137,15 €

PACKAGING



PORTA ETIQUETAS PARA LLAVES

FICHA TÉCNICA

Código EAN13	8412446 *
<p>Juego de 12 llaveros con porta etiquetas para identificar las llaves. Fabricado en plástico flexible. Colores surtidos.</p>	



PORTA ETIQUETAS PARA LLAVES
A-1642052

Referencia	A-1642052
Medida exterior (Al x An mm)	20X48
Código EAN13	* 420526
PRECIO	1,28 €

ARMARIO DE LLAVES FIJO

FICHA TÉCNICA

Material	Acero pintado.
Apertura	Mediante llave de serreta
Color	Gris claro
Práctico	Contiene portaetiquetas para identificar las llaves. Dispone de ganchos de sujeción fijos con números de referencia en la parte superior (se incluyen tiras de numeración).
Código EAN13	8425181 *



PLL90



Armario 20 llaves.



Armario 90 llaves.

PACKAGING



	PLL20	PLL40	PLL60	PLL90
ARMARIO DE LLAVES FIJO				
Referencia	PLL20	PLL40	PLL60	PLL90
Nº Llaves	20	40	60	90
Medida exterior (Al x An x F mm)	200x160x60	200x160x80	250x180x80	300x240x80
Medida packaging (Al x An x F mm)	200x160x60	200x160x80	250x180x80	300x240x80
Código EAN13	* 110201	* 110409	* 110607	* 110904
PRECIO	11,99 €	18,45 €	23,32 €	31,78 €

QUICK

FICHA TÉCNICA

Material	Acero inoxidable satinado.
Código EAN13	8425181 *
Práctico	Organizador de llaves, documentos y tablero de notas. Incluye un alojamiento especial para móviles o elementos de escritura. Incluye 2 imanes.



PLD-07



PACKAGING (mm)

PACKAGING 200x190x40	
--------------------------------	--

Referencia	PLD-07
Medida exterior (Al x An x F mm)	150x180x35
Código EAN13	* 107072
PRECIO	12,30 €

SERIE COMBI STANDARD

FICHA TÉCNICA

Cuerpo	Latón macizo
Arco	Acero cromado.
Cierre de seguridad	Simple.
Mecanismo de apertura	Combinación de 3 discos. Código reprogramable.
Nivel de seguridad:	1 2 3 4 5
Código EAN13	8412446 *
Medida Packaging (Al x An mm)	151x90

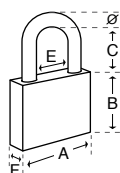

A-1311982



REF.	A	B	C	∅	E	F	NIVEL SEG.	UNID./CAJA	EAN	PRECIO
A-1311982	20 mm	30 mm	21 mm	3 mm	9 mm	9,9 mm	2	12	* 919884	3,64 €

SERIE COMBI COLOR

FICHA TÉCNICA

Cuerpo	Aleación de zinc pintado en plata o rojo.
Arco	Acero cromado.
Cierre de seguridad	Simple.
Mecanismo de apertura	Combinación de 4 discos. Código reprogramable.
Nivel de seguridad:	1 2 3 4 5
Código EAN13	8425181 *
Medida Packaging (Al x An mm)	151x90

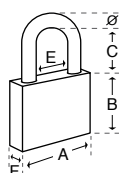

A-1312040



REF.	A	B	C	∅	E	F	NIVEL SEG.	UNID./CAJA	EAN	PRECIO
A-1312040	20 mm	37 mm	21 mm	3 mm	9 mm	10,7 mm	2	6 (3 rojo+3 plata)	* 722367	3,02 €

SERIE COMBI DESIGN

FICHA TÉCNICA

Cuerpo	Latón macizo decorado
Arco	Acero cromado.
Cierre de seguridad	Simple.
Mecanismo de apertura	Combinación de 3 números. Código reprogramable.
Nivel de seguridad:	1 2 3 4 5
Código EAN13	8425181 *
Medida Packaging (Al x An mm)	151x90

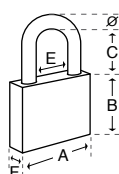

A-1313030



DESIGN
FLOWERS



A-1313040



DESIGN
SQUARES

REF.	A	B	C	∅	E	F	NIVEL SEG.	UNID./CAJA	EAN	PRECIO
A-1313030	25 mm	30 mm	21 mm	3 mm	13 mm	10,5 mm	2	6	* 723494	5,07 €
A-1313040	25 mm	30 mm	21 mm	3 mm	13 mm	10,5 mm	2	6	* 723500	5,07 €

MOSQUETÓN COMBI

FICHA TÉCNICA

Cuerpo	Aleación de zinc, pintado en naranja.
Cierre de seguridad	Simple.
Mecanismo de apertura	Combinación de 3 números. Código reprogramable.
Nivel de seguridad:	1 2 3 4 5
Código EAN13	8425181 *
Medida Packaging (Al x An mm)	174x93

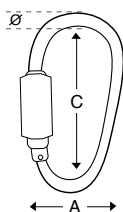

A-1313130



NEW

REF.	A	C	∅	NIVEL SEG.	UNID./CAJA	EAN	PRECIO
A-1313130	60 mm	91,5 mm	8,5 mm	2	6	* 732694	4,05 €

SERIE COMBI ARCO FLEXIBLE

FICHA TÉCNICA

Cuerpo	Aleación de zinc, pintado en gris o rosa.
Arco	Arco flexible de acero con recubrimiento de PVC.
Cierre de seguridad	Simple.
Mecanismo de apertura	Combinación de 3 discos. Código reprogramable.
Nivel de seguridad:	1 2 3 4 5
Código EAN13	8425181 *
Medida Packaging (Al x An mm)	151x90

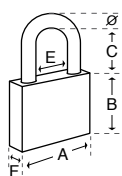

A-1313110



A-1313111



NEW

REF.	A	B	C	Ø	E	F	NIVEL SEG.	UNID./CAJA	EAN	PRECIO
A-1313110	28,5 mm	39,5 mm	55 mm	2,8 mm	12,2 mm	11,6 mm	2	6	* 732717	4,56 €
A-1313111	28,5 mm	39,5 mm	55 mm	2,8 mm	12,2 mm	11,6 mm	2	6	* 732724	4,56 €

SERIE COMBI CON LLAVE DE EMERGENCIA

FICHA TÉCNICA

Cuerpo	Aleación de zinc.
Arco	Acero cromado.
Cierre de seguridad	Doble cierre
Mecanismo de apertura	Combinación de 4 discos. Código reprogramable.
Llave de emergencia:	Con llave de emergencia en caso de pérdida de código de apertura. Por seguridad la llave tiene múltiples combinaciones distintas.
Nivel de seguridad:	1 2 3 4 5
Código EAN13	8425181 *
Medida Packaging (Al x An mm)	165x104

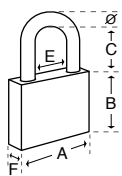

A-1313150

NEW

REF.	A	B	C	Ø	E	F	NIVEL SEG.	UNID./CAJA	EAN	PRECIO
A-1313150	34,7 mm	59 mm	22 mm	5 mm	16 mm	13,6 mm	3	6	* 734353	12,15 €

SERIE ALUMINIO COMBI / LLAVE

FICHA TÉCNICA

Cuerpo	Aluminio
Arco	Acero cromado / Acero endurecido cromado.
Cierre de seguridad	Simple.
Mecanismo de apertura	A-1313080 / A-1313081 Combinación de 4 discos. Código reprogramable. A-1313140 Cerradura de bombillo con pines de latón.
Nivel de seguridad:	(080-081) 1 2 3 4 5 (140) 1 2 3 4 5
Código EAN13	8425181 *
EXTRAS:	Especial para exterior. / Personalizable mediante rotulador indeleble o grabación.
Medida Packaging (Al x An mm)	152x90

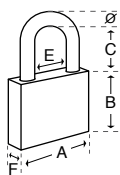

A-1313080



A-1313081



A-1313140



NEW

REF.	A	B	C	Ø	E	F	NIVEL SEG.	UNID./CAJA	EAN	PRECIO
A-1313080	30 mm	45 mm	26 mm	5 mm	14 mm	12,3 mm	4	6	* 727577	7,28 €
A-1313081	30 mm	45 mm	26 mm	5 mm	14 mm	12,3 mm	4	6	* 732700	7,28 €
A-1313140	38 mm	40,5 mm	27 mm	5,8 mm	20 mm	18,5 mm	5	6	* 732762	10,10 €

SERIE STANDARD

FICHA TÉCNICA

Cuerpo	Latón Macizo.
Arco	Acero cromado.
Cierre de seguridad	Simple.
Mecanismo de apertura	Cerradura de bombillo con pines de latón.
Llaves	3 llaves cromadas de serreta simple dentado.
Nivel de seguridad:	(602-612-622) 1 2 3 4 5
	(662) 1 2 3 4 5
	(542) 1 2 3 4 5
Código EAN13	8412446 *
Medida Packaging (Al x An mm)	138x78



A-1311602



A-1311622



A-1311662

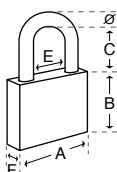

A-1311612



Pack de 2 candados de 20mm con llaves iguales
A-1311542

REF.	A	B	C	Ø	E	F	NIVEL SEG.	UNID./CAJA	EAN	PRECIO
A-1311602	20 mm	16 mm	13 mm	3,5 mm	10 mm	8 mm	2	6	* 116092	1,69 €
A-1311612	30 mm	20 mm	19 mm	5 mm	16 mm	9 mm	2	12	* 116191	2,36 €
A-1311622	40 mm	28 mm	23 mm	5,5 mm	25 mm	11 mm	2	6	* 116290	3,79 €
A-1311662	40 mm	28 mm	73 mm	6 mm	23 mm	11 mm	3	12	* 116634	4,00 €
A-1311542 (pack 2 unid)	20 mm	16 mm	13 mm	3,5 mm	10 mm	8 mm	2	6	* 721339	3,02 €

SERIE PRIME

FICHA TÉCNICA

Cuerpo	Latón Macizo.
Arco	Acero endurecido cromado.
Cierre de seguridad	Doble cierre del arco, mayor resistencia al impacto.
Mecanismo de apertura	Cerradura de bombillo con pines de latón.
Llaves	3 llaves cromadas de serreta simple dentado.
Nivel de seguridad:	(912-900) 1 2 3 4 5
	(922-932-942) 1 2 3 4 5
Diseño antipalanca:	Presenta un rebaje que reduce el ángulo de fuerza para ejercer palanca contra el candado.
Código EAN13	8412446 *
EXTRAS	Incluye orificio de drenaje de agua para aumentar la resistencia a la intemperie.
Medida Packaging (Al x An mm)	151x90



A-1311912



Pack de 2 candados de 30 mm. con llaves iguales
A-1311900



A-1311922



A-1311932



Doble cierre de seguridad

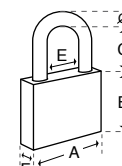

A-1311942

REF.	A	B	C	Ø	E	F	NIVEL SEG.	UNID./CAJA	EAN	PRECIO
A-1311912	30 mm	28 mm	18 mm	5 mm	16 mm	13 mm	3	6	* 119178	3,69 €
A-1311900 (pack 2 unid)	30 mm	28 mm	18 mm	5 mm	16 mm	13 mm	3	6	* 722633	6,66 €
A-1311922	40 mm	33 mm	24 mm	6 mm	23 mm	14 mm	4	6	* 119277	5,02 €
A-1311932	40 mm	34 mm	55 mm	6 mm	23 mm	14 mm	4	6	* 732687	6,05 €
A-1311942	50 mm	40 mm	31,5 mm	8 mm	27,5 mm	16,5 mm	4	6	* 119475	8,61 €

SERIE COLOR

FICHA TÉCNICA

Cuerpo	Acero macizo niquelado con recubrimiento de plástico rojo o azul.
Arco	A-1312000 / A-1312010: Acero Cromado A-1312020 / A-1312030: Acero Endurecido Cromado
Cierre de seguridad	Simple.
Mecanismo de apertura	Cerradura de bombillo con pines de latón.
Llaves	3 llaves cromadas de serreta simple dentado.
Nivel de seguridad:	(000-010) 1 2 3 4 5 (020-030) 1 2 3 4 5
Código EAN13	8425181 *
EXTRAS	Incluye orificio de drenaje de agua para aumentar la resistencia a la intemperie.
Medida Packaging (Al x An mm)	151x90

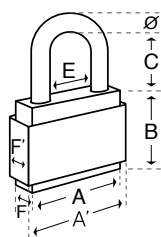

A-1312000



A-1312010

Pack de 2 candados de 20mm con llaves iguales



A-1312020



A-1312030

Pack de 2 candados de 30mm con llaves iguales

REF.	A	A'	B	C	Ø	E	F	F'	NIVEL SEG.	UNID./CAJA	EAN	PRECIO
A-1312000	20	25	20	18	3	10	10,4	14,2	2	12 (6 rojo+6 azul)	* 722329	1,69 €
A-1312010 (pack 2 unid)	20	25	20	18	3	10	10,4	14,2	2	6 (3 rojo+3 azul)	* 722336	3,02 €
A-1312020	30	35	28	18	5	16	14	18,7	3	12 (6 rojo+6 azul)	* 722343	2,36 €
A-1312030 (pack 2 unid)	30	35	28	18	5	16	14	18,7	3	6 (3 rojo+3 azul)	* 722350	4,20 €

*Medidas mm.

SERIE DESIGN

FICHA TÉCNICA

Cuerpo	Hierro macizo decorado.
Arco	Acero endurecido cromado.
Cierre de seguridad	Doble bloqueo del arco, mejor resistencia al impacto.
Mecanismo de apertura	Cerradura de bombillo con pines de latón.
Llaves	3 llaves cromadas de serreta simple dentado.
Nivel de seguridad:	1 2 3 4 5
Diseño antipalanca:	Presenta un rebaje que reduce el ángulo de fuerza para ejercer palanca contra el candado.
Código EAN13	8425181 *
EXTRAS	Incluye orificio de drenaje de agua para aumentar la resistencia a la intemperie.
Medida Packaging (Al x An mm)	151x90

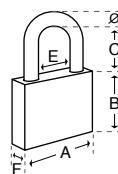

A-1313000



DESIGN FLOWERS



A-1313010



DESIGN SQUARES

REF.	A	B	C	Ø	E	F	NIVEL SEG.	UNID./CAJA	EAN	PRECIO
A-1313000	30 mm	28 mm	18 mm	5 mm	16 mm	14 mm	3	6	* 723463	2,77 €
A-1313010	30 mm	28 mm	18 mm	5 mm	16 mm	14 mm	3	6	* 723470	2,77 €



TSA ARCO FLEXIBLE

FICHA TÉCNICA

Cuerpo	Plástico.
Arco	Arco flexible de acero con recubrimiento de PVC.
Cierre de seguridad	TSA.
Mecanismo de apertura	Combinación de 3 discos. Código reprogramable.
Nivel de seguridad:	1 2 3 4 5
Código EAN13	8425181 *
EXTRAS	Homologado por la Agencia de Seguridad en el Transporte de EEUU.
Medida Packaging (Al x An mm)	152x90

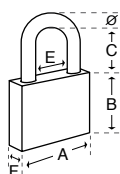

A-1313120

REF.	A	B	C	Ø	E	F	NIVEL SEG.	UNID./CAJA	EAN	PRECIO
A-1313120	31 mm	44 mm	55 mm	2,8 mm	13,4 mm	13 mm	3	6	* 732731	6,00 €

TSA COMBI

FICHA TÉCNICA

Cuerpo	Aleación de zinc con recubrimiento de plástico.
Arco	Acero cromado.
Cierre de seguridad	TSA.
Mecanismo de apertura	Combinación de 3 discos. Código reprogramable.
Nivel de seguridad:	1 2 3 4 5
Código EAN13	8425181 *
EXTRAS	Homologado por la Agencia de Seguridad en el Transporte de EEUU. Colores variados en la misma caja.
Medida Packaging (Al x An mm)	136x89

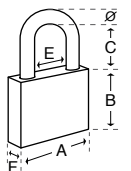

A-1313070



REF.	A	B	C	Ø	E	F	NIVEL SEG.	UNID./CAJA	EAN	PRECIO
A-1313070	26 mm	23,5 mm	16 mm	3,2 mm	14 mm	14,5 mm	3	6 (3 azul+3 negro)	* 727560	5,79 €

TSA LLAVE

FICHA TÉCNICA

Cuerpo	Aleación de zinc con recubrimiento de plástico.
Arco	Acero cromado.
Cierre de seguridad	TSA.
Mecanismo de apertura	2 llaves de serreta con recubrimiento de plástico.
Nivel de seguridad:	1 2 3 4 5
Código EAN13	8425181 *
EXTRAS	Homologado por la Agencia de Seguridad en el Transporte de EEUU. Colores variados en la misma caja.
Medida Packaging (Al x An mm)	136x89

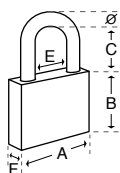

A-1313060



REF.	A	B	C	Ø	E	F	NIVEL SEG.	UNID./CAJA	EAN	PRECIO
A-1313060	30 mm	38,5 mm	18 mm	3,5 mm	11,5 mm	13 mm	3	6 (3 azul+3 negro)	* 727553	4,77 €

STRONG

FICHA TÉCNICA

Cuerpo	Candado rectangular con recubrimiento de acero.
Arco	Acero endurecido cromado.
Cierre de seguridad	Nivel alto.
Mecanismo de apertura	Cerradura de cilindro de 5 pines para una mayor resistencia.
Nivel de seguridad:	1 2 3 4 5
Código EAN13	8425181 *
Medida Packaging (Al x An mm)	190x135

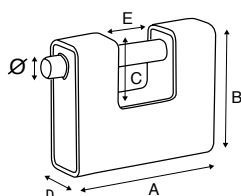

A-1313090



REF.	A	B	C	D	E	Ø	NIVEL SEG.	UNID./CAJA	EAN	PRECIO
A-1313090	90 mm	64 mm	36 mm	25 mm	35 mm	12 mm	4	6	* 728154	12,81 €

PORTA CANDADO

FICHA TÉCNICA

Material	Acero inoxidable
Nivel de seguridad:	1 2 3 4 5
Código EAN13	8425181 *

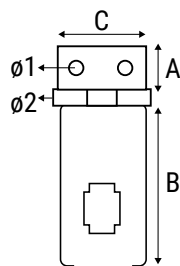

A-1313160



NEW

REF.	A	B	C	Ø1	Ø2	NIVEL SEG.	UNID./CAJA	EAN	PRECIO
A-1313160	29,2 mm	69,5 mm	37,3 mm	5,6 mm	9,2 mm	3	6	* 734414	4,46 €

CABLE MINI LOOP

FICHA TÉCNICA

Cable de acero con revestimiento de PVC.

Código EAN13	8425181 *
--------------	------------------



A-1313170



NEW

REF.	↔	Ø	UNID./CAJA	EAN	PRECIO
A-1313170	1000 mm	3 mm	6	* 734469	3,08 €

CABLES BICI COLORES

FICHA TÉCNICA

Descripción:

- Cable de acero con revestimiento plástico.
- Cerradura automática mediante un click.
- Llave serreta.

Código EAN13

8421316 *



Llave serreta
L-KBB18865LU



L-KBB18865B



L-KBB18865G



REF.	COLOR	↔	∅	UNIDADES CAJA	EAN	PRECIO
L-KBB18865LU	Blanco	650 mm	8 mm	30	* 059155	3,79 €
L-KBB18865B	Azul	650 mm	8 mm	30	* 059179	3,79 €
L-KBB18865G	Verde	650 mm	8 mm	30	* 059162	3,79 €

CABLE BICI BÁSICO

FICHA TÉCNICA

- Cable de acero con revestimiento plástico.
- Disponible embalaje "ready to sell"
- Llave serreta.

Código EAN13

8425181 *



Llave serreta



A-1320000

REF.	↔	∅	UNIDADES CAJA	EAN	PRECIO
A-1320000	600 mm	5 mm	6	* 727720	2,46 €

CABLE LOOP

FICHA TÉCNICA

- Cable de acero
- Terminales en forma de lazo
- **Combina LOOP con horquilla + soporte para conseguir mayor seguridad y comodidad**

Código EAN13

8421316 *



L-KBB12180LUM



REF.	↔	∅	UNIDADES CAJA	EAN	PRECIO
L-KBB12180LUM	1.800 mm	12 mm	1	* 052958	13,48 €

HORQUILLAS

FICHA TÉCNICA

- Cerradura de discos con llave reversible para mayor comodidad de apertura.
- Arco de acero cementado.

Código EAN13

8421316 *



Llave reversible



Horquilla mini de arco fijo
L-HOBMINB



Horquilla con soporte
L-KIT35BSOP



REF.		↑↓	↔	∅	UNIDADES CAJA	EAN	PRECIO
L-HOBMINB	Exterior	205 mm	140 mm	10 mm	4	* 048654	15,63 €
	Interior	170 mm	75 mm				
L-KIT35BSOP	Exterior	320 mm	180 mm	12 mm	4	* 068720	22,04 €
	Interior	274 mm	106 mm				

ESPIRALES BICI

FICHA TÉCNICA

- Cable de acero endurecido con revestimiento plástico
- Cerradura automática mediante un click.
- Llave serreta.

Código EAN13

8421316 *

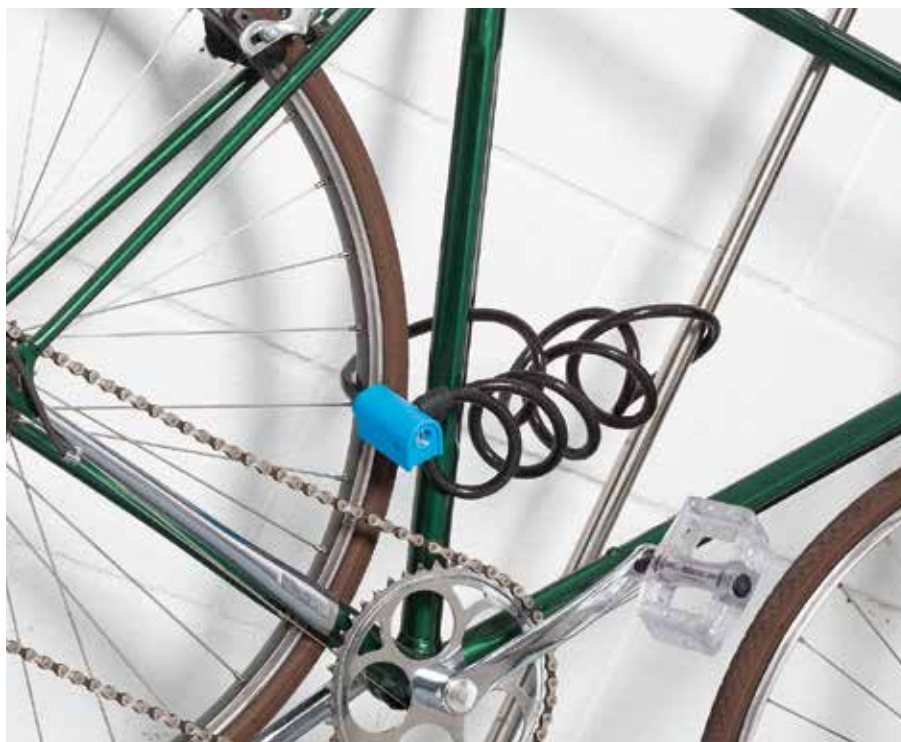

Ø8 mm.



L-ESB18818LU
LUMA



L-ESB18818B
LUMA



L-ESB18818G
LUMA

Ø10 mm.



L-ESB3410185B
LUMA



Llave serreta

REF.	COLOR	↔	Ø	UNIDADES CAJA	EAN	PRECIO
L-ESB18818LU	Blanco	1850 mm	8 mm	30	* 044410	4,61 €
L-ESB18818B	Azul	1850 mm	8 mm	30	* 051838	4,61 €
L-ESB18818G	Verde	1850 mm	8 mm	30	* 051845	4,61 €
L-ESB3410185B	Azul	1850 mm	10 mm	30	* 059230	9,58 €

ESPIRAL BICI CON SOPORTE



Llave serreta



FICHA TÉCNICA

- Cable de acero con revestimiento plástico.
- Llave serreta.
- Disponible en embalaje "ready to sell".

Código EAN13

8425181 *



A-1320100

REF.	←→	∅	UNIDADES CAJA	EAN	PRECIO
A-1320100	1500 mm	6	6	* 727713	2,92 €

ESPIRAL MATCH DE COMBINACIÓN

FICHA TÉCNICA

- Cable de acero con revestimiento plástico.
- Candado de combinación de 4 dígitos.
- Contraseña personalizable.

Código EAN13

8421316 *



L-ESC0815MCH



L-ESC1218MCH



REF.	←→	∅	UNIDADES CAJA	EAN	PRECIO
L-ESC0815MCH	1500 mm	8 mm	10	* 073083	9,38 €
L-ESC1218MCH	1850 mm	12 mm	10	* 073120	11,58 €

CADENA REVESTIMIENTO TEXTIL

FICHA TÉCNICA

- Cadena de acero templado con revestimiento textil.
- Cerradura de discos con llave reversible para mayor comodidad de apertura

Código EAN13

8421316 *



L-KDM0695ALB
LUMA



REF.	↔	∅	UNIDADES CAJA	EAN	PRECIO
L-KDM0695ALB	950 mm	6 mm	4	* 050206	27,37 €



Llave reversible



Cadena de acero endurecido



Pin de cierre en acero endurecido

CADENA

FICHA TÉCNICA

- Cadena de acero con revestimiento plástico.
- Llave serreta.
- Disponible en embalaje "ready to sell".

Código EAN13

8425181 *

REF.	↔	∅	UNIDADES CAJA	EAN	PRECIO
A-1320200	750 mm	5 mm	6	* 727737	5,13 €



A-1320200



Llave serreta

CADENA REVESTIMIENTO PLÁSTICO

FICHA TÉCNICA

- Cadena en acero templado con recubrimiento plástico.
- Llave serreta.

Código EAN13

8421316 *



Llave serreta



LUMA

L-KDM0590DEL



REF.	↔	∅	UNIDADES CAJA	EAN	PRECIO
L-KDM0590DEL	900 mm	5 mm	4	* 007873	13,79 €

ARTICULADO

FICHA TÉCNICA

- Cable protegido por rótulas de acero.
- Recubrimiento plástico.
- Llave reversible para mayor comodidad de apertura.

Código EAN13

8421316 *



Llave reversible



LUMA

LB-ARB7741LUM

LB-ARB7761LUM



REF.	↔	∅	UNIDADES CAJA	EAN	PRECIO
LB-ARB7741LUM	1000 mm	25 mm	25	* 044076	13,43 €
LB-ARB7761LUM	1500 mm	25 mm	15	* 044083	16,30 €

ANCLAJE ACERO

FICHA TÉCNICA

Código EAN13 **8421316 ***

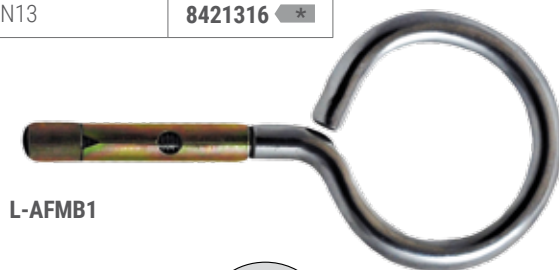

L-AFMB1

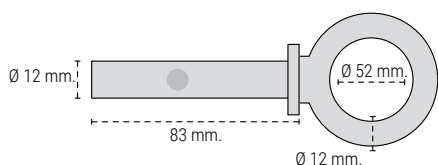

REF.	↔	Ø	UNIDADES CAJA	EAN	PRECIO
L-AFMB1	110 mm	52 mm	1	* 007231	20,65 €

DISCOS MOTO

FICHA TÉCNICA

- Cerradura de discos con llave reversible para mayor comodidad de apertura.
- Pintura anticorrosión.
- ENDURO 91D/ ENDURO 92 D incluyen funda de nylon para transportarlos con facilidad.

Código EAN13 **8421316 ***



Pin de cierre en acero endurecido



LB-DIB7301LUM

LB-DIB7401LUM



ENDURO 91D

ENDURO 92D



REF.	↔	↔	UNIDS/ CAJA	EAN	PRECIO
LB-DIB7301LUM	5 mm.	60 mm.	6	* 043994	16,35 €
LB-DIB7401LUM	5 mm.	20 mm.	6	* 044007	9,33 €
L-DIM91D	5 mm.	60 mm.	6	* 073736	27,68 €
L-DIM92D	5 mm.	20 mm.	10	* 073816	22,14 €



Llave reversible

INFLADOR BICI

FICHA TÉCNICA

Código EAN13 **8421316 ***



L-116333

REF.	↔	UNIDADES CAJA	EAN	PRECIO
L-116333	250 mm	1	* 070174	4,92 €

El producto incluye las abrazaderas y el racord para ambas válvulas.

ESPEJOS PARA SEGURIDAD Y VIGILANCIA

FICHA TÉCNICA

- Colocado en puntos estratégicos ayuda a minimizar posibles incidentes provocados por falta de visibilidad. Adecuados para la vigilancia de ángulos o zonas muertas en tiendas y supermercados, y para la seguridad vial en cruces y curvas peligrosas, salidas de garajes y espacios urbanos de reducida visibilidad.

- Resistente a la corrosión y al impacto

- Excelente calidad óptica.

- Puede ir fijado a pared o a un soporte. Incluye piezas de anclaje.

- Ángulo de visión máxima: 130°

Código EAN13

8425181 *



MIR000-30ø
* 726877
33,31 €

Material: Espejo convexo de policarbonato. Armazón de polipropileno color negro.



MIR001-45ø
* 724897
50,23 €

Material: Espejo convexo de policarbonato. Armazón de polipropileno color naranja.



MIR002-60ø
* 724903
80,98 €

Material: Espejo convexo de policarbonato. Armazón de polipropileno color naranja con visera protectora.



MIR003-80ø
* 724910
156,31 €

Material: Espejo convexo acrílico. Armazón de polipropileno color naranja con visera protectora.

SISTEMA DE FIJACIÓN A SOPORTE

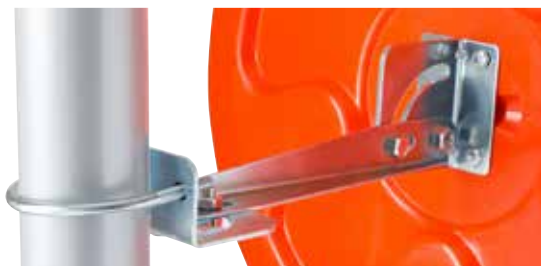

MIR000-30ø / MIR000-45ø



MIR000-60ø / MIR000-80ø

SISTEMA DE FIJACIÓN A PARED



MIR000-60ø / MIR000-80ø



MIR000-30ø / MIR000-45ø

BLOCKER

FICHA TÉCNICA

Material	Tubo de acero muy resistente.
Diseño	Barra de seguridad para bloquear puertas.
Versátil	Diseño versátil para puertas correderas y abatibles. Adaptable a diferentes alturas.
Fijación	Dispone de una junta esférica giratoria que mantiene la base de la barra en total contacto con el suelo ofreciendo una fijación totalmente estable y segura.
Código EAN13	8425181 *
Extras	Proporciona una seguridad adicional al hogar impidiendo la entrada de intrusos. La base de la barra es de goma a fin de evitar marcar el suelo y permitir su uso cotidiano. Abrazadera antirayaduras para proteger el pomo de la puerta.



SEG001



Para el uso en puertas correderas basta con extraer el perno, retirar la abrazadera y adecuar la barra al largo de la puerta.

Adecuado para bloquear puertas abatibles.



Retirando la abrazadera permite bloquear puertas correderas.



Referencia	SEG001
Medida Máxima / Mínima x Ø mm	1112 / 690 x 38.
Código EAN13	* 723340
PRECIO	22,55 €

ALARMAS PARA PUERTAS Y VENTANAS

FICHA TÉCNICA

Alarma sonora de 110dB altamente disuasoria. Con sensor magnético

No requiere retirarlo cuando no está en uso.

Funcionamiento	La alarma se activa cuando la puerta o ventana se abre.
Instalación	Mediante autoadhesivos. La alarma y el sensor se deben colocar en la puerta o ventana y el marco a la misma altura y a corta distancia.
Código EAN13	8425181 *
EXTRAS	Disponible un atractivo expositor de sobremesa con capacidad para 12 alarmas.



Al abrir la puerta la alarma se activa.



Referencia	AL-003
Medida exterior (Al x An x Al mm)	65x37x15.
Código EAN13	* 724408
PRECIO	4,41 €

EXPOSITOR

FICHA TÉCNICA

Disponibles un atractivo expositor de pie para exponer los productos de la gama de Seguridad Infantil que a continuación presentamos.

(Consultar condiciones)

Referencia	EXPOSITOR
Medidas (Al x An x F mm)	1800x510x200.



MALETIN DE SEGURIDAD INFANTIL

FICHA TÉCNICA

- Incluye 32 piezas:
- 8 protectores de esquinas
- 12 protectores de enchufe giratorios
- 4 topes de bisagra
- 2 cierres de seguridad multiusos largos
- 2 cierres de seguridad multiusos cortos
- 2 cierres de seguridad para armarios y vitrinas
- 2 esquineras.

Código EAN13 **8425181** *

REF.	EAN	PRECIO
A-1044210	* 727591	30,65 €



+ MALETIN DE REGALO



KIT DE PROTECCIÓN INFANTIL

FICHA TÉCNICA

- Incluye 13 piezas:
- 1 seguro para cajones
 - 1 tope para puerta
 - 4 protectores de esquinas
 - 5 protectores de enchufe giratorios
 - 2 cierres de seguridad multifunción

Código EAN13 **8412446** *



REF.	EAN	PRECIO
A-1044090	* 440906	6,97 €

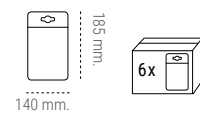

SEGURIDAD PARA PERSONAS PROTECCIÓN PARA ESQUINAS DE MOBILIARIO

Protege y minimiza los daños ante caídas o golpes accidentales contra cantos o esquinas.

ARREGUI

www.arregui.es

PERFIL PROTECTOR EN ROLLO

- Muy acolchado.
- Combinable con las esquineras A-1044250 y A-1044260.

Código EAN13 **8425181** *

REF.	COLOR	EAN	PRECIO
A-1044190	Blanco	* 726457	4,10 €
A-1044191	Marrón	* 727676	4,10 €



BLANCO
A-1044190



MARRÓN OSCURO
A-1044191

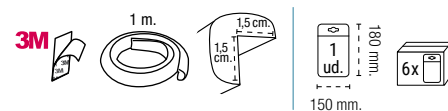

PERFIL PROTECTOR EN ROLLO MAXI

- Muy acolchado.
- Mayor anchura de producto para una mejor protección.
- Doble adherencia para una mayor fijación.
- Combinable con las esquineras ref. A-1044261 y A-1044262.

Código EAN13 **8425181** *

REF.	COLOR	EAN	PRECIO
A-1044340	Marrón	* 729007	6,15 €
A-1044341	Gris	* 731512	6,15 €



MARRÓN
A-1044340



GRIS
A-1044341

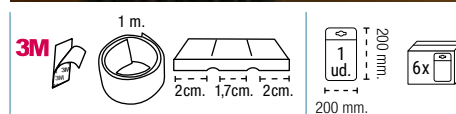
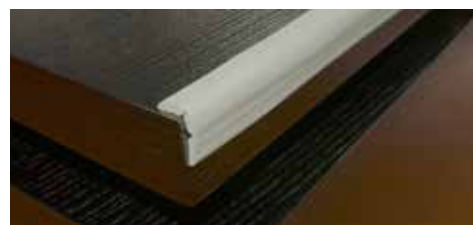

PROTECTOR ESQUINAS (4 UNIDS.)

FICHA TÉCNICA

- Muy acolchado.
- Combinable con los perfiles protectores A-1044190 / A-1044191 A-1044340 / A-1044341

Código EAN13 **8425181** *

REF.	COLOR	EAN	PRECIO
A-1044250	Blanco	* 727683	3,49 €
A-1044260	Marrón O	* 727690	3,49 €
A-1044261	Marrón	* 731499	3,49 €
A-1044262	Gris	* 731505	3,49 €



COLOR
BLANCO
A-1044250



COLOR
MARRÓN
OSCURO
A-1044260



COLOR
MARRÓN
A-1044261



COLOR GRIS
A-1044262

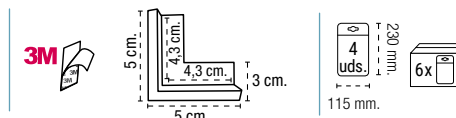

PROTECTOR ESQUINAS (4 UNIDS.)

Código EAN13

8412446 *



TRANSPARENTE
A-1044030



COLOR BLANCO
A-1044031



COLOR MARRÓN
A-1044032

REF.	COLOR	EAN	PRECIO
A-1044030	Transp.	* 440302	2,36 €
A-1044031	Blanco	* 728833	2,36 €
A-1044032	Marrón	* 731475	2,36 €

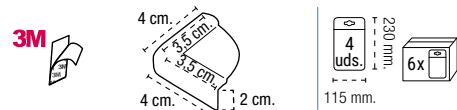

PROTECTOR ESQUINAS MAXI (4 UNIDS.)

Código EAN13

8425181 *

Esquinera de gran tamaño para una mejor protección.

Mayor superficie de adherencia para una mayor sujeción.



A-1044330

REF.	EAN	PRECIO
A-1044330	* 728826	3,59 €

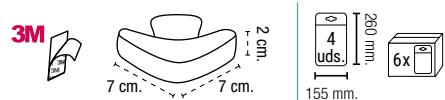

PROTECTOR ESQUINAS OSO / GATO (2 UNIDS.)

Código EAN13

8425181 *



MOD.: OSO
A-1044400



MOD.: GATO
A-1044401



REF.	MODELO	EAN	PRECIO
A-1044400	Oso	* 731574	7,07 €
A-1044401	Gato	* 731581	7,07 €

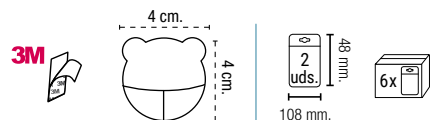

SEGURIDAD PARA PERSONAS PROTECCIÓN ESQUINAS Y CANTOS DE PARED

Protege y minimiza los daños ante caídas accidentales y preserva la pared de roces o golpes.

ARREGUI

www.arregui.es

BANDA PROTECTORA

Código EAN13 **8425181** *



A-1044300



A-1044301



A-1044304

Bandas protectoras de doble uso:

- Válidas para colocar en los cantos de las columnas, gracias al hendido que facilita su fijación a cualquier pared.
- También se pueden instalar en plano para proteger la pared de roces y golpes.



La banda tiene un hendido para doblarla fácilmente y colocarla en esquinas.

REF.	COLOR	EAN	PRECIO
A-1044300	Blanco	* 728796	10,15 €
A-1044301	Azul	* 731383	10,15 €
A-1044304	Fresa	* 731413	10,15 €

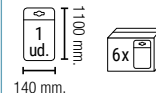
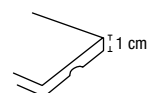
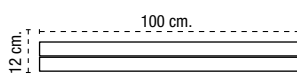

PROTECTOR DE CANTOS Y ESQUINAS

Esquinera válida para cualquier pared, muy discreta gracias a su material transparente.

Código EAN13 **8425181** *



A-1044310

REF.	EAN	PRECIO
A-1044310	* 731437	10,15 €

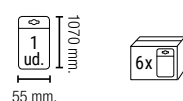
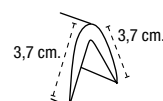
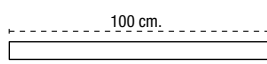

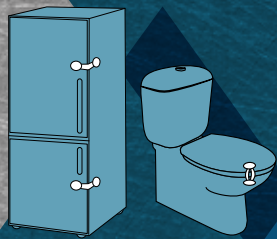

SEGURIDAD PARA PERSONAS CIERRES DE SEGURIDAD MULTIUSOS

Útiles para evitar que los niños abran el frigorífico, la tapa del WC o aquellos armarios que puedan contener materiales peligrosos.

CIERRE REGULABLE (2 UNIDS.)

Cómodo y fácil de desbloquear por un adulto. Ideal para muebles o electrodomésticos de uso habitual.

Se puede cortar a la medida necesaria.

Gracias a su sistema de apertura resiste más que otros cierres, ya que sufre menos deterioro con el uso.

Código EAN13 **8425181** *



A-1044350

REF.	EAN	PRECIO
A-1044350	* 728871	3,49 €

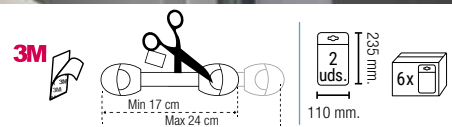

CIERRE MULTIUSOS CORTO (2 UNIDS.)

Código EAN13 **8425181** *



A-1044110

REF.	EAN	PRECIO
A-1044110	* 721117	1,79 €

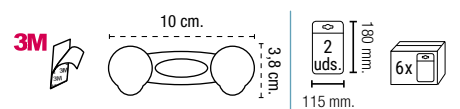

CIERRE MULTIUSOS LARGO

Código EAN13 **8412446** *



A-1044070

REF.	EAN	PRECIO
A-1044070	* 440708	1,38 €

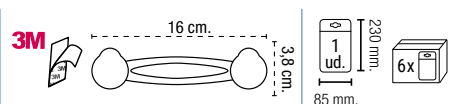

SEGURIDAD PARA PERSONAS PROTECCIÓN PARA ENCHUFES

Evita que se puedan insertar objetos o dedos en los enchufes, eliminando accidentes con la corriente.

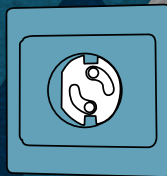

ARREGUI

www.arregui.es

PROTECTOR ENCHUFES GIRATORIO (10 UNIDS.)

No es necesario quitarlo para utilizar la toma de corriente.

Código EAN13

8412446 *

REF.	EAN	PRECIO
A-1044050	* 440500	3,28 €



A-1044050

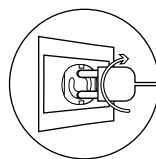

PROTECTOR ENCHUFES FIJO (10 UNIDS.)

Es necesario retirarlo cada vez que se quiera utilizar la toma de corriente.

Código EAN13

8412446 *

REF.	EAN	PRECIO
A-1044060	* 440609	1,79 €



A-1044060



PROTECCIÓN PARA ARMARIOS

Para evitar que los niños abran los armarios y vacíen o rompan su contenido

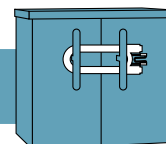

CIERRE DE SEGURIDAD

Código EAN13

8412446 *

REF.	EAN	PRECIO
A-1044040	* 440401	1,54 €



A-1044040

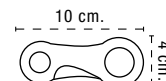

HORQUILLA DE SEGURIDAD

Código EAN13

8412446 *

REF.	EAN	PRECIO
A-1044080	* 440807	1,54 €



A-1044080

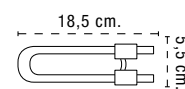
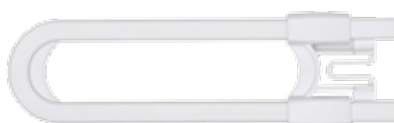



LIMITADOR APERTURA VENTANAS CORREDERAS MARIPOSA (4 UNIDS.)

Se pega en el cristal de la hoja fija de la ventana. Con el limitador en posición plana, la hoja pasará por encima permitiendo el cierre.

Con el limitador en su posición normal, la hoja de la ventana hará tope contra las alas, limitando su apertura.

Código EAN13	8425181 *	
REF.	EAN	PRECIO
A-1044370	* 728949	2,56 €



A-1044370

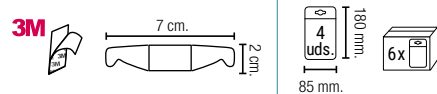

LIMITADOR APERTURA VENTANAS CORREDERAS VENTOSA

Código EAN13	8425181 *	
--------------	------------------	--

REF.	EAN	PRECIO
A-1044120	* 721124	1,79 €



A-1044120

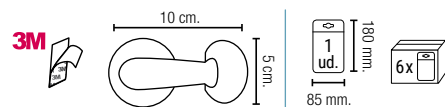
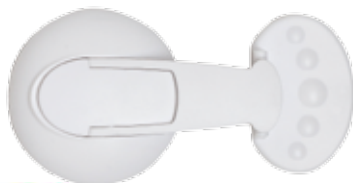

LIMITADOR APERTURA VENTANAS CORREDERAS METALICOS (4 UNIDS.)

Se recomienda colocar los limitadores alineados en la guía del canal superior e inferior de la ventana. Fijar fuertemente el tornillo del limitador.

Válido para un grosor máximo de guías de 9 mm.

Código EAN13	8425181 *	
REF.	EAN	PRECIO
A-1044170	* 724682	5,64 €



A-1044170

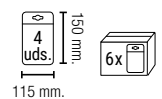

RECOGEDOR CUERDA PARA CORTINAS Y ESTORES (2 UNIDS.)

Permite enrollar en su interior las cuerdas de las cortinas hasta dejarlas a la medida deseada, para evitar que los niños tiren de ellas o sufran accidentes.

Código EAN13	8425181 *	
REF.	EAN	PRECIO
A-1044380	* 728918	2,46 €



A-1044380



SEGURIDAD PARA PERSONAS PROTECCIÓN PARA PUERTAS

Para evitar que los niños se pillen los dedos.



www.arregui.es

SALVADEDOS

Se fijan a presión en el canto de la puerta, evitando que la puerta se cierre completamente.



COLOR BLANCO
A-1044010



MODELO OSO
A-1044011



REF.	EAN	PRECIO
A-1044010	8412446440111	1,54 €
A-1044011	8425181729021	2,00 €

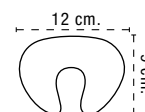

TOPE PUERTA

Código EAN13

8425181 *



Embalaje
"ready to sell"
A-1044290



REF.	EAN	PRECIO
A-1044290	* 728529	1,23 €

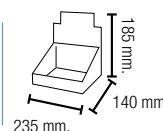
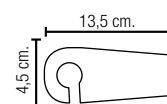



PROTECTOR FLEXIBLE DE BISAGRAS

Se coloca cubriendo las bisagras y permite la apertura y cierre normal de la puerta, evitando que los niños puedan introducir y pillarse los dedos.

Una vez instalado el producto, la puerta se abre un máximo de 110°.

Material transparente.

Código EAN13

8425181 *



A-1044320

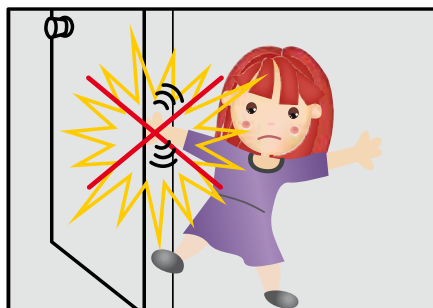

REF.	EAN	PRECIO
A-1044320	* 731420	10,76 €

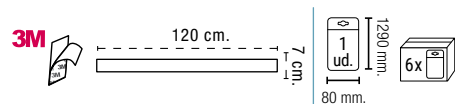

TOPE BISAGRAS (2 UNIDS.)

El tope se cuelga de la bisagra impidiendo que la puerta se pueda cerrar. Dispone de soporte para colocar el tope cuando no esté en uso..

Código EAN13

8425181 *



A-1044180



REF.	EAN	PRECIO
A-1044180	* 724781	2,31 €



SEGURIDAD PARA PERSONAS PROTECCIÓN PARA CAJONES

Evita que los niños puedan abrir los cajones y se dañen o manipulen su contenido.



www.arregui.es

CIERRE MAGNÉTICO

Cierre magnético invisible. El pomo solo se apoya sobre la puerta o cajón en el momento de la apertura, desbloqueando automáticamente el cierre de seguridad.

Disponible en packs de:
- Completo: pomo + 1 cierre
- Solo pomo
- Solo 2 cierres.



Código EAN13 **8425181** *



A-1044360



A-1044361



A-1044362

REF.	DESCRIPCIÓN	EAN	PRECIO
A-1044360	Pomo + 1 cierre	* 728932	7,69 €
A-1044361	Pomo	* 731543	5,13 €
A-1044362	2 Cierres	* 723562	5,13 €

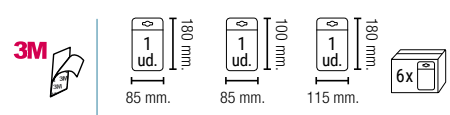

CIERRE CAJONES ESQUINEROS

Código EAN13 **8412446** *



A-1044000



REF.	EAN	PRECIO
A-1044000	* 440012	1,54 €

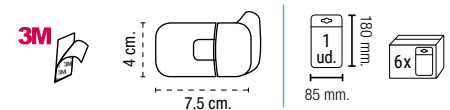

CIERRE CAJONES (8 UNIDS.)

Código EAN13 **8425181** *



A-1044130



REF.	EAN	PRECIO
A-1044130	* 721131	3,28 €

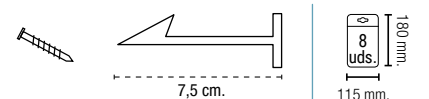

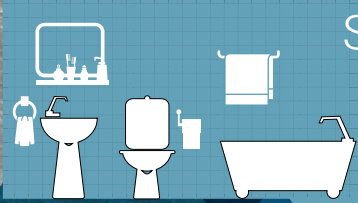

ADAPTADOR PARA WC

- Asiento reductor para WC.
- Antideslizante
- Plegable

Código EAN13 **8425181** *



A-1044390

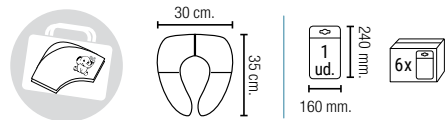

REF.	EAN	PRECIO
A-1044390	728895	11,28 €

PROTECTOR GRIFO BANERA

Código EAN13 **8425181** *



A-1044150

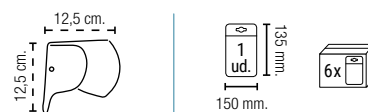

REF.	EAN	PRECIO
A-1044150	724668	7,07 €

ANTIDESLIZANTE BAÑERA

Protege a los niños de resbalones y caídas durante el baño.

Código EAN13 **8425181** *



A-1044141



A-1044140

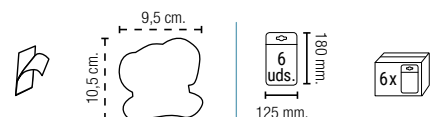

REF.	MODELO	EAN	PRECIO
A-1044141	Elefante	728925	2,97 €
A-1044140	Huella	721148	2,97 €

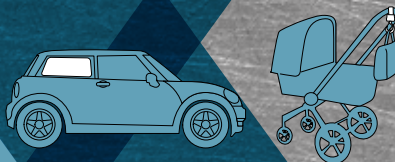

ESPEJO RETROVISOR

Permite supervisar durante la conducción a los ocupantes del asiento trasero del automóvil.

Dispone de articulación esférica ajustable, para un enfoque perfecto.

Código EAN13 **8425181** *



A-1044200

REF.	EAN	PRECIO
A-1044200	* 727133	2,97 €

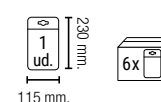
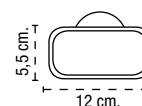

KIT COCHE

Código EAN13 **8425181** *



A-1044280



Espejo retrovisor infantil.

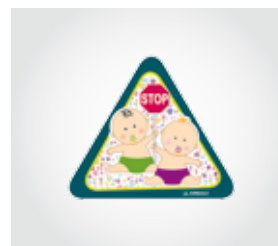

Adhesivo "bebé a bordo".



2 parasoles.

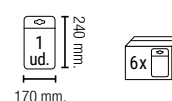
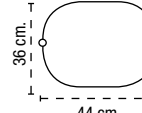
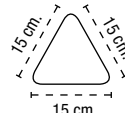
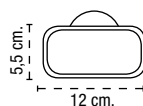

REF.	EAN	PRECIO
A-1044280	* 727744	6,66 €

GANCHO PARA SILLA (2 UNIDS.)

Ganchos giratorios para colocar en coches de bebé, sillas de paseo...

Permiten colgar bolsas de hasta 3 kg

Sujeción mediante cinta con cierre textil.

Código EAN13 **8425181** *



A-1044270

REF.	EAN	PRECIO
A-1044270	* 727706	6,66 €

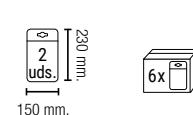
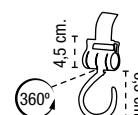

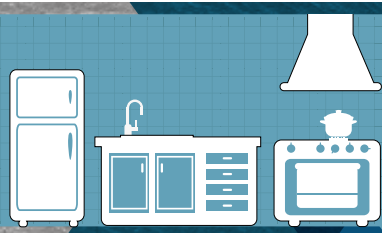

PROTECTOR MANDOS DE COCINA (2 UNIDS.)

Evita que los niños manipulen los mandos de la cocina, previniendo fugas de gas, quemaduras o accidentes peligrosos.

Código EAN13 **8425181** *



A-1044160

REF.	EAN	PRECIO
A-1044160	* 724675	2,31 €

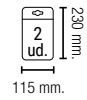
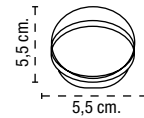

PROTECCIÓN DORMITORIO

BARRERA DE CAMA

Cumple la Normativa BS7972 + EN71-3

Abatible y de fácil instalación.

Permite un acceso cómodo para hacer la cama sin retirar la barrera

Código EAN13 **8425181** *

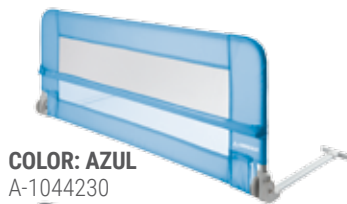

COLOR: AZUL
A-1044230



COLOR: GRIS
A-1044220

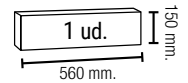
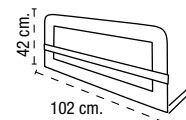

REF.	COLOR	EAN	PRECIO
A-1044220	Gris	* 727607	29,21 €
A-1044230	Azul	* 727614	29,21 €

ALFOMBRA PUZZLE

CE UNE EN 71-1/2/3

- 100% goma EVA, no tóxico.
- Lavable
- Superficie total: 1 m².
- Contiene 10 piezas

Código EAN13 **8425181** *



A-1044240

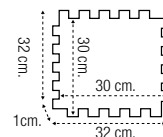

REF.	EAN	PRECIO
A-1044240	* 727621	15,89 €

CINTA ANTIDESLIZANTE COLOR NEGRO

FICHA TÉCNICA

Unidades / envase	1
Unidades compra mínima	6 Envases
Descripción: Proporciona seguridad en todas aquellas zonas que por sus características, pueden provocar resbalones y caídas.	
Código EAN13	8425181 *



A-1050050

NEW

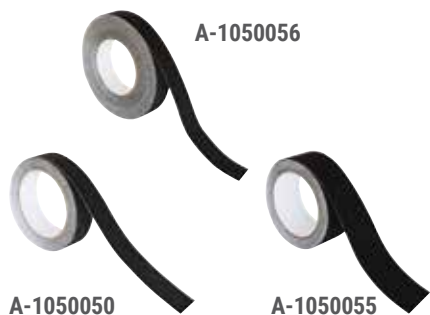

A-1050050

A-1050055

Referencia	A-1050050	A-1050055	A-1050056
Medidas (Long. x Anch.)	5m x 25mm	5m x 40mm	15m x 25mm
Medida Packaging (Al x An x F mm)	135x105x25.	135x105x44	183x145x27
Código EAN13	* 726693	* 734445	* 734452
PRECIO	2,67 €	3,95 €	6,56 €

CINTA ANTIDESLIZANTE TRANSPARENTE

FICHA TÉCNICA

Unidades / envase	1
Unidades compra mínima	6 Envases
Descripción: Proporciona seguridad en todas aquellas zonas que por sus características, pueden provocar resbalones y caídas.	
Código EAN13	8425181 *



A-1050051

NEW



A-1050051

Referencia	A-1050051
Medidas (Long. x Anch.)	5m x 25mm
Medida Packaging (Al x An x F mm)	143x105x27
Código EAN13	* 734421
PRECIO	2,97 €

CINTA ANTIDESLIZANTE AMARILLA Y NEGRA

FICHA TÉCNICA

Unidades / envase	1
Unidades compra mínima	6 Envases
Descripción: Proporciona seguridad en todas aquellas zonas que por sus características, pueden provocar resbalones y caídas.	
Código EAN13	8425181 *



A-1050052



A-1050052



Referencia	A-1050052
Medidas (Long. x Anch.)	5m x 25mm
Medida Packaging (Al x An x F mm)	144x112x27
Código EAN13	* 734438
PRECIO	2,97 €

CINTA LUMINISCENTE

FICHA TÉCNICA

Unidades / envase	1
Unidades compra mínima	6 Envases
Descripción: Proporciona seguridad al brillar en la oscuridad y alertar de zonas que pueden ser peligrosas: escalones, puertas, escaleras, pasamanos, etc.	
Código EAN13	8425181 *



A-1050061



A-1050060



Referencia	A-1050060	A-1050061
Medidas (Long. x Anch.)	5m x 20mm	5m x 40mm
Medida Packaging (Al x An x F mm)	135x105x25	142x118x45
Código EAN13	* 726709	* 734476
PRECIO	5,95 €	9,23 €

BRAZALETE REFLECTANTE DE AJUSTE AUTOMÁTICO

FICHA TÉCNICA

Unidades / envase	1
Unidades compra mínima	6 Envases
Medida Packaging (Al x An mm)	358x44
Código EAN13	8425181 * *

NEW



BRAZALETE REFLECTANTE DE AJUSTE AUTOMÁTICO

A-1050150
* 734483

3,59 €



BRAZALETE REFLECTANTE CON LUZ LED

FICHA TÉCNICA

Unidades / envase	1
Unidades compra mínima	6 Envases
Dispone de 2 posiciones de luz, fija e intermitente.	
Medida Packaging (Al x An mm)	315x55
Código EAN13	8425181 * *

NEW



BRAZALETE REFLECTANTE CON LUZ LED A-1050160

* 734490

6,10 €



LUPA DE BOLSILLO CON LED

FICHA TÉCNICA

Unidades / envase	1
Unidades compra mínima	12 Envases
Descripción: Con formato de tarjeta de crédito es adecuado para llevarlo fácilmente en el bolsillo. 2 áreas de aumento (3x y 6x). Incorpora una lámpara LED blanca.	
Medida Packaging (Al x An mm)	105x60x10
Código EAN13	8425181 * *



LUPA DE BOLSILLO CON LED

A-1050120

* 726846

4,46 €



PINZA DE ALCANCE

FICHA TÉCNICA

Unidades / envase	1
Unidades compra mínima	6 Envases
<p>Descripción: Permite recoger objetos del suelo o a distancia sin necesidad de agacharse. Cabeza giratoria con pinza antideslizante e imán para recoger pequeños objetos metálicos.</p>	
Medida Packaging (Al x An mm)	785x140x45
Código EAN13	8425181 *



PINZA DE ALCANCE
A-1050030
* 726679
8,20 €



LOCALIZADOR DE OBJETOS

FICHA TÉCNICA

Unidades / envase	3
Unidades compra mínima	1 Envase
<p>Descripción: Facilita la búsqueda rápida de llaves u objetos que fácilmente pueden extraviarse. Formado por 3 llaveros y un control remoto. Al presionar el control remoto el llavero emite una señal acústica de 80dB durante 4 segundos para facilitar su búsqueda.</p>	
Medida Packaging (Al x An mm)	210x140x20
Código EAN13	8425181 *



LOCALIZADOR DE OBJETOS
A-1050100
* 726747
25,63 €



COJÍN GIRATORIO

FICHA TÉCNICA

Unidades / envase	1
Unidades compra mínima	1 Envase
Descripción: Formado por 2 discos giratorios con base antideslizante, permite girar fácilmente para adoptar la posición ideal para levantarse o sentarse. Idónea para su uso en el coche, en la cama o cualquier tipo de asiento.	
Medida Packaging (Al x An x F mm)	455x215x50
Código EAN13	8425181 *



COJÍN GIRATORIO A-1050110
* 726839
15,73 €



ASIDERO PORTÁTIL CON VENTOSA

FICHA TÉCNICA

Unidades / envase	1
Unidades compra mínima	6 Envases
Descripción: Proporciona seguridad y apoyo para aquellas personas con problemas de movilidad. Se adhiere a superficies planas. Ideal para vidrio y azulejos.	
Medida Packaging (Al x An x F mm)	123x107x107
Código EAN13	8425181 *



ASIDERO PORTÁTIL CON VENTOSA A-1050040
* 726686
5,79 €



ABRIDOR UNIVERSAL

FICHA TÉCNICA

Unidades / envase	1
Unidades compra mínima	6 Envases
Descripción: Diseñado para adaptarse prácticamente a cualquier tamaño de tapa o tapón. Permite abrir frascos y botellas con facilidad.	
Medida Packaging (Al x An x Al mm)	260x115x25
Código EAN13	8425181 *



ABRIDOR UNIVERSAL A-1050140
* 726860
4,61 €



ALARMAS PERSONALES

FICHA TÉCNICA

Alarmas personales contra ataques.

Altamente disuasorias:	Alarmas sonoras de gran potencia que pueden ser oídas a gran distancia.
Cómoda	Su tamaño reducido facilita llevarla siempre a mano.
Código EAN13	8425181 *



Funcionamiento: La alarma se activa tirando del cordón.



AL-001

Referencia	AL-001
Medida exterior (Al x An x F mm)	67x38x24
Código EAN13	* 724385
Extras	Incorpora un detector de movimiento. Posicionándola verticalmente sobre una superficie y activando el sensor, el dispositivo activará la alarma en caso de que detecte cualquier movimiento en el campo de acción.
PRECIO	9,23 €



Los 3 modelos incorporan una linterna LED de alta intensidad.



Funcionamiento: La alarma se activa presionando los 2 laterales.



AL-002

Referencia	AL-002
Medida exterior (Al x An x F mm)	75x40x12
Código EAN13	* 724392
Extras	Su formato permite llevarla en el bolsillo y tenerla siempre a mano.
PRECIO	6,00 €



Funcionamiento: La alarma se activa tirando del cordón y extrayendo el seguro.



AL-004

Referencia	AL-004
Medida exterior (Al x An x F mm)	65x40x27 mm
Código EAN13	* 724415
Extras	Incluye un clip para llevar la alarma enganchada en la cintura.
PRECIO	9,23 €



Disponible un atractivo expositor de sobremesa con capacidad para 12 alarmas.

BOTIQUÍN

FICHA TÉCNICA

Material	Acero lacado.
Apertura	Mediante llave de serreta.
Diseño	Diseñada con dibujos contemporáneos.
Práctico	Disponen de una balda separadora que permite almacenar los medicamentos aprovechando el máximo espacio.
Código EAN13	8425181 *

PACKAGING (mm)

<p>PACKAGING 365x325x110</p>	
---	--



RING
BT001-1

Referencia	BT001-1
Medida exterior (Al x An x F mm)	360x315x100
Código EAN13	* 200032
PRECIO	28,70 €



Permiten guardar bajo llave y organizar bien los medicamentos.



RECICLAJE Y ORDEN

 **ARREGUI**

www.arregui.es



BASIC



FICHA TÉCNICA

Material:	Cuerpo y frente de acero lacado.
Práctico:	Destinados a la recogida selectiva de residuos domésticos: papel, vidrio, envases, orgánicos.
Instalación:	Dispone de 3 agujeros de fijación en la parte trasera. Se recomienda su fijación a pared.
Capacidad:	Disponibles con 2, 3 y 4 compartimentos, en el que se alojan 1 o 2 cubetas de plástico removibles y con asas que facilitan su extracción y limpieza. Cada cubeta tiene una capacidad de 17 L.
Sistema de apertura:	Basculante. La apertura de cada cajón se realiza independientemente.
Código EAN13	8425181 *

EXTRAS

· Disponible un pack de 15 bolsas de basura de tamaño adecuado para las cubetas del contenedor.



BASIC 2 BLANCO
2 CUBETAS
CR201-B

BASIC 3 BLANCO
3 CUBETAS
CR301-B

BASIC 4 BLANCO
4 CUBETAS
CR601-B

BASIC 2 GRIS
2 CUBETAS
CR202-B

BASIC 3 GRIS
3 CUBETAS
CR302-B

BASIC 4 GRIS
4 CUBETAS
CR602-B



BOLSAS DE BASURA CR001

* 722879

1,44 €



El cuerpo enmarca el frontal del contenedor.



Se integra fácilmente en la decoración de cualquier cocina.

Referencia	CR201-B	CR202-B	CR301-B	CR302-B	CR601-B	CR602-B
Número de cubetas	2		3		4	
Color	Blanco	Gris	Blanco	Gris	Blanco	Gris
Medida exterior (Al x An x F) mm.	905x305x245		1335x305x245		905x585x245	
Peso	10,5Kg.		13,9Kg.		16,7Kg.	
Volumen	34L.		51L.		68L.	
Código EAN13	* 720417	* 720424	* 721575	* 721582	* 720455	* 720462
Medida Packaging (Al x An x F) mm.	965x370x310		1400x370x310		965x690x325	
PRECIO	107,63€		142,48€		153,75€	

VARIO



FICHA TÉCNICA

Material:	Cuerpo de acero lacado y frente de acero inoxidable.
Práctico:	Destinados a la recogida selectiva de residuos domésticos: papel, vidrio, envases, orgánicos.
Instalación:	Dispone de 3 agujeros de fijación en la parte trasera. Se recomienda su fijación a pared.

Capacidad

Disponibles con 2, 3 y 4 compartimentos, con cubetas de plástico removibles y con asas que facilitan su extracción y limpieza.

Cada cubeta tiene una capacidad de 16 L.

Sistema de apertura:	Basculante En el contenedor de 2 y 3 cajones la apertura de los cajones se efectúa simultáneamente
----------------------	---

Código EAN13 8425181 *

EXTRAS

El frontal de acero inoxidable cubre el cuerpo en su totalidad y es ideal para su instalación integrada entre los muebles y electrodomésticos de cocina.

Disponible un pack de 15 bolsas de basura de tamaño adecuado para las cubetas del contenedor.

La resistencia del material inoxidable lo hace adecuado para su colocación en terrazas y balcones exteriores.



BOLSAS DE BASURA

CR001

* 722879

1,44 €



VARIO 2
2 CUBETAS
CR-205



VARIO 3
3 CUBETAS
CR-305



VARIO 4
4 CUBETAS
CR-605

Referencia	CR-205	CR-305	CR-605
Número de cubetas	2	3	4
Medida exterior (Al x An x F)	895x316x250 mm.	1335x316x250 mm.	910x580x250 mm.
Peso	12,7 kg.	17,3 kg.	20 kg.
Volumen	32 L.	48 L.	64 L.
Código EAN13	* 719923	* 719992	* 720387
Medida Packaging (Al x An x F)	965x370x310 mm.	1400x370x310 mm.	1040x690x325 mm.
PRECIO	155,80€	201,93€	215,25€



El frente de acero inoxidable cubre el cuerpo de acero en su totalidad.



Ideal para su colocación entre los muebles de cocina y electrodomésticos.

STEP BIN

FICHA TÉCNICA

Material:	Acero inoxidable y polipropileno.
Práctico:	Destinados a la recogida selectiva de residuos domésticos.
Capacidad:	Disponibles con 2 y 3 compartimentos con cubetas de plástico removibles y con asas que facilitan su extracción y limpieza. Cada cubeta tiene una capacidad de 15 L. Permite identificar el tipo de residuo a depositar en cada cubeta mediante el color del pedal.
Sistema de apertura:	Mediante pedal.
Código EAN13	8425181 *



Ref.
CR705-45L



Ref.
CR705-30L

	CR705 30L	CR705 45L
Referencia	CR705 30L	CR705 45L
Medida exterior (Al x An x F)	485x410x340 mm.	485x605x340 mm.
Peso	4,5Kg.	6,5Kg.
Volumen	30 L.	45 L.
Código EAN13	* 724279	* 724262
Medida Packaging (Al x An x F)	510x430x370 mm.	510x625x370 mm.
PRECIO	62,53€	89,69€



Cubetas con asas que facilitan su extracción y limpieza.



Apertura mediante pedal.

TABURETE PLEGABLE

FICHA TÉCNICA

Material: Polipropileno de alta resistencia. Incluye puntos antideslizantes de goma.

Cómodo y manejable: Se pliega totalmente con un solo movimiento y dispone de asa para transportarlo. Puede guardarse en cualquier rincón de la vivienda, trastero, caravana...

Resistencia: Soporta hasta 150 kg de peso.

Código EAN13 **8425181** *



NEW



Ref. **TB-027-D1**



NEW



Ref. **TB-032-D1**

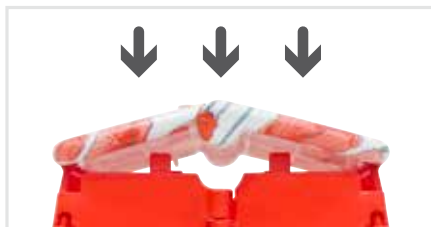

REF.	COLOR	MEDIDA EXTERIOR (Al x An x F mm)	PESO	CARGA	EAN13	PRECIO
TB-027-D1	Amapola	270x290x220 mm	1,16 kg	150 KG	* 734704	11,02 €
TB-032-D1	Amapola	320X290X220 mm	1,46 kg	150 KG	* 734711	12,45 €



Resistencia de 150 kg.

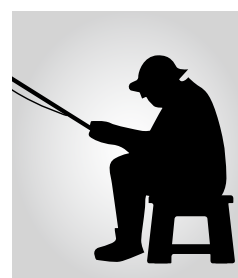
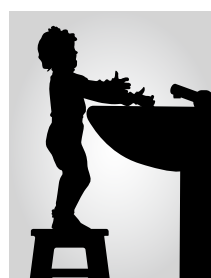

Adecuado para múltiples usos domésticos.

TABURETE PLEGABLE

FICHA TÉCNICA

Material: Polipropileno de alta resistencia. Incluye puntos antideslizantes de goma.

Cómodo y manejable: Se pliega totalmente con un solo movimiento y dispone de asa para transportarlo. Puede guardarse en cualquier rincón de la vivienda, trastero, caravana...

Resistencia: Soporta hasta 150 kg de peso.

Código EAN13 8425181 *

EXTRAS
El taburete de 39 cm de alto es idóneo para su uso como asiento para campistas, pescadores...

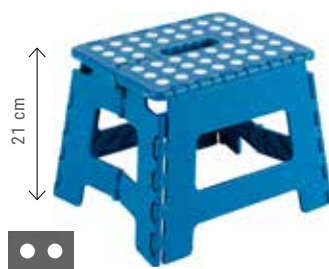

TB-021-G

TB-021-A

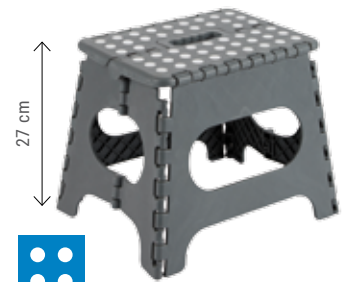

TB-027-A

TB-027-G

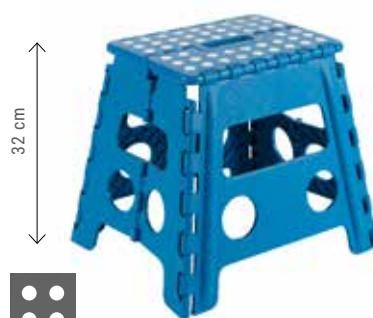

TB-032-G

TB-032-A



TB-039-A

TB-039-G



El tamaño TB-021 se suministra en un atractivo expositor con 10 unidades.

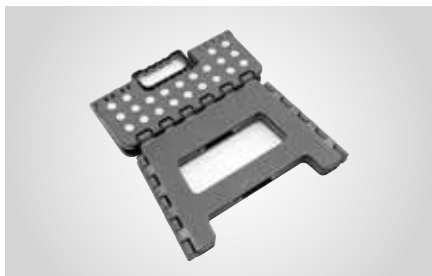

Plegable.

REF.	COLOR	MEDIDA EXTERIOR (Al x An x F mm)	PESO	CARGA	EAN13	PRECIO
TB-021-G	Gris	210x250x200 mm	0,67 kg	150 KG	* 724309	6,71 €
TB-021-A	Azul				* 724316	
TB-027-G	Gris	270x290x220 mm	1,16 kg	150 KG	* 724323	8,97 €
TB-027-A	Azul				* 724330	
TB-032-G	Gris	320x290x220 mm	1,46 kg	150 KG	* 724347	10,40 €
TB-032-A	Azul				* 724354	
TB-039-G	Gris	390x290x220 mm	1,52 kg	150 KG	* 724361	11,74 €
TB-039-A	Azul				* 724378	11,74 €



Resistencia de 150 kg.



Adecuado para múltiples usos domésticos.

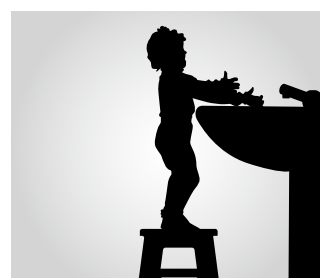

D-ACS01

FICHA TÉCNICA

Material	Aluminio
Bordes redondeados y reforzados	
Asa cromada con recubrimiento plástico.	
Compartimentos internos extraíbles.	
Cubierta interior con espacios para destornilladores, alicates, llaves, etc.	
Color:	Plata
Cierre:	Cerradura de combinación.
Código EAN13	8019635 *



PACKAGING



Referencia	D-ACS01
Medida exterior (Al x An x F)	155x400x280 mm
Código EAN13	* 900007
Medida Packaging (Al x An x F)	155x400x280 mm
PRECIO	33,83 €

D-ACS04

FICHA TÉCNICA

Material	Aluminio, con 5 compartimentos.
Bordes redondeados y reforzados	
Asa cromada con recubrimiento plástico.	
Correa tipo bandolera.	
Color:	Plata
Cierre:	Cerradura de llave.
Código EAN13	8019635 *



PACKAGING



Referencia	D-ACS04
Medida exterior (Al x An x F)	260x320x210 mm
Código EAN13	* 900014
Medida Packaging (Al x An x F)	260x320x210 mm
PRECIO	36,90 €

D-ACS06

FICHA TÉCNICA

Material	Aluminio y ABS.
Bordes redondeados con elegantes apliques de acero cromado.	
Asa cromada con recubrimiento plástico.	
Fondo con 6 compartimentos extraíbles.	
3 bisagras de acero.	
2 paneles para herramientas con bolsillo incorporado para documentos.	
4 patas de goma.	
Color:	Burdeos
Cierre:	2 cerraduras de acero cromado con llave.
Código EAN13	8019635 *



PACKAGING



Referencia	D-ACS06
Medida exterior (Al x An x F)	185x466x351mm
Código EAN13	* 900212
Medida Packaging (Al x An x F)	185x466x351 mm
PRECIO	72,78 €

D-ACP01

FICHA TÉCNICA

Material	Aluminio.
Bordes redondeados y reforzados.	
Panel interior extraíble con espacios para destornilladores, alicates, llaves, etc.	
Correa tipo bandolera.	
Color:	Plata
Cierre:	Cerradura de acero cromado con llave.
Código EAN13	8019635 *



PACKAGING



Referencia	D-ACP01
Medida exterior (Al x An x F)	152x455x330 mm
Código EAN13	* 900021
Medida Packaging (Al x An x F)	152x455x330 mm
PRECIO	35,88 €

CAJA DE HERRAMIENTAS CPM

FICHA TÉCNICA

Estructura robusta realizada en lámina de acero de 0,6 mm de espesor.

Espesor del asa de 1 mm. y 18 mm. diámetro.

Tapa con orificios para cierre con candado.

Código EAN13

8019635 *

PACKAGING



D-CPM03



D-CPM05



D-CPM05L



	D-CPM03	D-CPM05	D-CPM05L
Referencia	D-CPM03	D-CPM05	D-CPM05L
Medida exterior (Al x An x F)	160x420x200 mm	200x420x200 mm	210x560x200 mm
Compartimentos	3	5	5
Código EAN13	* 350000	* 350017	* 350024
Medida Packaging (Al x An x F)	160x420x200 mm	200x420x200 mm	210x560x200 mm
PRECIO	21,01 €	26,29 €	37,62 €

SOPORTE MURAL PLEGABLE 2 BICIS

FICHA TÉCNICA

Soporte de acero con extremos recubiertos de PVC antideslizante y anti-rayaduras.

Código EAN13

8425181 *



A-1068006 Soporte mural plegable 2 bicis

Ref.	kg.	↔	↕	↗	∅	Unids. /caja	EAN	∅I	∅L	PRECIO
A-1068006	35	500	310	510	25	3	* 728628	∅8 x 4	∅5 / L60 x 2	18,45 €

SOPORTE MURAL PLEGABLE BICI

FICHA TÉCNICA

Soporte de acero con extremos recubiertos de PVC antideslizante y anti-rayaduras.

Código EAN13

8412446 *



A-1068178



Ref.	kg.	↔	↗	∅	Unids. /caja	EAN	∅I	∅L	PRECIO
A-1068178	20	795	368	10	6	* 681781	∅8 x 4	∅5 / L60 x 2	10,15 €

Las medidas de taco y tornillo se indican a nivel informativo. Los productos NO INCLUYEN elementos de fijación.

GANCHO CUELGA BICIS

FICHA TÉCNICA

Soporte de acero

Código EAN13

8425181 *



A-1068106

Ref.	kg.	↔	↕	↙	∅	Unids. /caja	EAN	∅	L	PRECIO
A-1068106	25	100	200	178	16	6	* 728680	∅6 x 2	∅4 / L45 x 2	2,36 €

SOPORTE MULTIFUNCIONAL

FICHA TÉCNICA

Soporte de acero pintado en color gris.

Código EAN13

8425181 *



A-1068016

Ref.	kg.	↔	↕	↙	∅	Unids. /caja	EAN	∅	L	PRECIO
A-1068016	30	235	285	200	16	6	* 728635	∅6 x 4	∅4 / L50 x 4	5,02 €

Las medidas de taco y tornillo se indican a nivel informativo. Los productos NO INCLUYEN elementos de fijación.

GANCHO CON SOPORTE BALDA

FICHA TÉCNICA

Soporte de acero pintado en color gris.

Código EAN13

8425181 *



A-1068096

Ref.	kg.					Unids. /caja	EAN	Ø	L	PRECIO
A-1068096	30	235	160	18	6	728673 *	ø8 x 4	ø5 / L50 x 2	4,51 €	

GANCHO UNIVERSAL DOBLE

FICHA TÉCNICA

Soporte de acero.

Código EAN13

8425181 *

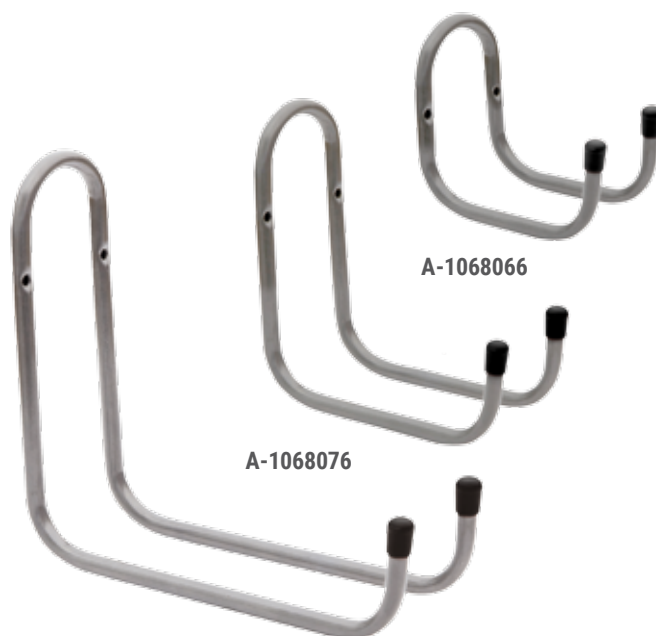

A-1068086

A-1068066

A-1068076

Ref.	kg.					Unids. /caja	EAN	Ø	L	PRECIO
A-1068086	10	70	205	315	10	6	728666 *	ø6 x 2	ø4 / L45 x 2	4,66 €
A-1068076	15	70	165	200	10	6	728659 *	ø8 x 2	ø4 / L45 x 2	3,28 €
A-1068066	20	70	100	160	10	6	728642 *	ø8 x 2	ø4 / L45 x 2	2,46 €

Las medidas de taco y tornillo se indican a nivel informativo. Los productos NO INCLUYEN elementos de fijación.

GANCHO DOBLE

FICHA TÉCNICA

Soporte de acero con extremos recubiertos de PVC antideslizante y anti-rayaduras.

Código EAN13 **8412446 ***



A-1068026

Ref.	kg.	↔	↕	↙	∅	Unids. /caja	EAN	∅	∅	PRECIO
A-1068026	35	65,5	120	88	12,5	6	* 680265	∅6 x 2	∅4 / L45 x 2	2,77 €

GANCHOS UNIVERSALES

FICHA TÉCNICA

Soporte de acero con extremos recubiertos de PVC antideslizante y anti-rayaduras.

Código EAN13 **8412446 ***



A-1068046

A-1068036

A-1068056

Ref.	kg.	↕	↙	∅	Unids. /caja	EAN	∅	∅	PRECIO
A-1068036	35	110	75	12	6	* 680364	∅6 x 2	∅4 / L45 x 2	1,90 €
A-1068046	35	210	150	16	6	* 680463	∅8 x 2	∅5 / L50 x 2	2,87 €
A-1068056	11	200	285	16	6	* 680562	∅8 x 2	∅5 / L50 x 2	3,59 €

Las medidas de taco y tornillo se indican a nivel informativo. Los productos NO INCLUYEN elementos de fijación.

GEO



FICHA TÉCNICA

Material:	Cuerpo de acero color antracita y tapa de acero inoxidable.
Dispone de cubeta interior extraíble en acero galvanizado.	
Fijación:	Dispone de 2 agujeros en la parte trasera con opción de amarrarlo a un lugar fijo mediante un cable o cadena.
Código EAN13	8425181 *



GEO
E-2441

Referencia	E-2441
Medida exterior (Al x An x F)	755x200x200 mm
Código EAN13	* 124413
PRECIO	79,44 €



Cajón extraíble para recogida de cenizas.



Con cadena para fijación.



Cenicero para suelo de gran estabilidad.

TARIFA

Las tarifas y condiciones de este catálogo anulan y sustituyen las emitidas anteriormente. Los precios indicados en el catálogo están en euros y no incluyen IVA. Precios válidos salvo error tipográfico.

UNIDADES DE EMBALAJE

Los pedidos deben respetar el número de unidades por caja señaladas en cada producto.

PEDIDO MÍNIMO Y PORTES

PENÍNSULA:

- Pedidos superiores a 200€ netos, portes pagados.
- Pedidos inferiores a 200€ netos, se cargarán 12€ netos en factura en concepto de portes.

ANDORRA Y BALEARES:

- Pedidos superiores a 350€ netos, portes pagados.
- Pedidos inferiores a 350€ netos, se cargarán 30€ en factura en concepto de portes.

CANARIAS:

- Pedido mínimo 200€ netos.
- Pedidos entre 200 y 850€ netos, FOB Bilbao.
- Pedidos superiores a 850€ netos, CFR Las Palmas o CFR Tenerife.

PORTUGAL (PENÍNSULA):

- Pedidos superiores a 600€ netos, portes pagados.

PARA OTROS DESTINOS, CONSULTAR CONDICIONES

PAGOS

Si se produjera un retraso en el pago sobre la fecha de vencimiento establecida, ARREGUI aplicará un recargo financiero de 0,50% mensual más 4 € en concepto de gastos de gestión.

En el caso de que se genere una devolución bancaria, el cliente deberá hacerse cargo de los gastos financieros que conlleve dicha devolución, además de 4€ en concepto de gastos de gestión.

La empresa no ofrece descuento por pronto pago. Si fuera requerido por parte del cliente, se estudiará de manera individualizada.

DEVOLUCIONES

Toda devolución de mercancía requiere de un número de devolución asignado previamente por ARREGUI tras la aprobación de la devolución. El número asignado ha de marcarse de forma visible en la mercancía devuelta.

No se admitirán devoluciones de productos descatalogados ni productos de color o medidas especiales.

Devoluciones por causas imputables al cliente:

Es condición indispensable devolver la mercancía en su embalaje original y sólo se abonarán las devoluciones de producto que estén en perfecto estado.

Toda devolución de mercancía por causa del cliente llevará un cargo del 5% del valor de factura (por cargos de gestión, revisión de mercancía, etc.), lo que implica que como máximo se abonará el 95% del valor de la mercancía.

La gestión y coste de transporte que se deriva de la retirada de la mercancía hasta su puesta en fábrica (ARREGUI) será a cargo del cliente.

Devoluciones por causas imputables a ARREGUI:

ARREGUI se hará cargo de la retirada y reposición o abono de la mercancía.

RECLAMACIONES

Para gestionar cualquier reclamación es imprescindible el envío de una fotografía que muestre el daño u objeto de la reclamación.

Las reclamaciones por golpes de transporte habrán de notificarse en un plazo máximo de 24 horas. Toda reclamación por golpe de transporte realizada por escrito a la agencia y/o a ARREGUI dentro de las 24 horas desde su recepción supondrá la sustitución o abono del 100% del importe. ARREGUI no se hará cargo de las reclamaciones realizadas fuera de este plazo.

Cualquier otro tipo de reclamación se atenderá de acuerdo a la Ley de Garantías en vigor.

Toda la información mostrada en este catálogo es ilustrativa y no tiene carácter contractual. ARREGUI se reserva el derecho de realizar las modificaciones necesarias para mejorar sus productos.

ARREGUI ESPAÑA:

Polígono Ind. Ubegun 3B
20810 Orío (Guipúzcoa)
+34 943 833 700
+34 943 834 556
arregui@arregui.es



ARREGUI DOMUS:

Via Costituente 6
42041 Brescello (RE)
+05 221 520 048
+05 221 520 050
arregui@arregui.it

ARREGUI TAIWAN:

Nan Fu Str 159-3
Luzhu Taoyuan