



GEDY

CATALOGO - CATALOGUE

2015



Gedy S.p.A
Via dell'Industria, 6
21040 Origgio (VA) - Italia
Tel. +39.02.96.95.01
Fax +39.02.96.73.43.01
www.gedy.com - info@gedy.com

2015

CATALOGO - CATALOGUE - KATALOG
CATÁLOGO - КАТАЛОГ

GEDY realizza oggetti belli da vivere tutti i giorni.
Disegnati e progettati da famosi designer di tutto il mondo,
i prodotti GEDY si distinguono per funzionalità, praticità, stile.

Gedy makes beautiful items to use every day.
Conceived and designed by famous designers from all over
the world, the uniqueness of Gedy products for functionality,
practicality and style is always very clear.



coordinati colore

INDICE - INDEX

□ WALL - PAG. 76



G•2900 PAG. 76



G•FELCE PAG. 58



G•KENT PAG. 8



G•PIRENE PAG. 24



G•ARIZONA PAG. 46



G•FICUS PAG. 62



G•LOUNGE PAG. 12



G•ROMANCE PAG. 34



G•ASCOT PAG. 48



G•GENZIANA PAG. 64



G•MAINE PAG. 30



G•TEXAS PAG. 38



G•BERNINA PAG. 22



G•GLAMOUR PAG. 16



G•MINDY PAG. 84



G•VERMONT PAG. 40



G•COLORADO PAG. 42



G•HOT PAG. 66



G•MINNESOTA PAG. 20



G•WENDY PAG. 74



G•DARIOS PAG. 72

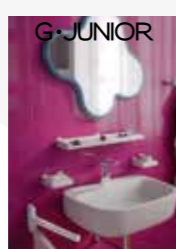

G•JUNIOR PAG. 80



G•MONTANA PAG. 68



G•EDERA PAG. 54



G•KANSAS PAG. 26



G•NEW JERSEY PAG. 52

■ BEAUTY - PAG. 87

■ TABLE TOP - PAG. 105

G•ALTEA	106	G•IDRA	129	G•ORTENSIA	133
G•ANTARES	125	G•JAMILA	114	G•PETUNIA	119
G•ACQUARIUS	131	G•LIBRA	127	G•POLARIS	109
G•ARIES	128	G•LUNA	136	G•PRIMULA	111
G•AURIGA	130	G•MAGNOLIA	126	G•QUADROTTO	135
G•ZALEA	118	G•MARTINA	115	G•RAINBOW	122
G•BAMBU'	107	G•MELISSA	126	G•SEVENTY	140
G•DALIA	118	G•MIZAR	117	G•SOLE	134
G•ERICA	107	G•MOBY	138	G•STONE	113
G•ETNICA	135	G•MUGHETTO	116	G•TWIST	120
G•FLOU	137	G•MYOSOTIS	114	G•VEGA	124
G•FORSIZIA	112	G•NAOS	110	G•VERBENA	119
G•GEMINI	132	G•NEMESIA	108		
G•GLADY	139	G•NIGELLA	111		

■ HYGIENE - PAG. 141

■ MULTIFUNCTION - PAG. 171

■ SENSORIAL - PAG. 299

■ HOTELLERIE - PAG. 315

La sequenza delle misure indicate per ogni articolo è la seguente: larghezza - profondità - altezza
 The succession of the sizes for each article is the following: width - thickness - height
 La séquence des mesures indiquées pour chaque article est la suivante: largeur - profondeur - hauteur
 Die Reihenfolge der Maße, die für jeden Artikel angezeigt werden, ist das folgende: Breite - Tiefe - Höhe
 La secuencia de las medidas indicadas para cada artículo es la siguiente: anchura - profundidad - altura
 Последовательность измерений показанных для каждой статьи: ширина - глубина - высота



WALL

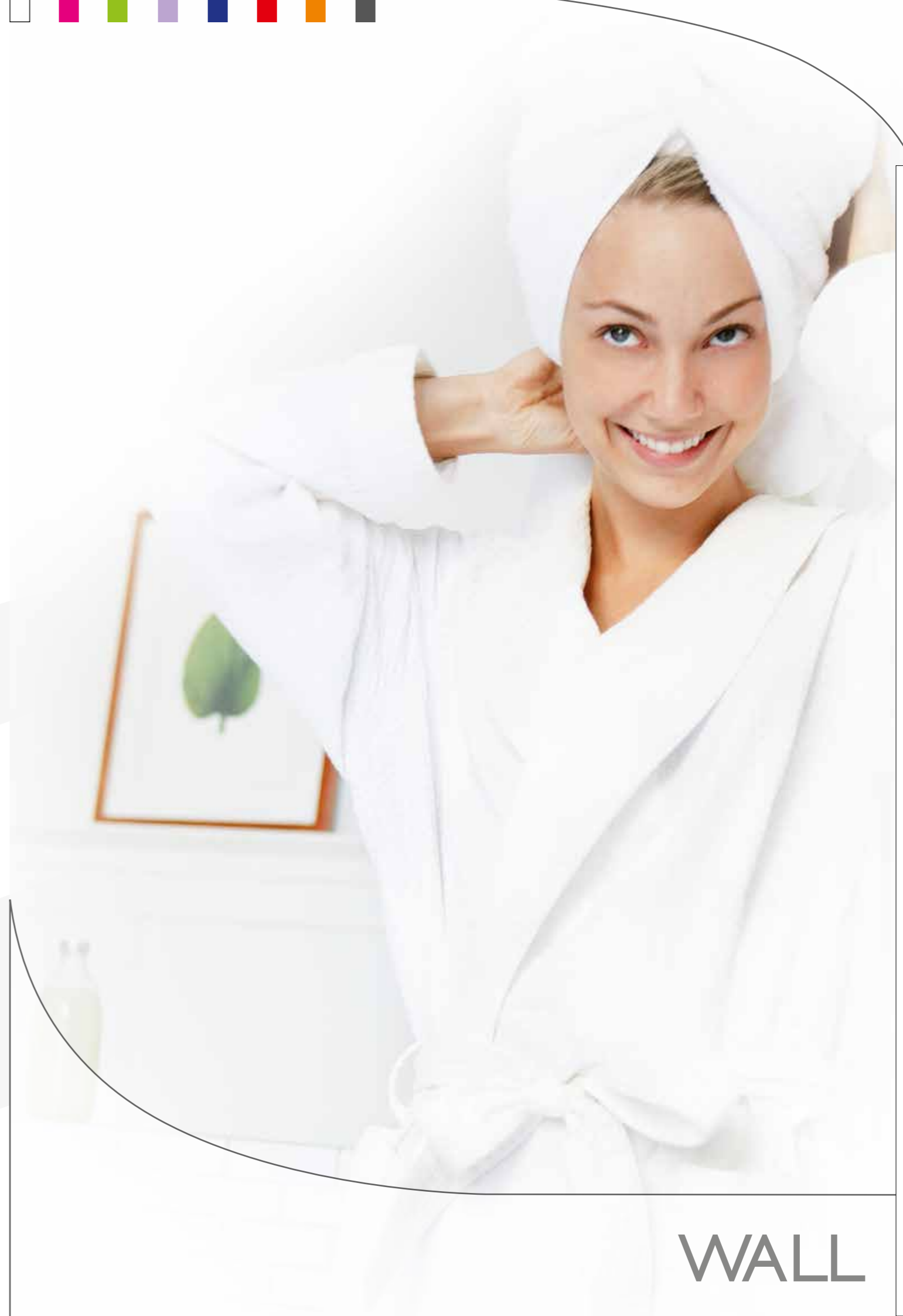

WALL

G•KENT

Realizzata in ottone e Cromall® con contenitori in vetro satinato
Made of brass and Cromall® with satinized glass containers
Réalisée en laiton et Cromall® avec boîtiers en verre satiné
Hergestellt aus Messing und Cromall® mit Behältern aus satiniertem Glas
Realizada en latón y Cromall® con contenedores en cristal satinado
Изготовлено из латуни и Cromall® с ёмкостями из матового стекла

13

Cromato
Chromed



5510

7,9 x 8,6 x 10,3 cm



5511

11,5 x 9,5 x 2,2 cm



5581

7,9 x 8,6 x 16 cm



5570

23,2 x 5,4 x 14,6 cm



5533

9,7 x 9 x 36,2 cm



5523

36,5 x 1,5 x 7 cm



5527

2,8 x 5 x 3 cm

5521/30

30,2 x 5,8 x 2,8 cm



5521/45

45 x 5,8 x 2,8 cm



5521/60

60,3 x 5,8 x 2,8 cm



5524

15 x 7 x 2,8 cm



5525

15 x 10,7 x 7,7 cm



G• LOUNGE

Realizzata in ottone, alluminio e Cromall® con contenitori in vetro satinato
Made of brass, aluminium and Cromall® with satinized glass containers
Réalisée en laiton, aluminium et Cromall® avec boîtiers en verre satiné
Hergestellt aus Messing, Aluminium und Cromall® mit Behältern aus satiniertem Glas
Realizada en latón, aluminio y Cromall® con contenedores en cristal satinado
Изготовлено из латуни, алюминия и Cromall® с ёмкостями из матового стекла

13

Cromato
Chromed



5410

7 x 9,5 x 9,9 cm



5411

12 x 12 x 4,1 cm



5481

6,8 x 11,6 x 15,6 cm



5433/O3

8 x 11,2 x 40,4 cm



5433

8 x 8 x 40,4 cm



5412

14 x 11 x 2,5 cm



5418

24,6 x 13,7 x 2,5 cm



5426

7 x 3 x 3 cm



5423

4,6 x 37,5 x 2,6 cm



5470

20,3 x 9,8 x 2,4 cm

5421/45

44,2 x 5,4 x 2,4 cm



5421/60

59,2 x 5,4 x 2,4 cm



5424

13 x 9,6 x 2,2 cm



5425

13,1 x 13,9 x 4,6 cm

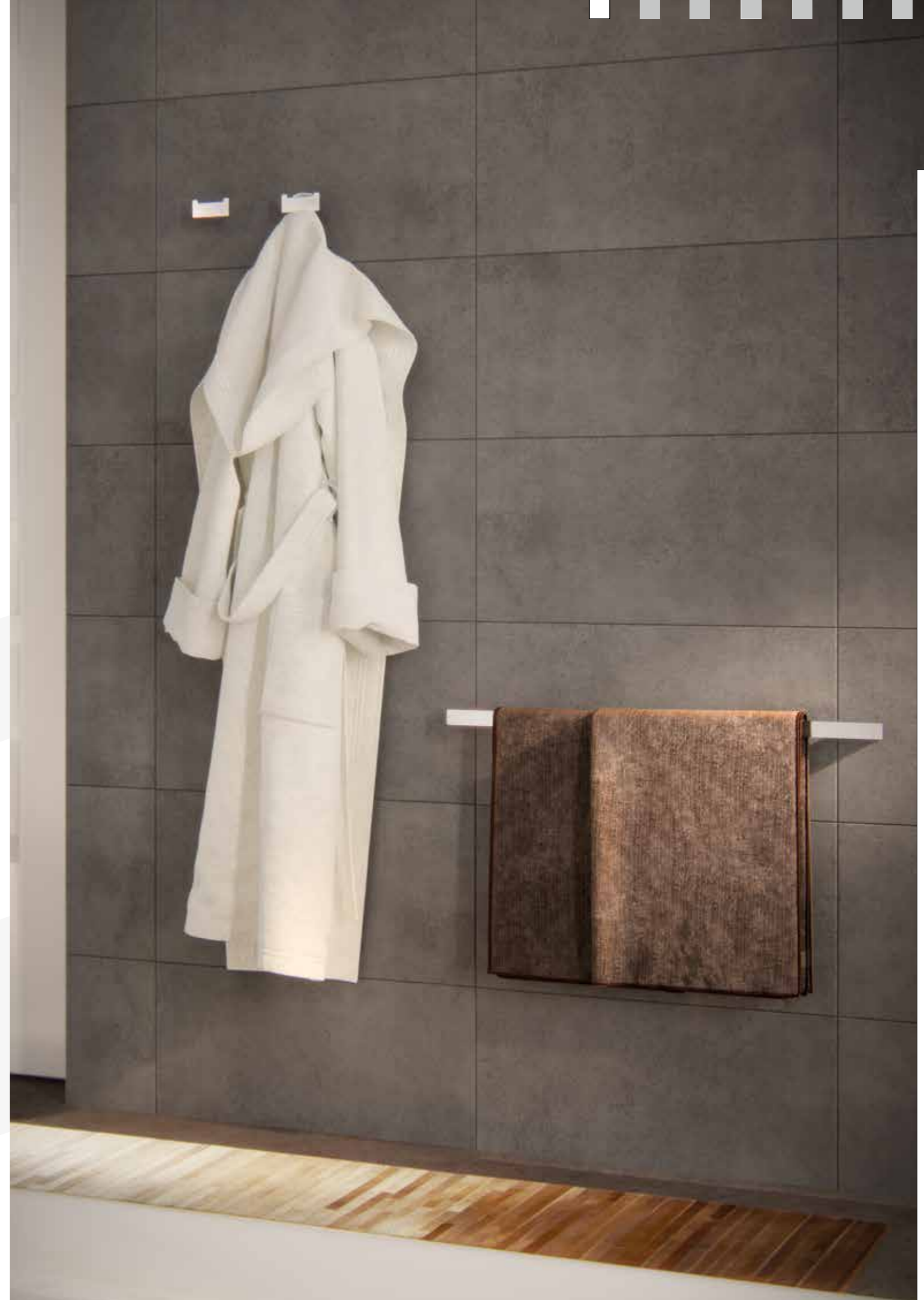

G • GLAMOUR

Design: Piet Billekens

Realizzata in ottone e Cromall® con contenitori in vetro satinato
Made of brass and Cromall® with satinized glass containers
Réalisée en laiton et Cromall® avec boîtiers en verre satiné
Hergestellt aus Messing und Cromall® mit Behältern aus satiniertem Glas
Realizada en latón y Cromall® con contenedores en cristal satinado
Изготовлено из латуни и Cromall® с ёмкостями из матового стекла

13

Cromato
Chromed



5710

8 x 11 x 11 cm



5711

15 x 13 x 3 cm



5781

8 x 11 x 6 cm



5733/03

10 x 13 x 39 cm



5733

10 x 10 x 39 cm

02

Bianco
White



5728
3,2 x 7,7 x 4 cm



5726
4,2 x 3,7 x 2,6 cm



5724
15,7 x 8,2 x 2 cm

5721/30
30 x 8,2 x 2 cm



5721/45
45 x 8,2 x 2 cm



5721/60
60 x 8,2 x 2 cm



5719/60
60 x 11,8 x 2,3 cm



Vetro temperato - tempered glass
Verre tempéré - Sekuritglas
Cristal templado - Закаленный стекло



5770
24 x 8,2 x 12,4 cm



5723
3,2 x 33,5 x 4 cm



G•MINNESOTA

Design: R. & S. Prodotto Gedy

Realizzata in Cromall® e acciaio inox con contenitori in ceramica
 Made of Cromall® and stainless steel with pottery containers
 Réalisée en Cromall® et acier inoxydable avec boîtiers en céramique
 Hergestellt aus Cromall® und Edelstahl mit Behältern aus Keramik
 Realizada en Cromall® y acero inox con contenedores en cerámica
 Изготовлено из Cromall® и нержавеющей стали с ёмкостями из керамики

13

Cromato
Chromed



6610
13 x 10 x 11,5 cm



6611
18,5 x 10,5 x 3 cm



6626
6,5 x 5,5 x 3 cm

6621/30
30,4 x 5,5 x 3 cm



6621/45
45,2 x 5,5 x 3 cm



6621/60
60 x 5,5 x 3 cm



6670
20 x 8 x 11,5 cm



6623
32,5 x 5,2 x 6,5 cm

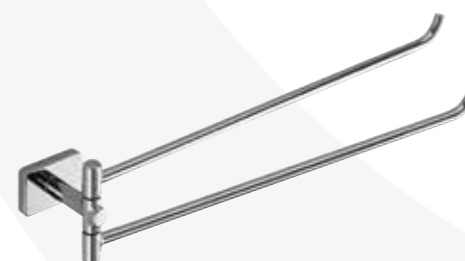

6624
15 x 7,6 x 8,5 cm



6625
15 x 8 x 13 cm



6633/03
15,5 x 12,5 x 37,5 cm



6633
10,2 x 10,2 x 37,5 cm

02

Bianco
White



pag. 187

G•TEXAS

Realizzata in ottone e Cromall® con contenitori in vetro satinato
 Made of brass and Cromall® with satinized glass containers
 Réalisée en laiton et Cromall® avec boîtiers en verre satiné
 Hergestellt aus Messing und Cromall® mit Behältern aus satinierem Glas
 Realizada en latón y Cromall® con contenedores en cristal satinado
 Изготовлено из латуни и Cromall® с ёмкостями из матового стекла

13

Cromall®
 Chromall®



3710
6,5 x 9,8 x 11 cm



3711
14,6 x 10,7 x 5 cm



3781
8 x 9,5 x 20 cm



3726
4,7 x 5,5 x 5,7 cm

3721 / 35
35 x 10 x 4 cm



3721 / 45
45 x 10 x 4 cm



3721 / 60
60 x 10 x 4 cm



3770
19,8 x 7,8 x 13,5 cm



3723
36,5 x 5,8 x 5,6 cm



3724
16,5 x 8 x 4 cm



3733
11,5 x 9,5 x 41 cm



Acciaio inox - Stainless steel - Acier inoxydable
 Edelstahl - Acero inox - Нержавеющая сталь

G·PIRENEI

Serie in ottone e Cromall® con contenitori in vetro satinato
 Line made of brass and Cromall® with satinized glass containers
 Série en laiton et Cromall® avec boîtiers en verre satiné
 Serie aus Messing und Cromall® mit Behältern aus satiniertem Glas
 Serie en latón y Cromall® con contenedores en cristal satinado
 Изготовлено из латуни и Cromall® с ёмкостями из матового стекла

13

Cromato
Chromed



PI10

6,9 x 9,1 x 10,4 cm



PI11

11 x 11,2 x 4 cm



PI81

6,9 x 9,1 x 15,4 cm



PI27

2 x 3,3 x 5,3 cm

PI21/35

35 x 6,6 x 2,5 cm



PI21/45

45 x 6,6 x 2,5 cm



PI21/60

60 x 6,6 x 2,5 cm



PI70

23 x 5 x 15 cm



PI23

35 x 6,6 x 2,5 cm



PI24

17,5 x 6,6 x 2,5 cm



PI33-03

8,5 x 10,9 x 36,5 cm

G•KANSAS

Design: R. & S. Prodotto Gedy

Realizzata in alluminio e Cromall® con contenitori in vetro satinato o acciaio inox
 Made of aluminum and Cromall® with satinized glass containers or stainless steel
 Réalisée en aluminium et Cromall® avec boîtiers en verre satiné ou acier inoxydable
 Hergestellt aus Aluminium und Cromall® mit Behältern aus satiniertem Glas oder Edelstahl
 Realizada en aluminio y Cromall® con contenedores en cristal satinado o acero inox
 Изготовлено из алюминия и Cromall® с ёмкостями из матового стекла или нержавеющей стали

13

Cromato
Chromed



3810
6,8 x 11,7 x 9,6 cm



3811
10,5 x 13,2 x 4 cm



3881
6,8 x 11,7 x 17 cm



38101310
6,8 x 12,4 x 6,9 cm



38111310
13,8 x 10,6 x 3 cm



38811310
6,9 x 6,9 x 17,3 cm

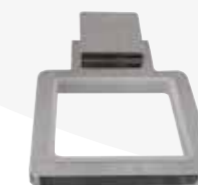

38101300
7 x 11,3 x 1,8 cm



3833
8,7 x 8,7 x 36 cm
Acciaio cromato - Chromed steel - Acier chromé
Verchromter Stahl - Acero cromado - Хромированная сталь



3826

8,2 x 5,5 x 1,8 cm



3824

14 x 6,2 x 9,7 cm

3821/35

35 x 6,2 x 1,6 cm



3821/45

45 x 6,2 x 1,6 cm



3821/60

60 x 6,2 x 1,6 cm



3819/60

60 x 11,7 x 1,6 cm



Vetro temperato - tempered glass
Verre tempéré - Sekuritglas
Cristal templado - Закаленный стекло

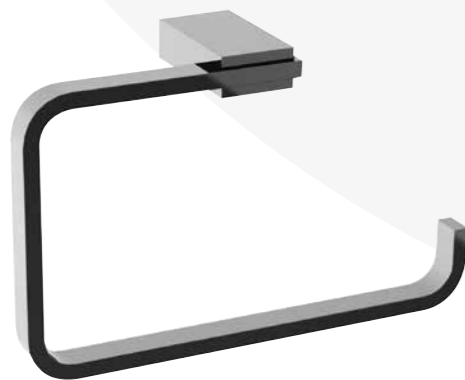

3870

20 x 6,2 x 12,7 cm



3823

30,4 x 6,2 x 3,8 cm



G•MAINE

Design: R. & S. Prodotto Gedy

Realizzata in acciaio inox e Cromall® con contenitori in vetro satinato
 Made of stainless steel and Cromall® with satinized glass containers
 Réalisée en acier inoxydable et Cromall® avec boîtiers en verre satiné
 Hergestellt aus Edelstahl und Cromall® mit Behältern aus satiniertem Glas
 Realizada en acero inox y Cromall® con contenedores en cristal satinado
 Изготовлено из нержавеющей стали и Cromall® с ёмкостями из матового стекла

13

Cromato
Chromed



7810

6,8 x 9,7 x 12,4 cm



7811

14,6 x 10,6 x 6 cm



7881

6,9 x 11 x 16,8 cm

FISSAGGIO CON VITI • FIXES WITH SCREWS
 FISSAGGIO AD INCOLLO • FIXES INTO PLACE WITH GLUE
 TEST CONDOTTI DALL'ISTITUTO DI CERTIFICAZIONE QUALITÀ CABIATE (CO)
 TESTED BY ISTITUTO DI CERTIFICAZIONE QUALITÀ CABIATE (CO)
 10 KG

Fissaggio ad incollaggio o con viti
 Fixes into place with screws or glue
 Fixation par encollage ou par vis
 Befestigung mit Klebstoff oder Schrauben
 Fijación por medio de pegado o con tornillos
 Крепление при помощи шурупов или клея



7870

22,3 x 6,6 x 16,3 cm



7833

ø 8,4 x 36 cm

Acciaio - Steel - Acier - Stahl - Acero - Сталь

Design: Piet Billekens

GIRLA LA PLACCA COME VUOI E COPRI I VECCHI FORI
 THE AS REQUIRED TO COVER THE OLD HOLES

pag. 91
 pag. 172
 pag. 188



7826
7,5 x 6,6 x 6 cm



7823
36 x 5,6 x 6 cm
Fissaggio con viti - Screw fixing

7821/35
38 x 6,5 x 6 cm



7821/45
47,5 x 6,5 x 6 cm



7821/60
62,6 x 6,5 x 6 cm



Colori placca acquistabili a parte

Colors plates available as spare parts

- | | | | |
|---------------------------------------------------------------------------------------|-------------------------------------|---------------------------------------------------------------------------------------|--------------------------|
|  | 04
verde/
green |  | 67
arancio/
orange |
|  | 06
rosso/
red |  | 76
fucsia/
fuchsia |
|  | 13
cromato
lucido/
chromed |  | 79
lilla/
lliac |
|  | 14
nero/
black | | |



7824
15 x 6,6 x 6 cm



7825
14,3 x 6,8 x 15 cm



7805
4 x 0,7 x 6,5 cm



G•ROMANCE

Design: R. & S. Prodotto Gedy

Realizzata in acciaio inox e Cromall® con contenitori in vetro satinato
 Made of stainless steel and Cromall® with satinized glass containers
 Réalisée en acier inoxydable et Cromall® avec boîtiers en verre satiné
 Hergestellt aus Edelstahl und Cromall® mit Behältern aus satiniertem Glas
 Realizada en acero inox y Cromall® con contenedores en cristal satinado
 Сделано из нержавеющей стали и Cromall® с ёмкостями из матового стекла

44

Bronzo
Bronzed



7510

7,4 x 11,4 x 11,5 cm



7511

14,6 x 11,6 x 5,6 cm



7581

7,2 x 12,3 x 17,4 cm



Fixabile anche con colla (venduta a parte)
 Can be fixed with glue (sold separately)
 Peut être fixé avec colle (vendu séparément)
 Kann mit Kleber fixiert werden (separat erhältlich)
 Se puede fijar con pegamento (se vende por separado)
 Может быть закреплён клеем (продается отдельно)



7533/O3

10,9 x 14,5 x 41,8 cm



7533

ø 9 x 41 cm



pag. 186



pag. 142



7526
8,2 x 7,7 x 5,6 cm

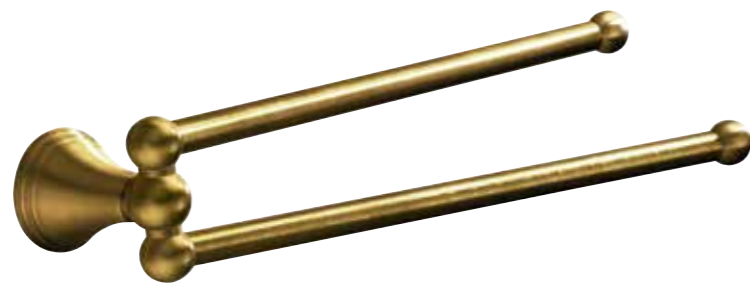

7523
36,3 x 7,7 x 7,4 cm
fissaggio con viti - fixed with screws

7521 / 35

34,8 x 7,7 x 5,6 cm



7521 / 45

44,8 x 7,7 x 5,6 cm



7521 / 60

59,8 x 7,7 x 5,6 cm



7519 / 60

60 x 11 x 5,6 cm



Vetro temperato - tempered glass
Verre tempéré - Sekuritglas
Cristal templado - Закаленный стекло

fissaggio con viti - fixed with screws



7570
18 x 7,7 x 20,2 cm



7524
17,8 x 7,7 x 5,6 cm



7525
16,4 x 7,7 x 13,7 cm



G·BERNINA

Serie in Cromall® e acciaio inox con contenitori in vetro satinato
 Line made of Cromall® and stainless steel with satinized glass containers
 Série en Cromall® et acier inoxydable avec boîtiers en verre satiné
 Serie aus Cromall® und Edelstahl mit Behältern aus satiniertem Glas
 Serie en Cromall® y acero inoxidable con contenedores en cristal satinado
 Изготовлено из Cromall® и нержавеющей стали с ёмкостями из матового стекла

13

Cromato
Chromed



BE10

8 x 10 x 10,4 cm



BE1

11 x 12 x 3,9 cm



BE81

8 x 10 x 15,4 cm



BE26

8,5 x 5,5 x 4 cm

BE21/35

35 x 6,5 x 3,5 cm



BE21/45

45 x 6,5 x 3,5 cm



BE21/60

60 x 6,5 x 3,5 cm



BE70

23 x 6,6 x 15 cm



BE24

18 x 6,5 x 3,5 cm



BE25

16,2 x 7 x 11,2 cm

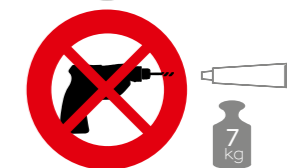

Fissabile anche con colla (venduta a parte)
 Can be fixed with glue (sold separately)
 Peut être fixé avec colle (vendu séparément)
 Kann mit Kleber fixiert werden (separat erhältlich)
 Se puede fijar con pegamento (se vende por separado)
 Может быть закреплен клеем (продается отдельно)

G·VERMONT

Realizzata in acciaio inox e Cromall® con contenitori in vetro satinato
 Made of stainless steel and Cromall® with satinized glass containers
 Réalisée en acier inoxydable et Cromall® avec boîtiers en verre satiné
 Hergestellt aus Edelstahl und Cromall® mit Behältern aus satiniertem Glas
 Realizada en acero inox y Cromall® con contenedores en cristal satinado
 Изготовлено из нержавеющей стали и Cromall® с ёмкостями из матового стекла

13
 Cromato
 Chromed

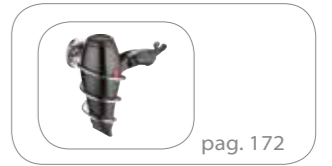

4210
 6,5 x 11 x 9,5 cm



4211
 11 x 13 x 6 cm



4226
 7,5 x 5 x 6 cm

4221 / 35
 35,4 x 8,2 x 6 cm



4221 / 45
 45,5 x 8 x 6 cm



4221 / 60
 60,5 x 9,1 x 6 cm

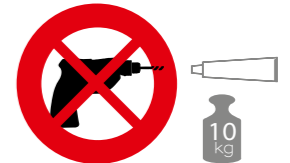

Fissabile anche con colla (venduta a parte)
 Can be fixed with glue (sold separately)
 Peut être fixé avec colle (vendu séparément)
 Kann mit Kleber fixiert werden (separat erhältlich)
 Se puede fijar con pegamento (se vende por separado)
 Может быть закреплен клеем (продается отдельно)

4270
 22,5 x 6 x 16 cm



4223
 35 x 7 x 6 cm



fissaggio con viti - fixed with screws



4224
 18,3 x 8,4 x 6 cm



4225
 17 x 6 x 14,5 cm



4233
 ø 9,1 x 37,3 cm
 Acciaio - Steel - Acier - Stahl - Acero - Сталь

G·COLORADO

Realizzata in ottone e Cromall® con contenitori in vetro satinato o acciaio inox
 Made of brass and Cromall® with satinized glass containers or stainless steel
 Réalisée en laiton et Cromall® avec boîtiers en verre satiné ou acier inoxydable
 Hergestellt aus Messing und Cromall® mit Behältern aus satiniertem Glas oder Edelstahl
 Realizada en latón y Cromall® con contenedores en cristal satinado o acero inox
 Изготовлено из латуни и Cromall® с ёмкостями из матового стекла или нержавеющей стали

13

Cromato
Chromed

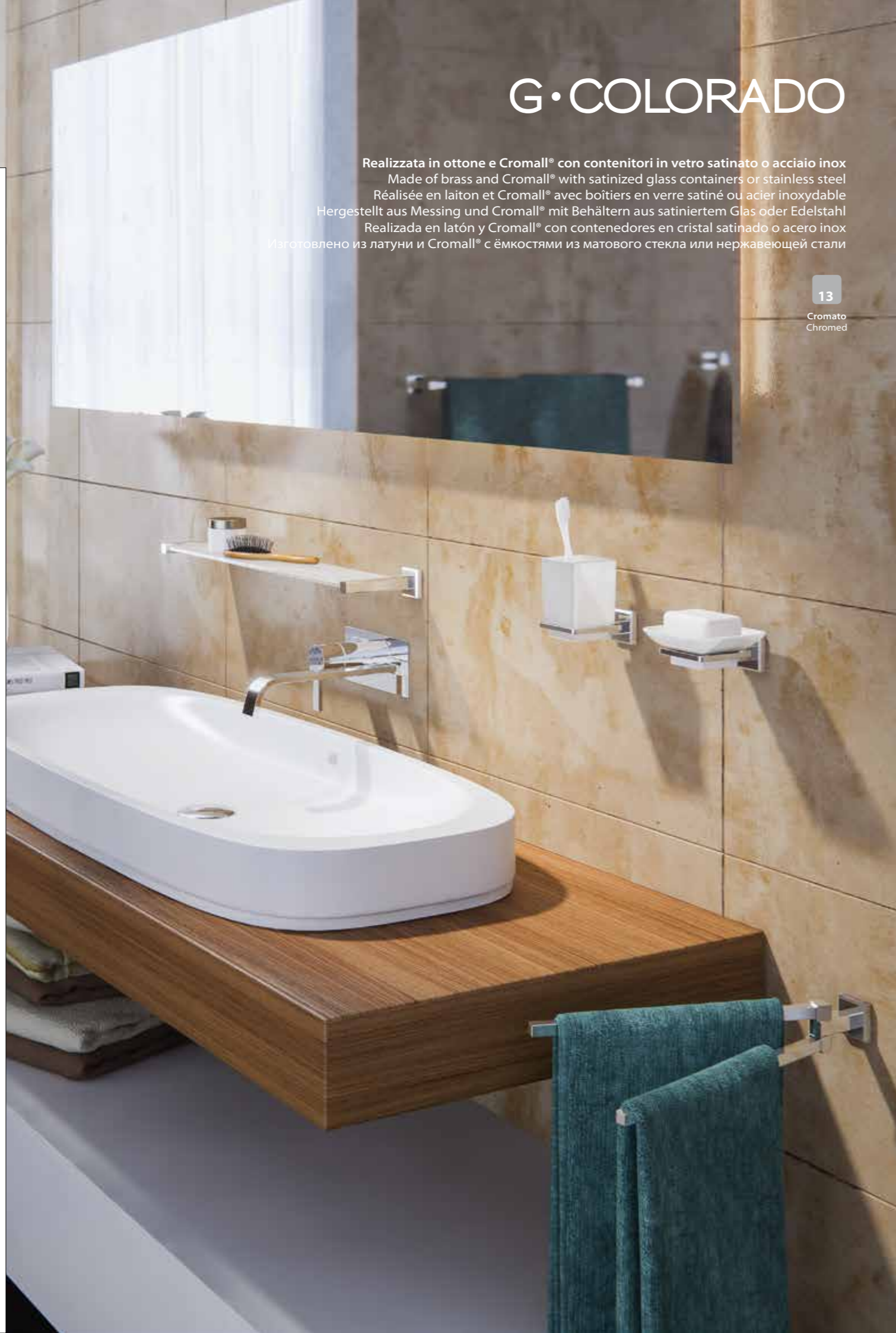

6910

7 x 10,5 x 10,5 cm



6911

10 x 12,5 x 5 cm



6981

7 x 10,5 x 15,5 cm



38101310

6,8 x 12,4 x 6,9 cm



38111310

13,8 x 10,6 x 3 cm



69101300

7 x 11,3 x 1,8 cm



38811310

6,9 x 6,9 x 17,3 cm



6933

8,7 x 8,7 x 36 cm

Acciaio inox - Stainless steel
 Acier inoxydable - Edelstahl
 Асоро inox - Нержавеющая сталь



Fissabile anche con colla (venduta a parte)
 Can be fixed with glue (sold separately)
 Peut être fixé avec colle (vendu séparément)
 Kann mit Kleber fixiert werden (separat erhältlich)
 Se puede fijar con pegamento (se vende por separado)
 Может быть закреплён клеем (продается отдельно)



6923

4 x 36 x 5,5 cm

fissaggio con viti - fixed with screws



6926

4 x 5 x 4 cm



6928

6,5 x 6 x 4 cm

6921/35

35 x 8 x 4 cm



6921/45

45 x 8 x 4 cm



6921/60

60 x 8 x 4 cm



6919/60

57 x 11,5 x 4 cm

Vetro temperato - tempered glass
Verre tempéré - Sekuritglas
Cristal templado - Закаленный стекло

fissaggio con viti - fixed with screws



6970

20 x 6,5 x 14,5 cm

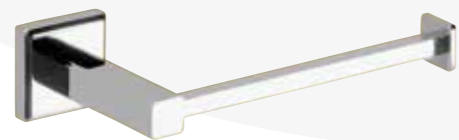

6924

17 x 8 x 4 cm



6925

14,3 x 6,5 x 12 cm



G•ARIZONA

Design: R. & S. Prodotto Gedy

Realizzata in acciaio inox con copriplacche e contenitori in resine termoplastiche

Made of stainless steel with coverplates and containers of thermoplastic resins

Réalisée en acier inoxydable avec couvreplaques et boîtiers en thermoplastique

Hergestellt aus Edelstahl mit Rosetten und Behältern aus Kunststoff

Realizada en acero inox con embellecedores y contenedores en resinas termoplásticas

Изготовлено из нержавеющей стали с декоративными накладками и ёмкостями из термопластических смол

13

Cromato
Chromed



Solo su superfici lisce (specchi, piastrelle)
For flat surfaces (mirrors, tiles) only



Fissaggio con biadesivo
To be fixed with double - sided sticky tape

Fixation avec adhésif double face - Befestigung mit doppelseitigem
Kleband - Fijación con biadhesivo Крепление при помощи двухсторонней
адгезивной ленты

7
kg



6210

8,5 x 13 x 11,5 cm



6211

14 x 14 x 6,5 cm



6227

ø 6,5 x 8 cm

6221 / 35

35,5 x 8 x 6,5 cm



6221 / 45

45,5 x 8 x 6,5 cm



6221 / 60

60 x 8 x 6,5 cm



6270

20,5 x 6 x 22,5 cm



6224

19,5 x 8,9 x 6,5 cm



6233 / 03

9,5 x 13 x 41 cm

G·ASCOT

Design: Carlo Vietri

Realizzata in acciaio inox e Cromall® con contenitori in vetro satinato
Made of stainless steel and Cromall® with satinized glass containers
Réalisée en acier inoxydable et Cromall® avec boîtiers en verre satiné
Hergestellt aus Edelstahl und Cromall® mit Behältern aus satiniertem Glas
Realizada en acero inox y Cromall® con contenedores en cristal satinado
Изготовлено из нержавеющей стали и Cromall® с ёмкостями из матового стекла

13

Cromato
Chromed



2710/06
9 x 13,5 x 10,5 cm



2711/06
13,5 x 13,5 x 6,5 cm



2712
13,5 x 13,5 x 6,2 cm



2733/03
8,5 x 9 x 38 cm
Acciaio - Steel - Acier - Stahl - Acero - Сталь



2733
ø 8,5 x 38 cm
Acciaio - Steel - Acier - Stahl - Acero - Сталь

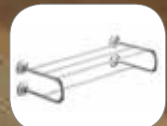

pag. 325



2723
42,8 x 6,5 x 7,4 cm



2727
6,2 x 7,5 x 6,5 cm



2770
20 x 5,5 x 22 cm



2721 / 35
35 x 8 x 6,2 cm



2721 / 45
45 x 8 x 6,2 cm



2721 / 60
60 x 8 x 6,2 cm



2724
20 x 8,5 x 6,2 cm



2724 / 02
6 x 11 x 20 cm



2724 / 03
6,2 x 10 x 38,5 cm



2725
12,3 x 12,5 x 8 cm
Acciaio inox - Stainless steel - Acier inoxydable
Edelstahl - Acero inox - Нержавеющая сталь



G • NEW JERSEY

Design: R. & S. Prodotto Gedy

Realizzata in Cromall®, acciaio inox, resine termoplastiche e vetro satinato
 Made of Cromall®, stainless steel, thermoplastic resins and satinized glass
 Réalisée en Cromall®, acier inoxydable, thermoplastique et verre satiné
 Hergestellt aus Cromall®, Edelstahl, Kunststoff und satiniertem Glas
 Realizada en Cromall®, acero inox, resinas termoplásticas y cristal satinado
 Изготовлено из Cromall®, нержавеющей стали, термопластичных смол и матового стекла

13

Cromato
Chromed



2810
6,7 x 9,8 x 9,6 cm



2811
10,9 x 11,9 x 5 cm



2881
6,8 x 11 x 15,5 cm



2826
7 x 6,7 x 4,2 cm

2821 / 35
37,6 x 6,7 x 4,2 cm



2821 / 45
47,6 x 6,7 x 4,2 cm



2821 / 60
62,6 x 6,7 x 4,2 cm



2870
20,5 x 6,7 x 12 cm



2824
17 x 6,7 x 4,2 cm



2825
14,5 x 7,2 x 11 cm



2833
9 x 9 x 38 cm
Acciaio inox - Stainless steel - Acier inoxydable
Edelstahl - Acero inox - Нержавеющая сталь



Fissaggio ad incollo o con viti
 Fixes into place with screws or glue
 Fixation par encollage ou par vis
 Befestigung mit Klebstoff oder Schrauben
 Fijación por medio de pegado o con tornillos
 Крепление при помощи шурупов или клея

G•EDERA

Realizzata in acciaio inox e Cromall® con contenitori in vetro satinato
 Made of stainless steel and Cromall® with satinized glass containers
 Réalisée en acier inoxydable et Cromall® avec boîtiers en verre satiné
 Hergestellt aus Edelstahl und Cromall® mit Behältern aus satiniertem Glas
 Realizada en acero inox y Cromall® con contenedores en cristal satinado
 Изготовлено из нержавеющей стали и Cromall® с ёмкостями из матового стекла

02

Bianco laccato
White lacquered

13

Cromato
Chromed



ED10

11,4 x 9,8 x 9,6 cm



ED11

13,5 x 11,5 x 4,9 cm



ED12

13,7 x 13,2 x 5 cm



ED81

11,4 x 9,8 x 15,2 cm



ED34/O3

7,5 x 8 x 40 cm

Acciaio inox - Stainless steel - Acier inoxydable
Edelstahl - Acero inox - Нержавеющая сталь



ED34

ø 7,5 x 40 cm

Acciaio inox - Stainless steel - Acier inoxydable
Edelstahl - Acero inox - Нержавеющая сталь



pag. 326



ED23
36 x 4,6 x 5,2 cm

ED26
7,7 x 7,4 x 4,9 cm

ED70
23 x 7,4 x 15,5 cm



ED21 / 35
37,6 x 7,4 x 4,9 cm



ED21 / 45
45,7 x 7,4 x 4,9 cm



ED21 / 60
62 x 7,4 x 4,9 cm



ED19 / 55
53,3 x 13 x 4,9 cm

Vetro temperato
tempered glass
Verre tempéré
Sekuritglas
Cristal templado
Закаленный стекло



ED24
15,9 x 7,4 x 4,9 cm



ED24 / O2
8,6 x 11 x 17 cm



ED25
15,2 x 7,4 x 13 cm



G • FELCE

Realizzata in acciaio e Cromall® con contenitori in vetro satinato
 Made of steel and Cromall® with satinized glass containers
 Réalisée en acier et Cromall® avec boîtiers en verre satiné
 Hergestellt aus Stahl und Cromall® mit Behältern aus satiniertem Glas
 Realizada en acero y Cromall® con contenedores en cristal satinado
 Изготовлено из стали и Cromall® с ёмкостями из матового стекла

13

Cromato
Chromed



FE10

6,7 x 10,2 x 10 cm



FE11

11 x 12,3 x 5,6 cm



FE81

6,8 x 10,3 x 15,4 cm



FE70

19,3 x 5,5 x 15,2 cm



FE33

ø 7,8 x 33,4 cm

Acciaio/resine termoplastiche - Steel/thermoplastic resins
 Acier/thermoplastique - Stahl/Kunststoff
 Acero/resinas termoplásticas - Сталь/термопластичные смолы

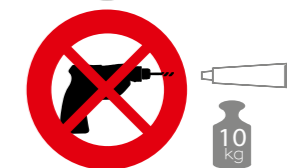

Fissabile anche con colla (venduta a parte)
 Can be fixed with glue (sold separately)
 Peut être fixé avec colle (vendu séparément)
 Kann mit Kleber fixiert werden (separat erhältlich)
 Se puede fijar con pegamento (se vende por separado)
 Может быть закреплён клеем (продается отдельно)

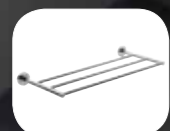

pag. 326



FE23

36,9 x 4,8 x 5,6 cm
Fissaggio con viti - To be fixed with screws



FE26

6,5 x 5,5 x 5,6 cm

FE21 / 35

39,6 x 7,4 x 5,6 cm



FE21 / 45

52 x 7,4 x 5,6 cm



FE21 / 60

64,6 x 7,4 x 5,6 cm



FE19 / 55

52 x 13,1 x 5,6 cm

Fissaggio con viti
To be fixed with screws

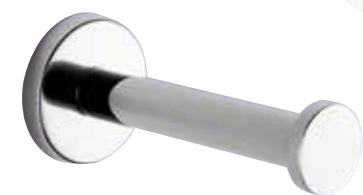

FE24

5,5 x 12,8 x 5,5 cm



FE29

15,5 x 7,8 x 5,6 cm



FE25

13,5 x 5,6 x 14,5 cm



G·FICUS

Realizzata in acciaio e Cromall® con contenitori in vetro satinato
 Made of steel and Cromall® with satinized glass containers
 Réalisée en acier et Cromall® avec boîtiers en verre satiné
 Hergestellt aus Stahl und Cromall® mit Behältern aus satiniertem Glas
 Realizada en acero y Cromall® con contenedores en cristal satinado
 Изготовлено из стали и Cromall® с ёмкостями из матового стекла

13

Cromato
Chromed



F110

6,7 x 10 x 9,5 cm



F111

11 x 12,5 x 5 cm



F181

6,5 x 10,5 x 15 cm



F126

6,5 x 5 x 5 cm

F21/35

38,5 x 7,5 x 5 cm



F21/60

64,5 x 7 x 5 cm



F119/55

52 x 13 x 5 cm

7,5
kg



F123

36,9 x 4,8 x 5,6 cm



F124

15,5 x 7 x 5 cm



F133

ø 7,5 x 33 cm



F170

15,5 x 5 x 18,5 cm



F125

12,6 x 5,5 x 14 cm

G·GENZIANA

Realizzata in acciaio e Cromall® con contenitori in vetro satinato
 Made of steel and Cromall® with satinized glass containers
 Réalisée en acier et Cromall® avec boîtiers en verre satiné
 Hergestellt aus Stahl und Cromall® mit Behältern aus satiniertem Glas
 Realizada en acero y Cromall® con contenedores en cristal satinado
 Изготовлено из стали и Cromall® с ёмкостями из матового стекла

13
 Cromato
 Chromed



GE10
 6,7 x 11 x 9,5 cm



GE11
 10,8 x 13 x 3,8 cm



GE80
 7,5 x 11,5 x 17 cm



GE26
 6,5 x 5,5 x 3,8 cm

GE21/35
 39,2 x 5,5 x 3,8 cm



GE21/45
 45 x 5,5 x 3,8 cm



GE21/60
 57,5 x 5,5 x 3,8 cm



GE33
 ø 7,5 x 33 cm



GE19/55
 13 x 6 x 52 cm

8,5
 kg



GE70
 16 x 5,7 x 17 cm



GE24
 16,6 x 6,5 x 3,8 cm

G•HOT

Realizzata in metallo e resine termoplastiche
 Made of metal and thermoplastic resins
 Réalisée en métal and thermoplastique
 Hergestellt aus Metall und Kunststoff
 Realizada en metal y resinas termoplásticas
 Изготовлено из металла и термопластичных смол

13

Cromato
 Chromed



Solo su superfici lisce (specchi, piastrelle)
 For flat surfaces (mirrors, tiles) only
 Fissaggio con ventosa - Suction cup fixing
 Fixation avec ventouses - Befestigung mit Saugnäpfen
 Fijación con ventosas - Крепление при помощи присосок



HO20
 27,5 x 13,6 x 12 cm 



HO80
 19 x 19 x 10 cm 



HO26
 6,3 x 4,5 x 10,8 cm



HO08
 15 x 27 max x 22 cm



HO52
 10,7 x 12 x 22 cm



HO70
 16 x 4 x 22 cm



HO21/30
 28,2x5,5x15,3 cm



HO24
 16 x 6 x 15,5 cm

G·MONTANA

Design: R. & S. Prodotto Gedy

Realizzata in legno con contenitori in ceramica
Made of wood with pottery containers
Réalisée en bois avec boîtiers en céramique
Hergestellt aus Holz mit Behältern aus Keramik
Realizada en madera con contenedores en cerámica
Изготовлено из дерева с ёмкостями из керамики

95

Noce anticato
Old walnut
colour



8110

17 x 12 x 13,3 cm



8111

17 x 12 x 7,4 cm



8181

17 x 12 x 17 cm



8133

17 x 14,9 x 43,2 cm



8133/03

17 x 12 x 40,3 cm

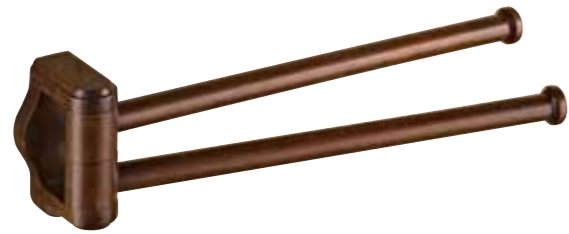

8123

37,8 x 7,5 x 11,5 cm



8126

17 x 2,2 x 7,4 cm

8121/35

35 x 8,5 x 7,4 cm



8121/45

45 x 8,5 x 7,4 cm



8121/60

60 x 8,5 x 7,4 cm



8119/55

55 x 11,5 x 7,4 cm



8170

22 x 8,6 x 15,2 cm



8125

17 x 12 x 13,9 cm

Legno/metallo - Wood/metal
Bois/métal - Holz/Metall
Madera/metal - Дерево/металл



8109 L.4

20,9 x 17,8 x 32,5 cm

Portarifiuti

Waste bin - Poubelle - Papierkorb
Papelera - Ведро для мусора

Legno, MDF
e resine termoplastiche

Wood, MDF
and thermoplastic resins
Bois, MDF et thermoplastique
Holz, MDF und Kunststoff
Madera, DM y resinas termoplasticas
Дерево, МДФ
и термопластичные смолы



8138

36,3 x 31,2 x 49,5 cm

Sgabello portabiancheria

Bin stool - Tabouret coffre à linge
Wäschebehälterhocker - Taburete contenedor ropa sucia
Табуретка ящика для грязного белья

Legno, MDF e tessuto

Wood, MDF and fabric
Bois, MDF et tissu
Holz, MDF und Stoff
Madera, DM y tejido
Дерево, МДФ и ткань



Sacchetto interno estraibile e lavabile
per la massima igiene
Fully removable and washable sack inside
for maximum hygiene
Sachet intérieur extractible et lavable pour
le maximum d'hygiène
Wäschebeutel, Innenteil abnehmbar und waschbar
für maximale Hygiene
Bolsita interna extraíble y lavable
para la máxima higiene
В целях гигиены внутренний пакет
можно извлечь и помыть

G·DARIOS

Realizzata in resine termoindurenti
 Made of thermosetting resins
 Réalisée en thermodurcissable
 Hergestellt aus Duroplast
 Realizada en resina termoestable
 Изготовлено из термореактивных смол

02

Bianco
 White



7210
 18 x 11,5 x 10 cm



7211
 18 x 11,5 x 3,5 cm



7226
 15 x 6 x 5 cm

7221/30
 32 x 11,5 x 3,5 cm



7221/60
 60 x 11,5 x 3,5 cm

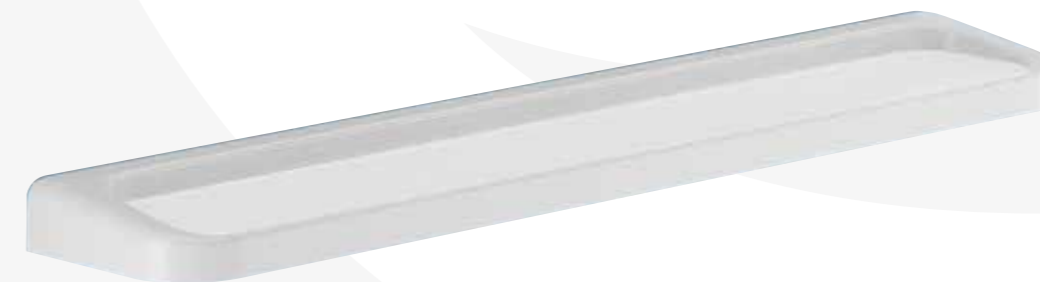

7219/60
 60 x 11,5 x 3,5 cm

6,5
 KG

7218
 32 x 11,5 x 3,5 cm

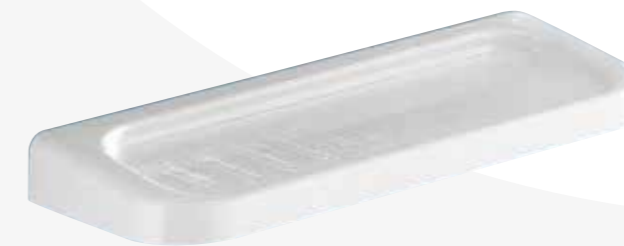

7224
 18 x 11,5 x 3,5 cm



7225
 14 x 15 x 12 cm
 resine termoplastiche - thermoplastic resins
 thermoplastique - Kunststoff - résinas
 termoplásticas - термопластиковые смолы



8034
 ø 12,5 x 33 cm
 Design: Gianpietro Tonetti
 resine termoplastiche - thermoplastic resins
 thermoplastique - Kunststoff
 résinas termoplásticas - термопластиковые смолы

G·WENDY

Design: Babled & Co.

Realizzata in resine termoplastiche
 Made of thermoplastic resins
 Réalisée en thermoplastique
 Hergestellt aus Kunststoff
 Realizada en resinas termoplásticas
 Изготовлено из термопластичных смол

02 89
 Bianco Bianco/blu
 White White/blue



Solo su superfici lisce (specchi, piastrelle)
 For flat surfaces (mirrors, tiles) only
 Fissaggio con ventosa - Suction cup fixing
 Fixation avec ventouses - Befestigung mit Saugnäpfen
 Fijación con ventosas - Крепление при помощи присосок

2
kg



7010
 8,3 x 12,8 x 13,5 cm



7011
 13,2 x 18,3 x 8,3 cm



7026
 8,3 x 9,5 x 8,3 cm

7021/45
 42,5 x 10,2 x 8,3 cm



7021/60
 61,3 x 10,2 x 8,3 cm



7024
 22,4 x 8,6 x 8,3 cm



7033
 ø 16,7 x 45 cm



pag. 195



pag. 178

G•2900

Design: Makio Hasuike

Realizzata in resine termoplastiche
Made of thermoplastic resins
Réalisée en thermoplastique
Hergestellt aus Kunststoff
Realizada en resinas termoplásticas
Изготовлено из термопластичных смол

02

Bianco
White



pag. 94

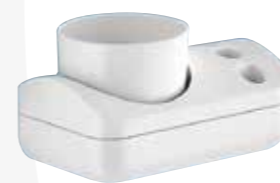

2910

15 x 12,5 x 8,5 cm



2911

15 x 12,5 x 4,5 cm



5027

4,5 x 4,5 x 8 cm



6027

4,9 x 4,2 x 10,5 cm

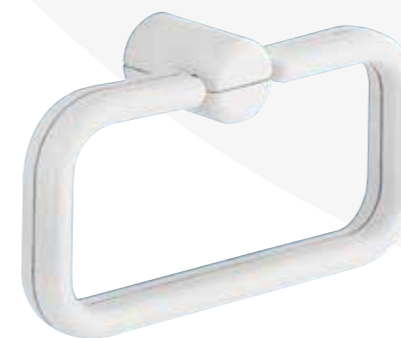

2970

24,5 x 7 x 13 cm



2033

ø 15 x 33,5 cm

2921/30
30 x 7 x 4,6 cm



2921/60
60 x 7 x 4,6 cm



2919/60
66 x 14 x 4,6 cm



2919/45
44,5 x 12 x 2,6 cm



2924
17 x 12,5 x 5,7 cm

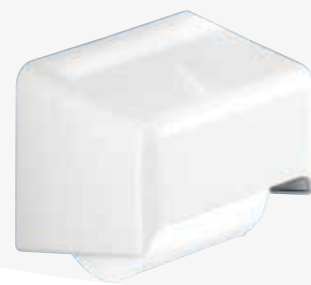

2925
14,5 x 13 x 12 cm



G•JUNIOR

Design: Gianpietro Tonetti

Realizzata in resine termoplastiche
 Made of thermoplastic resins
 Réalisée en thermoplastique
 Hergestellt aus Kunststoff
 Realizada en resinas termoplásticas
 Изготовлено из термопластичных смол

02

Bianco
 White



pag. 94



* Fissaggio con biadesivo o viti
 To be fixed with double-sided sticky tape or screws

Fixation avec adhésif double face ou vis - Befestigung mit doppelseitigem - Klebeband oder Schrauben
 Fijación con biadhesivo o tornillos - Крепление при помощи двухсторонней адгезивной ленты или шурупов



** Fissaggio con ventose o viti
 To be fixed with suction cups or screws

Fixation avec ventouses ou vis - Befestigung mit Saugnäpfen oder Schrauben
 Fijación con ventosas o tornillos - Крепление при помощи присосок или шурупов



8010**

15 x 12 x 6,5 cm



8011**

15 x 12 x 4 cm



8012**

30 x 12 x 4 cm



8034

ø 12,5 x 33 cm



8033

ø 13,5 x 39 cm

***8023**

40 x 3,2 x 15,7 cm



***8026**

2,8 x 2,6 x 6 cm



8028**

19,9 x 6,5 x 3 cm

8021/30**

30 x 10 x 4 cm



8021/55**

55 x 10 x 6,4 cm



8019/60**

60 x 12 x 4 cm

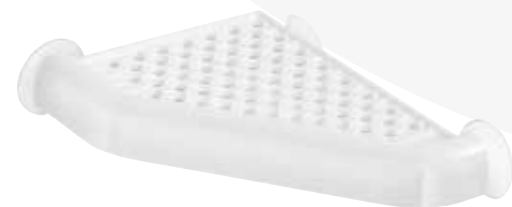

8080**

19,6 x 15,6 x 3 cm

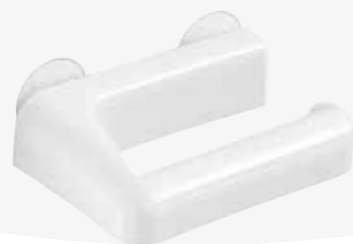

8024**

15 x 10,6 x 4 cm

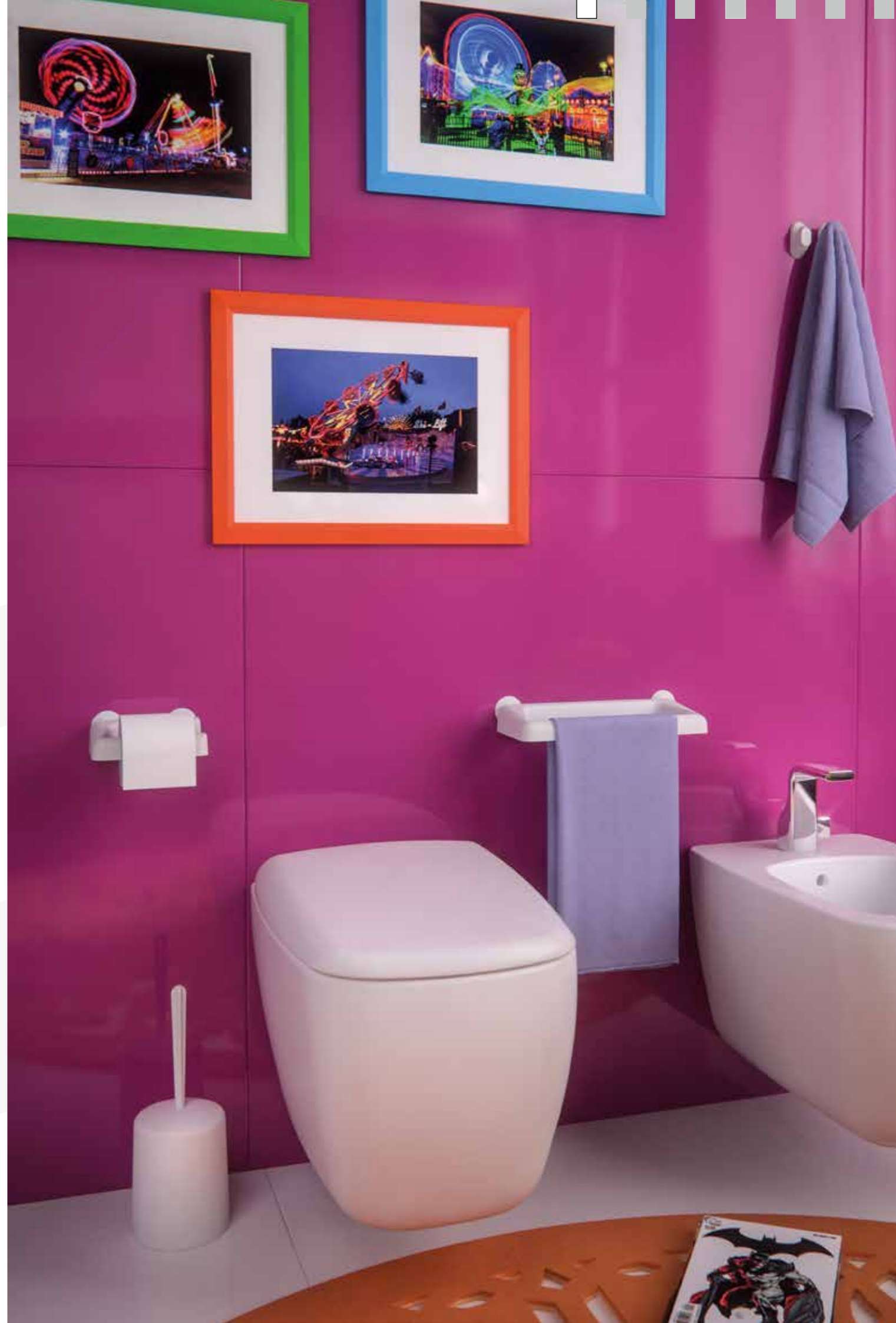

G•MINDY

Design: R. & S. Prodotto Gedy

Realizzata in resine termoplastiche
Made of thermoplastic resins
Réalisée en thermoplastique
Hergestellt aus Kunststoff
Realizada en resinas termoplásticas
Изготовлено из термопластичных смол

02

Bianco
White



Possibile fissaggio con biadesivo (venduto a parte)
Can be fixed with double-sided (sold separately)

Peut être fixé avec adhésif double (vendu séparément) - Kann mit Klebstoff fixiert (separat erhältlich)
Se puede fijar con biadhesivo (se vende por separado)
Может быть при помощи двухсторонней адгезивной ленты (продается отдельно)



8410

13,3 x 9 x 10,4 cm



8411

13,3 x 9 x 3,5 cm



8426

9,3 x 5,6 x 4,1 cm

8421/30

33,4 x 9 x 3,5 cm



8421/50

53,4 x 9 x 3,5 cm



8424

16 x 9 x 3,5 cm





BEAUTY

BEAUTY

Specchi senza cornice

Mirrors without frame - Miroirs sans cadre - Spiegel ohne Rahmen
 Espejos sin marco - Зеркало без краями



8401 G•DAKOTA

Design: Carlo Vietri
 50 x 6 x 65 cm

Specchio filo lucido con luci
 Polished edge mirror with lights
 Miroir bord poli avec éclairages
 Spiegel mit polierter Kante mit Beleuchtung
 Espejo canto pulido con luces
 Зеркало с полированными краями
 со светил ником

CE
 IP 20 
 W25 - E14



8400 G•DAKOTA

Design: Carlo Vietri
 50 x 2 x 65 cm

Specchio filo lucido
 Polished edge mirror
 Miroir bord poli
 Spiegel mit polierter Kante
 Espejo canto pulido
 Зеркало с полированными краями

Montabile anche in posizione orizzontale - Horizontally mountable also
 Montable aussi en position horizontale
 Horizontal aufhängbar auch - Montable horizontalmente también
 Монтаж тоже в горизонтальном положении



2575

75 x 2 x 55 cm

Specchio filo lucido
 Polished edge mirror
 Miroir bord poli
 Spiegel mit polierter Kante
 Espejo canto pulido
 Зеркало с полированными краями

2585

75 x 2 x 55 cm

Specchio bisellato
 Bevelled mirror
 Miroir biseauté
 Spiegel mit Facettenschliff
 Espejo biselado
 Зеркало со скшенными краями

Montabile anche in posizione verticale - Upright mountable also
 Montable aussi en position verticale
 Senkrecht aufhängbar auch - Montable verticalmente también
 Монтаж тоже в вертикальном положении



2520

ø 65 x 2 cm

Specchio filo lucido
 Polished edge mirror
 Miroir bord poli
 Spiegel mit polierter Kante
 Espejo canto pulido
 Зеркало с полированными краями

2530

ø 65 x 2 cm

Specchio bisellato
 Bevelled mirror
 Miroir biseauté
 Spiegel mit Facettenschliff
 Espejo biselado
 Зеркало со скшенными краями

Specchi con cornice in vetro laccato

Mirrors with lacquered - Miroirs avec cadre laqué - Spiegel mit lackiertem
Espejos con marco lacado - Зеркало с лакированной рамой



2551

100 x 2 x 60 cm

Specchio filo lucido

Polished edge mirror

Miroir bord poli

Spiegel mit polierter Kante

Espejo canto pulido

Зеркало с полированными краями



2561

100 x 2 x 60 cm

Specchio bisellato

Bevelled mirror

Miroir biseauté

Spiegel mit Facettenschliff

Espejo biselado

Зеркало со скшенными краями



Montabile anche in posizione verticale - Upright mountable also
Montable aussi en position verticale
Senkrecht aufhängbar auch - Montable verticalmente también
Монтаж тоже в вертикальном положении



2540 50 x 2 x 80 cm

2550 60 x 2 x 70 cm

Specchio filo lucido

Polished edge mirror

Miroir bord poli - Spiegel mit polierter Kante

Espejo canto pulido

Зеркало с полированными краями



2545 50 x 2 x 80 cm

2560 60 x 2 x 70 cm

Specchio bisellato

Bevelled mirror - Miroir biseauté

Spiegel mit Facettenschliff - Espejo biselado

Зеркало со скшенными краями



Montabile anche in posizione orizzontale - Horizontally mountable also
Montable aussi en position horizontale
Horizontal aufhängbar auch - Montable horizontalmente también
Монтаж тоже в горизонтальном положении



7800 G•MAINE

Design: R. & S. Prodotto Gedy

60 x 3 x 70 cm

Specchio con bordo laccato

Mirror with lacquered frame

Miroir avec cadre laqué

Spiegel mit lackiertem Rahmen

Espejo con marco lacado

Зеркало с лакированной рамой



SGG **MIRALITE® REVOLUTION**
Lo specchio ecologico by
Eco friendly mirror by

Montabile anche in posizione orizzontale - Horizontally mountable also
Montable aussi en position horizontale
Horizontal aufhängbar auch - Montable horizontalmente también
Монтаж тоже в горизонтальном положении

Specchi con cornice in resine termoplastiche

Mirrors with frame made of thermoplastic resins - Miroirs avec cadre en thermoplastique
 Spiegel mit Rahmen aus Kunststoff
 Espejos con marco en resinas termoplásticas - Зеркало в рамке из термолластичных смол

02

Bianco
 White



2605

Design: R. & S. Prodotto Gedy
 60 x 6,6 x 70 cm

Specchio con luci
 Mirror with lights
 Miroir avec éclairage
 Spiegel mit Beleuchtung
 Espejo con luces
 Зеркало со светильником

CE
 IP 20 
 W25 - E14

2604

Design: R. & S. Prodotto Gedy
 60 x 6 x 70 cm

Specchio senza luci
 Mirror without lights
 Miroir sans éclairage
 Spiegel ohne Beleuchtung
 Espejo sin luces
 Зеркало без подсветки



6001

Design: R. & S. Prodotto Gedy
 ø 60 x 5 cm

Specchio con luci
 Mirror with lights
 Miroir avec éclairage
 Spiegel mit Beleuchtung
 Espejo con luces
 Зеркало со светильником

CE
 IP 20 
 W25 - E14

6000

Design: R. & S. Prodotto Gedy
 ø 60 x 5 cm

Specchio senza luci
 Mirror without lights
 Miroir sans éclairage
 Spiegel ohne Beleuchtung
 Espejo sin luces
 Зеркало без подсветки

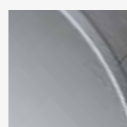

6005

Design: R. & S. Prodotto Gedy
 55 x 5 x 55 cm

Specchio con luci
 Mirror with lights
 Miroir avec éclairage
 Spiegel mit Beleuchtung
 Espejo con luces
 Зеркало со светильником

CE
 IP 20 
 W25 - E14

6004

Design: R. & S. Prodotto Gedy
 55 x 3 x 55 cm

Specchio senza luci
 Mirror without lights
 Miroir sans éclairage
 Spiegel ohne Beleuchtung
 Espejo sin luces
 Зеркало без подсветки



2903

Design: R. & S. Prodotto Gedy
 45 x 14,7 x 60 cm

Specchio con luci e mensola
 Mirror with lights and shelf
 Miroir avec éclairage et étagère
 Spiegel mit Beleuchtung und Ablage
 Espejo con luces y estante
 Зеркало со светильником и полочка

CE
 IP 20 
 W25 - E14

2901

Design: R. & S. Prodotto Gedy
 45 x 14,7 x 60 cm

Specchio con mensola
 Mirror with shelf
 Miroir avec étagère
 Spiegel mit Ablage
 Espejo con estante
 Зеркало со полочка

13

Finitura
lucida
Polished
finishing

Armadietti in acciaio inox

Cabinets made of stainless steel - Armoires en acier inoxydable - Schränkchen aus Edelstahl - Armarios en acero inox
Шкаф изготовлено из нержавеющей стали



2900

Design: R. & S. Prodotto Gedy
45 x 4 x 45 cm

Specchio senza luci
Mirror without lights
Miroir sans éclairage
Spiegel ohne Beleuchtung
Espejo sin luces
Зеркало без подсветки



8001

Design: Gianpietro Tonetti
55 x 5,5 x 60 cm

Specchio con luci
Mirror with lights
Miroir avec éclairage
Spiegel mit Beleuchtung
Espejo con luces
Зеркало со светильником

CE
IP 20 
W25 - E14

8000

Design: Gianpietro Tonetti
55 x 3,5 x 60 cm

Specchio senza luci
Mirror without lights
Miroir sans éclairage
Spiegel ohne Beleuchtung
Espejo sin luces
Зеркало без подсветки



2807*

Design: R. & S. Prodotto Gedy
51 x 11,5 x 65 cm

Con anta a specchio reversibile e 1 ripiano acciaio inox/vetro
With reversible mirror door and 1 shelf stainless steel/glass
Avec porte en glace réversible et 1 étagère acier inoxydable/verre
Mit reversibler Spiegeltür und 1 Ablage Edelstahl/Glas
Con puerta reversible y espejo y 1 repisa acero inox/cristal
С реверсивной зеркальной дверцей и 1 полочка нержавеющей стали/стекла

* Coordinabile con lampada 2842 (vedi pg. 98) - Coordinated lamp 2842 (see page 98) - Lampe coordonnée 2842 (voir la page 98) - Koordinierte Lampe 2842 (sehen Sie Seite 98) - Lámpara coordinada 2842 (vea la página 98) - Координируемые светильники 2842 (страницу 98)

SGG MIRALITE® REVOLUTION
Lo specchio ecologico by
Eco friendly mirror by

2806*

Design: R. & S. Prodotto Gedy
51 x 11,5 x 60 cm

Con anta a specchio reversibile e 1 ripiano acciaio inox/vetro
With reversible mirror door and 1 shelf stainless steel/glass
Avec porte en glace réversible et 1 étagère acier inoxydable/verre
Mit reversibler Spiegeltür und 1 Ablage Edelstahl/Glas
Con puerta reversible y espejo y 1 repisa acero inox/cristal
С реверсивной зеркальной дверцей и 1 полочка нержавеющей стали/стекла



02

Bianco
White

Armadietti in resine termoplastiche

Cabinets made of thermoplastic resins - Armoires en thermoplastique Schränkchen aus Kunststoff
Armarios en resinas termoplásticas - Шкаф изготовлено из термопластичных смол



KO07* G·KORA

46 x 12 x 66 cm

Armadietto reversibile con antina a specchio scorrevole - acciaio inox

Cabinet with sliding mirror door - stainless steel
Armoire reversible avec porte à miroir coulissante acier inoxydable

Schränkchen mit verschiebbarer Spiegeltür
Edelstahl

Armario reversible con puerta de espejo corredera - acero inox

Шкафчик с зеркальной раздвижной дверцей нержавеющей сталь

* Coordinabile con lampada 2842 (vedi pg. 98) - Coordinated lamp 2842 (see page 98) - Lampe coordonnée 2842 (voir la page 98) - Koordinierte Lampe 2842 (sehen Sie Seite 98) - Lámpara coordinada 2842 (vea la página 98) - Координируемые светильники 2842 (страницу 98)



JO07 G·JOKER

30 x 12 x 50 cm

JO35 G·JOKER

30 x 12 x 30 cm

Armadietti con anta in vetro, serratura di sicurezza e 1 ripiano - acciaio inox/vetro
Cabinets with glass door, safety lock and 1 shelf stainless steel/glass

Armoires avec porte en vitre, serrure de sécurité et 1 étagère - acier inox/verre

Schränkchen mit Glastür, Sicherheitsschloss und 1 Ablage - Edelstahl/Glas

Armarios con puerta de vidrio, cerradura de seguridad y 1 repisa - acero inoxidable/cristal

Шкафчик со стеклянной створкой, замком и 1 полочка - нержавеющей сталь/стекло



8047 G·PRINCESS

Design: R. & S. Prodotto Gedy

58,5 x 14 x 38 cm

Con 3 ante a specchio

With 3 mirror doors

Avec 3 portes en glace

Mit Spiegeltür

Con 3 puertas con espejo

С 3 зеркальными дверцами



8007 G·LILLIPUT

Design: Olaf Von Bohr

30 x 14,3 x 45 cm

SGG MIRALITE® REVOLUTION
Lo specchio ecologico by Eco friendly mirror by

Con anta a specchio

With mirror door - Avec porte en glace

Mit Spiegeltür - Con puerta con espejo

С зеркальной дверцей

8006 G·LILLIPUT

Design: Olaf Von Bohr

30 x 14,3 x 45 cm

Senza specchio

Without mirror - Sans miroir - Ohne Spiegel

Sin espejo - Без зеркальной створки



8035

Design: R. & S. Prodotto Gedy

25 x 12,5 x 39,5 cm

Armadietto farmacia con chiave

Medicine cabinet with key

Armoire à pharmacie avec clef

Arzneischrank mit Schlüssel

Botiquin con llave

Аптека закрывающаяся на ключ

illuminazione

Lighting - Luminaires - Licht im Bad - Iluminación - Лампы



2042 G·GIOVE

22,6 x 13,5 x 9,7 cm

Lampada alogena universale per specchi senza cornice - ottone/vetro
Lamp with halogen light for mirrors without frame - brass/glass
Applique avec lampe halogène pour miroirs sans cadre - laiton/verre
Leuchte mit Halogenlampe für Spiegel ohne Rahmen - Messing/Glas
Aplique con lámpara halógena para espejos sin marco - latón/cristal
Чниверсальная галотенная лампа для зеркал без рамки - латунь/стекло

13

Cromato lucido
Chromed

CE
IP 23
W75 - R75



2842

22,6 x 12,7 x 14,1 cm

Lampada alogena per armadietti 2806, 2807 e KO07 - ottone/vetro
Lamp with halogen light for cabinets 2806, 2807 and KO07 - brass/glass
Applique avec lampe halogène pour armoires 2806, 2807 et KO07 - laiton/verre
Leuchte mit Halogenlampe für Schränkchen 2806, 2807 und KO07 - Messing/Glas
Aplique con lámpara para armarios 2806, 2807 y KO07 - latón/cristal
Чниверсальная галотенная лаппа для шкаф 2806, 2807 и KO07 - латунь/стекло

13

Cromato lucido
Chromed

CE
IP 23
W75 - R75



2041 G·VENERE

8,5 x 16,5 x 21 cm

Applique universale per specchi senza cornice (predisposta per lampadina ad incandescenza) - ottone/vetro
Lamp for mirrors without frame (incandescent bulb) - brass/glass
Applique pour miroirs sans cadre (ampoule à incandescence) - laiton/verre
Spiegelleuchte für Spiegel ohne Rahmen (Glühbirne) - Messing/Glas
Aplique para espejos sin marco (bombilla normal) - latón/cristal
Чниверсальный светильник для зеркал без рамки (под лдмпч накаливания) латунь/стекло

02

Cromato/bianco
Chromed/white

CE
IP 23
W40 - E14



2043 G·NETTUNO

7 x 12-24 x 36,5 cm

Lampada da parete con sostegno orientabile (predisposta per lampadina ad incandescenza) ottone/vetro
Wall lamp with adjustable support (incandescent bulb) - brass/glass
Applique murale avec support orientable (ampoule à incandescence) - laiton/verre
Wandlampe mit ausrichtbarem Halter (Glühbirne) Messing/Glas
Aplique de pared con soporte orientable (bombilla normal) - latón/cristal
Настенная лампа с ориентируемой основой (под лампц накаливания) - латунь/стекло

02

Cromato/bianco
Chromed/white

CE
IP 23
W40 - E14

Specchi ingranditori

Magnifying mirrors - Miroirs grossissants - Kosmetikspiegel
Espejos de aumento - Увеличительные зеркала



HO08 G•HOT

15 x 27max x 22 cm

13

Cromato lucido
Chromed

SOLO SU SUPERFICI LISCE E NON POROSE
SMOOTH AND NOT POROUS SURFACES ONLY

Specchio ingranditore e non, con fissaggio a ventosa - resine termoplastiche/metallo

Magnifying and not magnifying mirror with suction cup fixing - thermoplastic resins/metal
Miroir grossissant et non grossissant avec ventouse thermoplastique/métal

Spiegel mit und ohne Vergrößerung - mit Saugnapf aufhängbar - Kunststoff/Metall

Espejo de aumento y normal - fijación con ventosa - resinas termoplásticas/metal

Авчстороннее чвеличительное и обычное зеркало на присоска - термопластичные смоли/металл



CO2020

ø 15 x 3 cm

13

Cromato lucido
Chromed

SOLO SU SUPERFICI LISCE E NON POROSE
SMOOTH AND NOT POROUS SURFACES ONLY

Specchio ingranditore con ventose metallo/vetro

Magnifying mirror with suction cups - metal/glass

Miroir grossissant avec ventouses - métal/verre

Vergrößerungsspiegel mit Saugnapfen aufhängbar - Metall/Glas

Espejo agrandador con ventosas - metal/cristal

Увеличительное зеркало на присосках металл/стекло



CO2021

ø 20 x 3 cm

13

Cromato lucido
Chromed

SOLO SU SUPERFICI LISCE E NON POROSE
SMOOTH AND NOT POROUS SURFACES ONLY

Specchio ingranditore con ventose metallo/vetro

Magnifying mirror with suction cups - metal/glass

Miroir grossissant avec ventouses - métal/verre

Vergrößerungsspiegel mit Saugnapfen aufhängbar - Metall/Glas

Espejo agrandador con ventosas - metal/cristal

Увеличительное зеркало на присосках металл/стекло



CO2019

20 x 21 x 6 cm

Ingranditore e non - metallo

Magnifying and not magnifying - metal

Grossissant et non grossissant - métal

Mit und ohne Vergrößerung - Metall

De aumento y normal - metal

Двустороннее увеличительное и не

увеличительное зеркало - металл

13

Cromato lucido
Chromed



CO2023 G•MONICA

17 x 3,8 x 17,5 cm

Ingranditore e non - metallo

Magnifying and not magnifying - metal

Grossissant et non grossissant - métal

Mit und ohne Vergrößerung - Metall

De aumento y normal - metal

Двустороннее увеличительное и не

увеличительное зеркало - металл

02

Bianco
White

13

Cromato
Chromed

79

Lilla
Lilac

Bilancia pesapersona elettronica

Electronic bathroom scale - Pèse-personne électronique - Elektronische Personenwaage
Báscula pesa-personas electrónica Весы электронные напольные

G•RAINBOW

Design: R. & S. Prodotto Gedy

Realizzata in vetro, metallo e resine termoplastiche

Made of glass, metal and thermoplastic resins - Réalisé en verre, métal et thermoplastique
Hergestellt aus Glas, Metall und Kunststoff - Realizado en cristal, metal y resinas termoplásticas
Изготовлено из стекла, металла и термопластичных смол

02	04	05
Bianco White	Verde Green	Blu Blue
14	67	73
Nero Black	Arancio Orange	Argento Silver



RA90

34 x 27,4 x 2,7 cm

5x



CO2022 G-ELENA

16,5 x 1,8 x 19 cm

Ingranditore e non - resine termoplastiche
Magnifying and not magnifying
thermoplastic resins
Grossissant et non grossissant - thermoplastique
Mit und ohne Vergrößerung - Kunststoff
De aumento y normal - resinas termoplásticas
Двустороннее увеличительное и обычное
зеркало - термопластичная смола

02	76	92
Bianco White	Fucsia Fuchsia	Turchese Turquoise

2x



CO2018

17,6 x 10 x 25 cm

Ingranditore e non - resine termoplastiche
Magnifying and not magnifying
thermoplastic resins
Grossissant et non grossissant - thermoplastique
Mit und ohne Vergrößerung - Kunststoff
De aumento y normal - resinas termoplásticas
Двустороннее увеличительное и обычное
зеркало - термопластичная смола

00	05	79
Trasparente Transparent	Blu Blue	Lilla Lilac

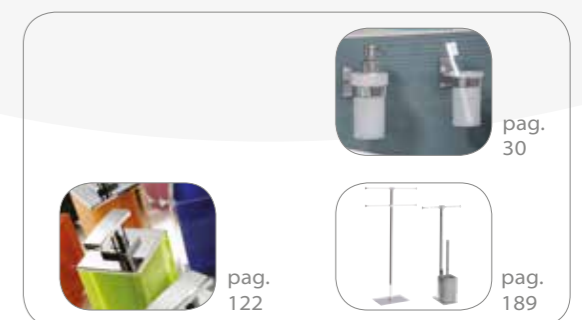



TABLE TOP

TABLE TOP

G·ALTEA

Realizzata in bambù e resine termoplastiche
 Made of bamboo and thermoplastic resins
 Réalisée en bambou et thermoplastique
 Hergestellt aus Bambus und Kunststoff
 Realizada en bambú y resinas termoplásticas
 Изготовлено из бамбука и термопластиченых смол

35

Naturale
 Natural



AL98

ø 7 x 12 cm



AL11

ø 11,7 x 2 cm



AL80

7 x 10,3 x 17,2 cm



AL33

ø 8,5 x 47,5 cm



ER98

ø 7,1 x 11 cm



ER11

ø 11,5 x 1,9 cm



ER81

ø 7,2 x 16,4 cm



ER33

ø 8,9 x 36 cm

30

Noce
 Walnut
 colour

G·BAMBÙ

Realizzata in bambù
 Made of bamboo
 Réalisée en bambou
 Hergestellt aus Bambus
 Realizada en bambú
 Изготовлено из бамбука

35

Naturale
 Natural



BA98

7,4 x 7,4 x 11 cm



BA11

13,4 x 9,6 x 2,5 cm



BA81

7,4 x 7,4 x 16,8 cm



BA33

10 x 10 x 36,5 cm

G•NEMESIA

Realizzata in acciaio inox
 Made of stainless steel
 Réalisée en acier inoxydable
 Hergestellt aus Edelstahl
 Realizada en acero inox
 Изготовлено из нержавеющей стали

13
 Finitura
 lucida
 Polished
 finishing



NE98
 6 x 6 x 10 cm



NE1
 11,8 x 11,8 x 2 cm



NE81
 6 x 6 x 18 cm



NE33
 9 x 9 x 38 cm



NE33-O3
 9 x 9,5 x 38 cm



PL98
 10,2 x 4,5 x 10 cm



PL11
 12,6 x 10,2 x 2,5 cm



PL80
 10,2 x 4,5 x 14,9 cm



PL33
 12,5 x 9,5 x 39 cm

G•POLARIS

Realizzata in acciaio inox
 Made of stainless steel
 Réalisée en acier inoxydable
 Hergestellt aus Edelstahl
 Realizada en acero inox
 Изготовлено из нержавеющей стали

13
 Finitura
 lucida
 Polished
 finishing



G·NAOS

Realizzata in acciaio inox
 Made of stainless steel
 Réalisée en acier inoxydable
 Hergestellt aus Edelstahl
 Realizada en acero inox
 Изготовлено из нержавеющей стали

38

Finitura
 spazzolata
 Brushed
 finishing



NA98
 ø 6,6 x 9,9 cm



NA11
 ø 11 x 2,1 cm



NA80
 ø 5,5 x 18,7 cm



NA33
 ø 10 x 37,5 cm

G·PRIMULA

Realizzata in acciaio inox
 Made of stainless steel
 Réalisée en acier inoxydable
 Hergestellt aus Edelstahl
 Realizada en acero inox
 Изготовлено из нержавеющей стали

21

finitura
 lucida/
 spazzolata
 polished/
 mat
 finishing



PR98
 ø 7 x 10 cm



PR11
 ø 11,2 x 2 cm



PR81
 ø 5,5 x 19 cm



PR33
 ø 10 x 38 cm

G·NIGELLA

Realizzata in acciaio inox
 Made of stainless steel
 Réalisée en acier inoxydable
 Hergestellt aus Edelstahl
 Realizada en acero inox
 Изготовлено из нержавеющей стали

38

Finitura
 spazzolata
 Brushed
 finishing



NI98
 ø 9 x 10 cm



NI81
 ø 9 x 15,5 cm



NI33
 ø 13 x 39 cm

G • FORSIZIA

Realizzata in vetro e resine termoplastiche
 Made of thermoplastic resins and glass
 Réalisée en thermoplastique et verre
 Hergestellt aus Kunststoff und Glas
 Realizada en resinas termoplásticas y cristal
 Изготовлено из термопластиченых смол и стекла

02 73 79
 Bianco Argent Lilla
 White Silver Lilac



FO98
9,9 x 8 x 13 cm



FO11
ø 12 x 2,9 cm



FO80
9,9 x 8 x 16,6 cm



FO33
10,4 x 7,9 x 39,3 cm



5010
9,5 x 8,5 x 13,5 cm



5011
13,8 x 12 x 3 cm



5081
15,4 x 11,3 x 11,6 cm



5033
12,5 x 11,5 x 36 cm

G • STONE

Design: Lucidi_Pevere

Realizzata in ceramica
 Made of pottery
 Réalisée en céramique
 Hergestellt aus Keramik
 Realizada en cerámica
 Изготовлено из керамики

03 29
 Beige Moka



G·JAMILA

Design: Studiopoco

Realizzata in ceramica
Made of pottery
Réalisée en céramique
Hergestellt aus Keramik
Realizada en cerámica
Изготовлено из керамики



02
Bianco
White



1698
7,5 x 7,5 x 12 cm



1611
13,7 x 10 x 2,6 cm



1681
7,5 x 7,5 x 19 cm



1633
11 x 11 x 36 cm



G·MYOSOTIS

Realizzata in ceramica e vetro
Made of pottery and glass
Réalisée en céramique et verre
Hergestellt aus Keramik und Glas
Realizada en cerámica y cristal
Изготовлено из керамики и стекла

73 87
Grigio/
argento
Grey/
silver Oro
Gold



MY98
ø 9 x 11,8 cm



MY11
15,3 x 11 x 5 cm



MY80
ø 8,8 x 19,6 cm



MY33
ø 11,8 x 33,5 cm



4798
7,3 x 7,3 x 10,9 cm



4711
9,5 x 9,5 x 2,6 cm



4780
7,3 x 7,3 x 15 cm



4733
8,5 x 8,5 x 36,5 cm

G·MARTINA

Realizzata in ceramica
Made of pottery
Réalisée en céramique
Hergestellt aus Keramik
Realizada en cerámica
Изготовлено из керамики

05 42 73
Blu Bianco Argento
petrolio White Silver
Blue



G•MUGHETTO

Realizzata in ceramica
 Made of pottery
 Réalisée en céramique
 Hergestellt aus Keramik
 Realizada en cerámica
 Изготовлено из керамики

29 Moka
85 Antracite
 Anthracite

Soft TOUCH



MU98
 ø 9 x 12,6 cm



MU11
 ø 11,9 x 2,6 cm



MU80
 ø 7,6 x 23 cm



MU33
 ø 11,4 x 39 cm

G•MIZAR

Realizzata in ceramica
 Made of pottery
 Réalisée en céramique
 Hergestellt aus Keramik
 Realizada en cerámica
 Изготовлено из керамики

08 Grigio
 Grey
11 Azzurro
 Light blue
52 Tortora
 Turtledove grey
63 Viola
 Purple
70 Azalea
 Azalea
92 Turchese
 Turquoise

Soft TOUCH



MZ98
 ø 6,4 x 11,7 cm



MZ11
 ø 11,5 x 2,6 cm



MZ80
 ø 6,4 x 20,3 cm



MZ33
 ø 10,4 x 41 cm

G•AZALEA

Realizzata in ceramica e resine termoplastiche
 Made of pottery and thermoplastic resins
 Réalisée en céramique et thermoplastique
 Hergestellt aus Keramik und Kunststoff
 Realizada en cerámica y resinas termoplásticas
 Изготовлено из керамики и термопластичных смол

02 05 75 79
 Bianco Blue Lavanda Lilla
 White Blue Lavender Lilac



G•PETUNIA

Realizzata in ceramica e acciaio inox
 Made of pottery and stainless steel
 Réalisée en céramique et acier inoxydable
 Hergestellt aus Keramik und Edelstahl
 Realizada en cerámica y acero inox
 Изготовлено из керамики и нержавеющей стали

02
 Bianco
 White



AZ98
 ø 9,8 x 13 cm



AZ11
 12,4 x 9 x 2,7 cm



AZ80
 ø 10,2 x 17 cm



AZ33
 ø 16,5 x 40,3 cm



PE98
 ø 7,5 x 9,5 cm



PE1
 12,5 x 8,5 x 3,5 cm



PE81
 ø 7,5 x 16,5 cm

G•DALIA

Realizzata in ceramica
 Made of pottery
 Réalisée en céramique
 Hergestellt aus Keramik
 Realizada en cerámica
 Изготовлено из керамики

02
 Bianco
 White



G•VERBENA

Realizzata in ceramica
 Made of pottery
 Réalisée en céramique
 Hergestellt aus Keramik
 Realizada en cerámica
 Изготовлено из керамики

02
 Bianco
 White



DA98
 ø 8,1 x 10,6 cm



DA11
 ø 12,5 x 3,2 cm



DA80
 ø 9 x 17,8 cm



DA33
 ø 12,5 x 38 cm



VE98
 6,5 x 6,5 x 10 cm



VE1
 11,5 x 8,5 x 2,5 cm



VE81
 6,5 x 6,5 x 16,5 cm



G·TWIST

Design: Babled & Co.

Realizzata in resina
 Made of resin
 Réalisée en résine
 Hergestellt aus Harz
 Realizada en resina
 Изготовлено из смол

- | | | |
|-------------------------------------------------------|------------------------------------------------------|-----------------------------|
| 22
Bianco
White | 73
Argento
Silver | 79
Lilla
Lilac |
| S2
Bianco
satinato
Satinized
white | S9
Ambra
satinato
Satinized
amber | |



4698
8,5 x 8,5 x 12 cm



4611
13 x 9 x 3,5 cm



4680
8,5 x 8,5 x 16 cm



4681
8,5 x 8,5 x 17,5 cm



4633
12 x 13,5 x 47 cm

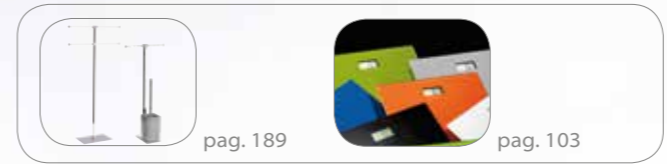

G·RAINBOW

Realizzata in resina
 Made of resin
 Réalisée en résine
 Hergestellt aus Harz
 Realizada en resina
 Изготовлено из смол

- | | | | | |
|--------------------------------|-------------------------------------------|--------------------------------|-----------------------------|----------------------------|
| 02
Bianco
White | 04
Verde
Acido
Acid green | 05
Blue
Blue | 06
Rosso
Red | 14
Nero
Black |
| 67
Arancio
Orange | 73
Argento
Silver | 76
Fucsia
Fuchsia | 79
Lilla
Lilac | |

cambiare colore da viola ad argento



nei pezzi scontornati inserire il colore viola

- | | | | | | | | | | |
|----------------------------------|-------------------------------------|------------------------------------|-----------------------------------------|----------------------------------|------------------------------|-----------------------------------|--------------------------------|----------------------------------|------------------------------------|
| | | | | | | | | | |
| RA00*
19 x 11 x 7,5 cm | RA02*
14,5 x 14,5 x 15 cm | RA08*
25 x 13,5 x 7,5 cm | RA09*
L 6 - 18 x 18 x 23,7 cm | RA98
7,2 x 7,2 x 11 cm | RA11
11 x 7 x 3 cm | RA80
7 x 11,3 x 16,2 cm | RA81
7 x 7 x 16,2 cm | RA82
6,9 x 6,9 x 15 cm | RA33
9,8 x 9,8 x 37,5 cm |

*Realizzato in resine termoplastiche - Made of thermoplastic resins - Réalisé en thermoplastique
 Hergestellt aus Kunststoff - Realizado en resinas termoplásticas - Изготовлено из термопластических смол

G•VEGA

Realizzata in resina
 Made of resin
 Réalisée en résine
 Hergestellt aus Harz
 Realizada en resina
 Изготовлено из смол

- 02 Bianco White
- 73 Argento Silver
- 79 Lilla Lilac



VG98
 ø 7 x 12 cm



VG11
 ø 11 x 2,5 cm



VG80
 7 x 15,7 cm



VG33
 10 x 37 cm

G•ANTARES

Realizzata in resina
 Made of resin
 Réalisée en résine
 Hergestellt aus Harz
 Realizada en resina
 Изготовлено из смол

- 11 Azzurro Light blue
- 53 Rubino Ruby red
- 67 Arancio Orange
- 79 Lilla Lilac
- 92 Turchese Turquoise
- S2 Bianco satinato Satinized white



AT98
 8 x 5,9 x 12 cm



AT11
 12 x 7,8 x 3 cm



AT80
 7,8 x 5,7 x 16 cm



AT33
 9 x 8,6 x 48,5 cm

G•MELISSA

Realizzata in resina
Made of resin
Réalisée en résine
Hergestellt aus Harz
Realizada en resina
Изготовлено из смол



73

Trasparente
argento
Transparent
silver

87

Trasparente
ambra
Transparent
amber



MA98

ø 7,6 x 10,7 cm



MA11

14,5 x 9,8 x 2,4 cm



MA81

ø 7,6 x 23 cm



MA33

ø 11 x 38 cm

G•MAGNOLIA

Realizzata in resina
Made of resin
Réalisée en résine
Hergestellt aus Harz
Realizada en resina
Изготовлено из смол



44

Bronzo
oro/
Bronze
gold



ME98

ø 8,3 x 10,6 cm



ME11

14,3 x 10 x 2,4 cm



ME80

ø 12 x 15 cm



ME33

ø 11,3 x 35 cm

G•LIBRA

Realizzata in resina
Made of resin
Réalisée en résine
Hergestellt aus Harz
Realizada en resina
Изготовлено из смол

03

Beige



LI98

ø 10,2 x 10,4 cm

LI11

12,3 x 9 x 2,7 cm

LI80

ø 10,6 x 15,5 cm

LI33

ø 12,2 x 40 cm

G•ARIES

Realizzata in resina e sabbia
 Made of resin and sand
 Réalisée en résine et sable
 Hergestellt aus Harz und Sand
 Realizada en resina y arena
 Изготовлено из смол и песка

- 03**
Beige
- 08**
Grigio
Grey
- 85**
Antracite
Anthracite



AR98
9,2 x 6,5 x 11 cm



AR11
12,2 x 8,6 x 2,4 cm



AR80
9 x 6,4 x 16,8 cm



AR33
10,5 x 10,5 x 40 cm



ID98
ø 10,2 x 10,4 cm



ID11
12,3 x 9 x 2,7 cm



ID80
ø 10,6 x 15,5 cm



ID33
ø 12,2 x 40 cm

G•IDRA

Realizzata in resina
 Made of resin
 Réalisée en résine
 Hergestellt aus Harz
 Realizada en resina
 Изготовлено из смол

- 03**
Beige
- 08**
Grigio
Grey



G•AURIGA

Realizzata in resina
 Made of resin
 Réalisée en résine
 Hergestellt aus Harz
 Realizada en resina
 Изготовлено из смол

03 Beige
30 Noce
 Walnut
 colour



AG98
 ø 7,5 x 9,9 cm



AG11
 ø 10 x 2,4 cm



AG80
 ø 7,3 x 16,2 cm



AG33
 ø 10,6 x 40 cm

G•AQUARIUS

Realizzata in resina
 Made of resin
 Réalisée en résine
 Hergestellt aus Harz
 Realizada en resina
 Изготовлено из смол

03
 Beige



AQ98
 8,5 x 8,5 x 10,3 cm



AQ11
 12,7 x 12,7 x 2,8 cm



AQ80
 8,9 x 8,6 x 18 cm



AQ33
 10,9 x 10,7 x 40 cm

G·GEMINI

Realizzata in resina
 Made of resin
 Réalisée en résine
 Hergestellt aus Harz
 Realizada en resina
 Изготовлено из смол

02 08 52
 Bianco Grigio Tortora
 White Grey Turtledove
 grey



GM98
 ø 8,8 x 10,9 cm



GM11
 14,4 x 9,8 x 2,8 cm



GM80
 9,3 x 8,8 x 20 cm



GM33
 ø 10 x 45,7 cm



OR98
 ø 7,5 x 11 cm



OR11
 ø 11,2 x 2,5 cm



OR81
 7,5 x 9,4 x 17,2 cm



OR33
 ø 9,5 x 47 cm

G·ORTENSIA

Realizzata in resina e Cromall®
 Made of resin and Cromall®
 Réalisée en résine et Cromall®
 Hergestellt aus Harz und Cromall®
 Realizada en resina y Cromall®
 Изготовлено из смолы и Cromall®

02 38 63
 Bianco Argento Viola
 White Silver Purple



G·SOLE

Realizzata in resina
 Made of resin
 Réalisée en résine
 Hergestellt aus Harz
 Realizada en resina
 Изготовлено из смолы

- 04 Verde acido / Acid green
- 10 Rosa / Pink
- 11 Azzurro / Light blue
- 67 Vinaccia / Purple
- 67 Arancio / Orange



SL98
 ø 7,2 x 12,2 cm



SL11
 ø 11 x 2,7 cm



SL80
 ø 7,2 x 15,6 cm



SL33
 ø 9,6 x 37 cm

G·QUADROTTO

Realizzata in resina
 Made of resin
 Réalisée en résine
 Hergestellt aus Harz
 Realizada en resina
 Изготовлено из смолы

- 02 Bianco / White
- 14 Nero / Black



QU98
 10,2 x 6,2 x 11,5 cm



QU11
 11,7 x 11,7 x 2,7 cm



QU81
 8,2 x 8,2 x 16 cm



QU33
 9,5 x 9,5 x 38 cm

G·ETNICA

Realizzata in resina
 Made of resin
 Réalisée en résine
 Hergestellt aus Harz
 Realizada en resina
 Изготовлено из смолы

- 29



ET98
 ø 8 x 10,4 cm



ET11
 12,6 x 8,2 x 2,2 cm



ET81
 ø 7,9 x 15,7 cm



ET33
 ø 10 x 36 cm

G·LUNA

Realizzata in resine termoplastiche
 Made of thermoplastic resins
 Réalisée en thermoplastique
 Hergestellt aus Kunststoff
 Realizada en resinas termoplásticas
 Изготовлено из термопластиченых смол

05 Blu Blue
 14 Nero Black
 73 Argento Silver

Soft TOUCH



LU98
 ø 7,2 x 12,9 cm



LU11
 ø 11,5 x 2,4 cm



LU80
 ø 7,2 x 15,2 cm



LU33
 ø 8,7 x 47 cm



1798
 ø 10,2 x 11,2 cm



1711
 ø 13,8 x 12,5 x 4 cm



1780
 ø 11 x 19 cm



1733
 ø 12,6 x 36 cm

G·FLOU

Design: Carallo_Grandis

Realizzata in resine termoplastiche
 Realizzata in resine termoplastiche
 Made of thermoplastic resins
 Réalisée en thermoplastique
 Hergestellt aus Kunststoff
 Realizada en resinas termoplásticas
 Изготовлено из термопластиченых смол

02 Bianco White
 67 Viola trasparente Transparent purple
 05 Turchese trasparente Transparent turquoise



G•MOBY

Design: Babled & Co.

Realizzata in resine termoplastiche
 Realizzata in resine termoplastiche
 Made of thermoplastic resins
 Réalisée en thermoplastique
 Hergestellt aus Kunststoff
 Realizada en resinas termoplásticas
 Изготовлено из термопластичных смол

02	49	60	89	93
Bianco/ white White/ white	Bianco/ lilla White/ lilac	Bianco/ verde White/ green	Bianco/ blu White/ blue	Bianco/ arancio White/ orange



3198

8,6 x 8,2 x 11,5 cm



3111

14,9 x 12 x 5,5 cm



3180

11,3 x 12,9 x 14,3 cm



3133

11,1 x 10,9 x 37,8 cm

G•GLADY

Realizzata in resine termoplastiche
 Realizzata in resine termoplastiche
 Made of thermoplastic resins
 Réalisée en thermoplastique
 Hergestellt aus Kunststoff
 Realizada en resinas termoplásticas
 Изготовлено из термопластичных смол

00	02	04	14	67	76	79	92
Trasparente Transparent	Bianco White	Verde acido Acid green	Nero Black	Arancio Orange	Fucsia Fuchsia	Lilla Lilac	Turchese Turquoise



GLOO

18,5 x 10,5 x 7,5 cm



GL98

ø 8,5 x 11 cm



GL11

13 x 8 x 4 cm



GL80

ø 8,5 x 17 cm



GL33

ø 13,2 x 37 cm



GLO9 L6,6

ø 21,1 x 25,4 cm

nei pezzi scontornati inserire colore più vivo

G·SEVENTY

Design: Matteo Thun

Realizzata in resine termoplastiche
Made of thermoplastic resins - Réalisée en thermoplastique
Hergestellt aus Kunststoff - Realizada en resinas termoplásticas
Изготовлено из термопластиченых смол

08	11	22	52	79
Grigio Grey	Azzurro Light blue	Bianco White	Tortora Turtledove gray	Lilla Lilac



6398

6,5 x 6,5 x 12,2 cm



6311

14 x 9 x 2,6 cm



6382

6,5 x 6,5 x 16 cm



6334

9 x 9 x 38,8 cm



HYGIENE

HYGIENE

Cestini in acciaio inox

Waste bins of stainless steel - Poubelles en acier inoxydable - Treteimer aus Edelstahl - Papeleras de acero inox - Ненужные ящики из нержавеющей стали



2809 lt.5
22,8 x 23,2 x 30 cm

13
Finitura lucida
Polished finishing



2309 lt.5
G·ARGENTA
20,5 x 24 x 30 cm

13
Finitura lucida
Polished finishing



2209 lt.3
G·ARGENTA
16,5 x 21,5 x 25 cm

13
Finitura lucida
Polished finishing



2909 lt.5
G·ARGENTA
14 x 29,4 x 30 cm

13
Finitura lucida
Polished finishing



2409 lt.7
G·ARGENTA
20,5 x 26,5 x 31,8 cm

13
Finitura lucida
Polished finishing



2709 lt.5
G·ARGENTA
20,5 x 26,5 x 27,8 cm

13
Finitura lucida
Polished finishing



2609 lt.3
G·ARGENTA
17 x 22,5 x 26 cm

13 **44**
Finitura lucida Bronzato
Polished finishing Bronze

Cestini in resine termoplastiche

Waste bins of thermoplastic resins - Poubelles en résines thermoplastiques - Treteimer aus Kunststoff - Papeleras de resinas termoplásticas - Ненужные ящики из термопластичной резины

G·MOBY

Design: Babled & Co.



3109 lt.4
23,2 x 29 x 27,3 cm

49 **89**
Bianco/Lilla
White/Lilac Bianco/Blu
White/Blue

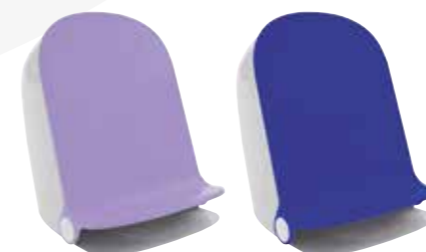

G•PENG

Design: Pedrizzetti e Associati

1009 lt. 7,5
22,9 x 23,8 x 34,5 cm

24

Bianco/Nero
White/Black



1109 lt. 4,5
G•MOSQUITO

Design: Babled & Co.

20,7 x 15,9 x 35,2 cm

02

Bianco
White



2009 lt. 10,8
G•BOXER

Design: Makio Hasuike

ø 22,5 x 31 cm

02

Bianco
White



8009 lt. 4,8
G•JUNIOR

Design: Olaf Von Bohr

21 x 15 x 34 cm

resine termoplastiche
thermoplastic resins

02

Bianco
White

04

Verde
Green

67

Arancio
Orange

79

Lilla
Lilac

propylux

P2

Bianco opalino
Mat white

P0

Rosa
Pink

P1

Azzurro
Light blue

P7

Acquamarina
Acquamarine



8609 lt. 6
G•VENEZIA

ø 23 x 24,5 cm

P2

Bianco opalino
Mat white



pag. 122



pag. 189



pag. 139

G•RAINBOW

RA09 It.6

18 x 18 x 23,7 cm



02 Bianco White	04 Verde Green	05 Blu Blue
06 Rosso Red	14 Nero Black	67 Arancio Orange
73 Argento Silver	76 Fucsia Fuchsia	79 Lilla Lilac

G•GLADY

GLO9 It.6,6

ø 21,1 x 25,4 cm



00 Trasparente Transparent	02 Bianco White	04 Verde acido Acid green
14 Nero Black	67 Arancio Orange	76 Fucsia Fuchsia
	79 Lilla Lilac	92 Turchese Turquoise



Scopini wc in metallo

Metal toilet brushes - Porte balais en métal - WC-Bürstengarnituren aus Metall
Porta escobillas en metal - Ёршик из металла

Acciaio
Steel - Acier - Stahl - Acero - Сталь



ATTACCARE A MURO

13
Finitura lucida
Polished finishing



2733 G·ASCOT

ø 8,5 x 38 cm



2733/O3 G·ASCOT

ø 8,5 x 9 x 38 cm

Wall brush holder
À mur
Wandbürstengarnitur
De pared
Настенный ёршик



5433 G·LOUNGE

8 x 8 x 40,4 cm

13
Cromato lucido
Chromed



2133 G·WINNY

Design: Piet Billekens

8,4 x 36 cm

Acciaio - Steel - Acier - Stahl - Acero - Сталь

02 13
Bianco laccato
Lacquered white

Finitura lucida
Polished finishing



NE33 G·NEMESIA

9 x 9 x 38 cm

13
Finitura lucida
Polished finishing



5433/O3 G·LOUNGE

8 x 11,2 x 40,4 cm

13
Cromato lucido
Chromed

Da muro - Wall brush holder - à mur
Wandbürstengarnitur - De pared
Настенный ёршик



2133/O3 G·WINNY

Design: Piet Billekens

9,2 x 34 cm

Acciaio - Steel - Acier - Stahl - Acero - Сталь

Da muro - Wall brush holder - à mur
Wandbürstengarnitur - De pared - Настенный ёршик

02 13
Bianco laccato
Lacquered white

Finitura lucida
Polished finishing



NE33/O3 G·NEMESIA

9 x 9 x 38 cm

13
Finitura lucida
Polished finishing

Da muro - Wall brush holder
à mur - Wandbürstengarnitur
De pared - Настенный ёршик



ED34 G·EDERA

ø 7,5 x 40 cm

02 13
Bianco laccato
Lacquered white

Finitura lucida
Polished finishing



ED34/O3 G·EDERA

ø 7,5 x 7,8 x 40 cm

02 13
Bianco laccato
Lacquered white

Finitura lucida
Polished finishing

Da muro - Wall brush holder
à mur - Wandbürstengarnitur
De pared - Настенный ёршик

Acciaio inox - Stainless steel
 Acier inoxydable - Edelstahl
 Acero inox - Нержавеющая сталь



3833 G·KANSAS

8,7 x 8,7 x 36 cm

13

Finitura lucida
 Polished finishing



3733 G·TEXAS

11,5 x 9,5 x 41 cm

13

Cromato lucido
 Chromed



5733 G·GLAMOUR

10 x 10 x 39 cm

02

Bianco
 White



5733/O3 G·GLAMOUR

10 x 13 x 39 cm

13

Cromato lucido
 Chromed

Da muro - Wall brush holder - à mur
 Wandbürstengarnitur - De pared
 Настенный ёршик



FE33 G·FELCE

ø 7,8 x 33,4 cm

13

Finitura lucida
 Polished finishing

Acciaio - Steel - Acier - Stahl - Acero - Сталь



7533 G·ROMANCE

ø 9 x 41 cm

44

Bronzo
 Bronze

Cromall®



5533 G·KENT

9,7 x 9 x 36,2 cm

13

Cromato lucido
 Chromed

Cromall®



PI33/O3 G·PIRENEI

8,5 x 10,9 x 36,5 cm

13

Cromato lucido
 Chromed

Da muro - Wall brush holder - à mur
 Wandbürstengarnitur - De pared
 Настенный ёршик



DS33 G·DIASPRO

ø 10 x 38,5 cm

13

Cromato lucido
 Chromed



PR33 G·PRIMULA

ø 10 x 38 cm

21

Finitura
 lucida/spazzolata
 Polished/
 brushed finishing



CO34 G·ORIENTE

ø 9,5 x 37 cm

13

Finitura lucida
 Polished finishing



6633 G·MINNESOTA

10,2 x 10,2 x 37,5 cm

02

Bianco
 White



6533 G·NAXOS

ø 10,2 x 37,5 cm

02

Bianco
 White

Scopini wc in ceramica

Pottery toilet brushes - Porte balais en céramique - WC-Bürstengarnituren aus Keramik
 Porta escobillas en cerámica - Ёршик из керамики

Scopini w/c in resine termoplastiche

Thermoplastic resins toilet brushes - Porte balais en thermoplastique - WC-Bürstengarnituren aus Kunststoff
Porta escobillas en resinas termoplásticas - Ёршик, изготовлено из термопластичных смол



7033 G-WENDY

Design: Babled & Co.

ø 16,7 x 45 cm

02 89

Bianco/
Bianco
White/
White

Bianco/
Blu
White/Blue



pag. 74

6133 G-SEVENTY

Design: Matteo Thun

02

Bianco
White



11,5 x 11,5 x 34 cm

2033 G-CUCCILO

Design: Makio Hasuike

ø 15 x 33,5 cm

02

Bianco
White

Ciuffo in PVC o setole
PVC brush or bristle brush



Inserito nella
collezione permanente
del MOMA di New York
In the permanent
collection of
the MOMA in New York

2633 G-PIPPO

Design: Makio Hasuike

ø 14 x 43,5 cm

02

Bianco
White

Ciuffo in PVC
PVC brush



95





8833 G·OSCAR

Design: Matteo Thun

ø 13 x 35 cm

02	P0	P1	P2	P7
Bianco White	Rosa Pink	Azzurro Light blue	Bianco opalino Opaline white	Acquamarina Aquamarine



8533/03 G·OSCAR

Design: Matteo Thun

11 x 15 x 35 cm

Da muro - Wall brush holder - à mur
Wandbürstengarnitur - De pared
Настенный ёршик

02
Bianco White



Fissaggio con BIADESIVO o VITI
To be fixed with double-sided sticky
tape or screws
Fixation avec adhésif double face ou vis
Befestigung mit doppelseitigem
Klebeband oder Schrauben
Fijación con biadhesivo o tornillos
Крепление при помощи двухсторонней
адгезивной ленты или шурупов

G·ZENITH

Design: Hanno Giesler

1033

12 x 13 x 34,3 cm

02	76	79
Bianco White	Fucsia Fuchsia	Lilla Lilac
P1	P4	P8
Blu Blue	Arancio Orange	Verde acido Acid green



8034 G·JUNIOR

Design: Gianpietro Tonetti

ø 12,5 x 33 cm

02	04	67	79
Bianco White	Verde acido Acid green	Arancio Orange	Lilla Lilac



TO33 G·TOYO

13 x 13 x 38 cm

02
Bianco White



8033 G·JUNIOR

Design: R. & S. Prodotto Gedy

ø 13,5 x 39 cm

02	P0	P1
Bianco White	Rosa Pink	Azzurro Light blue
P2	P7	
Bianco opalino Opaline white	Acquamarina Aquamarine	

95



Sedili WC

Toilet seats - Abattants - WC-Sitze - Asientos wc - Туалетное сидение

G•SMERALDO

Realizzato in MDF con laccatura epossidica e cerniere in ottone cromato

Made of epoxy lacquered M.D. with chromed brass hinges

Réalisé en M.D. avec laquage époxy et fixations en laiton chromé

Hergestellt aus epoxy-lackiertem M.D. mit Befestigungen aus verchromtem Messing

Realizado en DM pintado epoxy y bisagras de latón cromado

Туалетное сидение изготовлено из Мд с покрытый зпоксдным лаком и хромированные латунные петли

02

Bianco
White

4007

37,8 x 47 x 4 cm.



10,5/20,1



G•CORNIOLA

Realizzato in MDF con laccatura epossidica e cerniere in Cromall®

Made of epoxy lacquered M.D. with Cromall® hinges

Réalisé en M.D. avec laquage époxy et fixations en Cromall®

Hergestellt aus epoxy-lackiertem M.D. mit Befestigungen aus Cromall®

Realizado en DM pintado epoxy y bisagras de Cromall®

Туалетное сиденье изготовленное из покрытого эпоксидным лаком Мд с петль из Cromall®

02

Bianco
White

4026

37 x 47 x 7 cm



15

G•AGATA

Realizzato in MDF con laccatura epossidica e cerniere in polipropilene

Made of epoxy lacquered wood with polypropylene hinges

Réalisé en M.D. avec laquage époxy et fixations en polypropylène

Hergestellt aus epoxy-lackiertem M.D. mit Polypropylenbefestigungen

Realizado en DM pintado epoxy con bisagras de polipropileno

Туалетное сиденье изготовленное из Мд покрытый эпоксидным лаком и полипропиленовых петль

02

Bianco
White

4025

37,5 x 47 x 5,5 cm



15

G • GRANATO

Realizzato in MDF con laccatura epossidica e stampa in 3D, dotato di cerniere in ottone cromato
 Made of epoxy lacquered M.D with 3D print and chromed brass hinges
 Réalisée en M.D. avec laquage epoxy et impression en 3D, fixations en laiton chromé
 Hergestellt aus Epoxi-lackiertem M.D mit 3D-Druck Befestigungen aus verchromtem Messing
 Realizado en M.D. envernizado epoxy e con decor 3D, bisagras de latón cromado
 Изготовлено из покрытого эпоксидным лаком M.D. с 3D достоинством и нейлоновые из нержавеющей стали

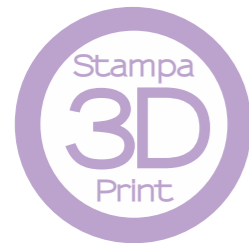

CO41
37,5 x 45 x 5,5 cm



10,5/20,5



02
Tigre



04
Rana



05
Tartaruga



06
Pesce
pagliaccio



63
Fiori



86
Pinguino



89
Pallone



92
Caraibi

G • ONICE

Realizzato in MDF con laccatura epossidica e decoro metallico, dotato di cerniere in ottone cromato
 Made of epoxy lacquered M.D with decorative metal plate, chromed brass hinges
 Réalisée en M.D. avec laquage epoxy et plaque de métal, fixations en laiton chromé
 Hergestellt aus Epoxi-lackiertem M.D mit Metallplatte, Befestigungen aus verchromtem Messing
 Realizado en M.D. pintado epoxy con placa metálica, bisagras de latón cromado
 Изготовлено из покрытого эпоксидным лаком M.D с металлической пластиной и нейлоновые из нержавеющей стали



CO42
37,5 x 44,5 x 6 cm



10,4/20,8



02
Open



06
Gas

Realizzato in resina poliestere con cerniere in ottone cromato

Made of resin with chromed brass hinges

Réalisé en résine avec fixations en laiton chromé

Hergestellt aus Harz mit Befestigungen aus verchromtem Messing

Realizado en resina de poliestere con bisagras de latón cromado

Изготовлено из смолы - хромированные латунные петли

89

Grecia

CO40

36 x 44 x 5 cm



Sedile WC per sanitari modello Conca
Toilet seat for Conca sanitary fixtures

Abattant pour sanitaires modèle Conca

WC-Sitz für Modell Conca

Asiento WC para sanitarios modelo Conca

Сидение для унитаза модели Conca

4022

34 x 5 x 46 cm

02

Bianco
White



G • YELLOWSTONE

Realizzato in legno con cerniere in ottone cromato

Made of wood with brass hinges

Réalisé en bois avec fixations en laiton

Hergestellt aus Holz mit Befestigungen aus Messing

Realizado en madera con bisagras de latón

Изготовлено из дерева с хромированные латунные петли

30

Noce
Walnut colour

8151

35,5 x 43 x 4 cm



Sedile WC per sanitari modello Tesi
Toilet seat for Tesi sanitary fixtures

Abattant pour sanitaires modèle Tesi

WC-Sitz für Modell Tesi

Asiento WC para sanitarios modelo Tesi

Сидение для унитаза модели Tesi

4023

34,8 x 6 x 42,5 cm

02

Bianco
White



Realizzato in MDF con laccatura epossidica e cerniere in ottone cromato
 Made of epoxy lacquered M.D with chromed brass hinges
 Réalisée en M.D. avec laquage époxy et fixations en laiton chromé
 Hergestellt aus Epoxi-lackiertem M.D mit Befestigungen aus verchromtem Messing
 Realizado en M.D. envernizado epoxi con bisagras de latón cromado
 Изготовлено из покрытого эпоксидным лаком M.D., нейлоновые из нержавеющей стали



02
 Bianco
 White

4014

34,9 x 46,5 x 5,9 cm

Sedile WC per sanitari modello Ellisse
 Toilet seat for Ellisse sanitary fixtures
 Abattant pour sanitaires modèle Ellisse
 WC-Sitz für Modell Ellisse
 Asiento WC para sanitarios modelo Ellisse
 Сидение для унитаза модели Ellisse



11,9/17,5

Realizzato in MDF con laccatura epossidica e cerniere in ottone cromato
 Made of wooden seat with epoxy lacquer and chromed brass hinges
 Réalisée en bois avec laquage époxy et fixations en laiton chromé
 Hergestellt aus Holz mit Epoxy-Lackierung und Befestigungen aus verchromtem Messing
 Realizado en madera con lacado epoxídico y con bisagras de latón cromado
 Изготовлено из аервянного, покрытого эпоксидного краского для сантехники, нейлоновые из нержавеющей стали



02
 Bianco
 White

4024

36 x 47 x 5,5 cm

Sedile WC per sanitari modello Aretusa
 Toilet seat for Aretusa sanitary fixtures
 Abattant pour sanitaires modèle Aretusa
 WC-Sitz für Modell Aretusa
 Asiento WC para sanitarios modelo Aretusa
 Сидение для унитаза модели Aretusa



10,7/20,7

Realizzato in MDF con laccatura epossidica e cerniere in ottone cromato
 Made of epoxy lacquered M.D with chromed brass hinges
 Réalisée en M.D. avec laquage époxy et fixations en laiton chromé
 Hergestellt aus Epoxi-lackiertem M.D mit Befestigungen aus verchromtem Messing
 Realizado en M.D. envernizado epoxi con bisagras de latón cromado
 Изготовлено из покрытого эпоксидным лаком M.D., нейлоновые из нержавеющей стали



02
 Bianco
 White

4027

35 x 48 x 5,8 cm

Sedile WC per sanitari modello Sintesi
 Toilet seat for Sintesi sanitary fixtures
 Abattant pour sanitaires modèle Sintesi
 WC-Sitz für Modell Sintesi
 Asiento WC para sanitarios modelo Sintesi
 Сидение для унитаза модели Sintesi



Realizzato in MDF con laccatura epossidica e cerniere in ottone cromato
 Made of epoxy lacquered M.D with chromed brass hinges
 Réalisée en M.D. avec laquage époxy et fixations en laiton chromé
 Hergestellt aus Epoxi-lackiertem M.D mit Befestigungen aus verchromtem Messing
 Realizado en M.D. envernizado epoxi con bisagras de latón cromado
 Изготовлено из покрытого эпоксидным лаком M.D., нейлоновые из нержавеющей стали



02
 Bianco
 White

4028

36 x 41,5 x 6 cm

Sedile WC per sanitari modello Victoria
 Toilet seat for Victoria sanitary fixtures
 Abattant pour sanitaires modèle Victoria
 WC-Sitz für Modell Victoria
 Asiento WC para sanitarios modelo Victoria
 Сидение для унитаза модели Victoria





Realizzato in MDF con laccatura epossidica e cerniere in ottone cromato

Made of epoxy lacquered M.D with chromed brass hinges

Réalisée en M.D. avec laquage époxy et fixations en laiton chromé

Hergestellt aus Epoxi-lackiertem M.D mit Befestigungen aus verchromtem Messing

Realizado en M.D. envernizado epoxi con bisagras de latón cromado

Изготовлено из покрытого эпоксидным лаком M.D., нейлоновые из нержавеющей стали



Bianco White

4030

34,4 x 44,7 x 6 cm

Sedile WC per sanitari modello System
Toilet seat for System sanitary fixtures
Abattant pour sanitaires modèle System
WC-Sitz für Modell System
Asiento WC para sanitarios modelo System
Сидение для унитаза модели System



11,8/17,4

Realizzato in MDF con laccatura epossidica e cerniere in ottone cromato

Made of wooden seat with epoxy lacquer and chromed brass hinges

Réalisée en bois avec laquage époxy et fixations en laiton chromé

Hergestellt aus Holz mit Epoxy-Lackierung und Befestigungen aus verchromtem Messing

Realizado en madera con lacado epoxídico y con bisagras de latón cromado

Изготовлено из аервянного, покрытого эпоксидного краского для сантехники, нейлоновые из нержавеющей стали



Bianco White

4009

36,5 x 45,5 x 6 cm

Sedile WC per sanitari modello disabili
Toilet seat for disabled model bathroom fittings
Abattant pour sanitaires modèle porteurs de handicap
WC-Sitz für für sanitäre Einrichtungen Modell Behinderte
Asiento WC para instalaciones sanitarias modelo minusválidos
Сидение для унитаза модели для инвалидов



10/20

Realizzato in MDF con laccatura epossidica e cerniere in ottone cromato

Made of wooden seat with epoxy lacquer and chromed brass hinges

Réalisée en bois avec laquage époxy et fixations en laiton chromé

Hergestellt aus Holz mit Epoxy-Lackierung und Befestigungen aus verchromtem Messing

Realizado en madera con lacado epoxídico y con bisagras de latón cromado

Изготовлено из аервянного, покрытого эпоксидного краского для сантехники, нейлоновые из нержавеющей стали



Bianco White

4005

37,8 x 46,5 x 6 cm

Sedile WC per sanitari modello disabili
Toilet seat for disabled model bathroom fittings
Abattant pour sanitaires modèle porteurs de handicap
WC-Sitz für für sanitäre Einrichtungen Modell Behinderte
Asiento WC para instalaciones sanitarias modelo minusválidos
Сидение для унитаза модели для инвалидов



9,8/19,7



4001

37,8 x 45,7 x 5 cm - kg. 1900

Realizzato in resine termoindurenti con cerniere in acciaio inox

Made of thermosetting resins, hinges of stainless steel

Réalisée en thermodurcissable, fixations en acier inoxydable

Hergestellt aus Duroplast, Befestigungen aus Edelstahl

Realizado en resina termoestable con bisagras de acero inoxidable

Изготовлено из териореактивных пластмасс с нейлоновые из нержавеющей стали



Bianco White



6,5/16,5



G•QUARTZ

Realizzato in resine termoindurenti, dotato di cerniere in resine termoplastiche
 Made of thermosetting resins with adjustable plastic hinges
 Réalisé en thermodurcissable avec fixations réglables en thermoplastique
 Hergestellt aus Duroplast mit Befestigungen aus Kunststoff
 Realizado en resina termoestable con bisagras de termoplástica
 Изготовлено из терioreактивных пластмасс с нейлоновые петли

4002

36,5 x 43 x 4 cm - 2,145 kg.



G•ZIRCONE

Realizzato in resine termoindurenti con cerniere in acciaio inox
 Made of thermosetting resins, hinges of stainless steel
 Réalisée en thermodurcissable, fixations en acier inoxydable
 Hergestellt aus Duroplast, Befestigungen aus Edelstahl
 Realizado en resina termoestable con bisagras de acero inoxidable
 Изготовлено из терioreактивных пластмасс с нейлоновые из нержавеющей стали

4003

37,2 x 46 x 5 cm - 1700 kg.



G•DIAMANTE

Realizzato in resine termoindurenti, dotato di cerniere in resine termoplastiche
 Made of thermosetting resins with adjustable plastic hinges
 Réalisé en thermodurcissable avec fixations réglables en thermoplastique
 Hergestellt aus Duroplast mit Befestigungen aus Kunststoff
 Realizado en resina termoestable con bisagras de termoplástica
 Изготовлено из терioreактивных пластмасс. Нейлоновые петли

4017

44,2 x 43,5/45 x 4 cm - 1,760 kg.



02
 Bianco
 White

G•AMBRA

Realizzato in resine termoplastiche con cerniere in politene
 Made of thermoplastic resins with polythene hinges
 Réalisé en thermoplastique avec fixations en polythène
 Hergestellt aus Kunststoff mit Polytenbefestigungen
 Realizado en resinas termoplásticas con bisagras de polytene
 Изготовлено из термопластичных смол. Полипропиленовые петли

4008

37,5 x 46,5 x 5,5 cm - 0,589 kg.



02
 Bianco
 White

OPALINI - OPALINES
 P1 P7
 Azzurro Acquamarina
 Light blue Aquamarine

G•OSCAR

Realizzato in resine termoplastiche con cerniere in polipropilene

Made of thermoplastic resin with polypropylene hinges

Réalisé en thermoplastique avec fixations en polypropylène

Hergestellt aus Kunststoff mit Polypropylenbefestigungen

Realizado en resinas termoplásticas con bisagras de polipropileno

Изготовлено из термопластичных смол. Полипропиленовые петли

OPALINI - OPALINES

02

Bianco
White

P0

Rosa
Pink

P1

Azzurro
Light blue

P2

Bianco
White

P7

Acquamarina
Aquamarine

76

Fucsia
Fuchsia

79

Lilla
Lilac

4019

37 x 45,5 x 5,5 cm - 0,756 kg.





MULTIFUNCTION

MULTIFUNCTION

Porta asciugacapelli

Hairdryer supports
Supports sèche-cheveux
Haartrocknerhalter
Soportes para secador de pelo
Держатель для фена



5055

10,6 x 16 x 17,2 cm

Cromall® e acciaio cromato
Cromall® and chromed steel
Cromall® et acier chromé
Cromall® und verchromter Stahl
Cromall® y acero cromado
Cromall® и хромированная сталь

13
Cromato
lucido
Chromed



13
Cromato
lucido
Chromed



Con fissaggio a VENTOSA
With suction cup fixing
Fixation avec ventouse
Mit Saugnapf aufhängbar
Fijación con ventosa
с присосом

HO52 G•HOT

10,7 x 12 x 22 cm

Metallo e resine termoplastiche
Metal and thermoplastic resins
Métal et thermoplastique
Metall und Kunststoff
Metal y resinas termoplásticas
Металл и термопластичные смолы



Fissaggio ad INCOLLO
Fixes into place with adhesive
Fixation par encollage
Befestigung mit Klebstoff
Fijación por medio de pegado
Крепление клеем



Fissaggio con VITI
Fixes into place with screws
Fixation par vis
Befestigung mit Schrauben
Fijación con tornillos
Крепление шурупами



5056

10,6 x 16,3 x 8,2 cm

Cromall® e acciaio cromato
Cromall® and chromed steel
Cromall® et acier chromé
Cromall® und verchromter Stahl
Cromall® y acero cromado
Cromall® и хромированная сталь

13
Cromato
lucido
Chromed

02
Bianco
White

5052/301

9,5 x 10,2 x 11,2 cm

Resine termoplastiche
Thermoplastic resins
Thermoplastique
Kunststoff
Resinas termoplásticas
Термопластичные смолы



Appendiabiti

Hooks - Crochets - Haken - Perchas - Крючок



2123

40 x 7,2 x 12,2 cm

2124

40 x 5,4 x 13,6 cm

Acciaio inox

Stainless steel
Acier inoxydable
Edelstahl
Acero inox
Нержавеющей сталь

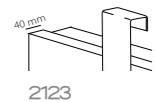

2123

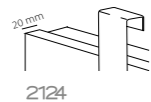

2124

13

Finitura lucida
Polished finishing

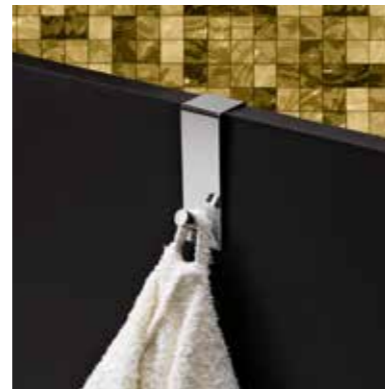

2125

4,5 x 7,5 x 14 cm

Acciaio inox

Stainless steel
Acier inoxydable
Edelstahl
Acero inox
Нержавеющей сталь

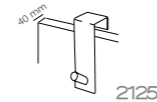

2125

13

Finitura lucida
Polished finishing



2126

3 x 4,6 x 11 cm

Acciaio inox

Stainless steel
Acier inoxydable
Edelstahl
Acero inox
Нержавеющей сталь

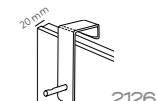

2126

13

Finitura lucida
Polished finishing



HO26 G·HOT

6,3x 4,5 x 10,8 cm

**Metallo/
resine termoplastiche**

Metal/thermoplastic resins
Métal/thermoplastique
Metall/Kunststoff
Metal/resinas termoplásticas
Металл/термопластичных смол



Con fissaggio a VENTOSA
With suction cup fixing
Fixation avec ventouse
Mit Saugnapf aufhängbar
Fijación con ventosa
с присосом

13

Cromato lucido
Chromed



5 kg



RA26 G·RAINBOW

8 x 3,1 x 4 cm

Design: R. & S. Prodotto Gedy

Realizzati in resine termoplastiche

Made of thermoplastic resins - Réalisés en thermoplastique
Hergestellt aus Kunststoff - Realizados en resinas termoplásticas
Изготовлено из термопластичных смол

02

Bianco
White

73

Argento
Silver

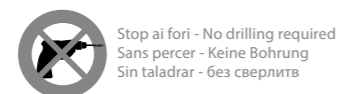

Stop ai fori - No drilling required
Sans percer - Keine Bohrung
Sin taladrar - без сверлить

3 kg



Fissaggio con biadesivo
Adhesive fixing

Appendiabiti per termoarredi

Hanging hook for designer radiators - Crochet pour radiateurs décoratifs
Kleiderhaken für Heizkörper - Gancho para toalleros calentadores de decoración
Вешалка для термоустановок

G·MERLINO

Realizzato in resine termoplastiche
Made of thermoplastic resins - Réalisé en thermoplastique
Hergestellt aus Kunststoff - Realizado en resinas termoplásticas
Изготовлено из термопластичных смол



00 Trasparente Transparent	02 Bianco White	13 Cromato Chromed
14 Nero Black	P0 Fucsia trasparente Transparent fuchsia	P1 Azzurro trasparente Transparent light blue
P4 Arancio trasparente Transparent orange	P8 Verde trasparente Transparent green	P9 Lilla trasparente Transparent lilac



2025

3,2 x 6,7 x 11,7 cm

Sgabelli

Stools - Tabourets - Hocker - Taburetes - Табурет

02

Bianco
White

23

Bianco/
cromo
White/
chromed

43

Antracite/
cromo
Anthracite/
chromed

6072

40,9 x 33,1 x 43,8 cm

Sgabello - alluminio/ABS

Stool - aluminium/ABS
Tabouret - aluminium/ABS
Hocker - Aluminium/ABS
Taburete - aluminio/ABS
Табурет - алюминий/ABS

Design: Studio Talocci



ø 25 - sp.1



160
kg



02

Bianco
White

2872 G•TETRA

Design: Olaf Von Bohr

42 x 27 x 41 cm

Resine termoplastiche

Thermoplastic resins
Thermoplastique
Kunststoff
Resinas termoplásticas
Термопластичные смолы



100
kg



02

Bianco
White

2073 G•BOX

Design: Olaf Von Bohr

38,5 x 32,5 x 40,3 cm

Resine termoplastiche

Thermoplastic resins
Thermoplastique
Kunststoff
Resinas termoplásticas
Термопластичные смолы



80
kg



02

Bianco
White

04

Verde
Green

67

Arancio
Orange

2072 G•TRIO

Design: Olaf Von Bohr

ø 33 x 40 cm

Resine termoplastiche

Thermoplastic resins
Thermoplastique
Kunststoff
Resinas termoplásticas
Термопластичные смолы



100
kg



Sgabello e cesto svuota lavatrice

Stool and laundry bin - Tabourets et coffre à linge - Hocker und Wäschebehälter
Taburetes y cesta para ropa - Табурет и корзина для белья

G•WENDY

Design: Babled & Co.

Realizzato in resine termoplastiche
Made of thermoplastic resins - Réalisé en thermoplastique
Hergestellt aus Kunststoff - Realizado en resinas termoplásticas
Изготовлено из термопластичных смол

02 Bianco/ Grigio White/ Grey	49 Bianco/ Lilla White/ Lilac	60 Bianco/ Verde White/ Green
89 Bianco/ Blu White/ Blue	93 Bianco/ Arancio White/ Arancio	



7073
35,6 x 32,6 x 38,9 cm 

inserire una foto
più esplicitiva



Sgabelli richiudibili

Foldable stools - Tabourets repliable - Klapphocker
Taburetes plegable - Выдвигающиеся табуретки

98
Pero
Pear wood

CO73
ø 29,8 x 46 cm

Realizzato in MDF e metallo
Made of MDF and steel
Réalisé en MDF et métal
Hergestellt aus MDF und Metall
Realizado en DM y metal
Изготовлено из MDF и металла



02 Bianco White	05 Blu Blue	67 Arancio Arancio
76 Fucsia Fuchsia	79 Lilla Lilac	

CO75
30 x 29,3 x 46,5 cm

Realizzato in resine termoplastiche e metallo
Made of thermoplastic resins and steel
Réalisé en thermoplastique et métal
Hergestellt aus Kunststoff und Metall
Realizado en resinas termoplásticas y metal
Изготовлено из термопластичных смол и металла



Cesti portabiancheria e scatole

Laundry baskets and boxes - Panier à linge et boîtes - Wäschebehälter und Boxen
Cestas contenedoras para ropa sucia y cajas - Корзина для грязного белья и коробки

G • LAVANDA

Realizzati in raffia e nylon
Made of raffia and nylon - Réalisés en raphia et nylon - Hergestellt aus Past und Nylon
Realizados en raffia y nylon - Изготовлено из рафии и нейлона



08
Grigio
Grey

29
Moka



LA38

35 x 35 x 58 cm

Cesto portabiancheria
Laundry basket - Panier à linge - Wäschekorb
Cesto ropa sucia - Корзина для грязного белья

Scatole
Boxes - Boîtes - Schachteln - Cajas - Корбки



LA99

2 da cm. 11x10x7,5
1 da cm. 13,5x24x8
1 da cm. 15,5x25,5x9

LA06

31 x 19 x 16,5 cm

LA07

21 x 15 x 12 cm



Sacchetto interno estraibile e lavabile per la massima igiene
Fully removable and washable sack inside for maximum hygiene
Sachet intérieur extractible et lavable pour le maximum d'hygiène
Wäschebeutel, Innenteil abnehmbar und waschbar für maximale Hygiene
Bolsita interna extraíble y lavable para la máxima higiene
В целях гигиены внутренний пакет можно извлечь и помыть

95
Noce
anticato
Old walnut
colour

8138 G • MONTANA

36,3 x 31,2 x 49,5 cm

Realizzato in legno, MDF e tessuto
Made of wood, MDF and fabric
Réalisé en bois, MDF et tissu
Hergestellt aus Holz, MDF und Stoff
Realizado en madera, DM y tejido
Изготовлено из дерева, МДФ и клеёнки

100
kg



19
Wengé

2239 G • VITO

51 x 29 x 57 cm

Realizzato in faggio, bambù e tessuto teflonato
Made of beech, bamboo and teflon flax fabric coating
Réalisé en hêtre, bambou et tissu téfloné
Hergestellt aus Buche, Bambus und teflonbeschichtetem Stoff
Hecho de haya, bambú y tejido teflonado
Изготовлено из бука, бамбука с покрытием из клеёнки



Sacchetto interno estraibile e lavabile per la massima igiene
Fully removable and washable sack inside for maximum hygiene
Sachet intérieur extractible et lavable pour le maximum d'hygiène
Wäschebeutel, Innenteil abnehmbar und waschbar für maximale Hygiene
Bolsita interna extraíble y lavable para la máxima higiene
В целях гигиены внутренний пакет можно извлечь и помыть

Con cerniere in metallo
Metal hinges - Glissières en métal
Metallscharniere - Cremalleras de metal
Шарниры металлические

G•AMBROGIO

Realizzato in resine termoplastiche
 Made of thermoplastic resins - Réalisé en thermoplastique
 Hergestellt aus Kunststoff - Realizado en resinas termoplásticas
 Изготовлено из термопластичных смол



- 02
 Bianco
 White
- 03
 Beige
- 05
 Blu
 Blue



2038
 50 x 28 x 55 cm

- 03
 Ecrú

BU38 G•BUBO

43 x 46 x 64,5 cm

Realizzato in tessuto (cotone 35%,
 poliestere 65%) e legno
 Made of fabric (cotton 35%, polyester 65%) and wood
 Réalisé en tissu (coton 35%, polyester 65%) et bois
 Hergestellt aus Stoff (Baumwolle 35%, Polyester 65%) und Holz
 Realizado en tejido (algodón 35%, poliéster 65%) y madera
 Изготовлено из ткани (хлопка 35%, полиэстер 65%) и дерева



- 03
 Ecrú
- 07
 Verde
 Green
- 11
 Azzurro
 Light blue

CO38 G•LAUNDRY

ø 38 x 58 cm

Realizzato in tessuto (cotone 35%,
 poliestere 65%) e metallo
 Made of fabric (cotton 35%, polyester 65%) and steel
 Réalisé en tissu (coton 35%, polyester 65%) et métal
 Hergestellt aus Stoff (Baumwolle 35%, Polyester 65%) und Metall
 Realizado en tejido (algodón 35%, poliéster 65%) y metal
 Изготовлено из ткани (хлопка 35%, полиэстер 65%) и металла



Complementi

Decorative accessories - Accessoires complémentaires - Zusätzliche Zubehör
Complementos - Декоративные аксессуары

G•SPOT

00
Satinato
Satinized

G•ARTEMIS

Mensole
Shelves - Étagères - Ablagen
Estantes - Полочки

Realizzate in vetro Ultralight 6 mm e Cromall®
Made of 6 mm Ultralight glass and Cromall®
Réalisés en verre Ultralight 6 mm et Cromall®
Hergestellt aus 6 mm Ultralight Glas und Cromall®
Realizados en cristal Ultralight 6 mm y Cromall®
Изготовлено из стекла Ultralight 6 mm и Cromall®



Realizzato in PVC
Made of PVC - Réalisé en PVC - Hergestellt aus PVC
Realizado en PVC - Изготовлено из PVC



P0 Fucsia Fuxia
P1 Azzurro Light blue
P2 Trasparente Transparent
P4 Arancio Orange
P8 Verde acido Acid green
P9 Lilla Lilac



2004

12,7 x 8,7 x 1,6 cm

Portasapone

Soap holder - Porte savon - Seifenschale
Jabonera - Мыльница

Piantane

Towel stands - Ensembles sur pied - Ständer - Columnas
Стойка для полотенец для ванной комнаты

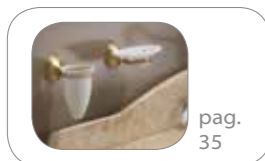

G • ROMANCE

Realizzate in acciaio e Cromall® con contenitori in vetro satinato
Made of steel and Cromall® with satinized glass containers
Réalisées en acier et Cromall® avec pièces en verre satiné
Hergestellt aus Stahl und Cromall® mit Behältern aus satiniertem Glas
Realizados en acero y Cromall® con contenedores en cristal satinado
Изготовлено из стали и Cromall® с ёмкостями из матового стекла

44

Bronzato
Bronze



7531

ø 25,4 x 42,7 x 95 cm

7532

ø 25,4 x 80 cm

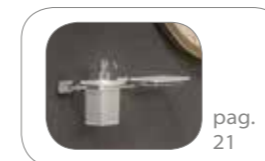

G • MINNESOTA

Design: R. & S. Prodotto Gedy

Realizzate in acciaio inox, Cromall® e ABS con contenitori in ceramica
Made of stainless steel, Cromall® and ABS with mat containers
Réalisés en acier inoxydable, Cromall® et ABS avec pièces en céramique
Hergestellt aus Edelstahl, Cromall® und ABS mit Behältern aus Keramik
Realizadas en acero inox, Cromall® y ABS con contenedores en cerámica
Изготовлено из стали, Cromall® и ABS с ёмкостями из керамики

13

Cromato lucido
Chromed



6631

16 x 36,1 x 90 cm

6632

19,4 x 22 x 62 cm

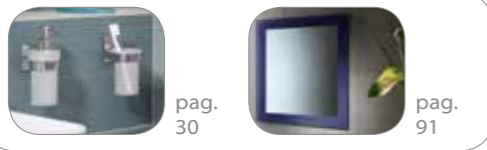

pag. 30

pag. 91

G·MAINE

Design: R. & S. Prodotto Gedy

Realizzate in acciaio inox, Cromall® e resine termoplastiche
 Made of stainless steel, Cromall® and thermoplastic resins
 Réalisés en acier inoxydable, Cromall® et thermoplastique
 Hergestellt aus Edelstahl, Cromall® und Kunststoff
 Realizadas en acero inox, Cromall® y resinas termoplásticas
 Изготовлено из нержавеющей стали, Cromall® и термопластичных смол



13

Cromato
Chromed

7831

39 x 16 x 89 cm

78311300

senza copribase - without base cover

7832

25 x 16 x 70 cm

78321300

senza copribase - without base cover



7831..50

24 x 15,5 x 0,9 cm

Copribase per 7831

base cover for 7831 - couverture pour 7831
 Rosette für 7831 - embellecedor para 7831
 Нижняя крышка для 7831



7832..50

24 x 15,5 x 0,9 cm

Copribase per 7832

base cover for 7832 - couverture pour 7832
 Rosette für 7832 - embellecedor para 7832
 Нижняя крышка для 7831

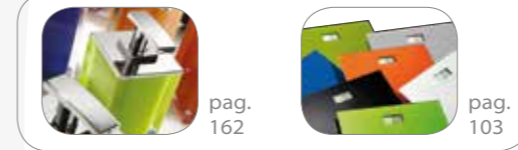

pag. 162

pag. 103

G·RAINBOW

Realizzate in acciaio inox e resine termoplastiche
 Made of stainless steel and thermoplastic resins
 Réalisés en acier inoxydable et thermoplastique
 Hergestellt aus Edelstahl und Kunststoff
 Realizadas en acero inox y resinas termoplásticas
 Изготовлено из нержавеющей стали и термопластичных смол



RA31

40,4 x 15,5 x 83,7 cm

RA32

25,7 x 16 x 58,8 cm

G·VIRGINIA

Design: R. & S. Prodotto Gedy

Realizzate in acciaio inox e resine termoplastiche

Made of stainless steel and thermoplastic resins

Réalisés en acier inoxydable et thermoplastique

Hergestellt aus Edelstahl und Kunststoff

Realizadas en acero inox y resinas termoplásticas

Изготовлено из нержавеющей стали и термопластичных смол



13

Cromato
Chromed

2131

ø 21 x 42 x 88 cm

2132

ø 21 x 26 x 61 cm



13

Cromato
Chromed

2731

ø 25 x 43,5 x 93,7 cm

2732

ø 25 x 25,5 x 78,5 cm

G·TRACY

Design: R. & S. Prodotto Gedy

Realizzate in acciaio e vetro

Made of steel and glass

Réalisés en acier et verre

Hergestellt aus Stahl und Glas

Realizadas en acero y cristal

Изготовлено из металла и стекла

G•WINNY

Design: Piet Billekens

Realizzate in acciaio
Made of steel
Réalisés en acier
Hergestellt aus Stahl
Realizados en acero
Изготовлено из металла

02

13

Bianco laccato Cromato
Lacquered white Chromed

rivedere le foto
cromate



2831

ø 25 x 43,6 x 89 cm

2832

ø 25 x 29 x 67 cm

G•HIBISCUS

Realizzate in acciaio e resine termoplastiche
Made of steel and thermoplastic resins
Réalisés en acier et thermoplastique
Hergestellt aus Stahl und Kunststoff
Realizados en acero y resinas termoplásticas
Изготовлено из металла и термопластических смол

13

Cromato
Chromed



HI31

36,5 x 30 x 90,5 cm

HI32

29,6 x 18 x 75 cm

G·MAMMOLO

Design: R. & S. Prodotto Gedy

Realizzate in acciaio inox e resine termoplastiche
 Made of stainless steel and thermoplastic resins
 Réalisés en acier inoxydable et thermoplastique
 Hergestellt aus Edelstahl und Kunststoff
 Realizadas en acero inox y resinas termoplásticas
 Изготовлено из нержавеющей стали и термопластичных смол

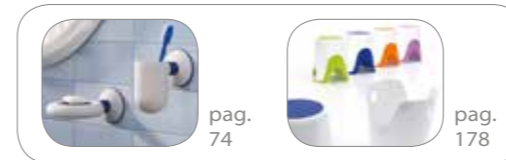

G·WENDY

Design: Babled & Co

Realizzate in resine termoplastiche
 Made of thermoplastic resins
 Réalisés en thermoplastique
 Hergestellt aus Kunststoff
 Realizadas en resinas termoplásticas
 Изготовлено из термопластичных смол

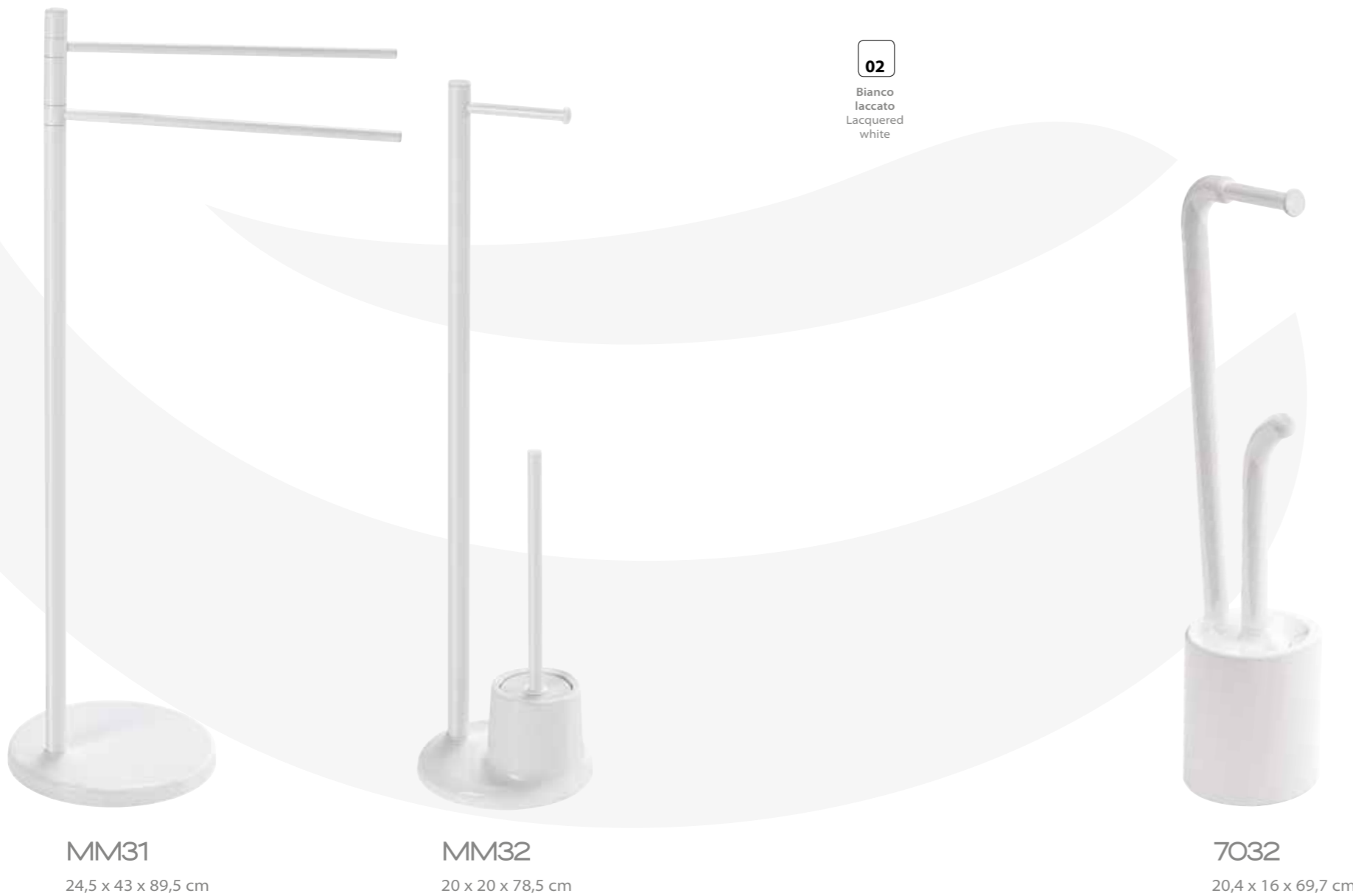

MM31

24,5 x 43 x 89,5 cm

MM32

20 x 20 x 78,5 cm

7032

20,4 x 16 x 69,7 cm

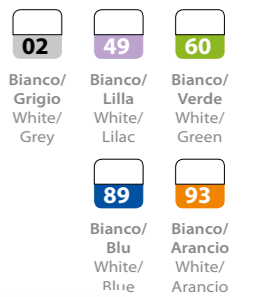





WATER

WATER

Angolari e porta oggetti in metallo

13

Cromato
lucido
Chromed

Corner shelves made of metal
Étagères d'angle réalisées en métal
Eckablagen hergestellt aus Metall
Estantes angulares realizados en metal
Угловая мыльница в душ из металла



2484

17,2 x 17,2 x 61,5 cm

Realizzato in ottone e acciaio inox
Made of brass and stainless steel
Réalisé en laiton et acier inoxydable
Hergestellt aus Messing und Edelstahl
Realizado en latón y acero inox
Изготовлено из латуни и нержавеющей стали



2482

20 x 15 x 32,8 cm

Realizzato in ottone e acciaio inox
Made of brass and stainless steel
Réalisé en laiton et acier inoxydable
Hergestellt aus Messing und Edelstahl
Realizado en latón y acero inox
Изготовлено из латуни и нержавеющей стали



2481

20 x 15 x 27 cm

Realizzato in ottone e acciaio inox
Made of brass and stainless steel
Réalisé en laiton et acier inoxydable
Hergestellt aus Messing und Edelstahl
Realizado en latón y acero inox
Изготовлено из латуни и нержавеющей стали

5412 G·LOUNGE

14 x 11 x 2,5 cm

Realizzato in alluminio e Cromall®
Made of aluminum and Cromall®
Réalisé en aluminium et Cromall®
Hergestellt aus Aluminium und Cromall®
Realizado en aluminio y Cromall®
Изготовлено из алюминия и Cromall®



5418 G·LOUNGE

24,6 x 13,7 x 2,5 cm

Realizzato in alluminio e Cromall®
Made of aluminum and Cromall®
Réalisé en aluminium et Cromall®
Hergestellt aus Aluminium und Cromall®
Realizado en aluminio y Cromall®
Изготовлено из алюминия и Cromall®



Realizzati in acciaio inox cromato
 Made of chromed stainless steel - Réalisés en acier inoxydable chromé
 Hergestellt aus verchromtem Edelstahl - Realizados en acero inox cromado
 Изготовлено из хромированной нержавеющей стали



2411

Design: Carlo Vietri
 12,5 x 10 x 3,5 cm



2419

24,8 x 10 x 8,6 cm

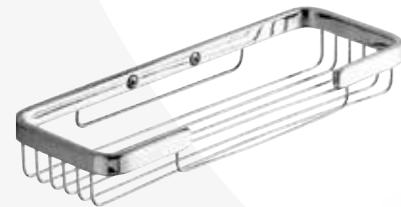

2418

Design: Carlo Vietri
 25 x 9,6 x 3,5 cm



2480

Design: Carlo Vietri
 19,3 x 19,3 x 3,5 cm



Fissaggio ad INCOLLO
 Fixes into place with adhesive
 Fixation par encollage
 Befestigung mit Klebstoff
 Fijación por medio de pegado
 Крепление клеем



2405

6 x 0,6 x 3,7 cm

Kit 2 placche ad incollo
 Pack of 2 plates with glue system - Kit 2 plaques à coller
 Packung mit 2 Wandplatten mit Klebefestigung
 Confección de 2 placas de pared con fijación con pegamento
 Набор 2 клеящихся пластин в комплекте с клеем

Cromall®

UTILIZZABILI CON I SEGUENTI ANGOLARI
 Can be mounted with - Peut être monté avec - Montierbar mit
 Pueden montarse con - Может быть установлена с:
 2418 - 2419 - 2480 - 2481 - 2482 - 2483 - 2484



2483

20 x 15 x 8,3 cm

HO20 G•HOT

27,5 x 13,6 x 12 cm

Metallo e resine termoplastiche
 Metal and thermoplastic resins
 Métal et thermoplastique
 Metall und Kunststoff
 Metal y resinas termoplásticas
 Металл и термопластичные смолы



SOLO SU SUPERFICI LISCE (SPECCHI, PIASTRELLE)
 FOR FLAT SURFACES (MIRRORS, TILES) ONLY

Fissaggio con ventosa - Suction cup fixing
 Fixation avec ventouses - Befestigung mit Saugnapfen
 Fijación con ventosas
 Крепление при помощи присосок



HO80 G•HOT

19 x 19 x 10 cm

Metallo e resine termoplastiche
 Metal and thermoplastic resins
 Métal et thermoplastique
 Metall und Kunststoff
 Metal y resinas termoplásticas
 Металл и термопластичные смолы

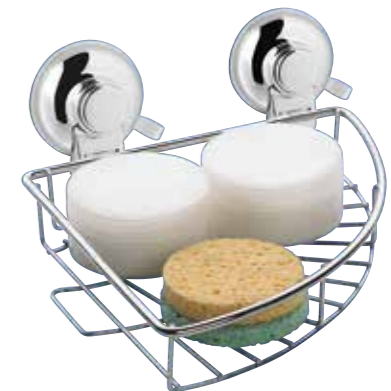

Angolari e porta oggetti in resine termoplastiche

Corner shelves made of thermoplastic resins - Etagères d'angle réalisés en thermoplastique
Eckablagen aus Kunststoff - Estantes angulares en resinas termoplásticas
Угловая мыльница в душ из термопластичных смол



2880 G•AVANT

Design: Original Designers 6R5

27,5 x 16,5 x 54,5 cm

02

Bianco
White

39

Bianco
pieno/
Trasparente
Solid white/
Transparent

89

Bianco/
Blu
White/
Blue



8079 G•JUNIOR

Design: R. & S. Prodotto Gedy

22 x 14 x 38 cm

02

Bianco
White

04

Verde acido
Acid green

67

Arancio
Orange



8081 G•JUNIOR

Design: R. & S. Prodotto Gedy

22 x 12 x 47 cm

02

Bianco
White



8080 G•JUNIOR

Design: Gianpietro Tonetti

19,6 x 15,6 x 3 cm

02

Bianco
White

Fissaggio con VITI o VENTOSE
To be fixed with suction cups
or screws
Fixation avec ventouses ou vis
Befestigung mit
Saugnapf oder Schrauben
Fijación con ventosas o tornillos
Крепление при помощи
присосок или шурупов

Dosatori

Soap dispensers - Distributeurs de savon - Seifenspender
Dosificadores de jabon - Ёмкость для жидкого мыла

13

Finitura lucida/
Polished/
finishing

2087 G•KUBIX

1200 ml. - 10 x 11 x 32 cm

**Realizzato in acciaio inox
e resine termoplastiche**

Made of stainless steel and thermoplastic resins

Réalisé en acier inoxydable et thermoplastique

Hergestellt aus Edelstahl und Kunststoff

Realizado en acero inox y resinas termoplásticas

Изготовлено из нержавеющей стали и термопластичных смол

Con chiave di sicurezza
With safety lock
Avec serrure de sûreté
Mit Sicherheitsschloß
Con cierre de seguridad
С ключ безопасности



21

Finitura lucida/
spazzolata
Polished/
brushed finishing

2081 G•EPOS

800 ml. - 11,5 x 10,5 x 18 cm

2082 G•EPOS

1200 ml. - cm. 12,7 x 10,5 x 20,3 cm

Realizzati in acciaio inox

Made of stainless steel

Réalisés en acier inoxydable

Hergestellt aus Edelstahl

Realizados en acero inox

Изготовлено из нержавеющей стали

Con chiave di sicurezza
With safety lock
Avec serrure de sûreté
Mit Sicherheitsschloß
Con cierre de seguridad
С ключ безопасности





2090 G • FEEL

500 ml. - 11 x 10,5 x 22,2 cm
4xAAA non include - not included

02

Bianco
White

CON FOTOCELLULA - WITH PHOTOCELL
AVEC DETECTEUR - DE MOUVEMENT
SEIFENSPENDER MIT LICHTSCHRANKE
CON FOTOCÉLULA - С ФОТОЭЛЕМЕНТОМ

Realizzato in resine termoplastiche

Made of thermoplastic resins
Réalisé en thermoplastique
Hergestellt aus Kunststoff
Realizado en resinas termoplásticas
Изготовлено из термопластичных смол

2088 G • TOUCH

500 ml. - 10,1 x 9,3 x 20,9 cm

02

Bianco
White

2089 G • TOUCH

1000 ml. - 11 x 10,5 x 27,5 cm

Realizzati in resine termoplastiche

Made of thermoplastic resins
Réalisés en thermoplastique
Hergestellt aus Kunststoff
Realizados en resinas termoplásticas
Изготовлено из термопластичных смол

02

Bianco
White

2280 G • PUSH

Design: Makio Hasuike

600 ml. - 11 x 9 x 20,8 cm

Realizzato in resine termoplastiche

Made of thermoplastic resins - Réalisé en thermoplastique
Hergestellt aus Kunststoff - Realizado en resinas termoplásticas
Изготовлено из термопластических смол



02

Bianco
White

13

Cromato
Chromed

2680 G • RALLY

500 ml. - 8,4 x 8,5 x 16,5 cm

2681 G • RALLY

1000 ml. - 10 x 11 x 20 cm

Realizzati in resine termoplastiche

Made of thermoplastic resins - Réalisés en thermoplastique
Hergestellt aus Kunststoff - Realizados en resinas termoplásticas
Изготовлено из термопластических смол



Tappeti antiscivolo

Non slip mats - Tapis anti dérapants - Rutsch sichere Matten
Alfombras antideslizantes - Анти-скользящие коврики

TRASPARENTI

Realizzati in PVC plastificato
Made of plasticized PVC - Réalisés en PVC plastifié
Hergestellt aus kunststoffbeschichtetem PVC
Realizados en PVC plastificado - Изготовлено из покрытый пластмассой PVC

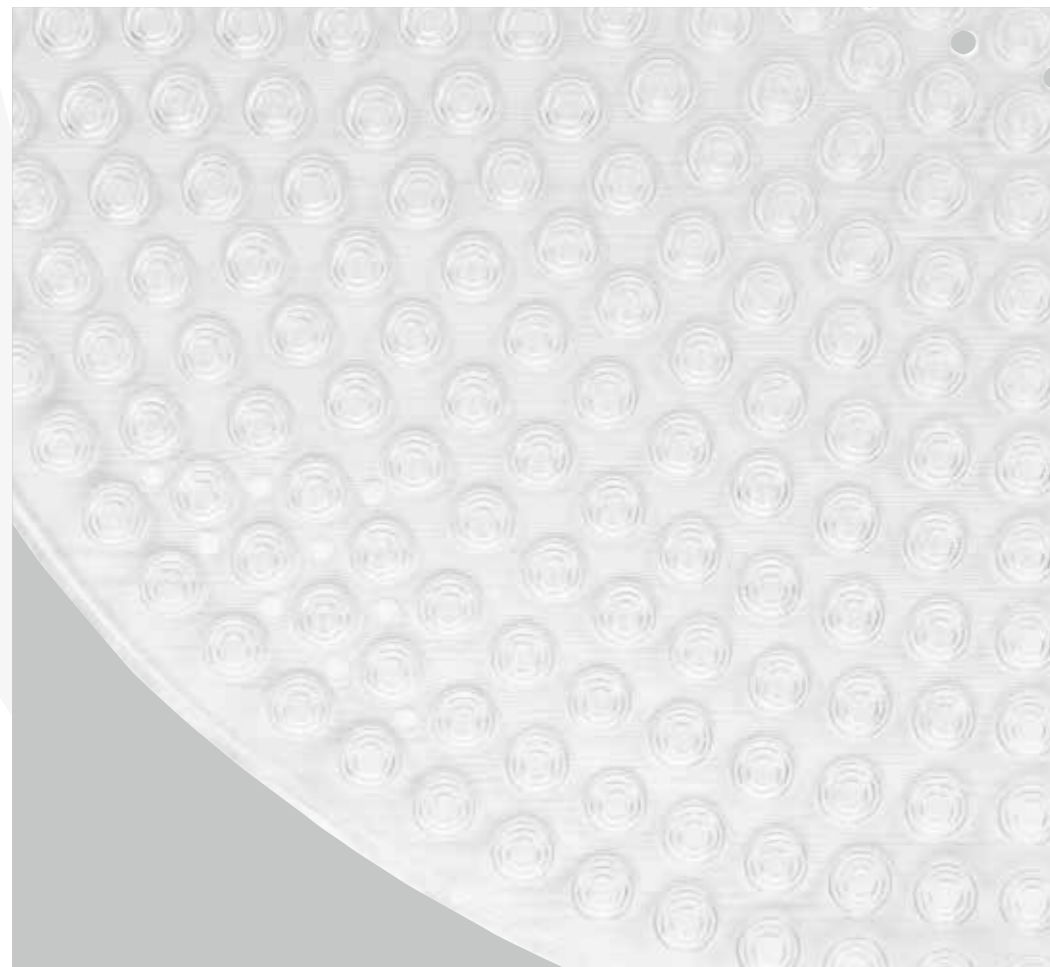

00
Trasparente
Transparent

G•PIETRA

Realizzati in vinile
Made of vinyl - Réalisés en vinyl
Hergestellt aus Vinyl - Realizados en vinilo
Изготовлено из винила



02 **08** **85**
Bianco White Grigio Grey Antracite Anthracite



975858
60 x 60 cm



976060
60 x 60 cm



978060
80 x 60 cm

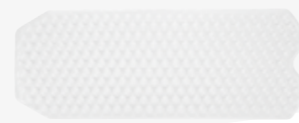

971040
104 x 40 cm



CO5656
55 x 55 cm

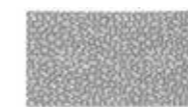

CO3475
36 x 75 cm

G•GIOTTO

Realizzato in gomma
 Made of rubber - Réalisé en caoutchouc
 Hergestellt aus Gummi - Realizados en goma
 Изготовлено из каучук

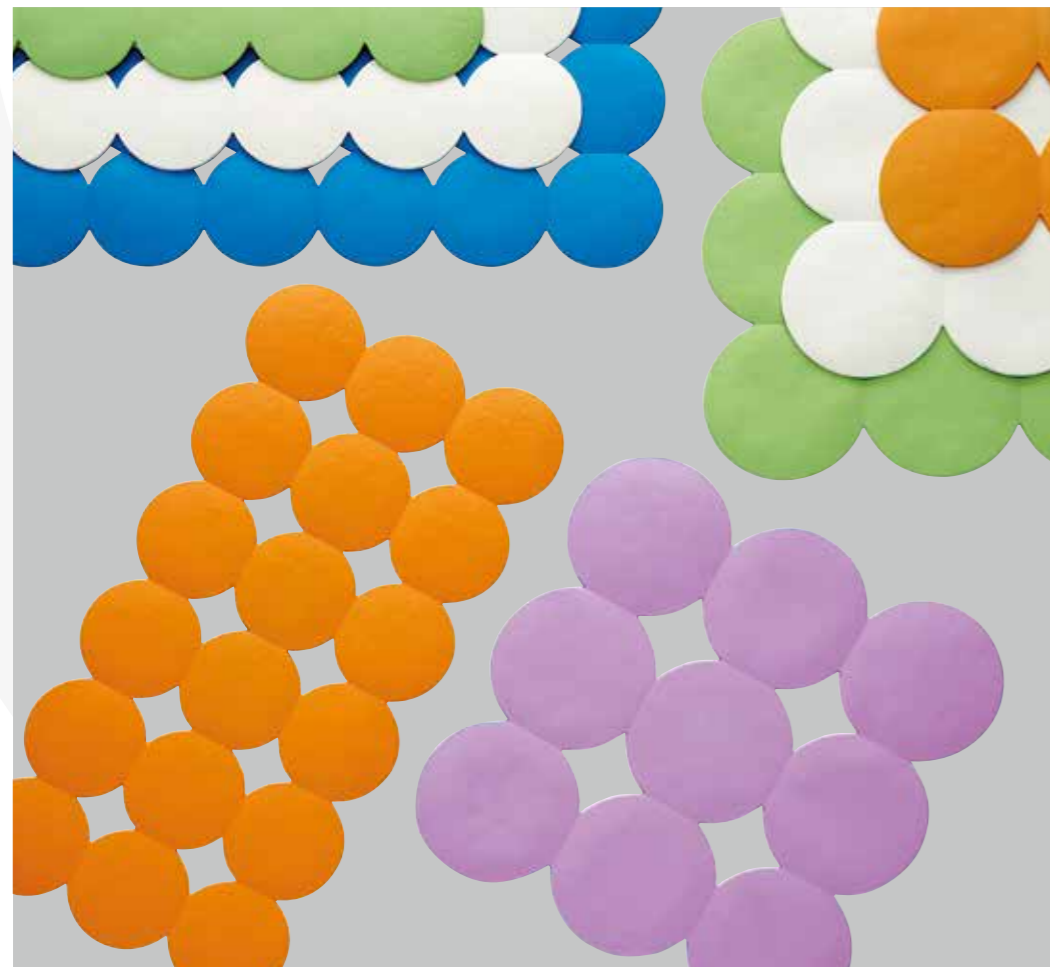

- 02 Bianco
White
- 04 Verde acido
Acid green
- 11 Azzurro
Light blue
- 67 Arancio
Orange
- 79 Lilla
Lilac



985555
54,5 x 54,5 cm



983979
79 x 39,5 cm



- 02 Bianco
White
- 03 Beige
- 19 Marrone
Brown



CO5454
55 x 55 cm



CO3575
36 x 75 cm

G•SABBIA

Realizzati in vinile
 Made of vinyl - Réalisés en vinyl
 Hergestellt aus Vinyl - Realizados en vinilo
 Изготовлено из винила

G·MARGHERITA

Realizzati in PVC
 Made of PVC - Réalisés en PVC
 Hergestellt aus PVC - Realizados en PVC
 Изготовлено из PVC



- | | | |
|--------------------------------|------------------------------------|-----------------------------------------|
| P0
Fucsia
Fuxia | P1
Azzurro
Light blue | P2
Trasparente
Transparent |
| P4
Arancio
Orange | P8
Verde
Green | P9
Lilla
Lilac |



975151
51,5 x 51,5 cm

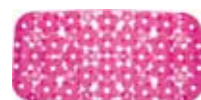

973572
72 x 34,5 cm

G·CUORE

Realizzati in vinile
 Made of vinyl - Réalisés en vinyl
 Hergestellt aus Vinyl - Realizados en vinilo
 Изготовлено из винила



- | | | |
|-----------------------------------------|----------------------------------------|------------------------------------|
| 00
Trasparente
Transparent | 04
Verde acido
Acid green | 11
Azzurro
Light blue |
| 67
Arancio
Orange | 76
Fucsia
Fuchsia | 79
Lilla
Lilac |

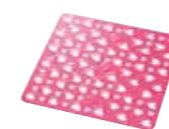

CO5555
55 x 55 cm



CO3675
36 x 75 cm

G•MIAO

Realizzati in PVC
Made of PVC - Réalisés en PVC - Hergestellt aus PVC
Realizados en PVC - Изготовлено из PVC



col. 7743
Bianco/Nero
White/Black



9755
55 x 55 cm



9782
36 x 71 cm

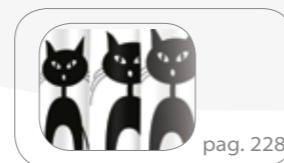

pag. 228

02

Bianco
White

02

Bianco
White

TINTA UNITA

Realizzati in PVC espanso
Made of foam PVC
Réalisés en PVC expansé
Hergestellt aus verschäumtem PVC
Realizados en PVC
Изготовлено из вспученный PVC

975555
55 x 55 cm

973782
82 x 36 cm



TINTA UNITA

Realizzati in gomma
Made of rubber
Réalisés en caoutchouc
Hergestellt aus Gummi
Realizados en goma
Изготовлено из каучука

985353
52,5 x 52,5 cm

983672
71 x 36 cm

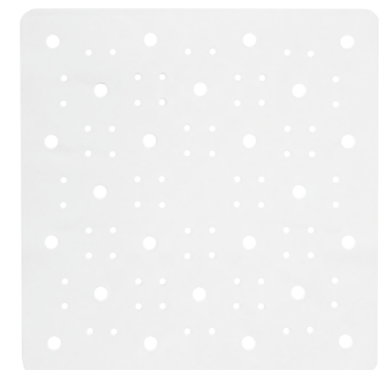

G • GEO

Realizzati in gomma
 Made of rubber - Réalisés en caoutchouc
 Hergestellt aus Gummi - Realizados en goma
 Изготовлено из каучука

- | | | |
|------------------------------|------------------------------------|----------------------------------------|
| 02
Bianco
White | 03
Beige
Beige | 04
Verde acido
Acid green |
| 05
Blu
Blue | 11
Azzurro
Light blue | 67
Arancio
Orange |

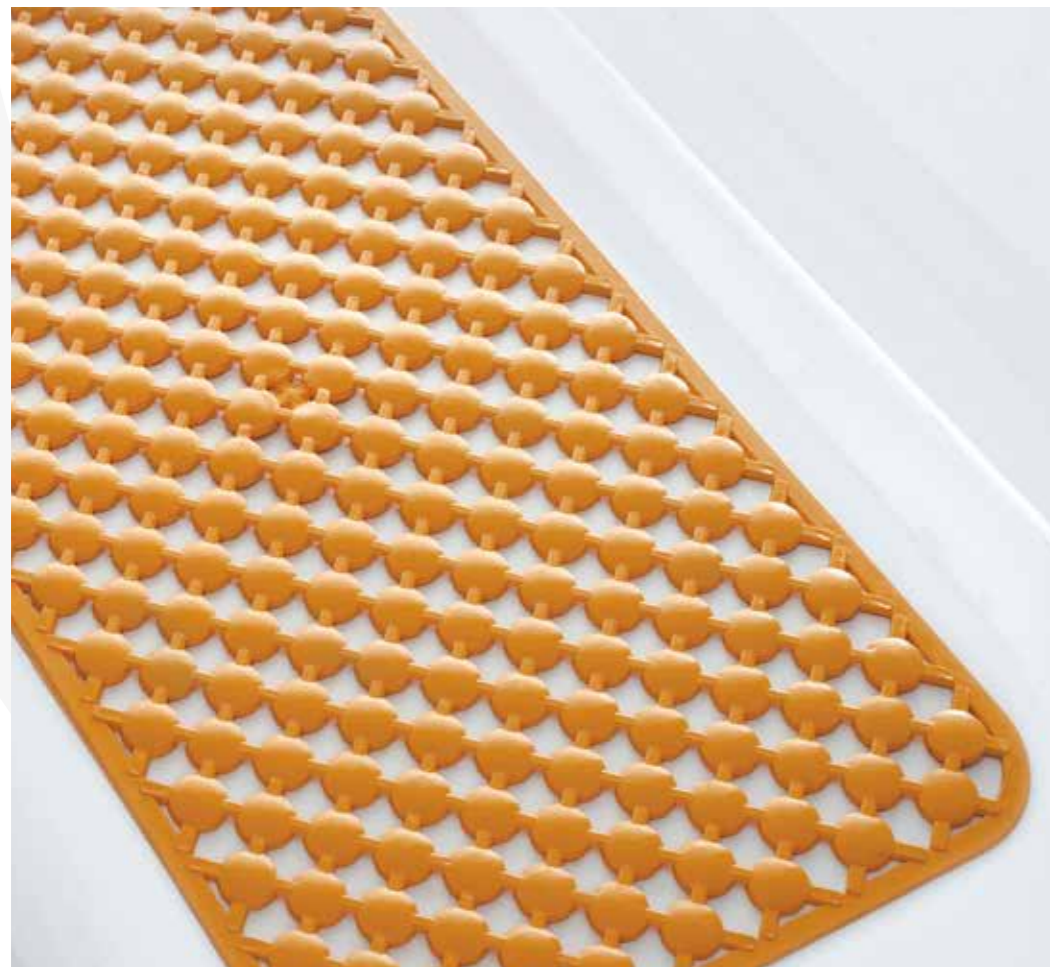

975353
53 x 53 cm

973671
36 x 71 cm

9789

Poggiatesta vasca
 Bath tub head rest - Repose-tête baignoire - Kopfstütze Wanne
 Ароуа-савеба баñера - Подушка для ванной

Realizzato in PVC espanso
 Made of PVC foam
 Réalisé en PVC expansé
 Hergestellt aus PVC-Schaumstoff
 Realizado en PVC expandido
 Изготовлено из вспененный ПВХ



02
Bianco
White



9789
28 x 3 x 38 cm

Pedane doccia

Shower platforms - Caillebotis - Duschroste
Tarimas para ducha - Платформа в душ

G • LIDO

Realizzata in resine termoplastiche
Made of thermoplastic resins - Réalisé en thermoplastique
Hergestellt aus Kunststoff - Realizada en resinas termoplásticas
Изготовлено из ётермопластичных смол

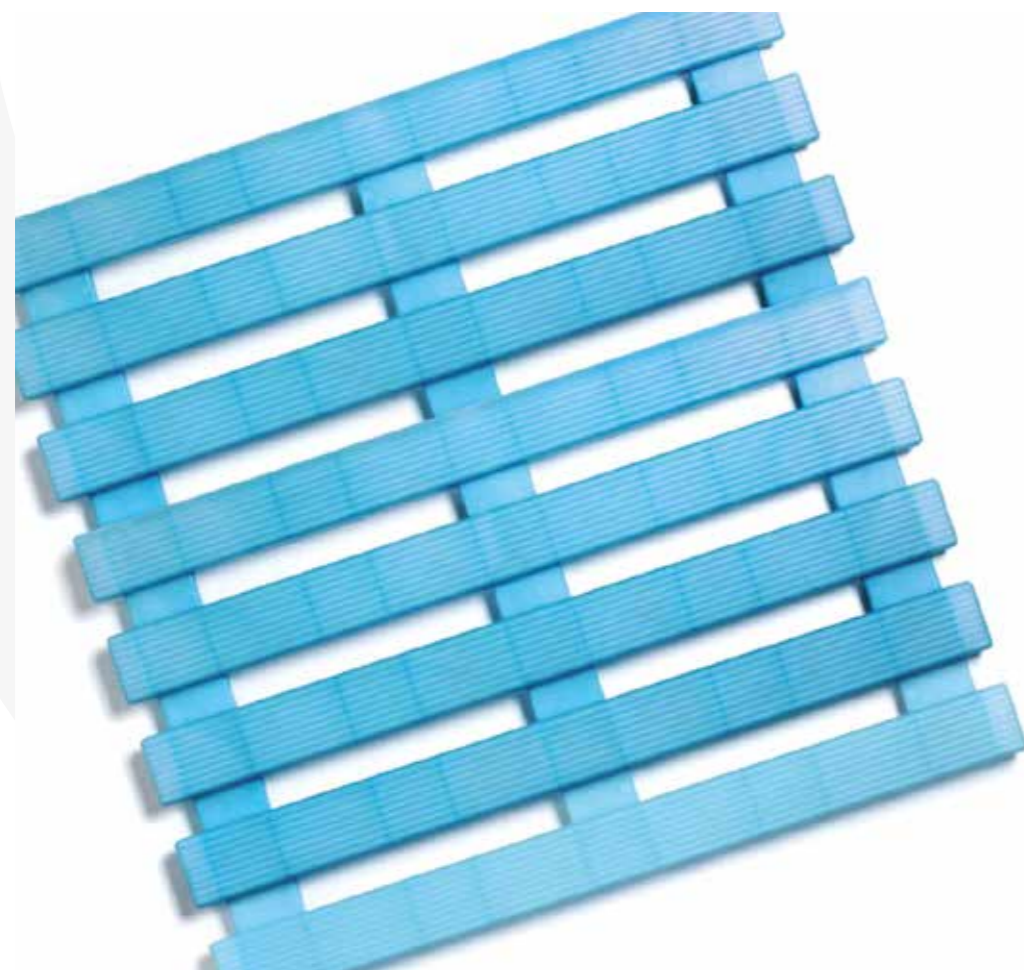

02 **P1**
Bianco White
Azzurro opalino Opaline blue

Con piedini in gomma antiscivolo
With non-slip rubber feet
Avec des pieds en caoutchouc antidérapants
Mit rutschfesten Gummifüßen
Con pies de goma antideslizantes
С нескользящей резиновой ног



CO83

58,2 x 57,5 x 3 cm

G • FIORILÙ

Design: R. & S. Prodotto Gedy

Realizzata in resine termoplastiche
Made of thermoplastic resins - Réalisé en thermoplastique - Hergestellt aus Kunststoff
Realizada en resinas termoplásticas - Изготовлено из термопластичных смол



2682
55 x 1,7 x 55 cm



Sedili per doccia e vasca

Shower and bath tub seats - Sièges pour douche et baignoire - Dusch- und Badewannensitze - Asientos para ducha y bañera - Сидение в душ и ванну



2284 G • SICURA

64 x 32,4 x 18,3 cm

Braccioli estensibili per vasche con misura interna di 50-65 cm

Extendable arms for baths with internal measurement 50-60 cm

Bras extensibles pour baignoires aux dimensions intérieures de 50-60 cm

Verlängerbare Armlehnen für Wannen mit einem Innenmaß von 50-60 cm

Apoyabrazos extensibles para bañeras con medidas interiores de 50-60 cm

Выдвижные поручни для ванны, имеющей внутреннюю ширину от 50 до 60 см

Realizzato in resine termoplastiche e alluminio

Made of thermoplastic resins and aluminum

Réalisé en thermoplastique et aluminium

Hergestellt aus Kunststoff und Aluminium

Realizado en resinas termoplásticas y aluminio

Изготовлено из термопластичных смол и алюминия

02

Bianco
White

02

Bianco
White

23

Bianco/cromo
White/chromed

43

Antracite/
cromo
Anthracite/
chromed



— 4,8 —

6083

35,5 x 37 x 10,5 cm

Sedile ribaltabile per doccia alluminio/ABS

Shower seat - aluminum/ABS

Siège pour douche repliable aluminium/ABS

Duschsitz hochklappbar Aluminium/ABS

Asiento móvil para ducha aluminio/ABS

Сиденье для душа алюминий/ABS

Design: Studio Talocci

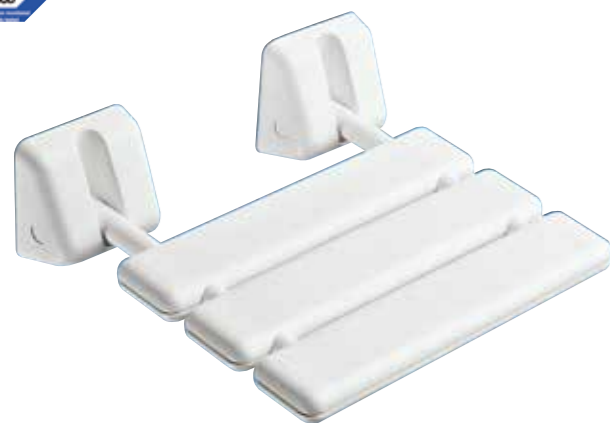

2283 G • SICURA

34,5 x 34,5 x 10,5 cm

Sedile per doccia ribaltabile

Tilt-up shower seat

Siège pour douche repliable

Duschsitz hochklappbar

Asiento para ducha móvil

Откидное сидение в душ

Realizzato in resine termoplastiche e alluminio

Made of thermoplastic resins and aluminum

Réalisé en thermoplastique et aluminium

Hergestellt aus Kunststoff und Aluminium

Realizado en resinas termoplásticas y aluminio

Изготовлено из термопластичных смол и алюминия

02

Bianco
White

02

Bianco
White

23

Bianco lucido/
cromato lucido
White/chromed



2282 G • SOUND

38,5 x 35,4 x 15,2 cm

Sedile ribaltabile per doccia

Tilt-up shower seat

Siège pour douche repliable

Duschsitz hochklappbar

Asiento para ducha móvil

Откидное сидение в душ

Realizzato in resine termoplastiche e acciaio

Made of thermoplastic resins and steel

Réalisé en thermoplastique et acier

Hergestellt aus Kunststoff und Stahl

Realizado en resinas termoplásticas y acero

Изготовлено из термопластичных смол и стали



TEST CONDOTTI DALL'ISTITUTO DI CERTIFICAZIONE QUALITÀ CABIATE (CO)

TESTED BY ISTITUTO DI CERTIFICAZIONE QUALITÀ CABIATE (CO)

Tende doccia

Shower curtains - Rideaux de douche
Duschvorhänge - Cortinas de baño - Занавески для ванной



DINO G • DINO

37,5 x 29,5 x 7 cm

Sedile ribaltabile per doccia

Tilt-up shower seat

Siège pour douche repliable

Duschsitz hochklappbar

Asiento para ducha móvil

Откидное сидение в душ

Realizzato in resine termoplastiche

Made of thermoplastic resins

Réalisé en thermoplastique

Hergestellt aus Kunststoff

Realizado en resinas termoplásticas

Изготовлено из термопластичных смол

02

Bianco
White

120
kg



TEST CONDOTTI DALL'ISTITUTO DI CERTIFICAZIONE
QUALITÀ CABIATO (CO)

TESTED BY ISTITUTO DI CERTIFICAZIONE QUALITÀ CABIATO (CO)

SIMBOLOGIA



PVC calandrato trasparente inciso o stampato - PVC embossed or printed - PVC grainé ou imprimé - PVC geprägt oder bedrückt
PVC calandrado grabado o estampado - Прозрачные коврики из PVC с рельефным или печатным узором



100% poliestere impermeabilizzato - 100% polyester waterproof - 100% polyester imperméable - 100% Polyester wasserfest
100% poliester impermeabilizado - 100% водонепроницаемый полиэстер

Tende doccia in TESSUTO

Le tende doccia in tessuto Gedy sono realizzate in Poliestere al 100% e trattate con TEFLON® fabric protector di DuPont® per renderle impermeabili e resistenti alle macchie. Il tessuto ed i colori utilizzati sono certificati Öko-Tex Standard 100. L'orlo inferiore contiene un filo di polipropilene per mantenere la tenda in ordine e sempre tesa. La tenda è fornita completa di ganci. Ogni tenda è garantita per 3 anni e a certificarne l'originalità è presente un'etichetta cucita nell'orlo superiore.

Les rideaux de douche en tissu de Gedy sont fabriqués en Polyester 100%, ils ont un traitement à la résine pour les rendre imperméables et résistants aux taches (TEFLON® fabric protector). Le tissu et les couleurs utilisés sont certifiés Öko-Tex Standard 100. L'ourlet en bas contient un fil de polypropylène pour maintenir le rideau rangé et toujours tendu. Le rideau de douche est livré avec anneaux. Chaque rideau est garanti pour 3 ans et pour certifier l'originalité il y a une étiquette cousue dans l'ourlet en haut.

Las cortinas de tejido Gedy están hechas de 100% poliéster y están tratadas con TEFLON® fabric protector de DuPont, para que sean impermeables y resistentes a las manchas. El tejido y los colores utilizados están certificados Öko-tex Standard 100. El borde inferior contiene un hilo de polipropileno para que la cortina esté siempre en orden y tesa. La cortina se suministra completa de ganchos. Todas las cortinas tienen una garantía de 3 años y, para certificar su originalidad, llevan una etiqueta cocida en el borde superior.

Gedy fabric shower curtains are made in Polyester 100% treated with waterproof resin (TEFLON® fabric protector by DuPont®). The raw materials and colours are Öko-Tex Standard 100 certified. Into the hem there is a polypropylene thread in order to have the curtains always tidy and tight. All curtains are supplied with hooks. Each shower curtain is 3 years guaranteed and a label on the upper border certifies its originality.

Gedy Textil-Duschvorhänge sind aus 100% Polyester und mit Gewebe imprägniert, um sie wasserabweisend zu machen (TEFLON® fabric protector). Stoff und Farben sind nach Öko-Tex Standard 100 zertifiziert. Im unteren Saum ist ein Beschwerungsband aus Polypropylen eingearbeitet, was dafür sorgt, dass der Duschvorhang immer ordentlich bleibt und "fällt". Der Duschvorhang wird komplett mit Haken geliefert. Jeder Duschvorhang hat eine 3 Jahre Garantie. Im oberen Saum ist ein Etikett eingenäht, das seine Echtheit bestätigt.

Занавески из ткани Gedy изготовлены из 100% полиэстера и обработаны защитным материалом TEFLON® fabric protector фирмы DuPont для обеспечения водонепроницаемости и стойкости к образованию пятен. Используемые ткань и расцветка прошли сертификацию Öko-tex Standard 100. Нижняя кромка с полипропиленовой нитью для поддержания натяжения и порядка. К занавеске прилагаются крючки. Каждая занавеска имеет гарантию 3 года. На верхней кромке занавески пришита этикетка, указывающая на происхождение изделия.



DELUXE

G•TINTA UNITA

cod. 6129
Bianco
White
Blanc
Weiss
Blanco
Белый

cm. 120 x 200 **6012**
cm. 180 x 200 **6018**
cm. 240 x 200 **6024**

Anelli inclusi - Rings included
Anneaux fournis - Ringe inklusiv
Anillos incluidos - Кольца включены



DELUXE

G•CANNETO design Massimo Tomboloni

cod. 7713
Verde
Green
Vert
Grün
Verde
Зелёный

cm. 120 x 200 **6012**
cm. 180 x 200 **6018**
cm. 240 x 200 **6024**

Anelli inclusi - Rings included
Anneaux fournis - Ringe inklusiv
Anillos incluidos - Кольца включены



DELUXE

G•CATS design: Piera Croveti, Francesca Tinelli

cod. 4176
Bianco/Grigio/Nero
White/Grey/Black
Blanc/Gris/Noir
Weiss/Grau/Schwarz
Blanco/Gris/Negro
Белый/Серый/Чёрный

cm. 120 x 200 **6012**
cm. 180 x 200 **6018**
cm. 240 x 200 **6024**

Anelli inclusi - Rings included
Anneaux fournis - Ringe inklusiv
Anillos incluidos - Кольца включены



DELUXE

G•CONCHIGLIE design: Marina Montagioli

cod. 7714
Celeste
Sky-blue
Blue
Himmelblau
Celeste
Голубой

cod. 7715
Beige
Beige
Beige
Beige
Champagne
Бежвый

cm. 120 x 200 **6012**
cm. 180 x 200 **6018**
cm. 240 x 200 **6024**

Anelli inclusi - Rings included
Anneaux fournis - Ringe inklusiv
Anillos incluidos - Кольца включены



DELUXE

G•CORALLO design Gabriele Vella

 cod. 7716
Rosso corallo
Coral red
Rouge
Rot
Rojo
Красный

cm. 120 x 200 **6012**
cm. 180 x 200 **6018**
cm. 240 x 200 **6024**

Anelli inclusi - Rings included
Anneaux fournis - Ringe inklusiv
Anillos incluidos - Кольца вклучены 



DELUXE

G•DAFNE design Laura Giraldo

 cod. 7717
Rosso
Red
Rouge
Rot
Rojo
Красный

 cod. 7718
Lilla
Lilac
Lilas
Fieder
Lila
Сирень

cm. 120 x 200 **6012**
cm. 180 x 200 **6018**
cm. 240 x 200 **6024**

Anelli inclusi - Rings included
Anneaux fournis - Ringe inklusiv
Anillos incluidos - Кольца вклучены 



DELUXE

G•DAKAR design C. Parrino - G. Vella

 cod. 7720
Giallo/nero
Yellow/black
Jaune/noir
Gelb/Schwarz
Amarillo/negro
Желтый/чёрный

cm. 120 x 200 **6012**
cm. 180 x 200 **6018**
cm. 240 x 200 **6024**

Anelli inclusi - Rings included
Anneaux fournis - Ringe inklusiv
Anillos incluidos - Кольца вклучены 



DELUXE

G•DAMA design Gabriele Vella

 cod. 7719
Bianco
White
Blanc
Weiss
Blanco
белый

cm. 120 x 200 **6012**
cm. 180 x 200 **6018**
cm. 240 x 200 **6024**

Anelli inclusi - Rings included
Anneaux fournis - Ringe inklusiv
Anillos incluidos - Кольца вклучены 



DELUXE

G-FONDALE design Massimo Tomboloni



cod. 7739
Giallo
Yellow
Jaune
Gelb
Amarillo
Желтый

cm. 120 x 200 **6012**
cm. 180 x 200 **6018**
cm. 240 x 200 **6024**

Anelli inclusi - Rings included
Anneaux fournis - Ringe inklusiv
Anillos incluidos - Кольца вклучены



DELUXE

G-GIUNGLA



cod. 7722
Verde
Green
Vert
Grün
Verde
Зелёный

cm. 120 x 200 **6012**
cm. 180 x 200 **6018**
cm. 240 x 200 **6024**

Anelli inclusi - Rings included
Anneaux fournis - Ringe inklusiv
Anillos incluidos - Кольца вклучены

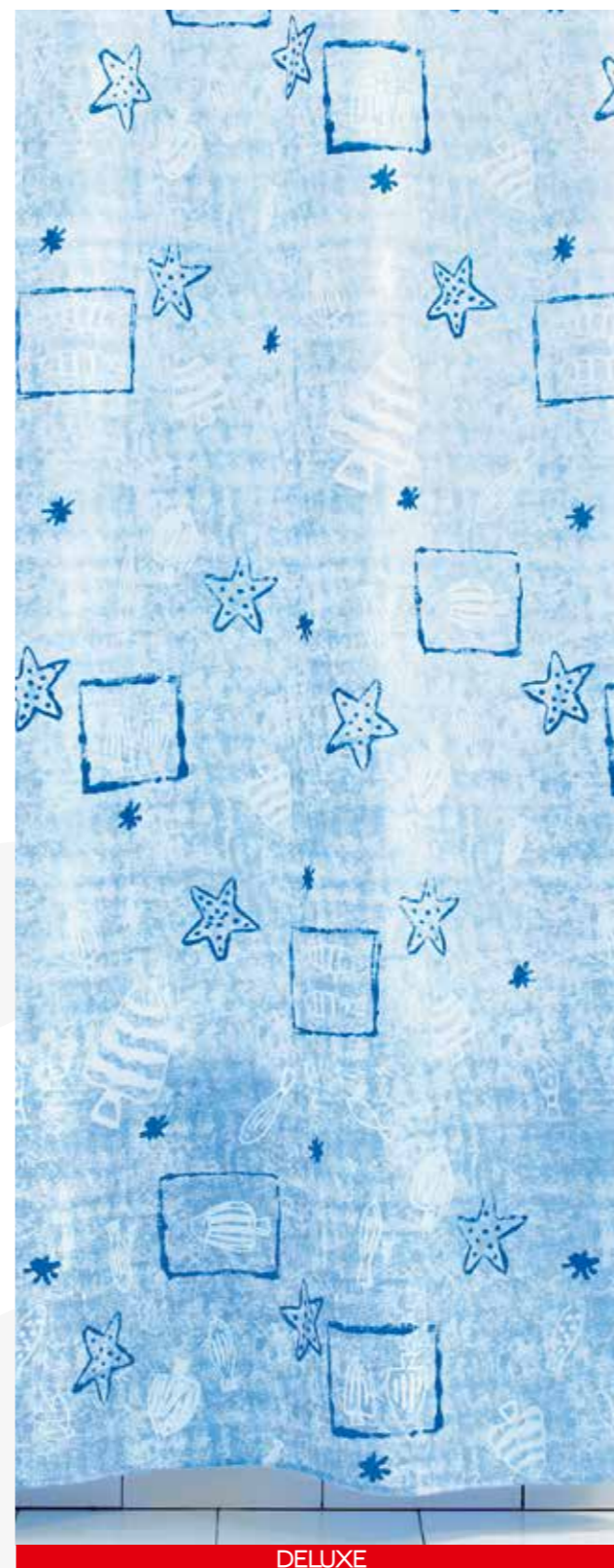

DELUXE

G-MAREA design Laura Giraldo



cod. 7725
Blu
Blue
Bleu
Blau
Azulón
Синий

cm. 120 x 200 **6012**
cm. 180 x 200 **6018**
cm. 240 x 200 **6024**

Anelli inclusi - Rings included
Anneaux fournis - Ringe inklusiv
Anillos incluidos - Кольца вклучены



DELUXE

G-MAR ROSSO design R. & S. Prodotto Gedy



cod. 6280
Multicolore
Multicolour
Multicolore
Mehrfarbig
Multicolor
Многоцветный

cm. 120 x 200 **6012**
cm. 180 x 200 **6018**
cm. 240 x 200 **6024**

Anelli inclusi - Rings included
Anneaux fournis - Ringe inklusiv
Anillos incluidos - Кольца вклучены





DELUXE

G•MIAO design C. Parrino - G. Vella



cod. 7743
Bianco/nero
White/black
Blanc/noir
Weiss/Schwarz
Blanco/negro
Белый/чёрный



pag. 212

cm. 120 x 200 **6012**
cm. 180 x 200 **6018**
cm. 240 x 200 **6024**

Anelli inclusi - Rings included
Anneaux fournis - Ringe inklusiv
Anillos incluidos - Кольца вклучены



DELUXE

G•OLANDA design Gabriele Vella



cod. 7740
Bianco/rosso/verde
White/red/green
Blanc/rouge/vert
Weiss/Rot/Grün
Blanco/rojo/verde
Белый/красный/зелёный

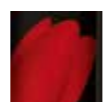

cod. 7742
Nero/bianco/rosso
Black/white/red
Noir/blanc/rouge
Schwarz/Weiss/Rot
Negro/blanco/rojo
Чёрный/белый/красный

cm. 120 x 200 **6012**
cm. 180 x 200 **6018**
cm. 240 x 200 **6024**

Anelli inclusi - Rings included
Anneaux fournis - Ringe inklusiv
Anillos incluidos - Кольца вклучены



DELUXE

G•OMINI design Danilo Limoni



cod. 7726
Bianco/nero
White/black
Blanc/noir
Weiss/Schwarz
Blanco/negro
Белый/чёрный

cm. 120 x 200 **6012**
cm. 180 x 200 **6018**
cm. 240 x 200 **6024**

Anelli inclusi - Rings included
Anneaux fournis - Ringe inklusiv
Anillos incluidos - Кольца вклучены



DELUXE

G•PENG



cod. 7727
Bianco/nero
White/black
Blanc/noir
Weiss/Schwarz
Blanco/negro
Белый/чёрный

cm. 120 x 200 **6012**
cm. 180 x 200 **6018**
cm. 240 x 200 **6024**

Anelli inclusi - Rings included
Anneaux fournis - Ringe inklusiv
Anillos incluidos - Кольца вклучены



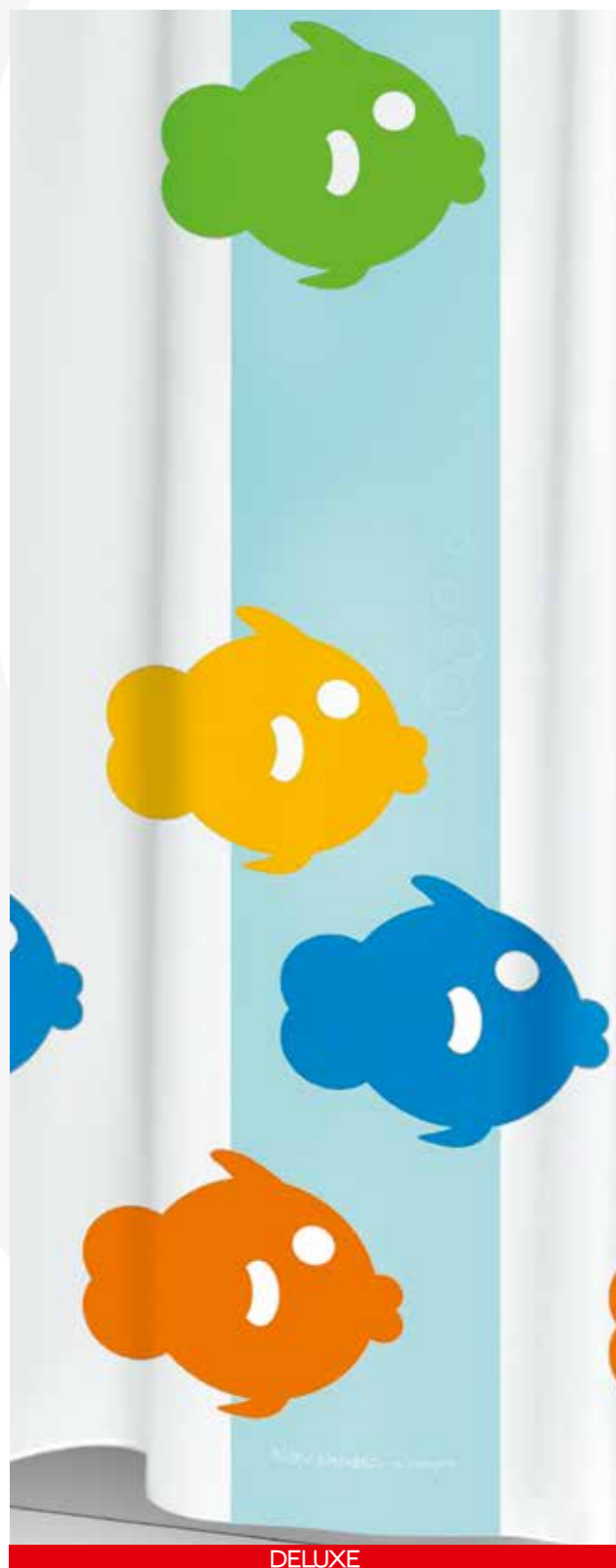

DELUXE

G•PESCE PALLA design Gabriele Vella



cod. 7723
 Multicolore
 Multicolor
 Multicolore
 Mehrfarbig
 Multicolor
 Разноцветный

cm. 120 x 200 **6012**
 cm. 180 x 200 **6018**
 cm. 240 x 200 **6024**

Anelli inclusi - Rings included
 Anneaux fournis - Ringe inklusiv
 Anillos incluidos - Кольца вклучены



DELUXE

G•PIC NIC design R.&S. Prodotto Gedy



cod. 4039
 Bianco
 White
 Blanc
 Weiss
 Blanco
 Белый

cm. 120 x 200 **6012**
 cm. 180 x 200 **6018**
 cm. 240 x 200 **6024**

Anelli inclusi - Rings included
 Anneaux fournis - Ringe inklusiv
 Anillos incluidos - Кольца вклучены

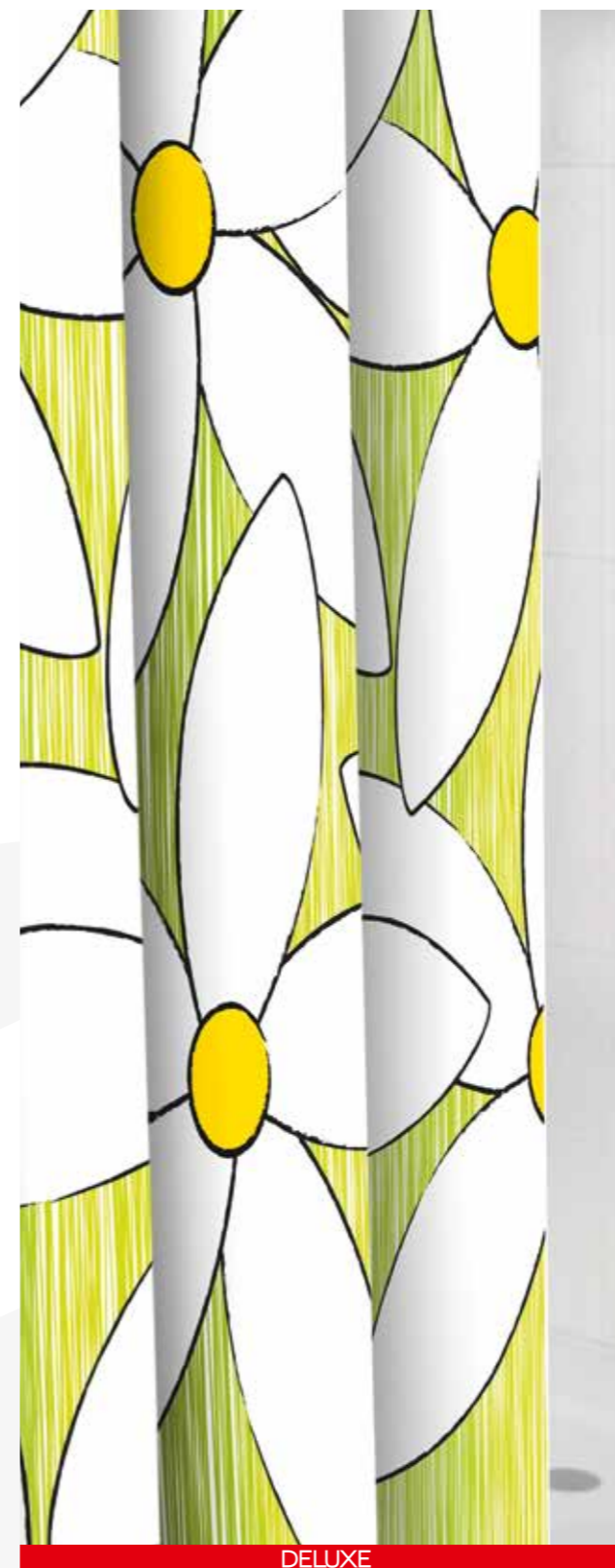

DELUXE

G•PRATO FIORITO design Gabriele Vella



cod. 7724
 Verde acido
 Acid green
 Vert acide
 Pfefferminz
 Verde acido
 Ярко-зелёный

cm. 120 x 200 **6012**
 cm. 180 x 200 **6018**
 cm. 240 x 200 **6024**

Anelli inclusi - Rings included
 Anneaux fournis - Ringe inklusiv
 Anillos incluidos - Кольца вклучены



DELUXE

G•QUADRETTO



cod. 7728
 Bianco
 White
 Blanc
 Weiss
 Blanco
 Белый

cm. 120 x 200 **6012**
 cm. 180 x 200 **6018**
 cm. 240 x 200 **6024**

Anelli inclusi - Rings included
 Anneaux fournis - Ringe inklusiv
 Anillos incluidos - Кольца вклучены



DELUXE

G•RICCIOLO design Stefania Borioli

- | | | |
|--------------------------------------------------------------------------------------------------------------------------------------------------|------------------------------------------------------------------------------------------------------------------------------------------------------------------------------------------|------------------------------------------------------------------------------------------------------------------------------------------------------|
|  cod. 7729
Rosa
Pink
Rose
Rosa
Rosa
Розовый |  cod. 7730
Tortora
Turtledove grey
Gris tourterelle
Taubengrau
Gris tórtora
Тортора |  cod. 7731
Lilla
Lilac
Lilas
Fieder
Lila
Сирень |
|--------------------------------------------------------------------------------------------------------------------------------------------------|------------------------------------------------------------------------------------------------------------------------------------------------------------------------------------------|------------------------------------------------------------------------------------------------------------------------------------------------------|



- cm. 120 x 200 **6012**
cm. 180 x 200 **6018**
cm. 240 x 200 **6024**

Anelli inclusi - Rings included
Anneaux fournis - Ringe inklusiv
Anillos incluidos - Кольца вклучены 



DELUXE

G•RIGHE design Gabriele Vella

- | | |
|-------------------------------------------------------------------------------------------------------------------------------------------------|----------------------------------------------------------------------------------------------------------------------------------------------------|
|  cod. 7732
Blu
Blue
Bleu
Blau
Azulón
Синий |  cod. 7733
Rosso
Red
Rouge
Rot
Rojo
Красный |
|-------------------------------------------------------------------------------------------------------------------------------------------------|----------------------------------------------------------------------------------------------------------------------------------------------------|

- cm. 120 x 200 **6012**
cm. 180 x 200 **6018**
cm. 240 x 200 **6024**

Anelli inclusi - Rings included
Anneaux fournis - Ringe inklusiv
Anillos incluidos - Кольца вклучены 



DELUXE

G•RIGONE

- | | | | |
|---------------------------------------------------------------------------------------------------------------------------------------------------------|----------------------------------------------------------------------------------------------------------------------------------------------------|--------------------------------------------------------------------------------------------------------------------------------------------------------------------|------------------------------------------------------------------------------------------------------------------------------------------------------------|
|  cod. 7734
Bianco
White
Blanc
Weiss
Blanco
Белый |  cod. 7735
Rosa
Pink
Rose
Rosa
Rosa
Розовый |  cod. 7737
Celeste
Sky-blue
Blue
Himmelblau
Celeste
Голубой |  cod. 7736
Beige
Beige
Beige
Beige
Champagne
Бежвый |
|---------------------------------------------------------------------------------------------------------------------------------------------------------|----------------------------------------------------------------------------------------------------------------------------------------------------|--------------------------------------------------------------------------------------------------------------------------------------------------------------------|------------------------------------------------------------------------------------------------------------------------------------------------------------|

- cm. 120 x 200 **6012**
cm. 180 x 200 **6018**
cm. 240 x 200 **6024**

Anelli inclusi - Rings included
Anneaux fournis - Ringe inklusiv
Anillos incluidos - Кольца вклучены 



DELUXE

G•SAVANA design Roberta Bianchi

- | |
|-----------------------------------------------------------------------------------------------------------------------------------------------------------------------------------------------------------|
|  cod. 7738
Marrone/bianco
Brown/white
Marron/blanc
Braun/Weiss
Marrón/blanco
Коричневый цвет/белый |
|-----------------------------------------------------------------------------------------------------------------------------------------------------------------------------------------------------------|

- cm. 120 x 200 **6012**
cm. 180 x 200 **6018**
cm. 240 x 200 **6024**

Anelli inclusi - Rings included
Anneaux fournis - Ringe inklusiv
Anillos incluidos - Кольца вклучены 



G•AFRICA



cod. 107
Marrone/Beige/Nero
Brown/Beige/Black
Marron/Beige/Noir
Braun/Beige/Schwarz
Marrón/Beige/Negro
Коричневый цвет/беж/Чёрный

cm. 180 x 200 **CO118**

Anelli inclusi - Rings included
Anneaux fournis - Ringe inklusiv
Anillos incluidos - Кольца вклучены



G•AUTUNNO



cod. 102
Bianco
White
Blanc
Weiss
Blanco
Белый

cm. 120 x 200 **CO112**
cm. 180 x 200 **CO118**
cm. 240 x 200 **CO124**

Anelli inclusi - Rings included
Anneaux fournis - Ringe inklusiv
Anillos incluidos - Кольца вклучены

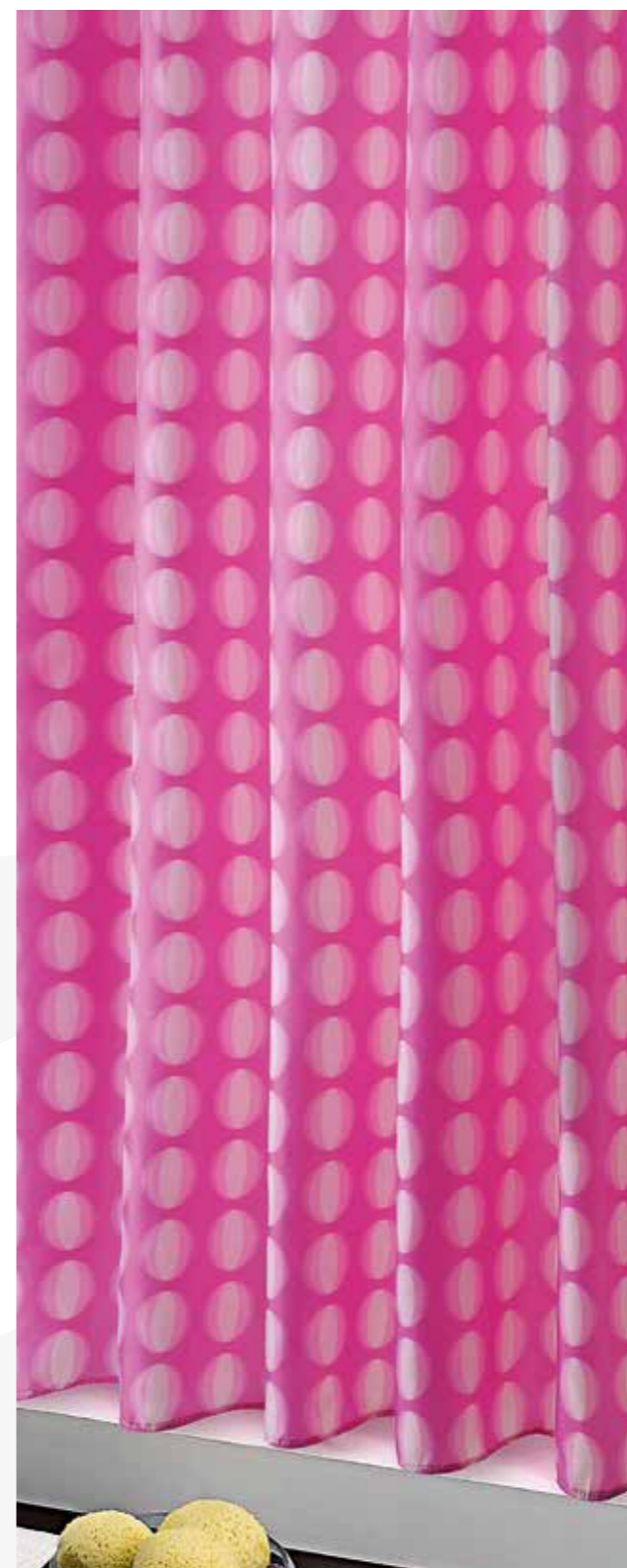

G•CELL design Studio Affabre



cod. 115
Antracite
Anthracite
Anthracite
Anthraxit
Antracita
Серый



cod. 116
Fucsia
Fuchsia
Fuchsia
Fuchsie
Fucsia
Фуксия

cm. 120 x 200 **CO112**
cm. 180 x 200 **CO118**
cm. 240 x 200 **CO124**

Anelli inclusi - Rings included
Anneaux fournis - Ringe inklusiv
Anillos incluidos - Кольца вклучены



G•GOCCE



cod. 117
Multicolore
Multicolour
Multicolore
Mehrfarbig
Multicolor
Многоцветный

cm. 120 x 200 **CO112**
cm. 180 x 200 **CO118**
cm. 240 x 200 **CO124**

Anelli inclusi - Rings included
Anneaux fournis - Ringe inklusiv
Anillos incluidos - Кольца вклучены



G•LEAF design Carlo Sampietro



cod. 104
Beige/Marrone
Beige/Brown
Beige/Marron
Beige/Braun
Champagne/Marrón
Бежвый/Коричневый цвет

cm. 120 x 200 **C0112**
cm. 180 x 200 **C0118**
cm. 240 x 200 **C0124**

Anelli inclusi - Rings included
Anneaux fournis - Ringe inklusiv
Anillos incluidos - Кольца включены



G•STELLE MARINE



cod. 100
Bianco/Blu/Giallo
White/Blue/Yellow
Blanc/Bleu/Jaune
Weiss/Blau/Gelb
Blanco/Azul marino/Amarillo
Белый/Синий/Желтый

cm. 120 x 200 **C0112**
cm. 180 x 200 **C0118**
cm. 240 x 200 **C0124**

Anelli inclusi - Rings included
Anneaux fournis - Ringe inklusiv
Anillos incluidos - Кольца включены



G•MONOCROMO design Studio Affabre



cod. 110
Fucsia
Fuchsia
Fuchsia
Fuchsia
Fucsia
Фукия



cod. 111
Lilla
Lilac
Lilas
Lila
Fieder
Лила
Сирень



cod. 112
Verde acido
Acid green
Vert acide
Pfefferminz
Verde acido
Ярко-зелёный



cod. 113
Blu
Blue
Bleu
Blau
Azulón
Синий



cod. 114
Arancio
Orange
Orange
Orange
Aranjado
Оранжевый

cm. 120 x 200 **C0112**
cm. 180 x 200 **C0118**
cm. 240 x 200 **C0124**

Anelli inclusi - Rings included
Anneaux fournis - Ringe inklusiv
Anillos incluidos - Кольца включены

Tende doccia in TREVIRA CS

Trevira CS shower curtains
Rideaux de douche en Trevira CS
Duschvorhänge aus Trevira CS
Cortinas de baño en Trevira CS
Тревиры

Trevira CS - classe 1

Il tessuto ideale per alberghi e comunità. Alcuni decori delle tende in poliestere possono essere realizzati in Trevira CS per quantitativi minimi di 500 tende per decoro.

The ideal fabric for hotels and communities. Some patterns of the polyester shower curtains can be made of Trevira CS for minimum quantities of 500 curtains per patterns.

Le tissu idéal pour hôtels et communautés. Quelques dessins des rideaux en polyester peuvent être réalisés en Trevira CS pour des quantités de minimum 500 rideaux par dessin.

Der ideale Stoff für Hotel und Gemeinschaften. Einige Muster der Duschvorhänge aus Polyester können aus Trevira CS für Mindestmengen von 500 St. pro Muster hergestellt werden.

El material ideal para hoteles y comunidades. Algunos dibujos de las cortinas en poliéster se pueden realizar en Trevira CS, cantidad mínima 500 cortinas cada dibujo.

Идеальная ткань для гостиниц и общественных зданий. Некоторые рисунки, представленные моделями из полиэстера могут быть изготовлены из Тревиры в минимальном количестве 500 шт. каждого рисунка.

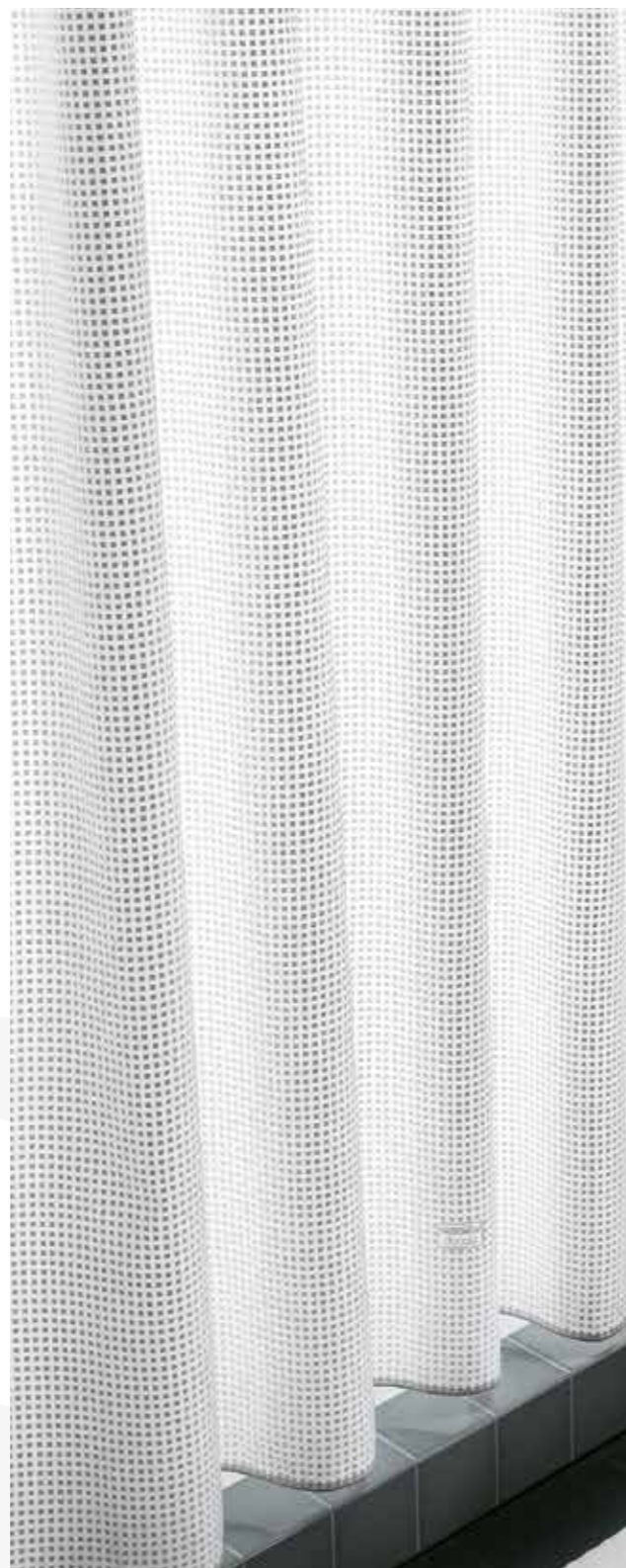

G•PIC NIC IGNIFUGA

design R. & S. Prodotto Gedy

 cod. 4039
Bianco/Bianco
White/White
Blanc/Blanc
Weiss/Weiss
Blanco/Blanco
Белый/Белый

cm. 120 x 200 **6712**
cm. 180 x 200 **6718**
cm. 240 x 200 **6724**

Tende doccia in VINILE

Le tende doccia in vinile Gedy sono realizzate in Italia con materiali di alta qualità e riciclabili al 100%. Il vinile è un materiale assolutamente eco compatibile, perfetto per le tende da doccia grazie alla sua morbidezza e resistenza. Gli occhielli sono elettrosaldati e rinforzati a doppio strato. La tenda è fornita completa di ganci. Ogni tenda è garantita 3 anni.

Les rideaux de douche en vinyle de Gedy sont fabriqués en Italie avec des matériaux de haute qualité et 100% recyclables. Le vinyle est un matériau totalement respectueux de l'environnement, idéal pour les rideaux de douche pour sa douceur et sa résistance. Les oeillets sont électrosoudés et renforcés à double couche. Le rideau de douche est livré avec anneaux. Chaque rideau est garantie pour 3 ans.

Las cortinas de vinilo Gedy están hechas en Italia con materiales de calidad 100% reciclables. El vinilo es un material absolutamente y ecológicamente racional, perfecto para las cortinas de ducha gracias a su suavidad y a su resistencia. Los ojetes están electrosoldados y reforzados con una doble capa. La cortina se suministra completa de ganchos.

Spessore - Thickness - Épaisseur
Stärke Espesor - Толщина 0,10

Gedy vinyl shower curtains are made in Italy, with high quality 100% recyclable materials. Vinyl is totally eco-friendly and thanks to its softness and endurance is perfect for shower curtains. The eyelets are electro-welded and double-layer reinforced. All curtains are supplied complete with hooks. Each shower curtain is 3 years guaranteed.

Gedy Vinyl-Duschvorhänge werden in Italien, mit hochwertigen und 100% wieder verwendbaren Materialien hergestellt. Vinyl ist ein absolut umweltfreundliches Material und dank seiner Weicheit und Widerstandsfähigkeit für Duschvorhänge ideal. Die Ösen sind elektrogeschweißt und doppellagig verstärkt. Alle Vorhänge werden komplett mit Haken geliefert. Jeder Duschvorhang hat eine 3 Jahre Garantie.

Занавески из ПВХ Gedy изготовлены в Италии из качественных 100% утилизируемых материалов. ПВХ представляет собой экологически устойчивый материал идеально подходящий для душевых занавесок благодаря своей прочности и мягкости. Отверстия для колец обработаны пластиком и усилены двойным загибом. К занавеске прилагаются крючки.



G•TINTA UNITA

cod. 129
 Bianco
 White
 Blanc
 Weiss
 Blanco
 Белый



cm. 120 x 200 **7112**
 cm. 180 x 200 **7118**
 cm. 240 x 200 **7124**

Anelli inclusi - Rings included
 Anneaux fournis - Ringe inklusiv
 Anillos incluidos - Кольца включены



G•ALGHE design Gabriele Vella

cod. 638
 Verde
 Green
 Vert
 Grün
 Verde
 Зелёный



cm. 120 x 200 **7112**
 cm. 180 x 200 **7118**
 cm. 240 x 200 **7124**

Anelli inclusi - Rings included
 Anneaux fournis - Ringe inklusiv
 Anillos incluidos - Кольца включены



G•ALTOMARE design Danilo Limoni

cod. 632
 Azzurro
 Light blue
 Bleu ciel
 Hellblau
 Azul celeste
 Голубой



cm. 120 x 200 **7112**
 cm. 180 x 200 **7118**
 cm. 240 x 200 **7124**

Anelli inclusi - Rings included
 Anneaux fournis - Ringe inklusiv
 Anillos incluidos - Кольца включены



G•BABY SOLE design Elisa Guberti

cod. 628
 Giallo
 Yellow
 Jaune
 Gelb
 Amarillo
 Желтый

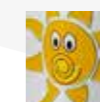

cm. 120 x 200 **7112**
 cm. 180 x 200 **7118**
 cm. 240 x 200 **7124**

Anelli inclusi - Rings included
 Anneaux fournis - Ringe inklusiv
 Anillos incluidos - Кольца включены



G• BUTTERFLY design Al-Over



cod. 578
Beige/Marrone
Beige/Brown
Beige/Marron
Beige/Braun
Champagne/Marrón
Бежвый/Коричневый цвет

cm. 120 x 200 **7112**
cm. 180 x 200 **7118**
cm. 240 x 200 **7124**

Anelli inclusi - Rings included
Anneaux fournis - Ringe inklusiv
Anillos incluidos - Кольца вклучены



G• FOGLIE STESE design Rita Lucci



cod. 629
Argento
Silver
Argent
Silber
Plata
Серебро

cm. 120 x 200 **7112**
cm. 180 x 200 **7118**
cm. 240 x 200 **7124**

Anelli inclusi - Rings included
Anneaux fournis - Ringe inklusiv
Anillos incluidos - Кольца вклучены



G• MEDITERRANEO design Carlo Sampietro



cod. 363
Blu
Blue
Bleu
Blau
Azul marino
Синий



cod. 364
Acquamarina
Aquamarine
Eau verte
Aquamarinblau
Aguamarina
Аквамарин



cod. 369
Champagne
Beige
Бежевый

cm. 120 x 200 **7112**
cm. 180 x 200 **7118**
cm. 240 x 200 **7124**

Anelli inclusi - Rings included
Anneaux fournis - Ringe inklusiv
Anillos incluidos - Кольца вклучены



G• MERLETTI design Carlo Sampietro



cod. 413
Azzurro
Light blue
Bleu ciel
Hellblau
Azul celeste
Голубой

cm. 120 x 200 **7112**
cm. 180 x 200 **7118**
cm. 240 x 200 **7124**

Anelli inclusi - Rings included
Anneaux fournis - Ringe inklusiv
Anillos incluidos - Кольца вклучены



G-OCEANICA design Carlo Sampietro



cod. 221
Azzurro/Blu
Light blue/Blue
Bleu ciel/Bleu
Hellblau/Blau
Azul celeste/Azul marino
Голубой/Синий

cm. 120 x 200 **7112**
cm. 180 x 200 **7118**
cm. 240 x 200 **7124**

Anelli inclusi - Rings included
Anneaux fournis - Ringe inklusiv
Anillos incluidos - Кольца вклучени



G-PENNELATA design Stefania Borioli



cod. 633
Blu
Blue
Bleu
Blau
Azulón
Синий

cm. 120 x 200 **7112**
cm. 180 x 200 **7118**
cm. 240 x 200 **7124**

Anelli inclusi - Rings included
Anneaux fournis - Ringe inklusiv
Anillos incluidos - Кольца вклучени



G-PIASTRELLINE design Jenny Frisone



cod. 627
Viola
Purple
Violet
Violett
Morado
Фиолетовый

cm. 120 x 200 **7112**
cm. 180 x 200 **7118**
cm. 240 x 200 **7124**

Anelli inclusi - Rings included
Anneaux fournis - Ringe inklusiv
Anillos incluidos - Кольца вклучени



G-RONDINI design Stefania Borioli



cod. 634
Grigio
Grey
Gris
Gru
Gris
Серый



cod. 635
Turchese
Turquoise
Turquoise
Türkis
Turquesa
Брюзовый
цвет



cod. 636
Arancio
Orange
Orange
Orange
Aranjado
Оранжевый



cod. 637
Verde acido
Acid green
Vert acide
Pfefferminz
Verde acido
Ярко-зелёный

cm. 120 x 200 **7112**
cm. 180 x 200 **7118**
cm. 240 x 200 **7124**

Anelli inclusi - Rings included
Anneaux fournis - Ringe inklusiv
Anillos incluidos - Кольца вклучени



G•SFUMATURE design Stefania Borioli



 cod. 631
 Bianco
 White
 Blanc
 Weiss
 Blanco
 белый

cm. 120 x 200 **7112**
 cm. 180 x 200 **7118**
 cm. 240 x 200 **7124**

Anelli inclusi - Rings included
 Anneaux fournis - Ringe inklusiv
 Anillos incluidos - Кольца вклучени





G•SPLASH design Sandra Bovolenta

 cod. 630
 Lilla
 Lilac
 Lilas
 Fieder
 Lila
 Сирень

cm. 120 x 200 **7112**
 cm. 180 x 200 **7118**
 cm. 240 x 200 **7124**

Anelli inclusi - Rings included
 Anneaux fournis - Ringe inklusiv
 Anillos incluidos - Кольца вклучени



G•ZODIACO design Faro design

 cod. 176
 Argento
 Silver
 Argent
 Silber
 Plata
 Сребро

cm. 120 x 200 **7112**
 cm. 180 x 200 **7118**
 cm. 240 x 200 **7124**

Anelli inclusi - Rings included
 Anneaux fournis - Ringe inklusiv
 Anillos incluidos - Кольца вклучени



Pieghella 90° e 180°

Decorì disponibili - Available patterns - Dessins disponibles - Lieferbare Muster - Decores disponibles
Возможные узоры

G•TINTA UNITA cod. 129



COD. 97900 (90°) - 97180 (180°)

Reggitenda pieghevole adatto per vasche da bagno e docce di tutte le misure: si apre a 90° e 180°. Il supporto con bracci d'acciaio è completato da tenda in vinile standard. Montaggio semplicissimo con quattro viti e tasselli a muro.

Fold-away shower rail and curtain opens to 90° or 180°. Wall support. Steel arms. Vinyl standard curtain, screws and wall plugs.

Cabine de douche pliable pour baignoires et douches de n'importe quelle dimension: s'ouvre à 90° et 180°. Le support avec bras en acier est complété par un rideau Standard en vinyl. Montage très simple avec quatre vis.

Duschschirm ausklappbar für Wannen und Duschen aller Grössen, zu öffnen auf 90° oder 180°. Wandbefestigung mit Armen aus Edelstahl komplett mit einem Vinyl Standard Vorhang nach Wahl. Montage einfachst mit beigefügten Schrauben und Dübeln.

Varillaje para bañeras y duchas, de todas las medidas: se abren a 90° y 180°. El soporte con brazos se completa con cortina en vinilo standard. Montage muy facil con 4 tornillos y tacos.

Раздвижной карниз и штора открывающаяся на 90° или 180°. Крепится на стене. Спицы из нержавеющей стали, стандартная занавеска из винила, винты и дюбеля.

Per quantitativi minimi di 50 pezzi è possibile confezionare la Pieghella con gli altri decori della collezione vinile Gedy.
Other patterns of Gedy vinyl collection available for Pieghella upon request for minimum 50 pcs.

Tende doccia in PVC

Le tende doccia in PVC Gedy sono realizzate con materiali di alta qualità. Il PVC è un materiale assolutamente, perfetto per le tende da doccia grazie alla sua morbidezza e resistenza. La tenda è fornita completa di ganci. Ogni tenda è garantita 3 anni.

Gedy PVC shower curtains are made with high quality materials. Thanks to its softness and endurance PVC is perfect for shower curtains. All curtains are supplied complete with hooks. Each shower curtain is 3 years guaranteed.

Les rideaux de douche en PVC de Gedy sont fabriqués avec des matériaux de haute qualité. Le PVC est un matériau idéal pour les rideaux de douche pour sa douceur et sa résistance. Le rideau de douche est livré avec anneaux. Chaque rideau est garanti pour 3 ans.

Gedy PVC-Duschvorhänge werden mit hochwertigen Materialien hergestellt. Dank seiner Weicheit und Widerstandsfähigkeit ist PVC ein ideales Material für Duschvorhänge. Alle Vorhänge werden komplett mit Haken geliefert. Jeder Duschvorhang hat eine 3 Jahre Garantie.

Las cortinas de PVC Gedy están hechas con materiales de calidad. El PVC es un material absolutamente, perfecto para las cortinas de ducha gracias a su suavidad y a su resistencia. La cortina se suministra completa de ganchos.

Занавески из PVC Gedy изготовлены из качественных материалов. PVC материал идеально подходящий для душевых занавесок благодаря своей прочности и мягкости. К занавеске прилагаются крючки.

Spessore - Thickness - Épaisseur
Stärke Espesor - Толщина 0,12



G•ELECTRA design Studio Affabre



cod. 212
Lilla
Lilac
Lilas
Fieder
Lila
Сирень



cod. 213
Verde
Green
Vert
Grün
Verde
Зелёный



cod. 214
Blu
Blue
Bleu
Blau
Azulón
Синий

cm. 120 x 200 **CO212**
cm. 180 x 200 **CO218**
cm. 240 x 200 **CO224**

Anelli inclusi - Rings included
Anneaux fournis - Ringe inklusiv
Anillos incluidos - Кольца включены



G•HEARTS design Carlo Sampietro

 cod. 202
 Giallo/Rosa/Rosso
 Yellow/Pink/Red
 Jaune/Rose/Rouge
 Gelb/Rosa/Rot
 Amarillo/Rosa/Rojo
 Желтый/Розовый/Красный

cm. 120 x 200 **CO212**
 cm. 180 x 200 **CO218**
 cm. 240 x 200 **CO224**

Anelli inclusi - Rings included
 Anneaux fournis - Ringe inklusiv
 Anillos incluidos - Кольца включены



G•HONEY FARM design Carlo Sampietro

 cod. 211
 Nero/Giallo
 Black/Yellow
 Noir/Jaune
 Schwarz/Gelb
 Negro/Amarillo
 Чёрный/Желтый

cm. 120 x 200 **CO212**
 cm. 180 x 200 **CO218**
 cm. 240 x 200 **CO224**

Anelli inclusi - Rings included
 Anneaux fournis - Ringe inklusiv
 Anillos incluidos - Кольца включены



G•MOSAICO



 cod. 200
 Azzurro/blu
 Light blue/Blue
 Bleu ciel/Bleu
 Hellblau/Blau
 Azul celeste/Azul marino
 Голубой/Синий

cm. 120 x 200 **CO212**
 cm. 180 x 200 **CO218**

Anelli inclusi - Rings included
 Anneaux fournis - Ringe inklusiv
 Anillos incluidos - Кольца включены



G•ONDE

 cod. 201
 Bianco su fondo trasparente
 White on a clear background
 Blanc sur fond transparent
 Weiss auf transparentem Untergrund
 Blanco sobre fondo transparente
 Белый на прозрачном фоне

cm. 120 x 200 **CO212**
 cm. 180 x 200 **CO218**
 cm. 240 x 200 **CO224**

Anelli inclusi - Rings included
 Anneaux fournis - Ringe inklusiv
 Anillos incluidos - Кольца включены



G•PAPAVERO design Carlo Sampietro

cod. 209
Rosa/Grigio
Pink/Grey
Rose/Gris
Rosa/Grau
Rosa/Gris
Розовый/сёрый

cm. 120 x 200 **C0212**
cm. 180 x 200 **C0218**
cm. 240 x 200 **C0224**

Anelli inclusi - Rings included
Anneaux fournis - Ringe inklusiv
Anillos incluidos - Кольца включены



G•ZOO design mabeindreams

cod. 215
Multicolore
Multicolour
Multicolore
Mehrfarbig
Multicolor
Многоцветный

cm. 120 x 200 **C0212**
cm. 180 x 200 **C0218**
cm. 240 x 200 **C0224**

Anelli inclusi - Rings included
Anneaux fournis - Ringe inklusiv
Anillos incluidos - Кольца включены

Tende doccia in PEVA

Le tende doccia in PEVA sono realizzate con materiali atossici e munite di occhielli elettrosaldati e rinforzati. La tenda viene fornita completa di ganci.

Les rideaux en PEVA sont fabriqués avec des matériaux atoxiques et ils sont munis d'œillets électrosoudés et renforcés. Le rideau est fourni avec ses anneaux.

Las cortinas de PEVA están hechas con materiales no tóxicos y están dotadas de ojete electrosoldados y reforzados. La cortina se suministra completa de ganchos.

PEVA curtains are made using non-toxic materials and fitted with electro-welded, reinforced eyelets. Curtains are supplied complete with hooks.

Die Vorhänge aus PEVA bestehen aus ungiftigen Materialien und sind mit elektrogewweißten und verstärkten Ösen versehen. Der Vorhang wird komplett mit Haken geliefert.

Занавески из ПВА (поливинилацетат) изготовлены из нетоксичных материалов с усиленными отверстиями, обработанными пластиком. К занавеске прилагаются крючки.

Spessore - Thickness - Épaisseur
Stärke Espesor - Толщина 0,09



G•FIJI

cod. 300
Azzurro/Bianco/Blu
Light blue/White/Blue
Bleu ciel/Blanc/Bleu
Hellblau/Weiss/Blau
Azul celeste/Bianco/Azul marino
Голубой/Белый/Синий

cm. 180 x 200 **C0318**

Anelli inclusi - Rings included
Anneaux fournis - Ringe inklusiv
Anillos incluidos - Кольца включены



G•FOGLIA



cod. 313
Verde
Green
Vert
Grün
Verde
Зелёный

cm. 180 x 200 **C0318**

Anelli inclusi - Rings included
Anneaux fournis - Ringe inklusiv
Anillos incluidos - Кольца вклучены



G•MY LOVE



cod. 306
Rosso/Nero
Red/Black
Rouge/Noir
Rot/Schwarz
Rojo/Negro
Красный/Чёрный

cm. 180 x 200 **C0318**

Anelli inclusi - Rings included
Anneaux fournis - Ringe inklusiv
Anillos incluidos - Кольца вклучены



G•PINGUINI



cod. 304
Bianco/Nero
White/Black
Blanc/Noir
Weiss/Schwarz
Blanco/Negro
Белый/Чёрный

cm. 180 x 200 **C0318**

Anelli inclusi - Rings included
Anneaux fournis - Ringe inklusiv
Anillos incluidos - Кольца вклучены



G•SWEETIE



cod. 312
Arancio
Orange
Orange
Orange
Aranjado
Оранжевый

cm. 180 x 200 **C0318**

Anelli inclusi - Rings included
Anneaux fournis - Ringe inklusiv
Anillos incluidos - Кольца вклучены

Anelli per tende doccia

Rings for shower curtains - Anneaux pour rideaux de douche
Vorhangsringe - Anillas para cortinas - Кольца для занавеса



9212-9216-92100

pz. 12 **9212**
pz. 16 **9216**
pz. 100 **92100**



00

Trasparente
Transparent
Лозрачным

02

Bianco
White
Blanc
Weiss
Blanco
Белый

Realizzati in resine termoplastiche

Made of thermoplastic resins

Réalisés en thermoplastique

Hergestellt aus Kunststoff

Realizados en resinas termoplásticas

Изготовлено из термопластичных смол



CO90 G • FIORE

3,7 x 5 x 7 cm

Realizzati in resine termoplastiche e metallo

Made of thermoplastic resins and metal

Réalisés en thermoplastique et métal

Hergestellt aus Kunststoff und Metall

Realizados en resinas termoplásticas y metal

Изготовлено из термопластичных смол и металла

Confezione da 12 pezzi
Pack of 12 pieces
Confection de 12 pièces
Box mit 12 Stücken
Confección 12 piezas
Пакет 12 частей

4X



90
Multicolore
Multicolor
Multicolore
Mehrfarbig
Multicolor
Многоцветный



Cavetto reggitenda e sostegno a soffitto per aste reggitenda

Shower curtain wire supporting cable and ceiling support for shower rails - Câble pour rideau de douche et support fixation plafond pour barre rideaux de douche - Duschvorhangseil und Deckenhalterung für Duschstangen - Cable cuelgacortinas y soporte de techo para barras para cortinas de ducha - Шнур для шторы и потолочная опора для палок для занавесок

13

Cromato
Chromed

9620

Realizzato in ottone e acciaio

Made of brass and steel

Réalisé en laiton et acier - Hergestellt aus Messing und Stahl

Realizado en latón y acero - Изготовленная из латуни и стали

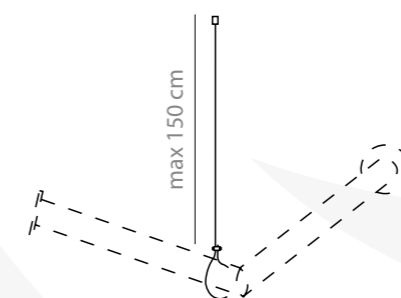
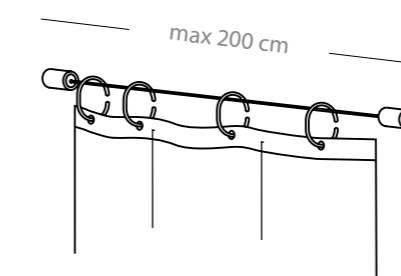

9200

ø 2,5 x h 60 cm

Realizzato in alluminio e resine termoplastiche

Made of aluminum and thermoplastic resins

Réalisé en aluminium et thermoplastique

Hergestellt aus Aluminium und Kunststoff

Realizado en aluminio y resinas termoplásticas

Изготовлено из алюминия и термопластичных смол

02

Bianco, laccatura epossidica
Epoxy lacquered white
Blanc, laquage epoxy
Epoxylack lackierter weiss
Blanco pintado epoxy
Белый, покрытый эпоксидным



13

Finitura spazzolata
Brushed finishing
Finition brossé
Gebürstete Ausfertigung
Acabado cepillado
Матовый алюминий



TELAJ REGGITENDA

Tutti i telai reggitenda Gedy sono realizzati in alluminio, materiale leggero e resistente che elimina il problema della ruggine. I tubi sono di generosa dimensione e concepiti per reggere anche le tende più pesanti. Sono disponibili numerosi kit che coprono tutte le necessità di composizione per vasca e doccia.

Tous les tubes pour les rideaux de douche de Gedy sont fabriqués en aluminium, un matériau léger et durable qui élimine le problème de la rouille.

Les tubes sont de grande taille et conçus pour résister à même de lourds rideaux. Il existe de nombreux kits qui couvrent tous les besoins de composition pour baignoire et douche.

Todos los tubos de soporte para las cortinas Gedy están hechos de aluminio, un material ligero y resistente que elimina el problema de la oxidación. Los tubos son de grandes dimensiones y están diseñados para soportar incluso el peso de las cortinas más pesadas. Están disponibles numerosos kits que satisfacen todas las necesidades de composición para bañera y ducha.

All Gedy shower curtain rods are made in aluminium, a lightweight and durable material which eliminates the rust problem. These rods have large sizes and hold even the heaviest curtains. Several kits are available to satisfy any kind of settlement for bath and shower.

Alle Gedy Duschstangen werden aus Aluminium, einem leichten und beständigen rostfreien Metall, gefertigt. Die Stangen sind derart dimensioniert und konzipiert, dass sie auch die schwersten Vorhänge halten. Zur Verfügung stehen zahlreiche Bausätze für alle möglichen Wannen- und Duschkompositionen.

Все трубы для занавесок Gedy изготовлены из алюминия, легкого и прочного материала, который не подвержен ржавчине. Размеры труб рассчитаны оптимально и смогут выдержать даже тяжелые шторы. В наличие имеется богатый ассортимент наборов для дополнения интерьера ванной и душа.

Realizzati in alluminio e resine termoplastiche - Made of aluminum and thermoplastic resins
Réalisés en aluminium et thermoplastique - Hergestellt aus Aluminium und Kunststoff
Realizados en aluminio y resinas termoplásticas - Изготовлено из алюминия и термопластичных смол

Spessore - Thickness - Épaisseur - Stärke
Espesor - Толщина mm. 0,5

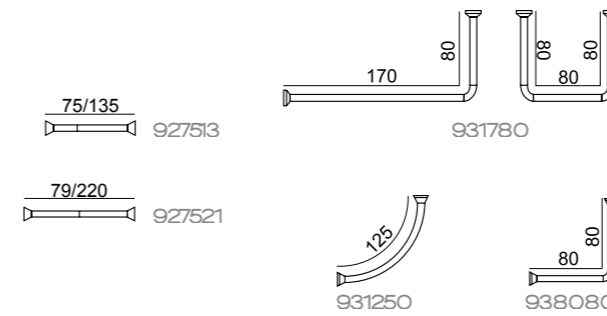

02
Bianco, laccatura epossidica
Epoxy lacquered white
Blanc, laquage epoxy
Epoxylack lackierter weiss
Blanco pintado epoxy
Белый, покрытый эпоксидным



13
Finitura spazzolata
Brushed finishing
Finition brossé
Gebürstete Ausfertigung
Acabado cepillado
Матовый алюминий



Spessore - Thickness - Épaisseur - Stärke
Espesor - Толщина mm. 0,5



02
Bianco, laccatura epossidica
Epoxy lacquered white
Blanc, laquage epoxy
Epoxylack lackierter weiss
Blanco pintado epoxy
Белый, покрытый эпоксидным



G•HAND

Le doccette Gedy sono presentate in una gamma ampia per design, numero di funzioni e prezzo.

Sono tutte dotate di filtro antisabbia, tettarelle che permettono una facile rimozione del calcare accumulatosi e di un filtro che permette la riduzione fino al 50% del consumo di acqua. Tutti gli attacchi sono nella misura universale standard 1/2".

Les douchettes Gedy sont présentées dans une vaste gamme subdivisée suivant le design, le nombre de fonctions et le prix. Elles sont toutes munies d'un filtre anti-sable, de pièces qui facilitent l'élimination du calcaire et d'un filtre qui permet de réduire jusqu'à 50% la consommation d'eau. Tous les raccords sont fournis dans la dimension universelle standard de 1/2 pouces.

Los mangos de ducha Gedy están disponibles en una amplia gama de modelos distintos por diseño, número de funciones y precio. Todos están dotados de filtro antiarena, eyectores que permiten una fácil remoción de la cal acumulada y de un filtro que permite reducir hasta el 50% el consumo de agua. Todas las conexiones son de tipo universal estándar de 1/2".

Gedy shower heads are available in a wide range of designs, function and prices.

All have sand filter, nipples for easy scale removal, and a filter to cut water consumption by up to 50%. All attachments are in the universal standard size of 1/2".

Die Handduschen Gedy werden hinsichtlich Design, Anzahl der Funktionen und Preis in einer großen Palette präsentiert. Alle ausgestattet mit Sandfilter, Einsatz für eine einfache Entfernung von Kalkablagerungen sowie Filter für die Verringerung des Wasserverbrauch um bis zu 50 %. Alle Anschlüsse mit den Standard-Universalmaßen 1/2".

Ручные души Gedy представлены в широком ассортименте по дизайну, количеству функций и стоимости. Все они оснащены фильтром для задержки песка, легко чистящимися от скопившейся накипи соплами и регулятором расхода, позволяющим сэкономить до 50% воды. Все соединения универсальные, отвечающие стандарту 1/2".

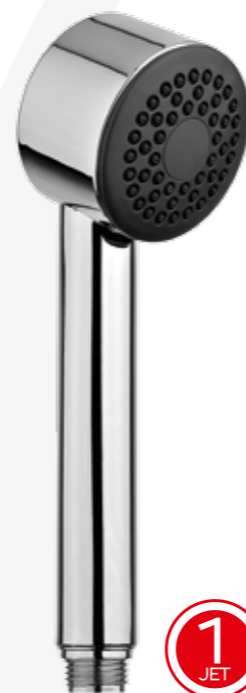

GSO1001

Ø 6,4 x 5,5 x 21,5 cm



GSO1002

Ø 6,5 x 4,5 x 20 cm



GSO1003

Ø 6,7 x 5 x 20 cm



GSO1004

Ø 9,4 x 4 x 22 cm



GSO1005

Ø 10 x 4,5 x 22,5 cm



GSO1006

Ø 10 x 4 x 24 cm



Conessione
UNIVERSALE
Universal
CONNECTION

col. 13
Cromato lucido
Chromed
Chrom
Cromado
Хром

Realizzate in ABS
Made of ABS
Réalisés en ABS
Hergestellt aus ABS
Realizados en ABS
Изготовлено из АБС пластик

Filtro Antisabbia
Sand filter
Filtre anti-sable
Sandschutzfilter
Filtro antirena
Универсальное крепление

Water Saving

Anticalcare
Anti-limestone
Anticalcaire
Kesselsteinlösemittel
Antical
Защита от известкового налета

Pioggia
Rain
Pluie
Regen
Lluvia
Дождик

Pioggia+Relax
Rain+Relax
Pluie+Détente
Regen+Relax
Lluvia+Relax
Дождик+Релакс

Morbido
Soft
Moelleux
Weich
Suave
Мягкая

Cascata
Cascade
Cascade
Wasserfall
Cascada
Водопад

Sottile
Thin
Fin
Leicht
Fino
Тонкая

Doppio relax
Double relax
Double détente
Doppleter Relax
Doble Relax
Супер релакс

Nebulizzato
Spray
Nébulisé
Zerstäubt
Nebulizado
Распыление

Acqua stop
Water stop
Arrêt eau
Wasserstopp
Agua stop
Пульсация



1
JET

GSO1007
Ø 9,5 x 4,5 x 25 cm



1
JET

GSO1008
Ø 4,5 x 2,5 x 22,8 cm



1
JET

GSO1009
Ø 3 x 22 cm



1
JET

GSO1013
Ø 12 x 5 x 28,5 cm



2
JETS

GSO1017
Ø 9,3 x 4,5 x 22,5 cm



3
JETS

GSO1016
Ø 7,9 x 5 x 22 cm



1
JET

GSO1010
Ø 3,5 x 1,8 x 24 cm



1
JET

GSO1011
Ø 15,8 x 6 x 26 cm



1
JET

GSO1012
Ø 15 x 6 x 24,5 cm



3
JETS

GSO1018
Ø 9,7 x 6,5 x 22,5 cm



3
JETS

GSO1019
Ø 12,3 x 6 x 23,5 cm



3
JETS

GSO1020
Ø 15 x 5,5 x 25 cm





3
JETS

GSO1021

Ø 14,3 x 4,5 x 24,5 cm



3
JETS

GSO1022

Ø 7,8 x 6 x 23,6 cm



3
JETS

GSO1023

Ø 8,3 x 6 x 23 cm



5
JETS

GSO1025

Ø 10 x 5 x 23 cm



5
JETS

GSO1026

Ø 10 x 5,5 x 23,5 cm



5
JETS

GSO1029

Ø 9,3 x 7,5 x 26 cm



3
JETS

GSO1027

Ø 12 x 5 x 24,5 cm



3
JETS

GSO1028

Ø 12 x 5 x 25 cm



5
JETS

GSO1024

Ø 9 x 8 x 24 cm



5
JETS

GSO1030

Ø 12 x 6,5 x 27 cm



5
JETS

GSO1031

Ø 12 x 5 x 25 cm



G·MINI SET

Alcune doccette della nostra gamma vengono presentate in una pratica confezione per il consumatore che include un flessibile in acciaio inox da cm.150 e un supporto a parete.

Certaines douchettes de notre gamme sont présentées dans un emballage pratique pour le consommateur, avec un tuyau flexible en acier inox de 150 cm et un support mural.

Igunos mangos de ducha de nuestra gama están contenidos dentro de una caja muy práctica para el consumidor que incluye un flexo de acero inoxidable de 150 cm y un soporte de pared.

Some shower heads in our range are sold in a practical package for the customer, which includes a 150 cm stainless steel hose plus a wall bracket.

Einige Handduschen unserer Produktpalette werden in einer praktischen Konfektion für den Verbraucher präsentiert, die einen Schlauch aus Edelstahl zu 150 cm sowie eine Wandhalterung umfasst.

Некоторые ручные души нашей коллекции представлены в виде практично упакованных комплектов, включающих шланг из нержавеющей стали на 150 см. и настенное крепление.



GSO3001



GSO3002



GSO3003



GSO3004



Connessione
UNIVERSALE
Universal
CONNECTION

col. 13
Cromato lucido
Chromed
Chrom
Cromado
Хром

Realizzati in ABS e acciaio inox
Made of ABS and stainless steel
Réalisés en ABS et acier inoxydable
Hergestellt aus ABS und Edelstahl
Realizados en ABS y acero inox
Изготовлено из АБС
и нержавеющей стали

Filtro Antisabbia
Sand filter
Filtre anti-sable
Sandschutzfilter
Filtro antirena
Универсальное крепление

Water Saving

Anticalcare
Anti-limestone
Anticalcaire
Kesselsteinlösemittel
Antical
Защита от известкового налета



Pioggia
Rain
Pluie
Regen
Lluvia
Дождик



Pioggia+Relax
Rain+Relax
Pluie+Détente
Regen+Relax
Lluvia+Relax
Дождик+Релакс



Morbido
Soft
Moelleux
Weich
Suave
Мягкая



Cascata
Cascade
Cascade
Wasserfall
Cascada
Водопад



Sottile
Thin
Fin
Leicht
Fino
Тонкая



Doppio relax
Double relax
Double détente
Doppleter Relax
Doble Relax
Супер релакс



Nebulizzato
Spray
Nébulisé
Zerstäubt
Nebulizado
Распыление

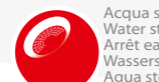

Acqua stop
Water stop
Arrêt eau
Wasserstopp
Agua stop
Пульсация



GSO3005



GSO3006



GSO3009



GSO3010



GSO3011



GSO3007



GSO3008



GSO3012



GSO3013



G·CHANGE

L'innovativa doccetta Gedy, anche in versione miniset, che include nella confezione anche un disco getti di ricambio, prolungando in misura significativa la durata nel tempo a prestazioni inalterate. Il disco può essere scelto in tre varianti colore: il classico celeste, il trendy lilla, il neutro bianco. Il disco di ricambio è invece sempre fornito in un grigio tecnico.

La douchette innovante Gedy, également dans la version miniset, fournie avec un disque pour jets de rechange, prolongeant de façon significative la qualité des prestations dans le temps.

Le disque est disponible en trois variantes de couleur : le bleu clair classique, le lilas trendy, le blanc neutre. Le disque de rechange est toujours fourni dans la couleur gris technique.

El innovador mango de ducha Gedy, también en versión miniset, que incluye dentro de la caja también un disco de chorros de repuesto, prolongando de manera significativa la duración en el tiempo con prestaciones inalteradas. El disco se puede elegir de tres colores distintos: el clásico celeste, el trendy lila, el neutro blanco. El disco de repuesto se suministra siempre de color gris técnico.

The cutting-edge Gedy shower head, now in miniset version, including a spare jet disc in the package, which significantly maintains performance standards over time. It is possible to choose from three disc colours: classical sky blue, trendy lilac, and neutral white. The spare, however, is always provided in technical grey.

Die innovative Handdusche Gedy, auch in der Version Miniset, die in der Konfektion auch eine Ersatz-Strahlscheibe enthält, wodurch die Lebensdauer bei unveränderten Leistungen beträchtlich verlängert wird. Die Scheibe kann in drei Farben ausgewählt werden: klassisches Himmelblau, trendige Lila und neutrales Weiß. Die Ersatzscheibe wird hingegen immer in technischem Grau geliefert.

Инновационный душ Gedy (в том числе мини-версия) комплектуется сменной насадкой, что значительно увеличивает эксплуатационный срок, не снижая его функциональности. Насадка представлена тремя вариациями цвета на выбор: классический голубой, модный сиреневый и нейтральный белый. Сменная насадка всегда поставляется в цветовом исполнении - серый технический.

Filtro Antisabbia
Sand filter
Filtre anti-sable
Sandschutzfilter
Filtro antirena
Универсальное крепление

Water Saving

Anticalcare
Anti-limestone
Anticalcaire
Kesselsteinlösemittel
Antical
Защита от известкового налета

Pioggia
Rain
Pluie
Regen
Lluvia
Дождик

Pioggia+Relax
Rain+Relax
Pluie+Détente
Regen+Relax
Lluvia+Relax
Дождик+Релакс

Doppio relax
Double relax
Double détente
Doppleter Relax
Doble Relax
Супер релакс

Conessione
UNIVERSALE
Universal
CONNECTION

Realizzate in ABS
Made of ABS
Réalisés en ABS
Hergestellt aus ABS
Realizados en ABS
Изготовлено из ABS пластика

col. 23
Cromato/bianco
Chromed/white
Chromé/blanc
Chrom/Weiss
Cromado/blanco
Хром/белый

col. 32
Cromato/lilla
Chromed/lilac
Chromé/lilas
Chrom/Fieder
Cromado/lila
Хром/сирень

col. 56
Cromato/azzurro
Chromed/light blue
Chromé/bleu ciel
Chrom/Hellblau
Cromado/celeste
Хром/голубой



GSO1032

Ø 10 x 5 x 25 cm



+ disco ricambio
+ replacement disc
+ disque de rechange
+ Ersatzscheibe
+ disco de recambio
+ сменная насадка



GSO3014



+ disco ricambio
+ replacement disc
+ disque de rechange
+ Ersatzscheibe
+ disco de recambio
+ сменная насадка



G·SLIDING BAR

A completamento della gamma doccette, Gedy propone anche la versione saliscendi, anche con interasse variabile del supporto a muro in modo da coprire fori a parete preesistenti, completa di flessibile in acciaio inox da cm.150 e di un porta sapone/porta oggetti. Disponibili anche una versione senza portasapone e la sola barra con saliscendi di ricambio.

Pour compléter la gamme des douchettes, Gedy propose également la version avec une barre de douche, munie d'un entraxe variable du support mural de manière à couvrir les trous préexistants dans le mur, et un tuyau flexible en acier inox de 150 cm et un porte-savon/porte-objets. On propose également une version sans porte-savon, comprenant uniquement la barre avec un dispositif de coulissement de rechange.

Para completar la gama de mangos de ducha, Gedy propone también la versión con soporte deslizante, también con distancia entre ejes variable del soporte de pared para tapar los agujeros ya existentes en la pared, completa de flexo de acero inoxidable de 150 cm y de una jabonera/porta-objetos. Disponible también una versión sin jabonera y solo la barra con soporte deslizante de repuesto.

To complete the range of shower heads, Gedy also offers the sliding bar version, with a variable fastening distance so as to cover existing holes in the wall and complete with 150 cm flexible hose and a soap/object dish. Also available without soap dish and with spare sliding bar.

Zur Vervollständigung der Handduschenpalette bietet Gedy auch die Version mit Wandschiene an, auch mit variablem Abstand der Wandhalterung zur Abdeckung der in der Wand vorhandenen Bohrungen, vollständig mit Schlauch aus Edelstahl zu 150 cm und Seifenhalter/Ablage. Auch verfügbar in einer Version ohne Seifenhalter und nur Ersatz-Wandschiene.

Для дополнения коллекции душей компания Gedy предлагает также исполнение со штангой, в том числе с подвижным настенным креплением, позволяющим скрыть существующие на стене отверстия, в комплекте со шлангом из нержавеющей стали на 150 см. и мыльницей/полочкой. Возможен вариант штанги со сменными держателями без мыльницы.

Conessione
UNIVERSALE
Universal
CONNECTION

col. 13
Cromato lucido
Chromé
Chrom
Cromado
Хром

Realizzati in ABS e acciaio inox
Made of ABS and stainless steel
Réalisés en ABS et acier inoxydable
Hergestellt aus ABS und Edelstahl
Realizados en ABS y acero inox
Изготовлено из ABS
и нержавеющей стали

Filtro Antisabbia
Sand filter
Filtre anti-sable
Sandschutzfilter
Filtro antirena
Универсальное крепление



Pioggia
Rain
Pluie
Regen
Lluvia
Дождик



Morbido
Soft
Moelleux
Weich
Suave
Мягкая

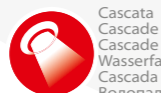

Cascata
Cascade
Cascade
Wasserfall
Cascada
Водопад



Sottile
Thin
Fin
Leicht
Fino
Тонкая



Doppio relax
Double relax
Double détente
Doppleter Relax
Doble Relax
Супер релакс



Nebulizzato
Spray
Nébulisé
Zerstäubt
Nebulizado
Распыление



Acqua stop
Water stop
Arrêt eau
Wasserstopp
Agua stop
Пульсация



1
JET

GSO2007



ø 22



2
JETS

GSO2004



interasse variabile - Adjustable distance - Distance variable
Höhenverstellbares Abstand - Перульичное межосевое расстояние



3
JETS

GSO2005



interasse variabile - Adjustable distance - Distance variable
Höhenverstellbares Abstand - Перульичное межосевое расстояние

G • SHOWER HEAD

Largo ventaglio di misure, funzioni, forme e materiali per i soffioni doccia Gedy, tutti dotati di filtro antisabbia, tecnologia water saving, tettarelle che permettono una rapida rimozione manuale del calcare.

Wide range of size, functions, shapes and materials for Gedy shower heads, all with sand filter, water saving technology and nipples for easy scale removal by hand.

Vaste gamme de dimensions, de fonctions, de formes et de matériaux pour les pommes de douche Gedy, toutes munies d'un filtre anti-sable, suivant la technologie water saving, des picots qui permettent une élimination manuelle rapide du calcaire.

Große Vielfalt von Größen, Funktionen, Formen und Materialien für die Duschstrahler Gedy, alle ausgestattet mit Sandfilter, Water-Saving-Technologie und Einsatz für die schnelle Entfernung von Kalkablagerungen.

Amplio abanico de medidas, funciones, formas y materiales para los rociadores ducha Gedy, todos dotados de filtro anti-arena, tecnología para el ahorro de energía, eyectores que permiten una rápida remoción manual de la cal.

Ассортимент леек Gedy представлен богатым выбором размеров, функций, форм и материалов. Все они оснащены фильтром для задержки песка, регулятором расхода воды и легко чистящимися от скопившейся накипи соплами.



GSO2002



GSO2001



GSO2003



Höhenverstellbares Abstand - Distance variable - Регулируемое межсоединение



GSO2008

Ø 2,2 x 50 cm

GSO2006

Ø 2,2 x 50 cm

Filtro Antisabbia
Sand filter
Filtre anti-sable
Sandschutzfilter
Filtro antirena
Универсальное крепление

Water Saving

Anticalcare
Anti-limestone
Anticalcaire
Kesselsteinlösemittel
Antical
Защита от известкового налета

Pioggia
Rain
Pluie
Regen
Lluvia
Дождик

Morbido
Soft
Moelleux
Weich
Suave
Мягкая

Sottile
Thin
Fin
Leicht
Fino
Тонкая

Doppio relax
Double relax
Double détente
Doppleter Relax
Doble Relax
Супер релакс

Nebulizzato
Spray
Nébulisé
Zerstäubt
Nebulizado
Распыление

Connessione
UNIVERSALE

Universal
CONNECTION

col. 13
Cromato lucido
Chromé
Chrom
Cromado
Хром

GSO4005

Ø 7 x 10 cm

col. 13
Cromato
Chromed
Chromé
Chrom
Cromado
Хром



Realizzato in ABS - Made of ABS
Réalisé en ABS - Hergestellt aus ABS
Realizado en ABS - Изготовлено из АБС пластик

GSO4006

Ø 6,5 x 8,4 cm

col. 13
Cromato
Chromed
Chromé
Chrom
Cromado
Хром



Realizzato in ABS - Made of ABS
Réalisé en ABS - Hergestellt aus ABS
Realizado en ABS - Изготовлено из АБС пластик

GSO4011

Ø 20 x 20 x 6,5 cm

col. 13
Cromato
Chromed
Chromé
Chrom
Cromado
Хром



Realizzato in ottone - Made of brass
Réalisé en laiton - Hergestellt aus Messing
Realizado en latón - Изготовлено из латуни

GSO4012

14,5 x 20 x 6 cm

col. 13
Cromato
Chromed
Chromé
Chrom
Cromado
Хром



Realizzato in ottone - Made of brass
Réalisé en laiton - Hergestellt aus Messing
Realizado en latón - Изготовлено из латуни

GSO4007

Ø 8 x 8 cm

col. 13
Cromato
Chromed
Chromé
Chrom
Cromado
Хром



Realizzato in ABS - Made of ABS
Réalisé en ABS - Hergestellt aus ABS
Realizado en ABS - Изготовлено из АБС пластик

GSO4008

Ø 7,3 x 9,7 cm

col. 13
Cromato
Chromed
Chromé
Chrom
Cromado
Хром



Realizzato in ABS - Made of ABS
Réalisé en ABS - Hergestellt aus ABS
Realizado en ABS - Изготовлено из АБС пластик

GSO4014

Ø 25 x 6 cm

col. 38
Acciaio spazzolato
Brushed steel
Acier brossé
Edelstah gebürstet
Acero cepillado
Шлифованная сталь



Realizzato in acciaio inox
Made of stainless steel
Réalisé en acier inoxydable - Hergestellt aus Edelstahl
Realizado en acero inox - Изготовлено из нержавеющей сталь

GSO4015

25 x 25 x 6,5 cm

col. 38
Acciaio spazzolato
Brushed steel
Acier brossé
Edelstah gebürstet
Acero cepillado
Шлифованная сталь



Realizzato in acciaio inox
Made of stainless steel
Réalisé en acier inoxydable - Hergestellt aus Edelstahl
Realizado en acero inox - Изготовлено из нержавеющей сталь

GSO4009

Ø 10 x 6,5 cm

col. 13
Cromato
Chromed
Chromé
Chrom
Cromado
Хром



Realizzato in ABS - Made of ABS
Réalisé en ABS - Hergestellt aus ABS
Realizado en ABS - Изготовлено из АБС пластик

GSO4016

Ø 20 x 8 cm

col. 13
Cromato
Chromed
Chromé
Chrom
Cromado
Хром



Realizzato in ABS - Made of ABS
Réalisé en ABS - Hergestellt aus ABS
Realizado en ABS - Изготовлено из АБС пластик

GSO4017

Ø 8,4 x 11,5 cm

col. 13
Cromato
Chromed
Chromé
Chrom
Cromado
Хром



Realizzato in ABS - Made of ABS
Réalisé en ABS - Hergestellt aus ABS
Realizado en ABS - Изготовлено из АБС пластик

GSO4018

Ø 9,8 x 8,9 cm

col. 13
Cromato
Chromed
Chromé
Chrom
Cromado
Хром



Realizzati in ABS - Made of ABS
Réalisés en ABS - Hergestellt aus ABS
Realizados en ABS - Изготовлено из АБС пластик

GSO4013

19 x 25,5 x 7 cm

col. 13
Cromato
Chromed
Chromé
Chrom
Cromado
Хром



Realizzato in ABS - Made of ABS
Réalisé en ABS - Hergestellt aus ABS
Realizado en ABS - Изготовлено из АБС пластик

GSO4010

Ø 20 x 11,5 cm

col. 13
Cromato
Chromed
Chromé
Chrom
Cromado
Хром



Realizzato in ottone - Made of brass
Réalisé en laiton - Hergestellt aus Messing
Realizado en latón - Изготовлено из латуни

GSO4019

Ø 10 x 8,5 cm

col. 13
Cromato
Chromed
Chromé
Chrom
Cromado
Хром



Realizzato in ABS - Made of ABS
Réalisé en ABS - Hergestellt aus ABS
Realizado en ABS - Изготовлено из АБС пластик

GSO4020

Ø 9,3 x 10,7 cm

col. 13
Cromato
Chromed
Chromé
Chrom
Cromado
Хром



Realizzato in ABS - Made of ABS
Réalisé en ABS - Hergestellt aus ABS
Realizado en ABS - Изготовлено из АБС пластик

G•LED

Dotati di un controllo temperatura a colori intuitivo (azzurro= acqua fredda, verde= temperatura ottimale, rosso= temperatura eccessiva), le doccette e i soffioni a LED di Gedy sono equipaggiati di una dinamo al loro interno che sfrutta il movimento dell'acqua per illuminare i LED. Nel caso degli areatori l'alimentazione è a batteria, inclusa nella confezione.

Munies d'un dispositif de contrôle de la température couleurs intuitif (bleu clair= eau froide, vert= température optimale, rouge = température excessive), les douchettes et les pommes de douche à LEDs de Gedy sont équipées d'une dynamo interne qui exploite le mouvement de l'eau pour allumer les LEDs. Les aérateurs prévoient une alimentation des LEDS avec une pile présente dans l'emballage.

Dotados de un control temperatura de colores intuitivo (azul= agua fría, verde= temperatura óptima, rojo= temperatura excesiva), los mangos de ducha y los rociadores de LED de Gedy en su interior están equipados con una dinamo que aprovecha el movimiento del agua para iluminar los LEDs. En el caso de los aireadores la alimentación led se consigue con una batería, incluida en la caja.

With an intuitive colour temperature control (light blue= cold water, green=optimum temperature, red= too hot), the LED shower head from Gedy have a dynamo fitted inside that uses the movement of the water to switch on the LED. With aerator heads, the dynamo is battery operated and included in the package.

Ausgestattet mit einer Temperaturkontrolle mit intuitiven Farben (hellblau = kaltes Wasser, grün = optimale Temperatur, rot = zu hohe Temperatur), die Handduschen und die LED-Ausstrahler von Gedy sind ausgestattet mit einem internen Dynamo, der die Bewegung des Wasser zur Speisung der LEDs nutzt. Bei den Lüftern erfolgt die Stromversorgung über Batterie, in der Konfektion enthalten.

Светодиодные души и лейки Gedy со встроенным генератором для питания светодиодов за счет движения воды изменяют цвет в зависимости от температуры воды (голубой – холодная, зеленый – оптимальная, красный –чрезмерная). При наличии аэраторов для питания светодиодов используется батарейка, входящая в комплект.

Filtro Antisabbia
Sand filter
Filtre anti-sable
Sandschutzfilter
Filtro antirena
Универсальное крепление



Pioggia
Rain
Pluie
Regen
Lluvia
Дождик



Sottile
Thin
Fin
Leicht
Fino
Тонкая

col. 13
Cromato lucido
Chromed
Chromé
Chrom
Cromado
Хром

Realizzati in ABS
Made of ABS
Réalisés en ABS
Hergestellt aus ABS
Realizados en ABS
Изготовлено из АБС пластик

Conessione
UNIVERSALE
Universal
CONNECTION



Water Saving

Anticalcare
Anti-limestone
Anticalcaire
Kesselsteinlösemittel
Antical
Защита от известкового налета



GSO1033

Ø 7,5 x 6 x 23 cm



GSO1034

Ø 7,5 x 6 x 20,5 cm



GSO1035

Ø 10,2 x 6 x 23,5 cm



GSO4003

Ø 5,2 x 11 cm



GSO4004

Ø 6,5 x 11 cm



Soffione a 1 funzione e controllo Led di temperatura a batteria (inclusa)
Single-function LED shower head with LED temperature control batterie (included)
Pomme de douche LED à 1 fonction et contrôle led de température batterie (fournis)
Kopfbrause LED mit 1 Funktion und Temperaturkontrolle Batterien (inklusive)
Cabezal ducha LED de 1 función y control led de temperatura batería (incluida)
Светодиодный пейка (1 функция) с изменением цвета в зависимости от температуры

Soffione a 1 funzione e controllo Led di temperatura a batteria (inclusa)
Single-function LED shower head with LED temperature control batterie (included)
Pomme de douche LED à 1 fonction et contrôle led de température batterie (fournis)
Kopfbrause LED mit 1 Funktion und Temperaturkontrolle Batterien (inklusive)
Cabezal ducha LED de 1 función y control led de temperatura batería (incluida)
Светодиодный пейка (1 функция) с изменением цвета в зависимости от температуры

GSO4001

Ø 3,5 x 6 cm



GSO4002

Ø 3 x 5 cm



Aeratore a 1 funzione e controllo Led di temperatura a batteria (inclusa)
Single-function LED aerator head with LED temperature control batterie (included)
Aérateur LED à 1 fonction et contrôle led de température batterie (fournis)
Lüfter LED mit 1 Funktion und Temperaturkontrolle Batterien (inklusive)
Aireador LED de 1 función y control led de temperatura batería (incluida)
Аэратор (1 функция) с изменением цвета в зависимости от температуры

Aeratore a 1 funzione e controllo Led di temperatura a batteria (inclusa)
Single-function LED aerator head with LED temperature control batterie (included)
Aérateur LED à 1 fonction et contrôle led de température batterie (fournis)
Lüfter LED mit 1 Funktion und Temperaturkontrolle Batterien (inklusive)
Aireador LED de 1 función y control led de temperatura batería (incluida)
Аэратор (1 функция) с изменением цвета в зависимости от температуры

G·FLEX

ø1,4

Tutti dotati di attacco universale 1/2" e di doppia aggraffatura, i flessibili Gedy sono presentati in un ampio ventaglio di materiali, finiture e misure disponibili.

Tous munis d'un raccord universel de 1/2 pouces et d'un double agrafage, les tuyaux flexibles Gedy sont présentés dans une vaste gamme de matériaux, de finitions et de dimensions.

Todos dotados de conexión universal 1/2" y de engrapado doble, los flexos Gedy están disponibles con un amplio abanico de materiales, acabados y medidas.

All complete with universal 1/2" fitting and dual crimping. Gedy hoses are available in a wide range of materials, finishes and sizes.

Alle ausgestattet mit Universalanschluss 1/2" und doppelter Rändelung: die Schläuche Gedy werden in einer Vielzahl von Materialien, Verarbeitungen und Größen angeboten.

Все шланги Gedy в двойной оплетке и имеют универсальное соединение 1 / 2", в наличии большой выбор материалов, отделок и размеров.

CON MECCANISMO ANTITORSIONE - WITH ANTI-TWIST MECHANISM
AVEC MÉCANISME ANTI-TORSION - MIT ANTI-DREHMECHANIK
CON MECANISMO ANTI-TORSIÓN - С МЕХАНИЗМОМ АНТИ-ТВИСТ

GS09001
ø 2,2 x 120 cm

GS09002
ø 2,2 x 150 cm

GS09003
ø 2,2 x 175 cm

GS09004
ø 2,2 x 200 cm



col. 13
Cromato
Chromed
Chromé
Chrom
Cromado
Хром

Acciaio inox/attacchi in ottone
Stainless steel/brass nuts
Acier inox/écrous en laiton
Rostfreier Stahl/Nüsse aus Messing
Acero inoxidable/tuercas en latón
нержавеющая сталь/латунные гайки

GS09005
ø 2,2 x 120 cm

GS09006
ø 2,2 x 150 cm

GS09007
ø 2,2 x 175 cm

GS09008
ø 2,2 x 200 cm



col. 13
Finitura lucida
Polished
Brillant
Polierter
Brillo
Хром

Acciaio inox/attacchi in ottone
Stainless steel/brass nuts
Acier inox/écrous en laiton
Rostfreier Stahl/Nüsse aus Messing
Acero inoxidable/tuercas en latón
нержавеющая сталь/латунные гайки

GS09026
ø 2,2 x 120 cm

GS09027
ø 2,2 x 150 cm

GS09028
ø 2,2 x 175 cm

GS09029
ø 2,2 x 200 cm

col. 23
Bianco/cromo
White/chrome
Blanc/chromé
Weiss/Chrom
Blanco/cromado
Белый /Хром



Nylon/attacchi in ottone
Nylon/brass nuts
Nylon/écrous en laiton
Nylon/Nüsse aus Messing
Nylon/tuercas en latón
Нейлон/латунные гайки

GS09030
ø 2,2 x 120 cm

GS09031
ø 2,2 x 150 cm

GS09032
ø 2,2 x 175 cm

GS09033
ø 2,2 x 200 cm

col. 73
Argento lucido
Silver
Argent
Silber
Plata
Серебро



PVC/attacchi in ottone
PVC/brass nuts
PVC/écrous en laiton
PVC/Nüsse aus Messing
PVC/tuercas en latón
ПВХ/латунные гайки

GS09010
ø 2,2 x 120 cm

GS09011
ø 2,2 x 150 cm

GS09012
ø 2,2 x 175 cm

GS09013
ø 2,2 x 200 cm



col. 15
Rame
Copper
Cuivre
Kupfer
Cobre
Медь

Acciaio inox/attacchi in ottone
Stainless steel/brass nuts
Acier inox/écrous en laiton
Rostfreier Stahl/Nüsse aus Messing
Acero inoxidable/tuercas en latón
нержавеющая сталь/латунные гайки

GS09014
ø 2,2 x 120 cm

GS09015
ø 2,2 x 150 cm

GS09016
ø 2,2 x 175 cm

GS09017
ø 2,2 x 200 cm



col. 44
Bronzo
Bronze
Bronze
Bronze
Bronze
Бронза

Acciaio inox/attacchi in ottone
Stainless steel/brass nuts
Acier inox/écrous en laiton
Rostfreier Stahl/Nüsse aus Messing
Acero inoxidable/tuercas en latón
нержавеющая сталь/латунные гайки

GS09042
ø 2,2 x 120 cm

GS09043
ø 2,2 x 150 cm

GS09044
ø 2,2 x 175 cm

GS09045
ø 2,2 x 200 cm



col. 73
Argento satinato
Silver
Argent
Silber
Plata
Серебро

ø1,5

PVC/attacchi in ottone
PVC/brass nuts
PVC/écrous en laiton
PVC/Nüsse aus Messing
PVC/tuercas en latón
ПВХ/латунные гайки

GS09046
ø 2,2 x 120 cm

GS09047
ø 2,2 x 150 cm

GS09048
ø 2,2 x 175 cm

GS09049
ø 2,2 x 200 cm



col. 13
Cromo lucido
Chromed
Chromé
Chrom
Cromado
Хром

ø1,5

PVC/attacchi in ABS
PVC/ABS nuts
PVC/écrous en ABS
PVC/Nüsse aus ABS
PVC/tuercas en ABS
ПВХ/АБС гайки

ESTENSIBILE - EXTENSIBLE - EXTENSIBLE
ERWEITERBAR - EXTENSIBLE - РАСТЯЖИМЫЙ

GS09018
ø 2,2 x 120 cm

GS09019
ø 2,2 x 150 cm

GS09020
ø 2,2 x 175 cm

GS09021
ø 2,2 x 200 cm



col. 87
Oro
Gold
Or
Gold
Oro
Золото

Acciaio inox/attacchi in ottone
Stainless steel/brass nuts
Acier inox/écrous en laiton
Rostfreier Stahl/Nüsse aus Messing
Acero inoxidable/tuercas en latón
нержавеющая сталь/латунные гайки

GS09022
ø 2,2 x 120 cm

GS09023
ø 2,2 x 150 cm

GS09024
ø 2,2 x 175 cm

GS09025
ø 2,2 x 200 cm



col. 43
Nero/cromo
Black/chromed
Noir/chromé
Schwarz/Chrom
Negro/cromado
Чернота/Хром

Nylon/attacchi in ottone
Nylon/brass nuts
Nylon/écrous en laiton
Nylon/Nüsse aus Messing
Nylon/tuercas en latón
Нейлон/латунные гайки

G•SHOWER PANEL

A lato dei moderni pannelli in acciaio inox in finitura spazzolata, Gedy presenta anche una collezione di pannelli doccia multifunzione in vetro temperato ultralight laccato in colorazioni abbinabili con la sua enorme gamma di accessori e complementi per il bagno.

Outre les panneaux modernes en acier inox dans la finition brossée, Gedy présente une collection de panneaux de douche multifonction en verre trempé ultralight laqué dans des couleurs à assortir à sa gamme considérable d'accessoires et d'éléments de décoration pour la salle de bains.

Además de los modernos paneles de acero inoxidable con acabado cepillado, Gedy presenta también una colección de paneles ducha multifunción de vidrio templado ultralight lacado en colores combinables con su enorme gama de accesorios y complementos para el baño.

Alongside the modern panels in stainless steel with brushed finish, Gedy also has a collection of multipurpose shower panels in ultralight tempered glass, which combine with its enormous range of accessories and complementary features for the bathroom.

Neben den moderne Paneelen aus gebürstetem Edelstahl bietet Gedy auch eine Kollektion von Multifunktionsduschpaneelen aus utraleichem gehärtetem Glas an, lackiert in Farben, die mit der enormen Palette der Accessoires für das Bad kombiniert werden kann.

Наряду с душевыми панелями из нержавеющей стали с отделкой «эффект щетки» Gedy представляет также коллекцию душевых многофункциональных панелей из суперлегкого закаленного стекла, покрытого цветным лаком, который можно сочетать с множеством аксессуаров и дополнений для ванн.

-  Poggia
Rain
Pluie
Regen
Lluvia
Дождик
-  Idromassaggio
Massage jet
Jet de massage
Massagestrahl
Chorro masaje
массажная струя
-  Morbido
Soft
Moelleux
Weich
Suave
Мягкая
-  Doppio relax
Double relax
Double détente
Doppleter Relax
Doble Relax
Супер релакс

GSO6003

18 x 158,5 cm

col. 38
Acciaio spazzolato
Brushed steel
Acier brossé
Edelstahl gebürstet
Acero cepillado
Шлифованная сталь



6 getti di massaggio
6 massage jets
6 jets de massage
6 Massagestrahlen
6 chorros masaje
6 массажными струями



Realizzato in acciaio inox, ottone e ABS
Made of stainless steel, brass and ABS
Réalisé en acier inoxydable, laiton et ABS
Hergestellt aus Edelstahl, Messing und ABS
Realizado en acero inox, latón y ABS
Изготовлено из нержавеющей стали, латуни и ABS

foto da sistemare la curvatura

GSO6004

18 x 158 cm

col. 38
Acciaio spazzolato
Brushed steel
Acier brossé
Edelstahl gebürstet
Acero cepillado
Шлифованная сталь



2 getti di massaggio
2 massage jets
2 jets de massage
2 Massagestrahlen
2 chorros masaje
2 массажными струями



Realizzato in acciaio inox, ottone e ABS
Made of stainless steel, brass and ABS
Réalisé en acier inoxydable, laiton et ABS
Hergestellt aus Edelstahl, Messing und ABS
Realizado en acero inox, latón y ABS
Изготовлено из нержавеющей стали, латуни и ABS

G•SHOWER COLUMN

GS06001

20,3 x 130 cm



Vetro temperato
Tempered glass
Verre tempéré
Sekuritglas
Cristal templado
закаленного стекла

col. 02
Bianco
White
Blanc
Weiss
Blanco
белый

col. 05
Blu
Blue
Bleu
Blau
Azulón
Синий

col. 73
Argento
Silver
Argent
Silber
Plata
серебро

col. 79
Lilla
Lilac
Lilas
Flieder
Lila
Сирень

Acciaio inox
Stainless steel
Acier inox
Edelstahl
Acero inoxidable
Нержавеющая сталь

col. 38
Acciaio spazzolato
Brushed steel
Acier brossé
Edelstahl gebürstet
Acero cepillado
Шлифованная сталь

1 getto di massaggio
1 massage jet
1 jet de massage
1 Massagestrahl
1 chorro masaje
1 массажная струя

Realizzati in acciaio inox, vetro temperato, ottone e ABS
Made of stainless steel, tempered glass, brass and ABS
Réalisés en acier inoxydable, verre tempéré, laiton et ABS
Hergestellt aus Edelstahl, Sekuritglas, Messing und ABS
Realizados en acero inox, cristal templado, latón y ABS
Изготовлено из нержавеющей стали, закаленного стекла, латуни и ABS

GS06002

22,8 x 154 cm

col. 38
Acciaio spazzolato
Brushed steel
Acier brossé
Edelstahl gebürstet
Acero cepillado
Шлифованная сталь



2 getti di massaggio
2 massage jets
2 jets de massage
2 Massagestrahlen
2 chorros masaje
2 массажными струями

Realizzato in acciaio inox, ottone e ABS
Made of stainless steel, brass and ABS
Réalisé en acier inoxydable, laiton et ABS
Hergestellt aus Edelstahl, Messing und ABS
Realizado en acero inox, latón y ABS
Изготовлено из нержавеющей стали, латуни и ABS

Una gamma compatta che va incontro a tutti i gusti e alle funzioni richieste nella doccia, racchiuse in un solo articolo compatto e dalle giuste proporzioni. Tutte le colonne sono regolabili in altezza per il massimo comfort nella doccia per tutti i membri della famiglia.

Une gamme compacte qui satisfait tous les goûts et les fonctions d'une douche, réunies en un seul article compact et bien proportionné. Toutes les colonnes sont réglables en hauteur assurant le plus grand confort à l'intérieur de la douche à tous les membres de la famille.

Una gama compacta que satisface todos los gustos y las funciones requeridas para la ducha, unidas en un sólo artículo compacto y de proporciones adecuadas. Todas las barras para la ducha son regulables en altura para el máximo confort en la ducha de todos los miembros de la familia.

A compact range to satisfy all tastes and all of the functions required of a shower, in a single, compact and perfectly sized item. All columns are height adjustable for maximum shower comfort for all members of the family.

Eine kompakte, trendige Produktpalette, die alle Funktionen einer Dusche erfüllt, und dies in einem einzigen kompakten Artikel mit den richtigen Proportionen. Alle Duschsäulen sind höhenverstellbar, um allen Mitgliedern der Familie in der Dusche den optimalen Komfort zu bieten.

Эта компактная линейка душей отвечает всем требованиям и вкусам, объединенными в одном предмете оптимальных размеров. Все души-колонны регулируются по высоте, что обеспечивает максимальный комфорт в душе для всех членов семьи.

Filtro Antisabbia
Sand filter
Filtre anti-sable
Sandschutzfilter
Filtro antirena
Универсальное крепление

Anticalcare
Anti-limestone
Anticalcaire
Kesselsteinlösemittel
Antical
Защита от известкового налета



Pioggia
Rain
Pluie
Regen
Lluvia
Дождик



Sottile
Thin
Fin
Leicht
Fino
Тонкая



Doppio relax
Double relax
Double détente
Doppleter Relax
Doble Relax
Супер релакс

Connessione
UNIVERSALE
Universal
CONNECTION

Realizzati in acciaio inox, ottone e ABS
Made of stainless steel, brass and ABS
Réalisés en acier inoxydable, laiton et ABS
Hergestellt aus Edelstahl, Messing und ABS
Realizados en acero inox, latón y ABS
Изготовлено из нержавеющей стали, латуни и ABS

GS05004
50 x 90/144 cm

1
JET



ø 20,5

90/144 cm

col. 13
Cromato lucido
Chromed
Chromé
Chrom
Cromado
Хром

GS05005
47,5 x 85/139 cm

3
JETS



ø 23

85/139 cm

col. 13
Cromato lucido
Chromed
Chromé
Chrom
Cromado
Хром

GS05006
50 x 81/122 cm

1
JET



ø 24

81/122 cm

col. 81
Cromato/verde
Chromed/green
Chromé/vert
Chrom/Grün
Cromado/verde
Хром/Зелёный

GS05003
49 x 85/139 cm

3
JETS



ø 24

85/139 cm

col. 13
Cromato lucido
Chromed
Chromé
Chrom
Cromado
Хром

G·MINIFLEX

GS05001
47,5 x 85/139 cm



col. 13
Cromato lucido
Chromed
Chromé
Chrom
Cromado
Хром

GS05002
47 x 85/139 cm



col. 13
Cromato lucido
Chromed
Chromé
Chrom
Cromado
Хром

Gamma compatta ma completa di aeratori e cannuce aeratore con connessione universale e 2 getti.

Gamme compacte mais complète d'accessoires avec des aérateurs et des tubes d'aérateur munis d'une connexion universelle et de 2 jets.

Gama compacta pero completa de aireadores y tubos aireador con conexión universal y 2 chorros.

A compact yet full range of aerator heads and pipe aerators with universal connection and 2 jets.

Kompakte Produktpalette, jedoch komplett mit Lüftern und Lüfterröhre mit Universalanschluss und zwei Strahlen.

Небольшой, но полный ассортимент аэраторов и распылительный трубок с универсальный соединением на две струи.



Pioggia
Rain
Pluie
Regen
Lluvia
Дождик



Candela
Candle
Jet droit
Kerzenförmiger Strahl
Chorro en forma de vela
Турбо-струя

Connessione
UNIVERSALE
Universal
CONNECTION

GS07001

Ø 3,2 x 6 x 15 cm

col. 23
Cromo/bianco
Chromed/white
Chromé/blanc
Chrom/Weiss
Cromado/blanco
Хром/белый



ABS, resine termoplastiche - ABS, thermoplastic resins
ABS, thermoplastique - ABS, Kunststoff
ABS, resinas termoplásticas - ABS, термопластичные смолы

GS07002

Ø 3,5 x 6,5 x 9 cm

col. 23
Cromo/bianco
Chromed/white
Chromé/blanc
Chrom/Weiss
Cromado/blanco
Хром/белый



ABS, resine termoplastiche - ABS, thermoplastic resins
ABS, thermoplastique - ABS, Kunststoff
ABS, resinas termoplásticas - ABS, термопластичные смолы

GS07003

Ø 3 x 5 cm

col. 13
Cromato
Chromed
Chromé
Chrom
Cromado
Хром



ABS, ottone - ABS, brass
ABS, laiton - ABS, Messing
ABS, latón - ABS, латунь

GS07004

Ø 3,3 x 14,5 cm

col. 13
Cromato
Chromed
Chromé
Chrom
Cromado
Хром



ABS, acciaio inox, ottone - ABS, stainless steel, brass
ABS, acier inox, laiton - ABS, Edelstahl, Messing
ABS, acero inoxidable, latón - ABS, нержавеющая сталь, латунь

GS07005

Ø 3,5 x 10,5 cm

col. 13
Cromato
Chromed
Chromé
Chrom
Cromado
Хром



ABS, acciaio inox, ottone - ABS, stainless steel, brass
ABS, acier inox, laiton - ABS, Edelstahl, Messing
ABS, acero inoxidable, latón - ABS, нержавеющая сталь, латунь

GS07006

Ø 3,4 x 10,5 cm

col. 23
Cromo/bianco
Chromed/white
Chromé/blanc
Chrom/Weiss
Cromado/blanco
Хром/белый



PVC, resine termoplastiche - PVC, thermoplastic resins
PVC, thermoplastique - PVC, Kunststoff
PVC, resinas termoplásticas - PVC, термопластичные смолы

GS07007

Ø 3,5 x 6 cm

col. 13
Cromato
Chromed
Chromé
Chrom
Cromado
Хром



ABS, resine termoplastiche - ABS, thermoplastic resins
ABS, thermoplastique - ABS, Kunststoff
ABS, resinas termoplásticas - ABS, термопластичные смолы

GS07008

Ø 3,5 x 14,5 cm

col. 23
Cromo/bianco
Chromed/white
Chromé/blanc
Chrom/Weiss
Cromado/blanco
Хром/белый



ABS, resine termoplastiche - ABS, thermoplastic resins
ABS, thermoplastique - ABS, Kunststoff
ABS, resinas termoplásticas - ABS, термопластичные смолы

G • ACCESSORIES

Varie possibilità di sostituzione di accessori e particolari per la zona doccia, dai supporti per le doccette e i saliscendi, ai kit per la sostituzione areatori in varie misure, alle prese d'acqua, deviatori e braccetti con connessione universale.

Différentes possibilités de remplacement d'accessoires et de pièces pour la zone douche : supports de douchette, barres de douche, kits pour le remplacement des aérateurs dans différentes dimensions, prises d'eau, déviateurs et bras avec connexion universelle.

Varias posibilidades de sustitución de accesorios y detalles para la zona ducha, desde los soportes para los mangos de ducha y los soportes deslizantes, los kits para la sustitución aireadores de varias medidas, hasta las toma de agua, los desviadores y los brazos con conexión universal.

A host of replacement possibilities for accessories and details for the shower area, from brackets to sliding bars, kits for aerator replacement in different sizes, water inlets, deflectors and brackets with universal connection.

Erschiedene Möglichkeiten der Ersetzung von Zubehör- und Ersatzteile im Duschbereich, von den Handduschenhalterungen zu den Wandschienen und von den Kits für die Ersetzung der Lüfter in verschiedenen Größen zu den Wasseranschlüssen, Umleitern und Armen mit Universalanschluss.

Богатый ассортимент аксессуаров и дополнений для душа, начиная от держателей для ручных душей и штанг до наборов для смены аэракторов различных размеров, соединений для подвода воды, девиаторов и держателей с универсальным креплением.

GS10001

6 x 39 x 4,3 cm

col. 13
Cromato
Chromed
Chromé
Chrom
Cromado
Хром



Ottone - Brass
Laiton - Messing
Latón - Латунь

Connessione
UNIVERSALE
Universal
CONNECTION

Realizzati in ABS - Made of ABS - Réalisés en ABS - Hergestellt aus ABS
Realizados en ABS - Изготовлено из АБС пластик

GS10006

Ø 4,8 x 8 cm

col. 13
Cromato
Chromed
Chromé
Chrom
Cromado
Хром



Supporto doccetta snodato - connessione universale
Jointed shower bracket - universal connection
Support articulé douchette - connexion universelle
Gelenkhalterung für Brausekopf - Universelle Verbindung
Soporte articulado ducha - conexión universal
Шарнирный держатель душа - Универсальное крепление

GS10007

Ø 5 x 4,1 cm

col. 13
Cromato
Chromed
Chromé
Chrom
Cromado
Хром



Supporto doccetta fisso - connessione universale
Fixed shower bracket - universal connection
Support fixe douchette - connexion universelle
Unbeweglicher Brausekopfhalter - Universelle Verbindung
Soporte fijo ducha - conexión universal
Фиксированный кронштейн душ - Универсальное крепление

GS10002

Ø 5 x 14 x Ø 1,8 cm

col. 13
Cromato
Chromed
Chromé
Chrom
Cromado
Хром



Acciaio inox - Stainless steel
Acier inox - Edelstahl
Acero inoxidable - Нержавеющая сталь

GS10003

Ø 6 x 20 x Ø 2 cm

col. 13
Cromato
Chromed
Chromé
Chrom
Cromado
Хром



Acciaio inox - Stainless steel
Acier inox - Edelstahl
Acero inoxidable - Нержавеющая сталь

GS10008

Ø 6,5 x 9 cm

col. 13
Cromato
Chromed
Chromé
Chrom
Cromado
Хром



Supporto doccetta snodato
Jointed shower bracket
Support articulé douchette
Gelenkhalterung für Brausekopf
Soporte articulado ducha
Шарнирный держатель душа

GS10004

Ø 6 x 30 x Ø 2 cm

col. 13
Cromato
Chromed
Chromé
Chrom
Cromado
Хром



Acciaio inox - Stainless steel
Acier inox - Edelstahl
Acero inoxidable - Нержавеющая сталь

GS10010

Ø 7 x 10,5 cm

col. 13
Cromato
Chromed
Chromé
Chrom
Cromado
Хром



Con ventosa
With suction cup
Avec ventouse
Mit Saugnapf
С присоской

Supporto doccetta snodato
Jointed shower bracket
Support articulé douchette
Gelenkhalterung für Brausekopf
Soporte articulado ducha
Шарнирный держатель душа

GS10009

Ø 6 x 7,5 cm

col. 13
Cromato
Chromed
Chromé
Chrom
Cromado
Хром



Con ventosa
With suction cup
Avec ventouse
Mit Saugnapf
С присоской

Supporto doccetta fisso
Fixed shower bracket
Support fixe douchette
Unbeweglicher Brausekopfhalter
Soporte fijo ducha
Фиксированный кронштейн душ

GS10005

Ø 6 x 40 x Ø 2 cm

col. 13
Cromato
Chromed
Chromé
Chrom
Cromado
Хром

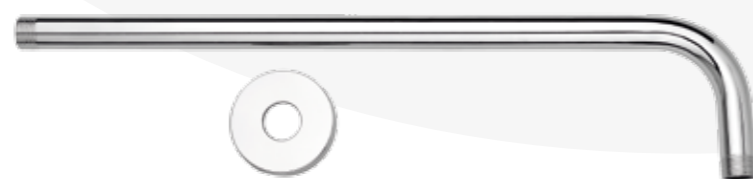

Acciaio inox - Stainless steel
Acier inox - Edelstahl
Acero inoxidable - Нержавеющая сталь

GS10011

19 x 7 x 4,5 cm

col. CT
Cromato/trasparente
Chromed/transparent
Chromé/transparent
Chrom/Transparent
Cromado/transparente
Хром/прозрачном



Conessione
UNIVERSALE
Universal
CONNECTION

GS10016

5 x 6 x 5 cm

col. 13
Cromato
Chromed
Chromé
Chrom
Cromado
Хром



ABS - АБС пластик

Preso acqua - connessione universale - Water inlet - universal connection
Prise d'eau - connexion universelle - Wasserentnahme - Universelle Verbindung
Toma agua - conexión universal - Подвод воды - Универсальное крепление

GS10017

Ø 5,5 x 3,5 x 8,5 cm

col. 13
Cromato
Chromed
Chromé
Chrom
Cromado
Хром



Ottone - Brass - Laiton - Messing - Latón - Латунь

Curveta con rosone a 90° - connessione universale
90° bend with rosette surround - universal connection
Coude avec plaque à 90° - connexion universelle
Kurve mit 90° Befestigungsplatte - Universelle Verbindung
Codo con plaqueta de 90° - conexión universal
- Колено с накладкой 90° - Универсальное крепление

GS10012

15 x 10 x 5 cm

col. 13
Cromato
Chromed
Chromé
Chrom
Cromado
Хром



GS10013

17 x 9 x 3 cm

col. 13
Cromato
Chromed
Chromé
Chrom
Cromado
Хром



GS10018

6 x 4,5 x 2,5 cm

col. 13
Cromato
Chromed
Chromé
Chrom
Cromado
Хром



Ottone - Brass - Laiton - Messing - Latón - Латунь

Deviatore acqua 2 vie - connessione universale
2-way water diverter - universal connection
Déviateur d'eau à 2 voies - connexion universelle
2-Wege-Umschalter - Universelle Verbindung
Desviador agua de 2 vías - conexión universal
Девiator на 2 отверстия - Универсальное крепление

GS10019

3,5 x 4,5 x 9 cm

col. 13
Cromato
Chromed
Chromé
Chrom
Cromado
Хром



ABS - АБС пластик

Braccetto con presa acqua - Arm with water inlet
Bras avec prise d'eau - Arm mit Wasserentnahme
Brazo con toma agua - Держатель с подводом воды

GS10014

16,5 x 8,4 x 3,5 cm

col. 13
Cromato
Chromed
Chromé
Chrom
Cromado
Хром



GS10015

17 x 9 x 3 cm

col. OO
Trasparente
Transparent
Transparent
Transparent
Transparente
Лрозрачном



GS10020

Ø 3 x 4 cm

col. 13
Cromato
Chromed
Chromé
Chrom
Cromado
Хром



ABS - АБС пластик

Regolatore di flusso 40/70% - connessione universale
Flow adjuster 40/70% - universal connection
Régulateur de débit 40/70% - connexion universelle
Durchflussregler 40/70% - Universelle Verbindung
Regulador de caudal 40/70% - conexión universal
Регулятор потока 40/70% - Универсальное крепление

Filtro antisabbia - Sand filter
Filtre anti-sable - Sandschutzfilter
Filtro antiarena - Фильтр от песка

GS10021

Ø 3,8 x 11 cm

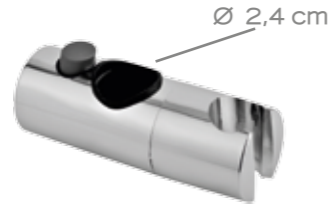

Connessione universale - Universal connection
Connexion universelle - Universelle Verbindung
Conexión universal - Универсальное крепление

GS10022

Ø 4,5 x 11 cm



GS10023

Ø 4 x 10,5 cm



GS10024

Ø 3,3 x 10,3 x 5,7 cm

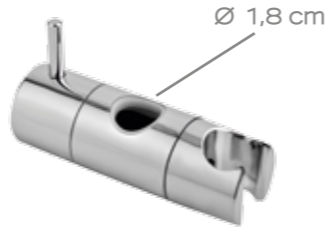

GS10025

Ø 3,7 x 7 cm



Interasse variabile - Adjustable distance
Distance variable - Höhenverstellbares Abstand
Distancia variable - Регулируемое межосевое расстояние

GS10026

Ø 4,3 x 7 cm



GS10027

Ø 4,8 x 8,5 cm



Interasse variabile - Adjustable distance
Distance variable - Höhenverstellbares Abstand
Distancia variable - Регулируемое межосевое расстояние

GS10028

Ø 2,5 x 8 cm



GS10029

Ø 9,5 x 1,5 cm

col. 08
Grigio
Grey
Gris
Grau
Gris
Серый



Disco getti per art. GS01032 - Jet disc for item GS01032
Disque pour jets pour article GS01032
Strahlscheibe für Artikel GS01032 - Disco chorros para artículo GS01032
Насадка для артикула GS01032

Resine termoplastiche - Thermoplastic resins
Thermoplastique - Kunststoff
Resinas termoplásticas - Термопластичные смолы

GS10031

Ø 2,2 x 1,8 cm

col. 13
Cromato
Chromed
Chromé
Chrom
Cromado
Хром



Set da 2 pezzi aeratore femmina ø 22
2-piece female aerator set ø 22
Jeu de 2 pièces aérateur femelle ø 22
2-teiliger Set Perlator Aufnahmeteil ø 22
Kit de 2 piezas aireador hembra ø 22
2-х частей женские аэратор

Metallo/resine termoplastiche - Metal/thermoplastic resins
Métal/thermoplastique - Metall/Kunststoff
Metal/resinas termoplásticas - Металлический/Термопластичные смолы

GS10030

Ø 2,4 x 1,4 cm

col. 13
Cromato
Chromed
Chromé
Chrom
Cromado
Хром



Set da 2 pezzi aeratore maschio ø 24 - 2-piece male aerator set ø 24
Jeu de 2 pièces aérateur mâle ø 24
2-teiliger Set Perlator Küchel ø 24 - Kit de 2 piezas aireador macho ø 24
Частей MALE аэратор ø 24

Metallo/resine termoplastiche - Metal/thermoplastic resins
Métal/thermoplastique - Metall/Kunststoff
Metal/resinas termoplásticas - Металлический/Термопластичные смолы

GS10032

Ø 2,8 x 1,4 cm

col. 13
Cromato
Chromed
Chromé
Chrom
Cromado
Хром



Set da 2 pezzi aeratore maschio ø 28
2-piece male aerator set ø 28
Jeu de 2 pièces aérateur mâle ø 28
2-teiliger Set Perlator Küchel ø 28
Kit de 2 piezas aireador macho ø 28
Частей MALE аэратор ø 28

Metallo/resine termoplastiche - Metal/thermoplastic resins
Métal/thermoplastique - Metall/Kunststoff
Metal/resinas termoplásticas - Металлический/Термопластичные смолы

GS10033

Ø 2,2 x 4 cm

GS10034

Ø 2,4 x 4 cm

col. 13
Cromato
Chromed
Chromé
Chrom
Cromado
Хром



Snodo bidet
Bidet joint
Articulation bidet
Bidetgelenkteil
Articulación bidé
Акционерное биде

Metallo/resine termoplastiche - Metal/thermoplastic resins
Métal/thermoplastique - Metall/Kunststoff
Metal/resinas termoplásticas - Металлический/Термопластичные смолы

GS10035

Ø 2,2/2,4/2,8 x 1,3 cm

col. 13
Cromato
Chromed
Chromé
Chrom
Cromado
Хром



Set da 3 filtri ø 24/22 - 1 filtro ø 28 mm
Set of 3 filters ø 24/22 - 1 filter ø 28
Jeu de 3 filtres ø 24/22 - 1 filtre ø 28
3-Filter-Set ø 24/22 - 1-Filter ø 28
Kit de 3 filtros ø 24/22 - 1 filtro ø 28
Набор 3 фильтры 2 x 24/22 - 1 x 28 mm

Metallo/resine termoplastiche - Metal/thermoplastic resins
Métal/thermoplastique - Metall/Kunststoff
Metal/resinas termoplásticas - Металлический/Термопластичные смолы

GS09009

Ø 6 x 120 cm

col. 13
Cromato
Chromed
Chromé
Chrom
Cromado
Хром



Ø 1,4 cm

Acciaio inox/attacchi in ottone - Stainless steel/brass nuts
Acier inox/écrous en laiton - Rostfreier Stahl/Nüsse aus Messing
Acero inoxidable/tuercas en latón - Нержавеющая сталь/латунные гайки

GS10038

5 x 2 x 8 cm

col. 11
Azzurro
Light blue
Bleu ciel
Hellblau
Azul celeste
Голубой



Chiavetta per aeratori - Key for aerators
Clé pour aérateur - Schlüssel für Perlator
Llave para aireadores - Ключ к аэратору

Realizzati in ABS - Made of ABS - Réalisés en ABS - Hergestellt aus ABS
Realizados en ABS - Изготовлено из АБС пластик



GS10036

Ø 5 x 5 x 18 cm



col. 13
Cromato
Chromed
Chromé
Chrom
Cromado
Хром

Realizzato in ABS - Made of ABS - Réalisé en ABS - Hergestellt aus ABS
Realizado en ABS - Изготовлено из АБС пластик



Water Saving



Anticalcare
Anti-limestone
Anticalcaire
Kesselsteinlösemittel
Antical
Защита от известкового налета



GS10037

Ø 5 x 5 x 15,8 cm



col. 13
Cromato
Chromed
Chromé
Chrom
Cromado
Хром

Realizzato in ABS - Made of ABS - Réalisé en ABS - Hergestellt aus ABS
Realizado en ABS - Изготовлено из АБС пластик



Water Saving



Anticalcare
Anti-limestone
Anticalcaire
Kesselsteinlösemittel
Antical
Защита от известкового налета



SENSORIAL

SENSORIAL

Tappeti in cotone

Cotton mats - Tapis en coton - Matten aus Baumwolle
Alfombras de algodón - Хлопок



G•BOMBAY

BO 5080



TRATTAMENTO ANTISCIVOLO SPRAY LATEX
ANTISLIP SPRAY LATEX BACKING
ENVERS ANTIGLISSANT
LATEXÉ SPRAY
MIT GLEITSCHUTZENDER SPRAY
LATEXBESCHICHTUNG
CON RECUBRIMIENTO DE LATEX SPRAY CONTRA RESBALÓN
С ЗАВОЛАКВАНІЕМ СПРАЙ

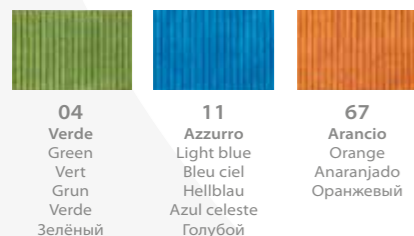

G•DELHI

DE 5080

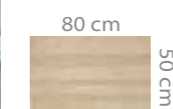

REVERSIBILE
REVERSIBLE - RÉVERSIBLE
WENDE-DESIGN - REVERSIBLE - РЕВЕРЗИБЕЛЬНО

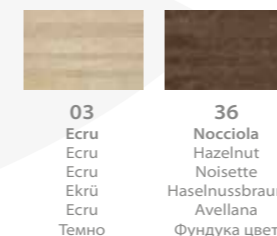
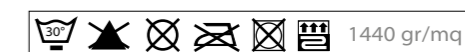

G•BRAMANTE

96 6850

96 6860

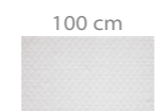
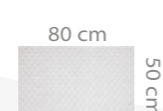

TRATTAMENTO ANTISCIVOLO SPRAY LATEX
ANTISLIP SPRAY LATEX BACKING
ENVERS ANTIGLISSANT
LATEXÉ SPRAY
MIT GLEITSCHUTZENDER SPRAY
LATEXBESCHICHTUNG
CON RECUBRIMIENTO DE LATEX SPRAY CONTRA RESBALÓN
С ЗАВОЛАКВАНІЕМ СПРАЙ



G•KLIMT

96 7340

96 7350

96 7360

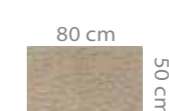
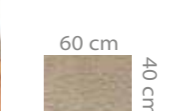

FONDO IN LATEX
LATEX BACKING - ENVERS LATEXÉ
LATEXBESCHICHTUNG - RECUBRIMIENTO DE LÁTEX
С ЛАТЕКСОВЫМ НИЖНИМ СЛОЕМ
LATEX BACKING - ENVERS LATEXÉ
LATEXBESCHICHTUNG - RECUBRIMIENTO DE LÁTEX
С ЛАТЕКСОВЫМ НИЖНИМ СЛОЕМ





G•MANTEGNA

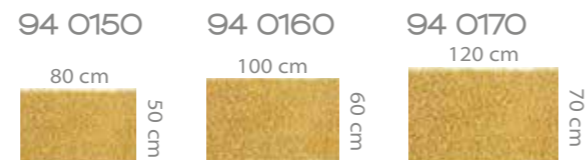

TRATTAMENTO ANTISCIVOLO SPRAY LATEX
 ANTISLIP SPRAY LATEX BACKING - ENVERS ANTIGLISSANT
 LATEXÉ SPRAY - MIT GLEITSCHUTZENDER SPRAY
 LATEXBESCHICHTUNG
 CON RECUBRIMIENTO DE LATEX SPRAY CONTRA RESBALÓN
 С ЗАВОЛАКИВАНИЕМ СПРАЙ

57% poliestere - polyester - polyester - Polyester - poliester - полиэстер
 43% cotone - cotton - coton - Baumwolle - algodón - хлопок



73 Argento
Silver
Argent
Silber
Plata
Серебро

87 Oro
Gold
Or
Золото



G•TINTORETTO

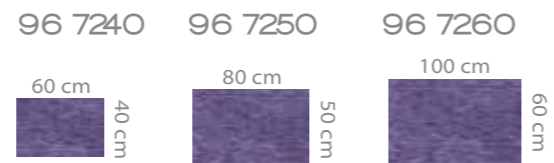

FONDO IN LATEX
 LATEX BACKING - ENVERS LATEXÉ - LATEXBESCHICHTUNG
 RECUBRIMIENTO DE LÁTEX - С ЛАТЕКСОВЫМ НИЖНИМ СЛОЕМ
 LATEX BACKING - ENVERS LATEXÉ
 LATEXBESCHICHTUNG - RECUBRIMIENTO DE LÁTEX
 С ЛАТЕКСОВЫМ НИЖНИМ СЛОЕМ

25% poliestere - polyester - polyester - Polyester - poliester - полиэстер
 75% cotone - cotton - coton - Baumwolle - algodón - хлопок



11 Azzurro
Light blue
Bleu ciel
Hellblau
Azul celeste
Голубой

67 Arancio
Orange
Anaranjado
Оранжевый

76 Fucsia
Fuchsia
Fuchsia
Fuchsia
Fucsia
Фуксия

79 Lilla
Lilacs
Lilas
Fieder
Lila
Сирень



G•TIZIANO



TRATTAMENTO ANTISCIVOLO SPRAY LATEX
 ANTISLIP SPRAY LATEX BACKING - ENVERS ANTIGLISSANT
 LATEXÉ SPRAY - MIT GLEITSCHUTZENDER SPRAY
 LATEXBESCHICHTUNG
 CON RECUBRIMIENTO DE LATEX SPRAY CONTRA RESBALÓN
 С ЗАВОЛАКИВАНИЕМ СПРАЙ

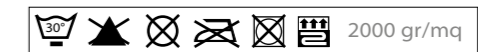

06 Rosso
Red
Rouge
Rot
Rojo
Красный

29 Moka
Moka

67 Arancio
Orange
Anaranjado
Оранжевый



G•UDAIPUR

UD 5080



TRATTAMENTO ANTISCIVOLO SPRAY LATEX
 ANTISLIP SPRAY LATEX BACKING
 ENVERS ANTIGLISSANT
 LATEXÉ SPRAY - MIT GLEITSCHUTZENDER SPRAY
 LATEXBESCHICHTUNG
 CON RECUBRIMIENTO DE LATEX SPRAY CONTRA RESBALÓN
 С ЗАВОЛАКИВАНИЕМ СПРАЙ



49 Bianco/Fucsia/Lilla
White/Fuchsia/Lilac
Blanc/Fuchsia/Lilas
Weiss/Fuchsie/Fieder
Blanco/Fucsia/Lila
Белый/Фуксия/
Сирень

89 Bianco/Blu/Verde
White/Blue/Green
Blanc/Bleu/Vert
Weiss/Blau/Grün
Blanco/Azulón/Verde
Белый/Голубой/Зелёный

93 Bianco/Arancio/Rosso
White/Orange/Red
Blanc/Orange/Rouge
Weiss/Orange/Rot
Blanco/Aranjado/Rojo
Белый/Оранжевый/
Красный

Tappeti in microfibra

Microfiber mats - Tapis en microfibre - Matten aus Mikrofaser
Alfombras de microfibra - Ковры из микрофибры



G•DONATELLO

94 0240 94 0250 94 0260

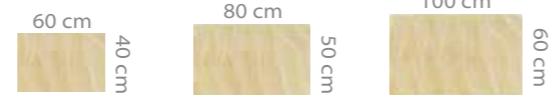

FONDO IN LATEX

LATEX BACKING - ENVERS LATEXÉ - LATEXBESCHICHTUNG
RECUBRIMIENTO DE LÁTEX - С ЛАТЕКСОВЫМ НИЖНИМ СЛОЕМ

100% poliestere - polyester - polyester - Polyester - poliester - полиэстер

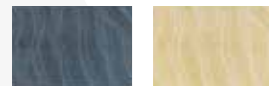
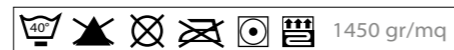

08
Grigio
Grey
Gris
Grau
Gris
Серый

17
Crema
Cream
Crème
Cream
Crema
крем

Tappeti in poliacrilico 100% fondo in latex

100% polyacrylic mats with latex backing - Tapis en polyacrylique 100% avec envers latexé
Matten aus Polyacryl 100% mit gleitschützender Latexbeschichtung
Alfombras de acrilico 100% con recubrimiento de látex - Коврики из 100% акрила, с заволакиванием латекса



G•BERNINI

95 4555 95 4560 95 4570



08
Grigio
Grey
Gris
Grau
Gris
Серый

79
Lilla
Lilacs
Lilas
Fieder
Lila
Сирень



G•BRONZINO

95 4850 95 4860 95 4870

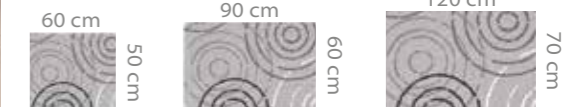

08
Grigio
Grey
Gris
Grau
Gris
Серый





G·BRUEGEL

95 4650 95 4660 95 4670
 60 cm 90 cm 120 cm
 50 cm 60 cm 70 cm



85
 Antracite
 Anthracite
 Anthrazit
 Antracita
 Антрацит



G·DAVID

95 3855 95 3860 95 3870
 65 cm 100 cm 120 cm
 55 cm 60 cm 70 cm



53
 Rubino
 Ruby red
 Rubis
 Rubinrot
 Rubi
 Рубиново-красный



G·BUONARROTI

95 4750 95 4760 95 4770
 65 cm 100 cm 120 cm
 50 cm 60 cm 70 cm



05
 Blu
 Blue
 Bleu
 Blau
 Azulón
 Синий



G·DELACROIX

95 4155 95 4160 95 4170
 65 cm 100 cm 120 cm
 55 cm 60 cm 70 cm



67
 Arancio
 Orange
 Anaranjado
 Оранжевый



G·HAYEZ



95 4355	95 4360	95 4370
65 cm	100 cm	120 cm
 55 cm	 60 cm	 70 cm



08
Grigio
Grey
Gris
Grau
Gris
Серый



G·MOREAU



95 4055	95 4060	95 4070
65 cm	100 cm	120 cm
 55 cm	 60 cm	 70 cm



05
Blu
Blue
Bleu
Blau
Azulón
Синий



G·MOORE

95 4455	95 4460	95 4470
65 cm	90 cm	120 cm
 55 cm	 60 cm	 70 cm





06
Rosso
Red
Rouge
Rot
Rojo
Красный



07
Verde
Green
Vert
Grün
Verde
Зелёный

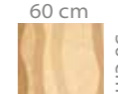

G·PINTURICCHIO

95 3750	95 3760	95 3765
60 cm	90 cm	115 cm
 50 cm	 60 cm	 65 cm



03
Beige
цвет
шампанского



G•REDON

95 3955 95 3965 95 3970
 65 cm 105 cm 120 cm
 55 cm 65 cm 70 cm



03 Beige
 цвет шампанского
 67 Arancio
 Orange
 Anaranjado
 Оранжевый



G•SISLEY

95 2160 95 2180
 ø 60 cm ø 80 cm



90 Multicolore
 Multicolor
 Mehrfarbig
 Многоцветный

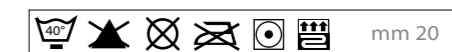

G•SANZIO

95 4255 95 4260 95 4270
 65 cm 100 cm 120 cm
 55 cm 60 cm 70 cm



52 Tortora
 Turtledove grey
 Blanc
 Weiss
 Blanco
 Белый



G•VECELLIO

95 4955 95 4960 95 4970
 65 cm 90 cm 120 cm
 55 cm 60 cm 70 cm



05 Blu
 Blue
 Bleu
 Blau
 Azulón
 Синий





G•VERONESE

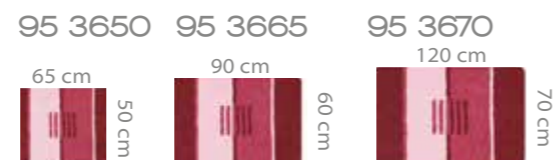

10
Rosa
Pink
Rose
Розовый



mm 20

SIMBOLOGIA

- 

Da lavare come tessuto di cotone, lavaggio a temperatura indicata
Treat as cotton, wash at recommended temperature
Laver comme tissu en coton, lavage à la température indiquée
Waschgang und Waschtemperatur wie für Baumwolle
Debe lavarse como tejido de algodón, lavado a la temperatura indicada
Стирать как хлопчатобумажные ткани, стирка при указанной температуре
- 

Da lavare come tessuto sintetico, lavaggio a temperatura indicata
Treat as synthetic fabric, wash at recommended temperature
Laver comme tissu synthétique, lavage à la température indiquée
Waschgang und Waschtemperatur wie für Synthetikstoffe
Debe lavarse como tejido sintético, lavado a la temperatura indicada
Стирать как синтетические ткани, стирка при указанной температуре
- 

Non candeggiare
Do not bleach
Ne pas javelliser
Nicht bleichen
No usar lejía
Не использовать отбеливающие средства
- 

Non adatto al lavaggio a secco
Do not dry clean
Inadapté au lavage à sec
Nicht trockenreinigen
No lavar a seco
Не подвергать сухой стирке
- 

Non stirare
Do not iron
Ne pas repasser
Nicht bügeln
No planchar
Не гладить
- 

Adatto all'asciugatura con asciugabiancheria
Can be tumble-dried
Adapté au séchage en sèche-linge
Wäschetrocknergeeignet
Se puede secar en secadora de ropa
Разрешается сушить в сушилке для белья
- 

Asciugare a bassa temperatura
Dry at low temperature
Sécher à basse température
Bei niedrigen Temperaturen trocknen
Secar a baja temperatura
Сушить при низкой температуре
- 

Fondo in latex traspirante
Transpiring latex backing
Envers transpirant latexé
Mit transpirierender Latexbeschichtung
Recubrimiento de látex transpirante
Основа из воздухопропускающего латекса



HOTELLERIE

HOTELLERIE

Articoli per comunità

Contract sector range - Collection pour communautés - Contract-Sektor Sortiment -
Gama para comunidades - Гамма для отелей и общественных зданий



5054 G • GRECALE SHAVER

11 x 32,2 x 29,5 cm

Asciugacapelli con presa rasoio

Hair dryer with electrical socket for shavers
Sèche cheveux avec prise pour les rasoirs
Haartrockner mit Steckdose für Rasierapparaten
Secador de pelo com toma de corrente para maquinillas de afeitar
Фен с розеткой для электробритов



Resine termoplastiche/acciaio inox

Thermoplastic resins/stainless steel
Thermoplastique/acier inoxydable
Kunststoff/Edelstahl
Resinas termoplásticas/acero inox
термопластическая смола/нержавеющая сталь

CE W 1300 - IPX0

02

Bianco
White

5053 G • ZEFIRO

9 x 15 x 33 cm

Asciugacapelli

Hair dryer
Sèche cheveux
Haartrockner
Secador de pelo - Фен

Resine termoplastiche

Thermoplastic resins
Thermoplastique
Kunststoff
Resinas termoplásticas
термопластические смолы

CE W 1200 - IPX0



5052 G • ALBATROS

Design: Antonio Rossari

59,5 x 30,5 x 16 cm

Asciugacapelli con supporto a parete

Hair dryer with wall support
Sèche cheveux avec support mural
Haartrockner mit Wandhalter
Secador para el cabello con soporte - Фен

Resine termoplastiche

Thermoplastic resins - Thermoplastique
Metall und Kunststoff
Metal y resinas termoplásticas
металл и термопластические смолы

CE W 1200 - IP20

02

Bianco
White

02

Bianco
White

4054 G • SCIROCCO SHAVER

14,6 x 9,5 x 50,6 cm

Asciugacapelli con presa rasoio

Hair dryer with electrical socket for shavers
Sèche cheveux avec prise pour les rasoirs
Haartrockner mit Steckdose für Rasierapparaten
Secador de pelo com toma de corrente para maquinillas de afeitar
Фен с розеткой для электробритов

Resine termoplastiche - Thermoplastic resins

Thermoplastique - Kunststoff
Resinas termoplásticas
термопластическая смола

CE W 700 - IPX2





2451

28,4 x 24,8 x 20,2 cm

Asciugamani antivandalo ad aria calda con pulsante

Vandal-proof hot air hand dryer with pushbutton action
Sèche-mains anti-vandalisme à air chaud avec bouton
Bruchsicherer Heissluft-Händetrockner mit Taste
Secador de aire caliente para las manos resistente al vandalismo con pulsador

Сушилка для рук с защитой от вандалов, с горячим воздухом и кнопкой

Acciaio porcellanato

Vitreous enamel steel - Acier émaillé
Emaile - Acero porcelanizado
Сталь, обработанная под фарфор

CE W 2400 - IPX1

02

Bianco
White

13

Cromato
lucido
Chromed



2452

21 x 15,5 x 31 cm

Asciugamani elettronico a fotocellula a spegnimento automatico

Photocell electronic hand-dryer with automatic switch off

Sèche-mains à cellule photo-électrique.
Arrêt automatique

Elektroniker Händetrockner mit Fozelle und automatischer Ausschaltung
Secamanos electrónico con celula fotoelectrica y apagado automático

Автоматическая электронная сушка для рук с фотозлементами

Resine termoplastiche

Thermoplastic resins - Thermoplastique
Metall und Kunststoff
Metal y resinas termoplásticas
металл и термопластичные смолы

CE W 1800 - IPX2

02

Bianco
White

02

Bianco
White

2084

340 ml - 5,7 x 11,5 x 25,5 cm

Dosatore da incasso per top lavabo

Built-in dispenser for washbasin top
Distributeur à encastrer pour dessus lavabo
Einbau-Seifenspender für Waschbecken-Top
Dosificador empotrado para top lavabo
Встраиваемый дозатор для умывальника

Ottone e resine termoplastiche

Brass and thermoplastic resins - Laiton et thermoplastique
Messing und Kunststoff - Latón y resinas termoplásticas
латуни и термопластичных смол

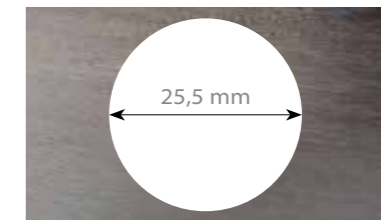

2426

28 x 18 x 25 cm - max ø 15

Distributore salviette di carta piegate o a rotolo

Dispenser for papersheets or paper-rolls
Distributeur papier en feuilles ou en rouleau
Papierspender für Einzelblätter oder Rollen
Dispensador de toallitas o de papel en rollo
Ёмкость для салфеток или рулона

Resine termoplastiche

Thermoplastic resins - Thermoplastique
Kunststoff - Resinas termoplásticas
Термопластичные смолы



2427

28 x 14 x 40 cm

Distributore di salviette di carta piegate

Dispenser for papersheets
Distributeur serviettes en feuille
Tuchspender für Einzelblätter
Dispensador de toallitas
Ёмкость для бумажных салфеток

Resine termoplastiche

Thermoplastic resins - Thermoplastique
Kunststoff - Resinas termoplásticas
Термопластичные смолы





2436

28 x 10 x 35 cm

Distributore salviette carta con serratura di sicurezza - max 400 fogli

Tissue dispenser with safety lock - max 400 tissues
Distributeur serviettes avec serrure de sûreté - max 400 serviettes
Tuchspender mit Sicherheitsschloß - max 400 Tücher
Dispensador de toallas con cierre de seguridad max 400 toallas
Ёмкость для бумажных салфеток. Снабжена замком - максимальные 400 тканей

Acciaio inox - Stainless steel - Acier inoxydable
Edelstahl - Acero inox
Нержавеющая сталь

13
Finitura lucida
Polished finishing

02 Bianco White
13 Cromato lucido Chromed



2437

17,8 x 18 x 31,8 cm - max ø 16

Distributore di carta asciugamani a spirale

Spiral paper hand towel dispenser
Distributeur de papier essuie-mains en spirale
Handtuchrollen-Spender
Dispensador de toallitas para secar las manos en espiral
Спиральный диспенсер бумаги для рук

Resine termoplastiche
Thermoplastic resins - Thermoplastique
Kunststoff - Resinas termoplásticas
Термопластичные смолы

02
Bianco White

13
Finitura lucida
Polished finishing



2308

23 x 7 x 12 cm

Porta fazzoletti

Tissue box
Boîte à mouchoirs - Tücherbehälter
Porta pañuelos - Ёмкость для салфеток

Acciaio inox - Stainless steel - Acier inoxydable
Edelstahl - Acero inox - нержавеющая сталь

13
Finitura lucida
Polished finishing

02
Bianco White

2008

Design: Makio Hasuike

25,8 x 13,2 x 6,3 cm

Porta fazzoletti

Tissue box
Boîte à mouchoirs - Tücherbehälter
Porta pañuelos - Ёмкость для салфеток

Realizzato in resine termoplastiche
Made of thermoplastic resins - Réalisé en thermoplastique
Hergestellt aus Tücherbehälter - Realizado en resinas termoplásticas
Изготовлено из термопластичной смолы



2424

31 x 12,5 x 32 cm - Max ø 30 cm

Distributore per rotoli di carta con serratura di sicurezza

Rollpaper dispenser with safety lock
Distributeur papier à rouleaux avec serrure de sûreté
Rollenpapierspender mit Sicherheitsschloß
Dispensador rollos de papel con cierre de seguridad
Ёмкость для туалетной бумаги. Снабжена замком

Acciaio inox - Stainless steel - Acier inoxydable
Edelstahl - Acero inox
Нержавеющая сталь



2028

27 x 12 x 25,5 cm - Max ø 24,5

Distributore di carta a rotoli Mini Jumbo

Rollpaper dispenser Mini Jumbo
Distributeur papier à rouleau Mini Jumbo
Rollenpapierspender Mini Jumbo
Dispensador rollos de papel Mini Jumbo
Ёмкость для туалетной бумаги Mini Jumbo

Resine termoplastiche
Thermoplastic resins - Thermoplastique
Kunststoff - Resinas termoplásticas
Термопластичные смолы





2429

37,5 x 13,5 x 36 cm - Max ø 34

Distributore di carta a rotoli Maxi Jumbo

Rollpaper dispenser Maxi Jumbo
Distributeur papier à rouleau Mini Jumbo
Rollenpapierspender Mini Jumbo
Dispensador rollos de papel Mini Jumbo
Ёмкость для туалетной бумаги Mini Jumbo

Resine termoplastiche

Thermoplastic resins - Thermoplastique
Kunststoff - Resinas termoplásticas
Термопластичные смолы

02

Bianco
White

13

Finitura
lucida
Polished
finishing

2725 G•ASCOT

Design: Carlo Vietri

12,3 x 12,5 x 8 cm

Portarotolo

Paper holder
Porte rouleau
Papierrollenhalter
Portarollo
Бумагодержатель

Acciaio inox - Stainless steel
Acier inoxydable - Acier inoxydable
Edelstahl - Acero inox
нержавеющая сталь



2439

14 x 13,5 x 15 cm

Distributore di carta igienica a rotoli o intercalata

Toilet paper dispenser for rolls or squares
Distributeur papier toilette en rouleau ou feuille a feuille
Toilettenpapierspender für rolle oder Einzelblatt
Dispensador papel higiénico en rollos o en hojas
Дисенсер туалетной бумаги рулонный и листовой

Resine termoplastiche

Thermoplastic resins
Thermoplastique
Kunststoff - Resinas termoplásticas
Термопластичные смолы

02

Bianco
White

02

Bianco
White

13

Cromato
lucido
Chromed

Porta sacchetti igienici - Holder for sanitary towel bags

Porte-sachets hygiéniques - Behälter für Hygienebeutel
Porta-bolsitas higiénicas - Урна для гигиенических прокладок

Fissaggio con biadesivo o viti - resine termoplastiche

Biadhesive or screw fixing - thermoplastic resins
Applicable avec biadhésif ou vis - thermoplastique
Mit doppelseitiger Klebstreifen oder Schrauben aufhängbar - Kunststoff
Aplicable con biadhesivo o tornillos - resinas termoplásticas
крепление винтами или двусторонней липкой лентой
термопластичная смола

2430

9,8 x 3,8 x 13,5 cm



2525

12 x 14,2 x 7,2 cm

Portarotolo coperto

Paper holder with cover
Porte rouleau avec couvercle
Papierrollenhalter mit Deckel
Portarollo con tapa
Бумагодержатель с крышкой

Acciaio inox/ Cromall® - Stainless steel/ Cromall®
Acier inoxydable/Cromall® - Edelstahl/Cromall®
Acero inox/Cromall® - Нержавеющая сталь/Cromall®

13

Cromato
lucido
Chromed

13

Finitura
lucida
Polished
finishing

G•TULLO

ø 9 x 6 cm

Filo stendibiancheria riavvolgibile

Retractable clothes line - Sèche linge retractable
Aufrollbarer Wäschetrockner - Tendedero enrollable ocultador
Выдвижная нить для сушки белья

Acciaio inox - Stainless steel - Acier inoxydable - Acier inoxydable
Edelstahl - Acero inox - нержавеющей сталь



13

Cromato
lucido
Chromed

Mensole porta asciugamani

Shelves for towels - Etagères porte serviette - Handtuchablage
Estantes para toallas - Держатель полотенца

Realizzate in acciaio inox e Cromall®

Made of stainless steel and Cromall® - Réalisée en acier inoxydable et Cromall®

Hergestellt aus Edelstahl und Cromall® - Realizados en acero inox y Cromall®

Изготовлено из нержавеющей сталь и Cromall®

2127

ø 1,8 x 3,3 cm

Ottone

Brass

Laiton

Messing

Latón

латунь



13

Cromato
lucido
Chromed

2435 G·ASCOT

Design: Carlo Vietri

59,5 x 30,5 x 16 cm

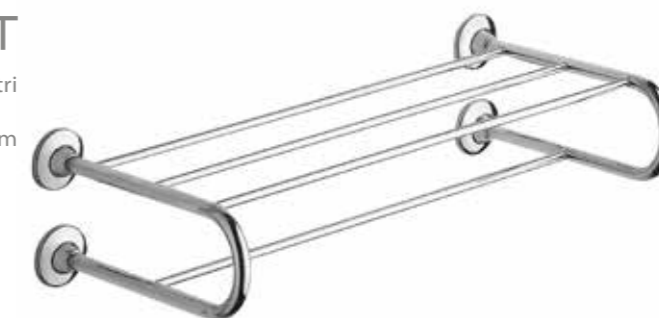

2128

20 x 3,1 x 4 cm

Appendino multiplo

Multiple hook - Crochet quadre têtes

Haken vierfach - Percha cuádruple - Кратный крючок

Cromall®/ottone

Cromall®/brass

Cromall®/laiton

Cromall®/Messing

Cromall®/latón

Cromall®/латунь



13

Cromato
lucido
Chromed

2735 G·ASCOT

Design: Carlo Vietri

60,4 x 30,4 x 12 cm



2744 G·ASCOT

Design: Carlo Vietri

60,4 x 30,4 x 5,9 cm



Maniglioni G·Ascot

Maniglioni realizzati in ottone, alluminio e Cromall® - Grab bars made of brass, aluminum and Cromall®
 Barres d'appui réalisées en laiton, aluminium et Cromall® - Wannengriffe hergestellt aus Messing, Aluminium und Cromall®
 Asideros realizados en latón, aluminio y Cromall® - Поручень изготовлено из латуни, алюминия и Cromall®

Design: Carlo Vietri



ø 25 - sp.1

13

Cromato
lucido
Chromed



ED35 G·EDERA

62,4 x 25,3 x 11,2 cm

13

Cromato
lucido
Chromed



ED44 G·EDERA

62,4 x 25,3 x 4,9 cm

13

Cromato
lucido
Chromed



FE35 G·FELCE

61,5 x 26,3 x 11,2 cm

13

Cromato
lucido
Chromed



FE44 G·FELCE

61,5 x 26,3 x 5,6 cm

13

Cromato
lucido
Chromed

2721 / 28

29 x 9,5 x 7,2 cm

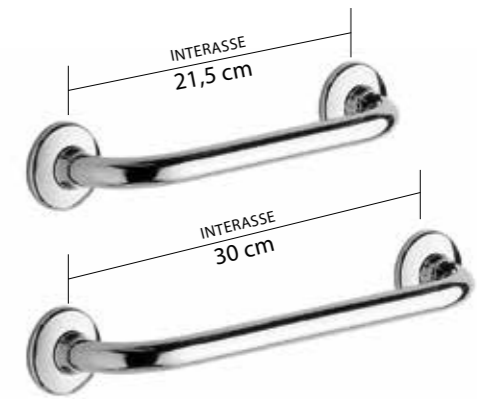

2721 / 37

37,2 x 9,5 x 7,2 cm



2721 / 67

67,4 x 9,5 x 7,2 cm

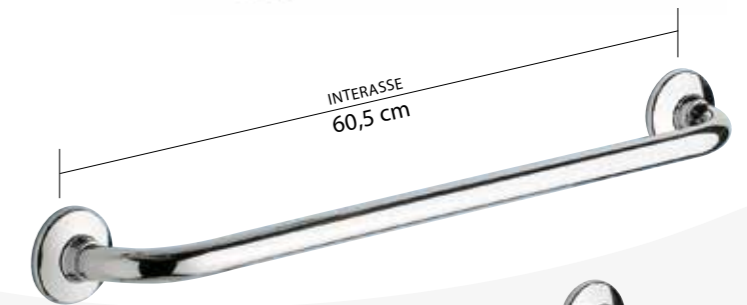

2722

49 x 9,5 x 22 cm

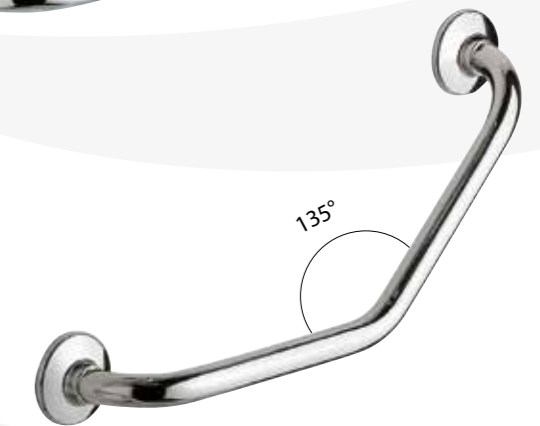

2720

49x12,6x22 cm



con portasapone in filo reversibile in acciaio inox
 with reversible wire soap holder in stainless steel
 avec porte savon fil réversible en acier inoxydable
 mit umkehrbarer Stabseifenschale in Edelstahl
 con jabonera de varillas móvil en acero inox
 с мыльницей с проволочным основанием
 в нержавеющей сталь

Maniglioni G·Edera

Maniglioni realizzati in ottone e Cromall® - Grab bars made of brass and Cromall®
Barres d'appui réalisées en laiton et Cromall® - Wannengriffe hergestellt aus Messing und Cromall®
Asideros realizados en latón y Cromall® - Поручень изготовлено из латуни и Cromall®



13

Cromato
lucido
Chromed

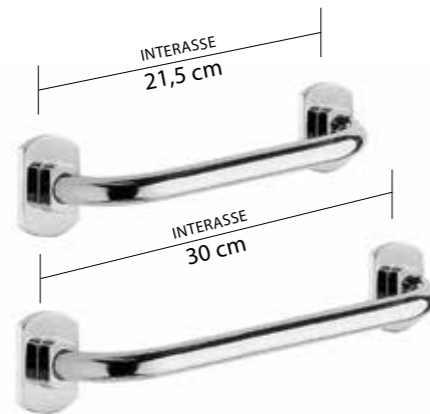

ED21 / 28

27 x 9,5 x 8 cm



ED21 / 37

35 x 9,5 x 8 cm

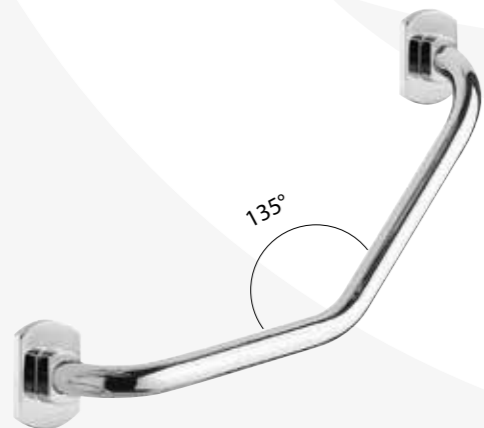

ED22

47 x 9,5 x 22,5 cm



ED20

47 x 12,5 x 23 cm



con portasapone in filo reversibile in acciaio inox
with reversible wire soap holder in stainless steel
avec porte savon fil réversible en acier inoxydable
mit umkehrbarer Stabseifenschale in Edelstahl
con jabonera de varillas móvil en acero inox
с мыльницей с проволочным основанием
в нержавеющей сталь

00

Materiale di consumo

Contract-sector range: refills - Collection pour hôtels et communautes: pièces de recharge
Contract-Sektor Sortiment: Nachfüllungsteile - Gama para hoteles y comunidades: piezas de recarga
Гамма для отелей: заполнение



2150

8,8 x 12 x 2,5 cm

Sacchetti igienici in plastica

Plastic hygienic bags

Sachets hygiéniques en plastique

Abfallbeutel aus Kunststoff

Bolsitas higiénicas en plástica

Гигиенические пакеты

6 conf. da 25 pz.

6 boxes of 25 pcs/each

6 conf.de 25 pièces/chaque

6 Boxen von 25 St/jds

6 confecciones de 25 piezas/cada

6 коробок 25 частей



2151 *

23 x 9,5 x 11 cm

Salviette piegate a C - conf. da 150 pz.

Folded towels - box of 150 pcs

Petites serviettes pliées - confection de 150 pièces

Gefaltete kleine Tücher - Box von 150 St.

Toallitas dobladas - confección de 150 piezas

Сложенные салфетки - коробка 150 уастей



2152 *

ø 22 x 11,5 cm

Confezione 6 rotoli carta igienica a 2 veli per mini Jumbo m. 200 cad.

Package containing 6 rolls of toilet tissue (m.200/each)

Paquet 6 rouleaux papier hygiénique (m.200/chaque)

Packung mit 6 Rollen Toilettenpapier (m.200/jds)

Paquete 6 rollos papel higiénico (m.200/cada)

Упаковка из 6 рулонов туалетной бумаги (200 m.)



2153 *

ø 31 x 11,5 cm

Confezione 6 rotoli carta igienica a 2 veli per maxi Jumbo m. 500 cad.

Package containing 6 rolls of toilet tissue (m.500/each)

Paquet 6 rouleaux papier hygiénique (m.500/chaque)

Packung mit 6 Rollen Toilettenpapier (m.500/jds)

Paquete 6 rollos papel higiénico (m.500/cada)

Упаковка из 6 рулонов туалетной бумаги (500 m.)



2154 *

41,5 x ø13 x 21 cm

Confezione 3 rotoli carta asciugatutto - m.50 cad.

Package containing 3 rolls of paper towels (m.50/each)

Paquet 3 rouleaux papier essuie-tout (m.50/chaque)

Packung mit 3 Papierrollen (m.50/jds)

Paquete 3 rollos papel secante (m.50/cada)

Упаковка из 3 рулонов абсорбирующей бумаги (50 m.)



2156 *

33 x 11,6 x 9,7 cm

Confezione 3 mazzette da 300 fogli carta igienica intercalata

Package of 3 bundles of 300 sheets of toilet paper squares

Confection 3 lots de 300 feuilles papier toilette feuille a feuille

3er-packung mit 300 einzelblätter toilettenpapier

Paquete 3 juegos de 300 hojas de papel higiénico

Упаковка из 3 пачек по 300 листов туалетной бумаги

* 100% pura cellulosa - 100% pure cellulose - 100% pure cellulose
100% reine Zellulose - 100% celulosa pura - целлюлоза 100% чисто

G•Prima classe



ø 32 mm



13

Finitura
cromato
lucido
Chromed
finishing

Programma in acciaio inox e nylon

Program made of stainless steel and nylon

Programme en acier inoxydable et nylon

Programm aus Edelstahl und Nylon

Programa en acero inox y nylon

Программа из нержавеющей стали и нилон

Un disegno aggiornato e moderno, massima funzionalità, materiali di alta qualità e un sistema modulare: questo il nuovo programma PRIMA CLASSE. Il sistema di sedute è composto da un esclusivo sedile ribaltabile per la doccia e da uno sgabello in differenti varianti di colori (bianco, cromo/bianco e cromo/grigio). Il sistema di maniglioni è realizzato in acciaio inox in finitura lucida e completato con il maniglione di sostegno e l'appoggio ribaltabile, con o senza portarotolo, dalla forma moderna e chic.

A modern up-to-date design, absolute functionality, high-quality materials and modular construction system: those are the outstanding characteristics of the new PRIMA CLASSE program of safety grab bars. The seat system is composed by an exclusive tilt-up shower seat and a bath stool in different colour variants (white, chrome/white and chrome/grey).

The handles are made of stainless steel in polished finishing and rounded off by the folding and support handle, with or without paper holder, in a modern and elegant design.

Un design actuel et moderne, une extrême fonctionnalité, des matériaux de haute qualité et un système modulaire: c'est la nouvelle collection PRIMA CLASSE. Le système de sièges est composé par un exclusif siège repliable pour la douche et par un tabouret en plusieurs couleurs (blanc, chromé/blanc et chromé/gris). Le système de barres est réalisé en acier inoxydable avec finition polie et complété par la barre d'appui et par la barre à abattant, avec ou sans porte papier, de forme moderne et chic.

Modernes zeitgemäßes Design, absolute Funktionalität, hochwertige Materialien und modulares Baukastensystem: Diese sind die herausragenden Merkmale des Sitz- und Grifffsystems PRIMA CLASSE. Das Sitzprogramm setzt sich aus einem exklusiven Duschklapsitz und einem Badehocker in verschiedenen Farbvarianten (weiß, chrom/weiß und chrom/grau) zusammen. Das Grifffsystem besteht aus poliertem Edelstahl und abgerundet wird dieses Programm durch den Klapp- und Stützgriff, mit oder ohne Papierrollenhalter, mit einer modernen eleganten Form.

Un diseño moderno, materiales de alta calidad, funcionalidad absoluta y modularidad: este el nuevo programa de asientos y de asideros de seguridad PRIMA CLASSE. El sistema de asientos se compone de un exclusivo asiento móvil para ducha y de un taburete en diversas variantes de color (blanco, cromo/blanco y cromo/gris). El programa de asideros es realizado en acero inoxidable en acabado brillo y es completado por el asidero móvil, con o sin portarrollo y el asidero de apoyo, de forma moderna y elegante.

Современная и обновленная конструкция, максимальная функциональность, высококачественные материалы и модульная система - все это новая программа "ПЕРВЫЙ КЛАСС". Система для сидения состоит из уникального откидного сиденья для душа и табурет различных цветов (белый, хромированный/белый и хромированный/серый). Система ручек изготовлена из нержавеющей стали с блестящей отделкой, дополнена поручнем и откидной ручкой с держателем для туалетной бумаги или без него в современном и шикарном стиле





6008

60 x 12,2 x 74,5 cm

Specchio basculante infrangibile in acciaio inox

Shatterproof tilting mirror in stainless steel

Miroir basculant infrangible en acier inox

Neigbarer bruchsicherer Spiegel aus Edelstahl

Espejo basculante irrompible de acero inoxidable

Поворотное зеркало небьющееся из нержавеющей стали

non certificato TÜV - Not TÜV certified - non certifié TÜV

Nicht TÜV-geprüft - no certificado TÜV

испытания на соответствие нормативу TÜV не проводились



CE
IP 23
W75 - R75

4942

23 x 13 x 7 cm

Lampada alogena per specchio 6008 ottone/vetro/resine termoplastiche

Lamp with halogen light for mirror 6008
brass/glass/thermoplastic resins

Applique avec lampe halogène pour miroir 6008
laiton/verre/thermoplastique

Leuchte mit Halogenlampe für Spiegel 6008
Messing/Glas/Kunststoff

Aplique con lámpara para espejo 6008
latón/cristal/résinas termoplásticas

Универсальная галогенная лапа для зеркала 6008
латунь/стекло/термопластичная смола

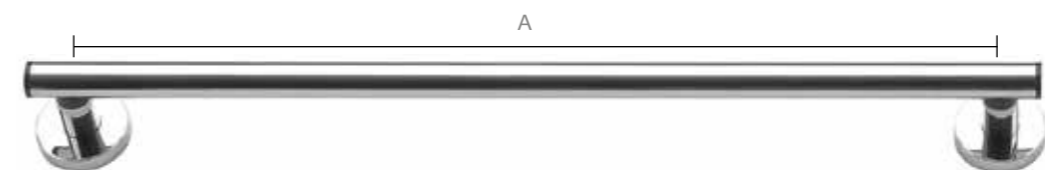

6021/25

A 25 cm
32,8 x 9,3 x 7,8 cm

6021/45

A 45 cm
52,8 x 9,3 x 7,8 cm

6021/55

A 55 cm
62,8 x 9,3 x 7,8 cm

6021/65

A 65 cm
72,8 x 9,3 x 7,8 cm



6043/10

112,8 x 9,3 x 7,8 cm



08

Antracite
Anthracite



6047

9,5 x 4,5 x 6 cm

Saliscendi - ABS

Shower support - ABS - Fixation douche ajustable - ABS

Duschhalterung - ABS - Soporte para ducha - ABS - Подвижный/ держатель для душа - ABS

6046

7,8 x 9,3 x 107,8 cm

Sostegno per doccia con saliscendi

Shower support with sliding rail - Barre pour douche avec système de fixation ajustable

Duschstangenhalterung - Soporte para ducha con columna - Штанга для душа

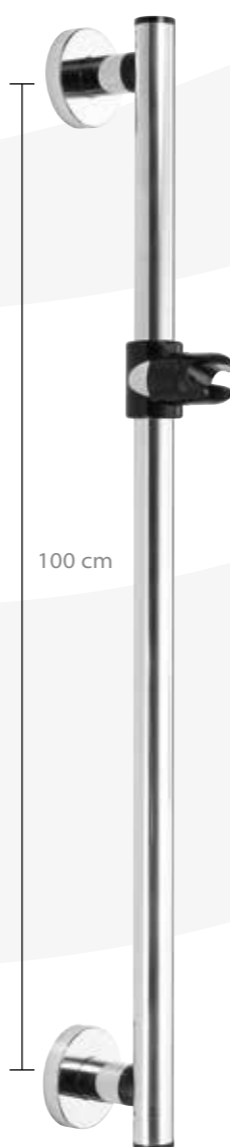

6090/44

66,5 x 9,3 x 51,5 cm

Reversibile

Reversible

Réversible

Reversibler

Reversible

Обратимый

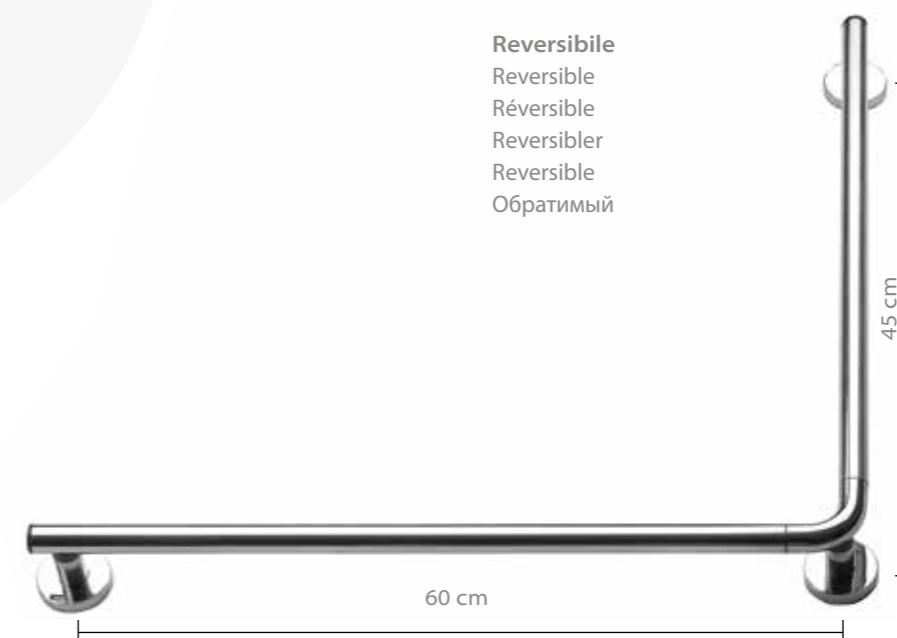

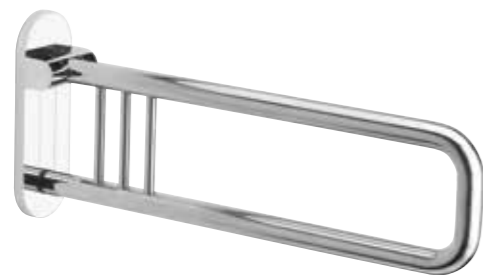

6057/65 ▲

10 x 65 x 28 cm

6057/75 ▲

10 x 75 x 28 cm

Appoggio ribaltabile

Safety folding handle - Barre à abattant
Klappgriff - Soporte móvil - Мобильный поручень

Design: Studio Talocci



6058/65 ▲

10 x 65 x 28 cm

6058/75 ▲

10 x 75 x 28 cm

Appoggio ribaltabile con portarotolo

Safety folding handle with paper holder - Barre à abattant avec porte
rouleau - Klappgriff mit Papierrollenhalter - Soporte móvil con portarrollo
Мобильный поручень с бумагодержателем

Design: Studio Talocci



▲ Meccanismo di ribaltamento in posizione orizzontale e verticale
Collapsible mechanism in horizontal and vertical position
Mécanisme de basculement en position horizontale et verticale
Kippmechanismus in waagerechter und in senkrechter Position
Mecanismo de abatimiento en posición horizontal y vertical
Откидной механизм в вертикальном и горизонтальном положении



6059/65

10 x 65 x 28 cm

Appoggio reversibile

Reversible safety handle
Support réversible
Wandstützgriff umkehrbar
Soporte móvil - Обратимый

Design: Studio Talocci



6083



35,5 x 37 x 10,5 cm

Sedile ribaltabile per doccia - alluminio/ABS

Shower seat - aluminium/ABS

Siège pour douche repliable - aluminium/ABS

Duschsitz hochklappbar - Aluminium/ABS

Asiento móvil para ducha - aluminio/ABS

Сиденье для душа - алюминий/ABS

Design: Studio Talocci



— 4,8 —

02 Bianco
White

23 Bianco/cromo
White/chromed

43 Antracite/cromo
Anthracite/chromed



6072



40,9 x 33,1 x 43,8 cm

Sgabello - alluminio/ABS

Stool - aluminium/ABS

Tabouret - aluminium/ABS

Hoher - Aluminium/ABS

Taburete - aluminio/ABS

Табурет - алюминий/ABS

Design: Studio Talocci

02 Bianco
White

23 Bianco/cromo
White/chromed

43 Antracite/cromo
Anthracite/chromed

G•Sicura

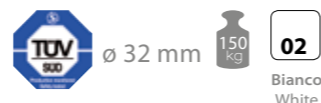

Programma in alluminio e nylon

Program made of aluminium and nylon
Programme en aluminium et nylon
Programm aus Aluminium und Nylon
Programa en aluminio y nylon
Программа из алюминий и нейлон

Un vastissimo programma di maniglioni e sistemi d'appoggio fissi e mobili in grado di soddisfare tutte le esigenze. Il sistema Sicura, messo a punto sulla base delle più recenti ricerche in tema di ergonomia, offre sicurezza e libertà dalle barriere architettoniche.

Possibilità di inserimento nel settore della riabilitazione, casa di cura per anziani, nel campo dei sanitari, case private e strutture pubbliche.

Copertura trattata con polveri speciali in resine epossidiche e poliestere, antiurto, antigraffio e non attaccabile dalle sostanze disinfettanti.

A very wide range of handles and fixed and movable supporting systems which will satisfy any requirements. The Sicura system, with designs based on the most recent research into ergonomics, offers safety and freedom from architectural barriers.

Can be used in the sector of rehabilitation, residential homes for the elderly, in the sanitary-ware field, private houses and public buildings.

Covering treated with special epoxy and polyester resins, shockproof, scratch-proof and resistant to attack by disinfectants.

Un très vaste éventail de poignées et de systèmes d'appui fixes et mobiles en mesure de satisfaire toutes les exigences. Le système Sicura, mis au point sur la base des plus récentes recherches en thème d'ergonomie, permet de surmonter en toute sécurité et liberté les barrières architectoniques.

Possibilité de les placer dans le secteur de la rééducation, des maisons de santé pour personnes âgées, dans le domaine des sanitaires, des maisons privés et des structures publiques.

Couverture traitée avec des poudres spéciales en résines époxy et polyester, antichoc, anti-égratignures et résistante aux substances désinfectantes.

Ein großes Angebot an Griffen, sowie festen und mobilen Stützsystemen, die allen Ansprüchen entsprechen. Das auf neusten ergonomischen Untersuchungen basierende Sicura System bietet Sicherheit und Unabhängigkeit von architektonischen Barrieren. Es kann für den Rehasektor, Altersheime, Sanitäreinrichtungen, Privathäuser und öffentliche Einrichtungen eingesetzt werden. Die mit Spezialpulver aus Epoxyd- und Polyesterharzen oberflächenbehandelte Serie aus Aluminium und Nylon ist schlagfest, kratzfest und gegen Desinfektionsmittel unempfindlich.

Un amplísimo programa de grilletes y de sistemas de apoyo fijos y de muebles capaces de satisfacer todas las exigencias. El sistema Sicura, puesto a punto basándose en las más recientes investigaciones en tema de ergonomía, ofrece seguridad y libertad de las barreras arquitectónicas. Posibilidad de introducción en el sector de la rehabilitación, en las clínicas para ancianos, en el campo de los sanitarios, en las casas privadas y en las estructuras públicas. Revestimiento tratado con polvos especiales de resinas epoxídicas y poliéster, antichoque, irrayable y no atacable por las sustancias desinfectantes.

Предлагаем широкий ассортимент поручней и опорных приспособлений, как съёмных, так и стационарных, отвечающих самым разнообразным требованиям. Система Sicura, разработанная с учётом последних достижений в области эргономики, обеспечивает безопасность при отсутствии капитальных ограждений. Она предназначена для использования в больничных и реабилитационных учреждениях, домах престарелых, жилых домах и помещениях общего пользования. При изготовлении используется алюминий и нейлон, а также покрытия, обработанные специальными эпоксидными и полиэфирными порошками, устойчивыми к механическому и химическому воздействиям.



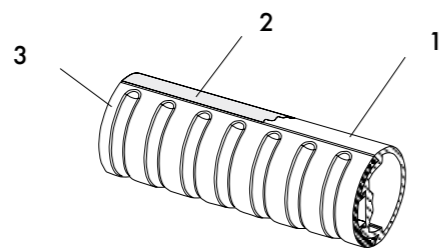

- ① 1 COPERTURA
- Trattata con polveri speciali in resine epossidiche e poliestere
 - Antiurto, antigraffio e non attaccabile dalle sostanze disinfettanti

- 2 PROFILO
- Profilo in lega speciale di alluminio-silicio-magnesio con eccellenti proprietà meccaniche
 - Altissima resistenza alla corrosione, ecc.

- 3 NYLON
- Nylon è un termine commerciale per il poliammide. Il materiale possiede qualità tali da renderlo adatto anche per la realizzazione di componenti tecniche. Viene dunque preferito per le sue proprietà e cioè:
 - resistenza alle rotture
 - resistenza all'abrasione
 - resistenza alle alte temperature
 - resistenza ai solventi ed ai prodotti chimici

- Ⓞ 1 COVERING
- treated with special epoxy resin and polyester powders
 - shockproof, scratch-proof and resistant to disinfectants

- 2 PROFILE
- Profile in special aluminium-silicon-magnesium alloy with excellent mechanical properties
 - very high resistance to corrosion

- 3 NYLON
- Nylon is a commercial term for polyamide. This material has qualities that make it suitable for producing technical components. It is therefore preferred because of its properties, i.e.:
 - resistance to breaking
 - resistance to abrasions
 - resistance to high temperatures
 - resistance to solvents and chemicals

- Ⓣ 1 COUVERTURE
- traité avec poudres spécifiques de résines époxydiques et polyester
 - antichoc, antirayures et entièrement résistant aux produits désinfectants

- 2 PROFIL
- Profil en alliage spécial aluminium-silicium-magnésium offrant d'excellentes propriétés mécaniques
 - très haute résistance à la corrosion

- 3 NYLON
- Nylon est l'appellation commerciale du polyamide. Ce matériau possède des qualités lui permettant d'être utilisé pour la réalisation des composants techniques:
 - résistance à la rupture
 - résistance à l'abrasion
 - résistance aux hautes températures
 - résistance aux solvants et aux produits chimiques

- Ⓛ 1 ABDECKUNG
- Mit Spezialpulver aus Epoxyharze und Polyester behandelt
 - Schlagfest, kratzfest und unempfindlich gegen Desinfektionsmittel

- 2 PROFIL
- Profil aus Aluminium-Silizium-Magnesium-Legierung mit hervorragenden mechanischen Eigenschaften
 - Extrem korrosionsfest

- 3 NYLON
- Nylon ist eine Handelsbezeichnung für Polyamid. Das Material besitzt Charakteristiken, die es zur Herstellung technischer Komponenten geeignet machen. Es wird wegen folgender Eigenschaften bevorzugt:
 - bruchfest
 - verschleißfest
 - temperaturunempfindlich
 - unempfindlich gegen Lösungsmittel und chemische Erzeugnisse

- Ⓧ 1 REVESTIMIENTO
- tratado con polvos especiales de resinas epoxídicas y poliéster
 - antichoque, resistente al rayado y no atacable por las sustancias desinfectantes

- 2 PERFIL
- Perfil de aleación especial de aluminio-silicio-magnesio con excelentes propiedades mecánicas
 - altísima resistencia a la corrosión

- 3 NYLON
- Nylon es un término comercial para la poliamida. El material posee calidades que hacen que sea adecuado también para la realización de componentes técnicos. Por lo tanto se prefiere por sus propiedades, es decir:
 - resistencia a las rupturas
 - resistencia a la abrasión
 - resistencia a las altas temperaturas
 - resistencia a los solventes y a los productos químicos

- Ⓡ 1 ПОКРЫТИЕ
- обработано специальными порошками из эпоксидных смол и полиэфира
 - противоударное, защищенное от царапин и не повреждаемое дезинфицирующими средствами

- 2 ПРОФИЛЬ
- профиль из специального сплава алюминия-кремния-магния с прекрасными механическими свойствами
 - высочайшая устойчивость к коррозии

- 3 НЕЙЛОН
- Нейлон – это коммерческий термин для обозначения полиамида. Этот материал обладает качествами, делающими его пригодным для изготовления технических компонентов. Его использование предпочтительно благодаря его свойствам:
 - устойчивость к поломкам
 - устойчивость к абразивному износу
 - устойчивость к высоким температурам
 - устойчивость к растворителям и химическим веществам

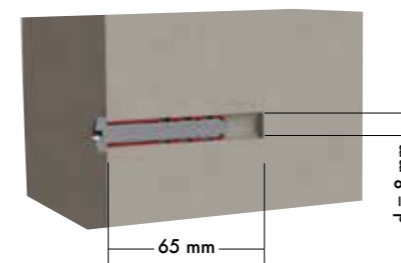

- Ⓛ FISSAGGIO STANDARD
- I seguenti accessori, adatti per il montaggio standard, sono inclusi:
- Tassello in nylon BF 8
 - Vite da legno 5,5 x 50 din 7981 - UNI 6954 adatta per calcestruzzo, mattoni pieni, mattoni forati
- Per pareti non comprese nelle tipologie sopraelencate, rivolgersi ad una ditta specializzata.

- Ⓞ STANDARD FIXING
- The following accessories, suitable for standing mounting, are included:
- 8 - BF nylon wall plugs
 - 5 - Wood screws - 5,5x50 din 7981 - UNI 6954 suitable for concrete, solid brick, hollow bricks, plasterboard
- For walls not included in the types listed above, apply to a specialist company.

- Ⓛ FIXATION STANDARD
- Les accessoires suivants, prévus pour un montage standard, sont inclus dans la fourniture:
- cheville en nylon BF 8
 - vis en bois 5,5x50 DIN 7981 - UNI 6954 prévue pour béton, briques pleines, briques perforées, placoplâtre
- En ce qui concerne les types de murs non énumérés plus haut, prière de s'adresser à une entreprise spécialisée.

- Ⓛ STANDARDBEFESTIGUNG
- Folgende für eine Standardmontage erforderliche Komponenten sind inbegriffen:
- Nylandübel BF 8
 - Holzschraube 5,5x50 DIN 7981 - UNI 6954 geeignet für Beton, Vollstein, Hohlstein, Rigips-Platten
- Für oben nicht aufgeführte Wandtypen ist sich an einen Fachbetrieb zu wenden

- Ⓧ FIJACIÓN ESTÁNDAR
- Están incluidos los siguientes accesorios, aptos para el montaje estándar:
- taco de nylon BF 8
 - tornillo de madera 5,5x50 din 7981 - UNI 6954 apto para hormigón, ladrillos llenos, ladrillos huecos, cartontabla
- Para paredes no incluidas en las tipologías aquí arriba mencionadas, dirigirse a una empresa especializada

- Ⓡ СТАНДАРТНАЯ ФИКСАЦИЯ
- Включены следующие принадлежности, подходящие для стандартного монтажа:
- нейлоновая пробка BF 8
 - винт для дерева 5,5x50 din 7981 - UNI 6954, подходящий для бетон, полнотелые кирпичи, пустотелые кирпичи, гипсокартон.
- Для стен, не включенных в данные типологии, указанные выше, следует обращаться в специализированную организацию

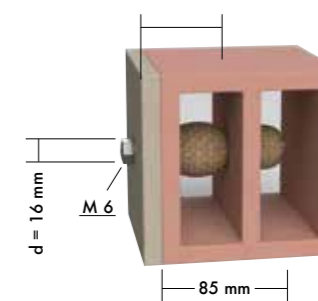

- Ⓛ FISSAGGIO SPECIALE
- Gli accessori sottoelencati per il fissaggio speciale devono essere acquistati in un negozio specializzato:
- ancorante chimico ad iniezione, mod. Fischer FIP 16
 - vite esagonale M 6 x 20 DIN 931 CNS
- Adatto per il fissaggio alle seguenti pareti:
- mattoni forati
 - mattoni in agglomerato precompresso
 - mattoni pieni

- Ⓞ SPECIAL FIXING
- The accessories listed below must be purchased in a specialist sales outlet:
- chemical hanger for injection, mod. Fischer FIP 16
 - hexagonal screws M 6x20 din 931 CNS
- Suitable for fixing to the following walls:
- hollow brick
 - pre-compressed briquette
 - solid brick

- Ⓛ FIXATION SPÉCIALE
- Les accessoires ci-dessous doivent être achetés dans un magasin spécialisé :
- agent d'ancrage chimique à injection, mod. Fischer FIP 16
 - vis hexagonale M 6x20 DIN 931 CNS
- Prévu pour fixation aux types de murs suivants :
- briques perforées
 - briques en aggloméré précontraint
 - briques pleines

- Ⓛ SPEZIALBEFESTIGUNG
- Das unten aufgeführte Material ist im Fachhandel erhältlich:
- Injektionsverankerung, Mod. Fischer FIP 16
 - Sechskantschraube M 6x20 DIN 931 CNS
- Für die Befestigung an folgenden Wänden geeignet:
- Hohlstein
 - Porenbeton
 - Vollstein

- Ⓧ FIJACIÓN ESPECIAL
- Los accesorios indicados aquí abajo tienen que ser comprados en una tienda especializada:
- fijador químico de inyección, mod. Fischer FIP 16
 - tornillo exagonal M 6x20 din 931 CNS
- Apto para la fijación a las siguientes paredes:
- ladrillos huecos
 - ladrillos de aglomerado pre-comprimido
 - ladrillos llenos

- Ⓡ СПЕЦИАЛЬНЫЙ КРЕПЕЖ
- Перечисленные ниже принадлежности должны быть приобретены в специализированном магазине:
- химический впрыскиваемый крепежитель, мод. Fischer FIP 16
 - шестигранный винт M 6x20 din 931 CNS
- подходит для фиксации на следующие стены:
- полнотелые кирпичи
 - кирпичи из восстановленного агломерата
 - дырчатые кирпичи

Maniglioni antiscivolo, con superfici prive di angoli -
 Non-slip handles, with smooth, rounded surfaces -
 Poignées antidérapantes, avec surfaces sans arêtes -
 Elemente mit rutschfesten Griffen und kantenlosen Oberflächen
 Grilletes antideslizantes, con superficies sin ángulos -
 Нескользящие поручни с округлой поверхностью



4800^①

60 x 18 x 70 cm

SGG **MIRALITE®REVOLUTION**
 Lo specchio ecologico by
 Eco friendly mirror by

**Specchio basculante infrangibile
 in resine termoplastiche/nylon**

Shatterproof tilting mirror in thermoplastic resins/nylon
 Miroir basculant infrangible en thermoplastique/nylon
 Neigbarer bruchsicherer Spiegel aus Kunststoff/nylon
 Espejo basculante irrompible de resinas termoplásticas/nylon
 Поворотное зеркало небьющееся
 из термопластичных смол и нейлона

① Non certificato TÜV - Not TÜV certified - Non certifié TÜV
 Nicht TÜV-geprüft - No certificado TÜV - Испытания
 на соответствие нормативу TÜV не проводились



4942

23 x 13 x 7 cm

**Lampada alogena per specchio 4800
 ottone/vetro/resine termoplastiche**

Lamp with halogen light for mirror 4800
 brass/glass/thermoplastic resins
 Applique avec lampe halogène pour miroir 4800
 laiton/verre/thermoplastique
 Leuchte mit Halogenlampe für Spiegel 4800
 Messing/Glas/Kunststoff
 Aplique con lámpara para espejo 4800
 latón/cristal/resinas termoplásticas
 Чнивeрсальная галотенная лаппа дпя зеркал 4800
 латунь/стекло/ термопластичная смоль

CE
 IP 23
 W75 - R7S

4840/25*

A 25 cm
 33 x 9 x 8 cm

4840/45

A 45 cm
 53 x 9 x 8 cm

4841/55

A 55 cm
 63 x 9 x 8 cm

4842/65

A 65 cm
 73 x 9 x 8 cm

* Articolo disponibile su richiesta - Item available on request
 Article disponible sur demande - Auf Anfrage erhältlich Artikel
 Artículo disponible bajo petición - Продукция, изготавливаемая
 по заказу

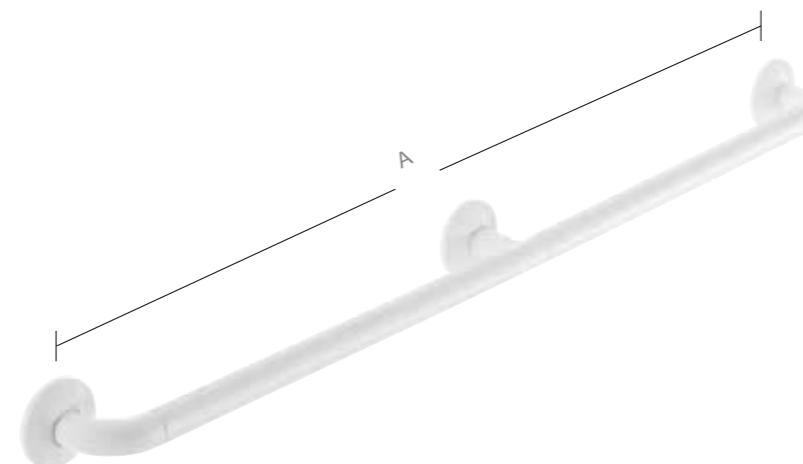

4843/10

A 105 cm
 113 x 9 x 8 cm

4844/11*

A 115 cm
 123 x 9 x 8 cm

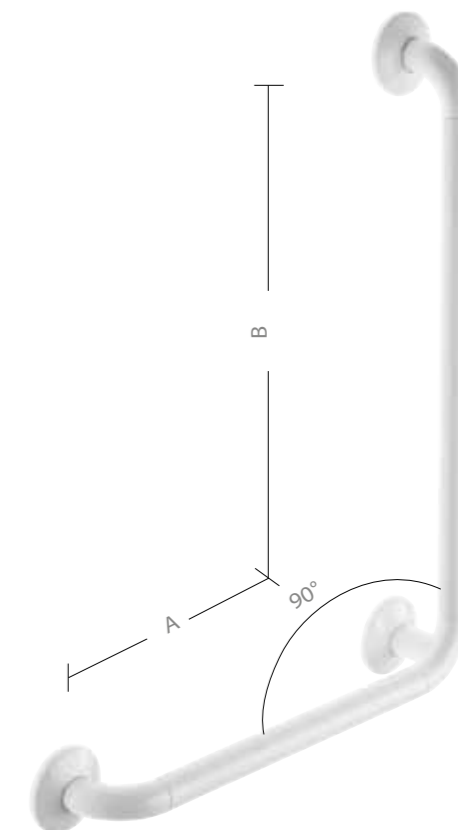

4848/44

A 45,5 cm
 B 60,5 cm
 52 x 9 x 67 cm

4849/44*

A 45,5 cm
 B 70,5 cm
 52 x 9 x 77 cm

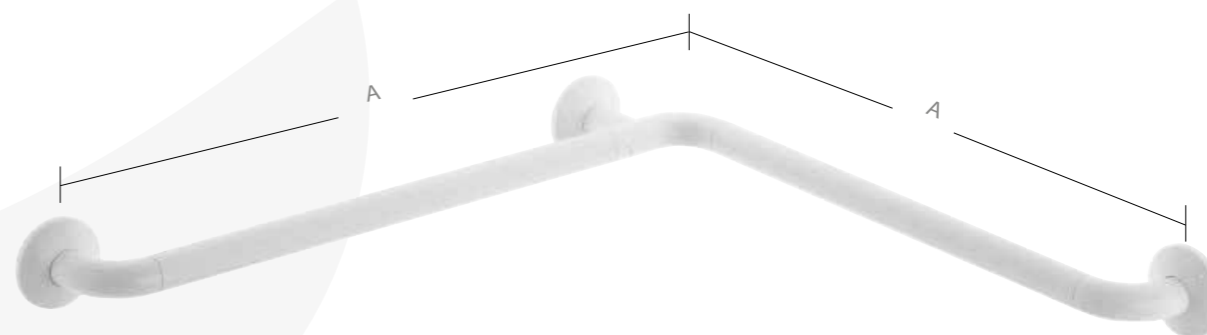

4854/77*

A 77 cm
 B 77 cm
 81 x 81 x 9 cm

* Articolo disponibile su richiesta - Item available on request
 Article disponible sur demande - Auf Anfrage erhältlich Artikel
 Artículo disponible bajo petición - Продукция, изготавливаемая
 по заказу

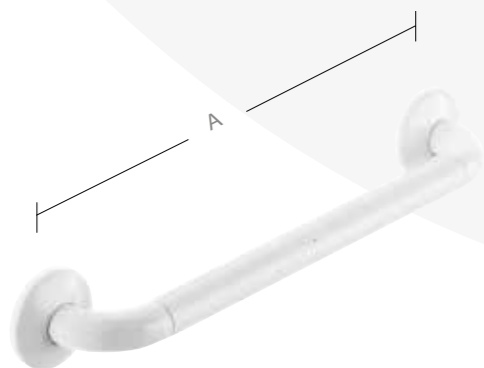

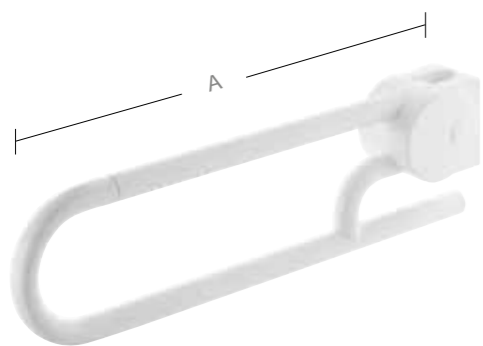

4857/64

A 64 x 9 x 18 cm

Meccanismo di ribaltamento in posizione orizzontale e verticale

Collapsible mechanism in horizontal and vertical position
 Mécanisme de basculement en position horizontale et verticale
 Kippmechanismus in waagerechter und in senkrechter Position
 Mecanismo de abatimiento en posición horizontal y vertical
 Откидной механизм в вертикальном и горизонтальном положении

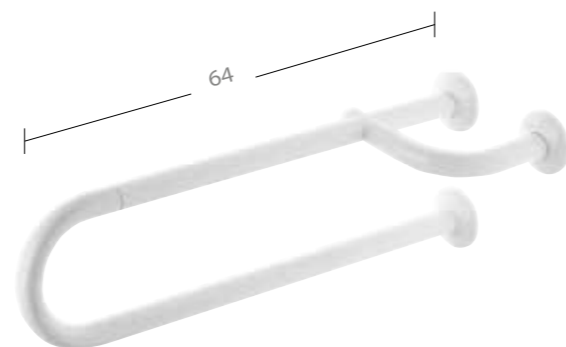

4858/74

A 74 x 9 x 18 cm

Reversibile

Reversible
 Réversible
 Reversibler
 Reversible
 Обратимый



A 64 x 24 x 18 cm



2283

34,5 x 34,5 x 10,5 cm

**Sedile ribaltabile per doccia
 resine termoplastiche/alluminio**

Shower seat - thermoplastic resins/aluminium
 Siège pour douche repliable - thermoplastique/aluminium
 Duschsitz hochklappbar - Kunststoff/Aluminium
 Asiento móvil para ducha - resinas termoplásticas/aluminio
 Сиденье для душа - термопластичные смолы/алюминий

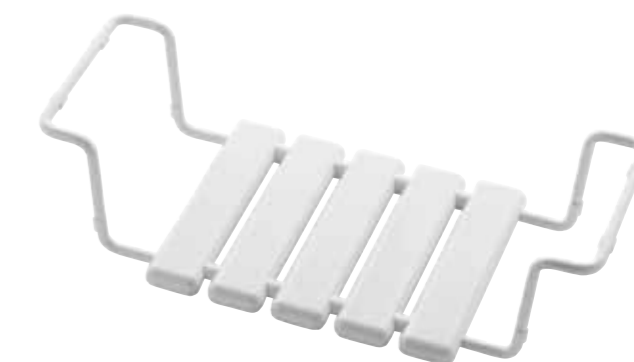

2284 ①

64 x 32,4 x 18,3 cm

**Sedile estensibile per vasca
 resine termoplastiche/alluminio**

Bath tub seat - thermoplastic resins/aluminium
 Siège pour baignoire - thermoplastique/aluminium
 Badewannensitz - Kunststoff/Aluminium
 Asiento para bañera - resinas termoplásticas/aluminio
 Раскладное сиденье для ванной
 термопластичные смолы/алюминий



Bracciali estensibili per vasche con misura interna di 50-65 cm
 Extendable arms for baths with internal measurement 50-65 cm
 Bras extensibles pour baignoires aux dimensions intérieures de 50-65 cm
 Verlängerbare Armlehnen für Wannen mit einem Innenmaß von 50-65 cm
 Apoyabrazos extensibles para bañeras con medidas interiores de 50-65 cm
 Выдвижные поручни для ванны, имеющей внутреннюю ширину от 50 до 65 см

① Non certificato TÜV - Not TÜV certified - Non certifié TÜV
 Nicht TÜV-geprüft - No certificado TÜV - Испытания
 на соответствие нормативу TÜV не проводились



4863*

23 x 14,5 x 60,5 cm



Maniglione per vasca. Adattabile a vasche con bordo da 6 cm a 12,5 cm

Safety handle for bath. Adaptable for bath-tubs with rims from 6 cm to 12,5 cm
 Barre de sûreté pour baignoire. Adaptable à baignoires avec bord de 6 cm à 12,5 cm
 Wanneneinsteighilfe. Verwendbar für Wannen mit einer Wandstärke von 6 cm bis 12,5 cm
 Asidero para bañera. Adaptable a bañeras con borde de 6 cm a 12,5 cm
 Двойной поручень на ванну. Устанавливается на ванны, имеющие стенку от 6 до 12,5 см

* Articolo disponibile su richiesta - Item available on request
 Article disponible sur demande - Auf Anfrage erhältlicher Artikel
 Artículo disponible bajo petición - Продукция, изготавливаемая по заказу



4880 - 9 x 9 x 8 cm

Angolo 90°
 Angle 90°
 Winkel 90°
 Angulo 90°
 Угол 90°



4883 - 15 x 9 x 9 cm

Angolo 90° con piede
 Angle 90° with foot
 Winkel 90° mit Fuß
 Angulo 90° con patas
 Угол 90° с ножкой



4881 - 11 x 9 x 8 cm

Angolo a T
 T-Angle
 T-Winkel
 Angulo a T
 Угол в форме T



4884 - 15 x 9 x 8 cm

Supporto con angolo 90°
 Support with angle 90°
 Befestigung mit Winkel 90°
 Soporte con angulo 90°
 Опора с углом 90°



4882 - 13 x 9 x 9 cm

Angolo 145° con piede
 Angle 145° with foot
 Winkel 145° mit Fuß
 Angulo 145° con patas
 Угол 145° с ножкой

4885 35 **4885 45** **4885 50**
 A 35 cm A 45 cm A 50 cm

4885 55 **4885 60**
 A 55 cm A 60 cm

Profilo anatomico - Profile tube with finger groove
 Profil anatomique - Profilrohr mit Fingerrillen
 Perfil aluminio con antideslizante - Анатомический профиль

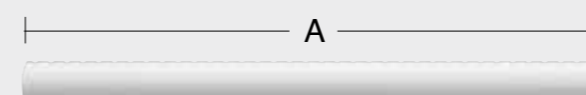



4894*^①

46,9 x 52,3 x 20,4 cm

Sedile ribaltabile con seduta liscia ergonomica

Smooth, ergonomic tilt-up shower seat
Siège pour douche repliable avec assise lisse ergonomique
Duschklapsitz mit glatter ergonomischer Sitzfläche
Asiento para ducha móvil con silla lisa ergonómica
Откидное сиденье с эргономичной гладкой поверхностью



4895*^①

43,8 x 53,2 x 46/53 cm

Sedile ribaltabile con seduta liscia ergonomica e supporto a pavimento

Ergonomic foldaway shower seat with floor support
Siège pour douche repliable avec assise lisse et support au sol
Duschklapsitz mit glatter Sitzfläche und Bodenstützern
Asiento para ducha móvil con silla lisa y soporte suelo
Откидное сиденье с гладкой поверхностью, опорой на полу



4896*^①

43,8 x 51,4 x 60,1 cm

Sedile con seduta liscia ergonomica agganciabile a maniglione

Hanging smooth shower seat for grab bar system
Siège pour douche avec assise lisse, accrochable à barre d'appui
Einhängesitz für Griffsystem mit glatter Sitzfläche
Asiento colgado para ducha con silla lisa ergonómica por el sistema de asideros
Сиденье с гладкой поверхностью, прицепляемое к рукоятке

* Articolo disponibile su richiesta - Item available on request
Article disponible sur demande - Auf Anfrage erhältlich Artikel
Artículo disponible bajo petición - Продукция, изготавливаемая по заказу

① Non certificato TÜV - Not TÜV certified - Non certifié TÜV
Nicht TÜV-geprüft - No certificado TÜV - Испытания на соответствие нормативу TÜV не проводились

Programma di maniglioni e sistemi d'appoggio fissi e mobili realizzato in acciaio zincato con verniciatura con polveri speciali in resine epossidiche e poliestere e attacchi in Ultraform®.

Range of handles and fixed and movable supporting systems made of zincated steel with covering treated with special epoxy and polyester resins and wall plates in Ultraform®.

Programme de poignées et de systèmes d'appui fixes et mobiles, réalisé en acier zingué avec laquage traité avec des poudres spéciales en résines époxy et polyester et plaques à mur en Ultraform®.

Serie von Griffen, sowie festen und mobilen Stützsystemen, hergestellt aus mit Spezialpulver aus Epoxyd- und Polyesterharzen oberflächenbehandeltem verzinkten Stahl mit Wandbefestigungen aus Ultraform®.

Programa de grilletes y de sistemas de apoyo fijos y de muebles realizado en acero galvanizado con revestimiento tratado con polvos especiales de resinas epoxídicas y poliéster y placas de pared en Ultraform®.

Ассортимент поручней и опорных приспособлений, как съёмных, так и стационарных, изготовлено из оцинкованной стали, а также покрытия, обработанные специальными эпоксидными и полиэфирными порошками и с плитками стены в Ultraform®.



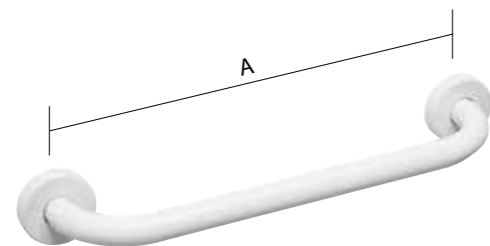

6421/30
37,5 x 11 x 7,5 cm - A=30

6421/45
52,5 x 11 x 7,5 cm - A=45

6421/60
67,5 x 11 x 7,5 cm - A=60

6421/90
97,5 x 11 x 7,5 cm - A=90



6490/00
A 36 x B 65 x 11 cm



6490/01
A 36 x B 65 x 11 cm

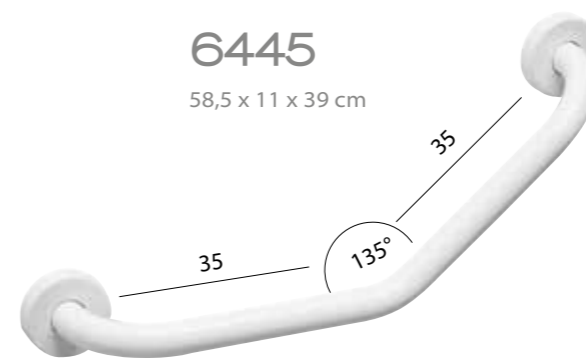

6445
58,5 x 11 x 39 cm



6466*
8,5 x 67 x 25 cm



6465*
8,5 x 67 x 25 cm



6450
7,5 x 16,5 x 187,5 cm

*** Meccanismo di ribaltamento in posizione orizzontale e verticale**
Collapsible mechanism in horizontal and vertical position
Mécanisme de basculement en position horizontale et verticale
Kippmechanismus in waagerechter und in senkrechter Position
Mecanismo de abatimiento en posición horizontal y vertical
Откидной механизм в вертикальном и горизонтальном положении

Elementi aggiuntivi componibili
 Additional elements
 Eléments supplémentaires
 Zusätzliche Elemente
 Elementos adicionales
 Комплектующие элементы для стенов

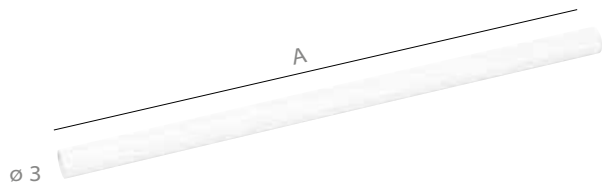

∅ 3

A

6470 6471 6472

A 30 cm 60 cm 90 cm



10

7,5

10

6473



10

12

12

6474

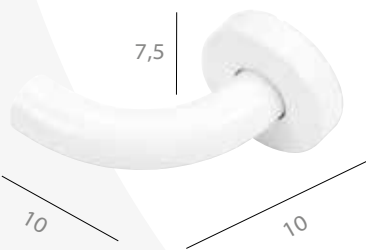

7,5

10

10

6475

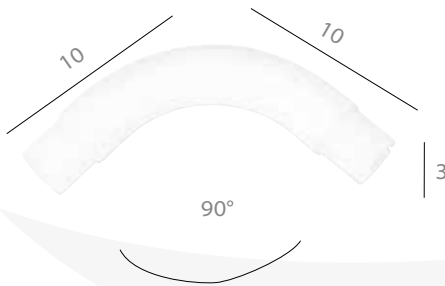

10

10

3

90°

6476

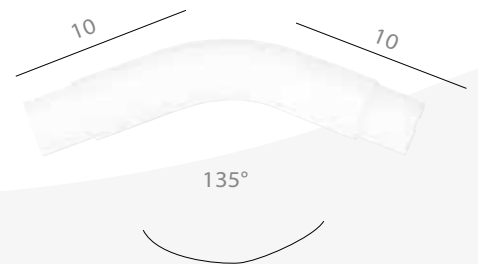

10

10

135°

6477

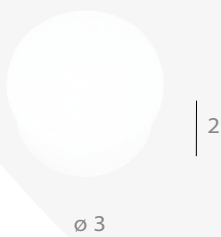

2

∅ 3

6478



4,8

∅ 3

6479



1,8

∅ 7,5

6481

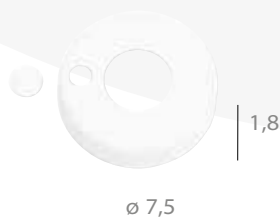

1,8

∅ 7,5

6482