

resol

**INSTALACIONES
FACILITIES
INSTALLATIONS**





NUESTRA HISTORIA

RESOL nació hace más de 55 años (1961), convirtiéndose desde entonces en un referente en el sector de la transformación del plástico a nivel estatal. Actualmente, el Grupo RESOL despunta como fabricante de productos plásticos de alto valor añadido en diseño, innovación y tecnología en combinación con otros materiales como el aluminio o el acero. A su vez, lidera los procesos de desarrollo, fabricación y comercialización de mobiliario y de accesorios de oficina.

Con vocación internacional, nuestros productos y servicios se encuentran presentes en más de 110 países alrededor del mundo, en los que exportamos más del 60% de nuestra producción. Contamos con la gama más amplia de mobiliario y accesorios para el sector de la Hostelería y la Oficina. Asimismo, somos líderes en productos para la Gran Distribución, Mobiliario de Diseño y Complementos de Oficina e Infraestructuras, a través de las marcas Barcelona Dd, Indecasa y Vilagrassa; en las cuales contamos con la colaboración de prestigiosos diseñadores internacionales como Josep Llusçà, Joan Gaspar, Jorge Pensi, David Carrasco Barceló, Joan Casas o Jordi Ribaudí.

OUR HISTORY

RESOL was founded over 55 years ago (1961), and became a reference in the plastics processing sector country wide. Today RESOL Group is known as a manufacturer of plastic products, in combination with other materials such as aluminum or steel, with high added value in design, innovation and technology. Is leading, in turn, the processes of development, production and marketing of indoor and outdoor furniture and office accessories.

Due to an international vocation, our products and services are present in more than 110 countries worldwide, exporting more than 60% of our production. We have the most extensive range of products for the Hospitality and Contract industry. We are also leaders in products for design furniture and mass distribution through our brands Barcelona Dd, Indecasa and Vilagrassa, with the collaboration of internationally renowned designers such as Josep Llusçà and Joan Gaspar, Jorge Pensi, David Carrasco Barceló, Joan Casas or Jordi Ribaudí.

NOTRE HISTOIRE

RESOL est né il y a plus de 55 ans (1961), devenant depuis lors une référence dans le secteur de la transformation du plastique à échelle nationale. Actuellement, le Groupe RESOL est reconnu comme fabriquant de produits plastiques de haute valeur ajoutée en design, innovation et technologie en combinaison avec d'autres matériaux comme l'aluminium ou l'acier. Il est aussi reconnu pour dominer les étapes de développement, fabrication et commercialisation du mobilier et d'accessoires de bureau.

Avec une orientation internationale, nos produits et services se trouvent présents dans plus de 110 pays dans le monde, où nous exportons plus de 60 % de notre production. Nous avons la gamme la plus vaste de mobilier et accessoires pour le secteur de l'hôtellerie et le bureau. Nous sommes également leader dans la grande distribution, le mobilier design et accessoires de bureau et infrastructures, à travers les marques Barcelona Dd, Indecasa et Vilagrassa. Nous comptons sur la collaboration de prestigieux designers internationaux comme Josep Llusçà, Joan Gaspar, Jorge Pensi, David Carrasco Barceló, Joan Casas et Jordi Ribaudí.

Más de 55 años compartiendo momentos, con la gama más extensa, los mejores precios y la máxima garantía

More than 55 years sharing moments, with the most extensive range of products, the best prices and the best guarantee

Plus de 55 ans partageant des moments, avec la plus large gamme, les meilleurs prix et la meilleure garantie

INSTALACIONES

Resol instalaciones es el catálogo de RESOL especializado en el mundo de la hostelería y las colectividades.

Nuestra amplia gama de productos, permite crear ambientes adecuados y únicos para hoteles, restaurantes, cafeterías, corporaciones, así como en los espacios destinados a eventos, tales como centros de banquetes y convenciones.

El diseño, la calidad, la durabilidad, la funcionalidad, la estética y la competitividad son las características principales que abanderan a nuestros productos.

Nuestra misión pasa por la innovación continua, la calidad y la eficacia en el servicio orientado a los profesionales de la hostelería y las colectividades.



FACILITIES

Resol facilities is the catalogue of RESOL specialized in the hotel and contract industry.

Our wide range of products, allows the creation of unique and optimal environments for hotels, restaurants, cafes, corporations, as well as for spaces dedicated to events such as banquets and conventions centers.

Design, quality, durability, functionality, aesthetics and competitive price are the main features that differentiate our products.

Our mission is based on continuous innovation, quality and effective service oriented to professionals in the hotel and contract industries.

Resol Installations est le catalogue spécialisé de RESOL dans le secteur de l'hôtellerie et des collectivités.

INSTALLATIONS

Notre large gamme de produits, permet la création d'environnements uniques et fonctionnels pour hôtels, restaurants, cafés, bureaux, ainsi que des espaces destinés aux événements tels que salles de banquet et conventions.

Le design, la qualité, la durabilité, la fonctionnalité, l'esthétique et les prix compétitifs sont les principales caractéristiques que réunissent nos produits.

Notre mission est l'innovation continue, la qualité et l'efficacité dans un service orienté aux professionnels de l'hôtellerie et des collectivités.



BARCELONA Dd

Barcelona Dd es una marca que se está consolidando como uno de los referentes en el mercado de mobiliario de diseño y es la apuesta de valor de Resol. Barcelona Dd ofrece mobiliario con un alto componente de diseño, fabricado principalmente en fibra de vidrio y polipropileno, en combinación con otros materiales como el aluminio, a precios muy competitivos. Para que esto sea posible, Barcelona Dd se apoya en los siguientes ejes estratégicos:

- Un equipo creativo formado por diseñadores de vanguardia que firman nuestros productos.
- Un parque industrial muy potente que integra un proceso propio de diseño, desarrollo y producción de nuevos productos.
- La utilización del sistema de inyección de plástico asistido por gas en el proceso productivo de los productos inyectados en fibra de vidrio con PP.

Barcelona Dd is a brand which is establishing itself as one of the leading brands in design furniture and it's the most ambitious stake of Resol for the future. Barcelona Dd offers stylish furniture made mainly in fiberglass and polypropylene, in combination with other materials as aluminium at highly competitive prices. In order to make it possible, Barcelona Dd is based on the following strategic pillars:

- A creative team made up of cuttingedge designers who develop our products.
- Consolidated industrial operations that integrate in-house processes of design, development and manufacturing of new products.
- The use of gas-injection technology in the manufacturing process of those products injected in fiberglass with PP.

Barcelona Dd est une marque qui s'affirme comme une référence sur le marché du mobilier design et qui constitue le défi ambitieux de Resol. Barcelona Dd propose un mobilier avec une composante créative élevée, conçu principalement en fibre de verre et polypropylène en combinaison avec des autres matériaux comme l'aluminium, avec des prix très compétitifs. Pour que cela soit possible, Barcelona Dd se base sur les axes stratégiques suivants:

- Une équipe créative formée de designers d'avant-garde qui développe nos produits.
- Un parc industriel très puissant intégrant un processus propre de conception, de développement et de production de nouveaux produits.
- L'utilisation du système d'injection de plastique assisté par gaz lors du processus productif avec ces produits injectés en fibre de verre et PP.

Barcelona Dd apuesta por el diseño. Barcelona Dd nace con la voluntad de crear un espacio en el que la creatividad pueda fluir con plena espontaneidad. Permite que los diseñadores se expresen con el máximo de libertad para aportar al mundo objetos útiles, prácticos, novedosos y bellos.

Diseñadores como Jorge Pensi, Josep Llusçà, Joan Gaspar o David Carrasco Barceló articulan lenguajes francamente diferenciados, aportando a Barcelona Dd una creatividad fresca y renovadora y el rigor de los creadores experimentados.

Barcelona Dd apuesta por el diseño como factor de diferenciación y competitividad clave. Esta inquietud le lleva a participar y promover diferentes acciones entorno a este eje. Entre ellas destaca su pertenencia a RED, Asociación de Empresas Españolas de Diseño, integrada por reconocidas compañías del sector.

Barcelona Dd is born with the desire to create a space where creativity flows with full spontaneity. It allows the designers to express themselves freely to present to the world useful, practical and beautiful, vanguard objects.

Designers like Jorge Pensi, Josep Llusçà, Joan Gaspar or David Carrasco Barceló transmit a variety of messages, contributing to Barcelona Dd's refreshing creativity, by respecting the rigor of experienced creators.

Barcelona Dd firmly believes that design is a key factor of differentiation and competitiveness. This conviction translates into the participation and promotion of different actions around this idea. Among these activities is its involvement with the Association of Spanish Companies of Design (RED), integrated by recognized companies of the industry.

—

Barcelona Dd s'engage pour le design. Barcelona Dd naît avec la volonté de créer un espace dans lequel la créativité coule avec une plénitude de spontanéité. Il permet aux créateurs de s'exprimer avec un maximum de liberté afin de présenter au monde des objets utiles, pratiques, innovatifs et esthétiques.

Des créateurs comme Jorge Pensi, Josep Llusçà, Joan Gaspar ou David Carrasco Barceló font passer leur message à leur manière, en apportant à Barcelona Dd une créativité fraîche ainsi que du renouvellement, tout en respectant la rigueur des créateurs expérimentés.

Barcelona Dd croit fermement que le design est un facteur clé de différenciation et de compétitivité. Cette conviction se matérialise par la participation et la promotion des différentes actions autour de cette idée. Une de ces activités est la participation à l'Association des entreprises espagnoles de design (RED), intégrée par des entreprises reconnues de l'industrie.

PREMIOS | AWARDS | PRIX



PEACH ARMCHAIR

Winner IIDA/HD Product Design Competition 2011
Las Vegas, USA.



TRAMA CHAIR AND ARMCHAIR

Winner IIDA/HD Product Design Competition 2011.
Las Vegas, USA.



NETKAT CHAIR AND ARMCHAIR

Award of Excellence IIDA/HD Product Design .
Competition 2012. Las Vegas, USA.



BEEKAT CHAIR AND ARMCHAIR

Platinum Award MIFF 2013.
Kuala Lumpur, Malaysia.



CLICK-CLACK SET

Platinum Award MIFF 2014.
Kuala Lumpur, Malaysia.

DISEÑADORES | DESIGNERS | CONCEPTEURS



JOSEP
LLUSCÀ



JOAN
GASPAR



JORGE
PENSI



DAVID
CARRASCO
BARCELÓ



FABRIZIO
BATONI



TON
HAAS

PREMIOS | AWARDS | PRIX



VELA TABLE

Award of Excellence IIDA/HD Product Design. Competition 2014. Las Vegas, USA.



BOOMERANG

HiP Winner, Awards at NeoCon Chicago, Estados Unidos

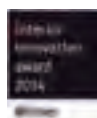

Interior Innovation Award 2014 Winner. Cologne, Germany.



JAN CHAIR COLLECTION AND JAN TABLE

IDA Design Awards Gold Winner 2017. Estados Unidos.
A'Design Award Winner 2018. Bronze.



SKIN

Gold Award MIFF 2015. Kuala Lumpur, Malaysia.



TOLEDO AIRE CHAIR

Delta de Plata prize at the 2018 ADI FAD Awards.

SILLAS Y SILLAS CON BRAZOS _____ **10**

CHAIRS AND ARMCHAIRS | CHAISES ET FAUTEUILS

MESAS _____ **126**

TABLES | TABLES

TABURETES _____ **164**

STOOLS | TABOURETS

SILLONES Y SOFÁS _____ **172**

ARMCHAIRS AND SOFAS | FAUTEUILS ET CANAPÉS

INFANTIL _____ **180**

KIDS | ENFANTS

SETS _____ **192**

SETS | SETS

TUMBONA Y MESA AUXILIAR _____ **200**

SUN LOUNGER AND SIDE TABLE | BAIN DE SOLEIL ET TABLE AUXILIAIRE

SILLAS Y SILLAS CON BRAZOS

CHAIRS AND ARMCHAIRS | CHAISES ET FAUTEUILS

SILLAS Y SILLAS CON BRAZOS |

CHAIRS AND ARMCHAIRS |

CHAISES ET FAUTEUILS

Tokyo	12	Bikini	44	Lama	82
Tokyo tapizada	14	Slatkat	46	Lama con brazos	83
Splash	16	Slatkat con brazos	47	Trama	86
Splash aire	18	Beekat	50	Trama con brazos	87
Woody	20	Beekat con brazos	51	Gina	90
Woody tapizada	21	Kat	54	Gina con brazos	91
Steely	22	Kat con brazos	55	Spot	94
Steely tapizada	23	Net-Kat	56	Fresh	96
Toledo Aire	26	Net-Kat con brazos	57	Fresh con brazos	97
Casino	28	Fiona	60	Wind	100
Click	30	Fiona con brazos	61	Wind con brazos	101
Wire	32	New Fiona	62	Elba	104
Wire con brazos	33	Fiona convenciones	64	Elba con brazos	105
Wire patín	34	Fiona combinaciones	66	Danna	106
Wire patín con brazos	35	Fiona New Fiona tapizada	67	Danna con brazos	107
Wire araña	38	Lisboa	68	Ona	110
Wire araña con brazos	39	Lisboa con brazos	69	Ona con brazos	111
Boss Soft	40	Lisboa tapizada	71	Julia	114
Boss	41	Peach	72	Pole deluxe	116
		Peach tapizada	73	Pole	117
		Neutra	76	Moon	120
		Neutra tapizada	77	Sun	121
		Carla	80	Seat Pad	124

TOKYO

JOSEP LLUSCÀ

Silla con brazos
Armchair
Fauteuil

 Apilable
8u. Stackable | Empilable

NEW

- Rojo | Red | Rouge
- Marfil | Ivory | Ivoire
- Gris Verdoso | Green-grey | Gris Vert
- Negro | Black | Noire
- Chocolate | Chocolate | Chocolat
- Toscano | Tuscan | Toscane
- Turquesa | Turquoise | Turquoise



Silla con brazos para uso interior y exterior. Fabricada en una sola pieza de polipropileno con fibra de vidrio mediante tecnología de moldeo asistida por gas. Apilable. Peso neto 3,6 kg.

Armchair for indoor and outdoor use. Produced as a single piece of injected polypropylene with fiberglass using gas assisted injection moulding technology. Stackable. Net weight 3,6 kg. (7.94 lb)

Fauteuil pour usage intérieur et extérieur. Produit en une seule pièce de polypropylène injecté avec fibre de verre en utilisant technologie de moulage assistée par gaz. Empilable. Poids net 3,6 kg.



W 55,5 cm	W 21.85 in
L 56,5 cm	L 22.24 in
H 79,5 cm	H 31.29 in
Hs 45,0 cm	Hs 17.71 in
Ha 65,5 cm	Ha 25.78 in

W: ancho / width / largeur. L: largo / length / longueur
H: altura / height / hauteur. Hs: altura asiento / seat height / hauteur du siège. Ha: altura brazo / arm height / hauteur du bras
Ø: diámetro / diameter / diamètre.

STD units	Packaging dim. (cm)	M3/ pack	NW units (kg)	Units Container 20'	Units Container 40'	Units Container HC	Units Truck 70m ³	Units Truck 100m ³
2	66,1x60,1x90	0,36	3,6	132	306	372	416	540
4	73,7x60,7x96,9	0,43	3,6	260	548	632	652	912
24	98x58x220	1,25	3,6	576	1152	1152	1296	1392



TOKYO TAPIZADA

JOSEP LLUSCÀ

Silla con brazos
Armchair
Fauteuil



Posibilidad de tapizar asiento y respaldo, o solamente el asiento.

Possibility of upholstering the seat and the backrest, or only the seat.

Possibilité de tapisser l'assise et le dossier, ou seulement l'assise.







































W 55,5 cm	W 21.85 in
L 56,5 cm	L 22.24 in
H 79,5 cm	H 31.29 in
Hs 45,0 cm	Hs 17.71 in
Ha 65,5 cm	Ha 25.78 in

W: ancho / width / largeur. L: largo / length / longueur
H: altura / height / hauteur. Hs: altura asiento / seat height / hauteur du siège. Ha: altura brazo / arm height / hauteur du bras
Ø: diámetro / diameter / diamètre.

STD units	Packaging dim. (cm)	M3/ pack	NW units (kg)	Units Container 20'	Units Container 40'	Units Container HC	Units Truck 70m³	Units Truck 100m³
2	66,1x60,1x90	0,36	5	132	306	372	416	540
4	73,7x60,7x96,9	0,43	5	260	548	632	652	912

TAPIZADO | UPHOLSTERED | REVÊTEMENT

	Rojo Red Rouge	Gris verdoso Green-grey Gris verdâtre	Marfil Ivory Ivore	Chocolate Chocolate Chocolat	Turquesa Turquoise Turquoise	Toscano Tuscan Toscan	Negro Black Noir
Calabaza Pumpkin Citrouille							
Lino Linen Lin							
Taupe Taupe Taupe							
Carbón Charcoal Charbon							
Mimosa Mimosa Mimosa							
Azul mineral Mineral blue Bleu minéral							
Negro Black Noir							

Tapizado apto para interiores y exteriores.
Composición Sunbrella®. Con espuma de secado rápido. Gramaje 275 gr/m².
Se ofrece la opción de tapizar solo el asiento.

Upholstery suitable for indoor and outdoor.
Composition Sunbrella®. With quick dry foam.
Grammage 275 gr/m².
The option of upholstering only the seat is offered.

Revêtement apte pour intérieur et extérieur.
Composition Sunbrella®. Mousse à séchage rapide. Textile 275 gr/m².
Option: possibilité de ne revêtir que l'assise

Ver instrucciones de mantenimiento en página 125
See maintenance instructions on page 125
Voir les instructions de maintenance à la page 125

SPLASH

JORGE PENSI

Silla con brazos
Armchair
Fauteuil

 Apilable
5u. Stackable | Empilable

- Blanco | White | Blanc
- Negro | Black | Noir
- Arena | Sand | Sable
- Gris Oscuro | Dark Grey | Gris Foncé
- Melocotón | Peach | Pêche
- Vainilla | Vanilla | Vanille
- Rojo | Red | Rouge

 Certificados | Certificates | Certificats

Splash chair Test Certificates:
EN 16139 L1 / EN 581 PUBLIC



Silla con brazos para uso interior y exterior. Asiento inyectado en polipropileno, con patas y brazos de tubo de aluminio extrusionado. Protección UV. Peso neto 3,20 kg.

Armchair for indoor and outdoor use. Seat injected with polypropylene. Arms and legs made in extruded aluminium. Stackable. UV protection. Net weight 3,20 kg (7.05 lb).

Fauteuil d'intérieur et extérieur. Siège injecté en polypropylène. Pieds et accoudoirs en aluminium extrudé. Empilable. Protection UV. Poids net 3,20 kg.

W 57 cm	W 22.44 in
L 54 cm	L 21.26 in
H 79 cm	H 31.10 in
Hs 45 cm	Hs 17.72 in
Ha 68 cm	Ha 26.77 in

W: ancho / width / largeur. L: largo / length / longueur
H: altura / height / hauteur. Hs: altura asiento / seat height / hauteur du siège. Ha: altura brazo / arm height / hauteur du bras
Ø: diámetro / diameter / diamètre.

STD units	Packaging dim. (cm)	M3/ pack	NW units (kg)	Units Container 20'	Units Container 40'	Units Container HC	Units Truck 70m ³	Units Truck 100m ³
2	66,1x60,1x90	0,36	3,2	132	306	372	416	540
4	73,7x60,7x96,9	0,43	3,2	260	548	632	652	912



SPLASH AIRE

JORGE PENSI

Silla con brazos
Armchair
Fauteuil

 Apilable
5u. Stackable | Empilable

NEW

- Azul Cielo | Light Blue | Bleu Ciel
- Toscano | Tuscan | Toscane
- Melocotón | Peach | Pêche
- Chocolate | Chocolate | Chocolat
- Marfil | Ivory | Ivoire
- Negro | Black | Noire



Silla con brazos para uso interior y exterior. Fabricada en una sola pieza de polipropileno con fibra de vidrio mediante tecnología de moldeo asistida por gas. Apilable. Peso neto 3,95 kg.

Armchair for indoor and outdoor use. Produced as a single piece of injected polypropylene with fiberglass using gas assisted injection moulding technology. Stackable. Net weight 3,95 kg. (8.70 lb)

Fauteuil pour usage intérieur et extérieur. Produit en une seule pièce de polypropylène injecté avec fibre de verre en utilisant technologie de moulage assistée par gaz. Empilable. Poids net 3,95 kg.

W 59,5 cm	W 23.42 in
L 52,5 cm	L 20.66 in
H 77 cm	H 30.31 in
Hs 43 cm	Hs 16.92 in
Ha 66,5 cm	Ha 25.98 in

W: ancho / width / largeur. L: largo / length / longueur
H: altura / height / hauteur. Hs: altura asiento / seat height / hauteur du siège. Ha: altura brazo / arm height / hauteur du bras
Ø: diámetro / diameter / diamètre.

STD units	Packaging dim. (cm)	M3/ pack	NW units (kg)	Units Container 20'	Units Container 40'	Units Container HC	Units Truck 70m³	Units Truck 100m³
2	66,1x60,1x90	0,36	3,95	132	306	372	416	540
4	73,7x60,7x96,9	0,43	3,95	260	548	632	652	912
17	120x58x220	1,25	3,95	272	640	640	736	864



Sillas Splash Aire (p. 18), mesa Vela S con HPL madera lavada (p. 142)

Splash Aire armchair (p. 18), table Vela S with HPL top in washed wood (p. 142)

Fauteuil Splash Aire (p. 18), table Vela S avec HPL bois delavé (p. 142)

WOODY

JOSEP LLUSCÀ

Silla con brazos
Armchair
Fauteuil

 Apilable
10u.Stackable | Empilable

- Gris Oscuro | Dark Grey | Gris Foncé
- Negro | Black | Noire
- Marfil | Ivory | Ivoire
- Arena | Sand | Sable
- Chocolate | Chocolate | Chocolat
- Azul Retro | Retro Bleu | Bleu Rétro
- Gris Verdoso | Green-grey | Gris Vert
- Rojo | Red | Rouge

 Certificados | Certificates | Certificats

Woody Test Certificates:
EN 16139 L1 / EN 581 PUBLIC



W 59 cm	W 23.22 in
L 74,20 cm	L 22.24 in
H 74,20cm	H 29.21 in
Hs 45 cm	Hs 17.71 in
Ha 67,2 cm	Ha 26.45 in



Silla con brazos para uso interior y exterior.
Inyectada en fibra de vidrio con PP. Apilable.
Protección UV. Peso neto 4,2 kg.

Armchair for indoor and outdoor use. Injected with
fiberglass and PP. Stackable. UV protection. Net
weight 4,2 kg (9.25 lb).

Fauteuil d'intérieur et extérieur. Injecté avec fibre de
verre et PP. Empilable. Protection UV. Poids net 4,2 kg.

W: ancho / width / largeur. L: largo / length / longueur
H: altura / height / hauteur. Hs: altura asiento / seat height /
hauteur du siège. Ha: altura brazo / arm height / hauteur du bras
Ø: diámetro / diameter / diamètre.

STD units	Packaging dim. (cm)	M3/ pack	NW units (kg)	Units Container 20'	Units Container 40'	Units Container HC	Units Truck 70m³	Units Truck 100m³
2	66,1x60,1x90	0,36	4,2	132	306	372	416	540
4	73,7x60,7x96,9	0,43	4,2	260	548	632	652	912
25	98x58x220	1,25	4,2	600	1.200	1.200	1.350	1.450

WOODY TAPIZADA

JOSEP LLUSCÀ

TAPIZADO
UPHOLSTERED
REVÊTEMENT

Composición / composition /
composition Sunbrella®

Con espuma de secado rápido / With quick
dry foam / Mousse à séchage rapide.

Tapizados aptos para interiores y exteriores
/ Upholstered suitable for indoor and
outdoor / Revêtement apte pour intérieur et
extérieur.

Gramaje / grammage /
grammage

275 gr / m2



	Arena Sand Sable	Gris oscuro Dark grey Gris foncé	Marfil Ivory Ivore	Chocolate Chocolate Chocolat	Gris verdoso Grey-green Gris vert	Azul retro retro blue bleu rétro	Rojo Red Rouge
Calabaza Pumpkin Citrouille							
Lino Linen Lin							
Taupe Taupe Taupe							
Carbón Charcoal Charbon							

Ver instrucciones de mantenimiento en página 125
See maintenance instructions on page 125
Voir les instructions de maintenance à la page 125

STEELY

JOSEP LLUSCÀ

Silla con brazos
Armchair
Fauteuil

 Apilable
10u. Stackable | Empilable

- Gris Oscuro | Dark Grey | Gris Foncé
- Marfil | Ivory | Ivoire
- Arena | Sand | Sable
- Chocolate | Chocolate | Chocolat
- Azul Retro | Retro Bleu | Bleu Rétro
- Rojo | Red | Rouge

 Certificados | Certificates | Certificats

Steely Test Certificates:
EN 16139 L1 / EN 581 PUBLIC



W 59 cm	W 23.23 in
L 56,50 cm	L 22.24 in
H 74,20 cm	H 29.21 in
Hs 45 cm	Hs 17.72 in
Ha 67,20 cm	Ha 26.46 in

W: ancho / width / largeur. L: largo / length / longueur
H: altura / height / hauteur. Hs: altura asiento / seat height / hauteur du siège. Ha: altura brazo / arm height / hauteur du bras
Ø: diámetro / diameter / diamètre.



Silla con brazos para uso interior y exterior.
Inyectada en fibra de vidrio con PP. Apilable.
Protección UV. Peso neto 4,2 kg.

Armchair for indoor and outdoor use. Injected with fiberglass and PP. Stackable. UV protection. Net weight 4,2 kg (9.25 lb).

Fauteuil d'intérieur et extérieur. Injecté avec fibre de verre et PP. Empilable. Protection UV. Poids net 4,2 kg.

STD units	Packaging dim. (cm)	M3/ pack	NW units (kg)	Units Container 20'	Units Container 40'	Units Container HC	Units Truck 70m³	Units Truck 100m³
2	66,1x60,1x90	0,36	4,2	132	306	372	416	540
4	73,7x60,7x96,9	0,43	4,2	260	548	632	652	912
25	98x58x220	1,25	4,2	600	1.200	1.200	1.350	1.450

STEELY TAPIZADA

JOSEP LLUSCÀ

TAPIZADO
UPHOLSTERED
REVÊTEMENT

Composición / composition /
composition Sunbrella®

Con espuma de secado rápido / With quick dry foam /
Mousse à séchage rapide.

Tapizados aptos para interiores y exteriores / Upholstered
suitable for indoor and outdoor / Revêtement apte pour
intérieur et extérieur.



Gramaje / grammage /
grammage
275 gr / m2

Posibilidad de tapizar
asiento y respaldo, o
solamente el asiento.

Possibility of upholstering
the seat and the backrest,
or only the seat.

Possibilité de tapisser
l'assise et le dossier, ou
seulement l'assise.

Ver instrucciones de
mantenimiento en página 125

See maintenance instructions
on page 125

Voir les instructions de
maintenance à la page 125

	Arena Sand Sable	Gris oscuro Dark grey Gris foncé	Marfil Ivory Ivore	Chocolate Chocolate Chocolat	Azul retro retro blue bleu rétro	Rojo Red Rouge
Calabaza Pumpkin Citrouille						
Lino Linen Lin						
Taupe Taupe Taupe						
Carbón Charcoal Charbon						



Sillas con brazos Woody y Steely (p. 20-22), mesa Corner con HPL roble natural (p. 148)

Steely and Woody armchairs (p. 20-22), Corner table with HPL top in natural oak (p. 148)

Fauteuils Steely et Woody (p. 20-22), table Corner avec HPL chêne naturel (p. 148)



TOLEDO AIRE

JORGE PENSI

Silla con brazos
Armchair
Fauteuil

 Apilable
6u. Stackable | Empilable

- Caldera | Red-orange | Orangé Rouge
- Marfil | Ivory | Ivoire
- Arena | sand | sable
- Chocolate | Chocolate | Chocolat
- Blanco | White | Blanc
- Gris Verdoso | Green-grey | Gris Vert



 Certificados | Certificates | Certificats

Toledo aire armchair Test Certificates:
EN 16139 L1 / EN 581 PUBLIC



W 56,1 cm	W 22.09 in
L 56,4 cm	L 22.20 in
H 77,7 cm	H 30.59 in
Hs 43,8 cm	Hs 17.24 in
Ha 68,4 cm	Ha 26.93 in

Silla con brazos para uso interior y exterior. Fabricada en una sola pieza de polipropileno con fibra de vidrio mediante tecnología de moldeo asistida por gas. Apilable. Peso neto 3,85 kg.

Armchair for indoor and outdoor use. Produced as a single piece of injected polypropylene with fiberglass using gas assisted injection moulding technology. Stackable. Net weight 3,85 kg (8.48lb).

Fauteuil pour usage intérieur et extérieur. Produit en une seule pièce de polypropylène injecté avec fibre de verre en utilisant technologie de moulage assistée par gaz. Empilable. Poids net 3,85 kg.

W: ancho / width / largeur. L: largo / length / longueur
H: altura / height / hauteur. Hs: altura asiento / seat height / hauteur du siège. Ha: altura brazo / arm height / hauteur du bras
Ø: diámetro / diameter / diamètre.

STD units	Packaging dim. (cm)	M3/ pack	NW units (kg)	Units Container 20'	Units Container 40'	Units Container HC	Units Truck 70m ³	Units Truck 100m ³
2	57x59,5x83	0,28	3,85	216	432	480	528	600
4	73,7x60,7x96,9	0,43	3,85	260	548	632	652	912
18	98x58x220	1,25	3,85	432	864	864	972	1.044

Silla con brazos Toledo Aire (p. 26), mesa Barcino (p. 146)

Toledo Aire armchair (p. 26), Barcino table (p. 146)

Toledo Aire fauteuil (p. 26), table Barcino (p. 146)



CASINO

JOAN GASPAR

Silla con brazos
Armchair
Fauteuil

 Apilable
8u. Stackable | Empilable

- Gris Oscuro | Dark Grey | Gris Foncé
- Marfil | Ivory | Ivoire
- Arena | Sand | Sable
- Chocolate | Chocolate | Chocolat
- Azul Retro | Retro Bleu | Bleu Rétro
- Gris Verdoso | Green-grey | Gris Vert



 Certificados | Certificates | Certificats

Casino chair Test Certificates:
EN 16139 L1 / EN 581 PUBLIC



W 73,80 cm	W 29.06 in
L 50 cm	L 19.69 in
H 73,80 cm	H 29.06 in
Hs 45,10 cm	Hs 17.76 in
Ha 72 cm	Ha 28.35 in

Silla con brazos para uso interior y exterior. Inyectada en fibra de vidrio con PP mediante tecnología de moldeo asistida por gas. Apilable. Protección UV. Peso neto 3,5 Kg.

Armchair for indoor and outdoor use. Injected with fiberglass and PP using gas assisted injection moulding technology. Stackable. UV protection. Net weight 3,5 kg (7.71 lb).

Fauteuil d'intérieur et extérieur. Injecté avec fibre de verre et PP, en utilisant technologie de moulage assistée par gaz. Empilable. Protection UV. Poids net 3,5 kg.

W: ancho / width / largeur. L: largo / length / longueur
H: altura / height / hauteur. Hs: altura asiento / seat height / hauteur du siège. Ha: altura brazo / arm height / hauteur du bras
Ø: diámetro / diameter / diamètre.

STD units	Packaging dim. (cm)	M3/ pack	NW units (kg)	Units Container 20'	Units Container 40'	Units Container HC	Units Truck 70m³	Units Truck 100m³
2	66,1x60,1x90	0,36	3,5	132	306	372	416	540
4	66,1x60,1x90	0,36	3,5	264	612	744	832	1.080
25	98x58x220	1,25	3,5	600	1.200	1.200	1.350	1.550



Silla con brazo Casino (p.28), mesa Core con HPL roble ceniza (p. 280)

Casino armchair (p.28), Core table with HPL top in ashen oak (p. 280)

Fauteuil Casino (p.28), table Corner avec HPL chêne cendré (p. 280)

CLICK WIRE

JOSEP LLUSCÀ

Silla
Chair
Chaise

CLICK WIRE

Estructura + asiento

Structure + seat

Structure + Siège

- Negro/Negro | Black/Black | Noir/Noir
- Gris Oscuro/Rojo | Dark Grey/Red | Gris Foncé/Rouge
- Marfil/Gris Verdoso | Ivory/Green-grey | Ivoire/Gris Vert
- Negro/Azul Retro | Black/Retro Bleu | Bleu Rétro/Noir/ Bleu Rétro
- Chocolate/ Blanco | Chocolate/ White | Chocolat/ Blanc



Silla con patas inyectadas en polipropileno con fibra de vidrio. Sistema de clipaje que permite combinarlas con el asiento del modelo WIRE. UV Protection.

Chair with injected polypropylene legs with fiberglass. Clipping system that allows to combine with the seat of the WIRE models.

Chaise avec pieds injectés en polypropylène avec fibre de verre. Système de clipsage qui permet de les combiner avec le siège des modèles WIRE. Protection UV.

📄 Certificados | Certificates | Certificats

Click Test Certificates:
EN 581-1 / EN 581-2 PUBLIC
EN 16139 L1



W 46 cm	W 18.11 in
L 48 cm	L 18.89 in
H 78,5 cm	H 30.90 in
Hs 46,5 cm	Hs 18.30 in

W: ancho / width / largeur. L: largo / length / longueur
H: altura / height / hauteur. Hs: altura asiento / seat height / hauteur du siège. Ha: altura brazo / arm height / hauteur du bras
Ø: diámetro / diameter / diamètre.

STD units	Packaging dim. (cm)	M3/ pack	NW units (kg)	Units Container 20'	Units Container 40'	Units Container HC	Units Truck 70m³	Units Truck 100m³
2	60x60x50	0,18	6,87	312	688	784	864	1.072



Sillas Click Wire (p.30) con mesa Neo (p. 254)

Click Wire chairs (p. 30) with Neo table (p. 254)

Chaise Click Wire (p. 30) avec table Neo (p. 254)

WIRE

JOSEP LLUSCÀ

Silla
Chair
Chaise

 Apilable
10u. Stackable | Empilable

- Negro | Black | Noire
- Blanco | White | Blanc
- Gris Verdoso | Green-grey | Gris Vert
- Rojo | Red | Rouge
- Azul Retro | Retro Bleu | Bleu Rétro



 Certificados | Certificats | Certificats

Wire chair Test Certificates:
EN 581-1 EN 581-2 PUBLIC
EN 16139 L1



W 51,70 cm	W 20.35 in
L 55,30 cm	L 21.77 in
H 77,70 cm	H 30.59 in
Hs 43 cm	Hs 16.93 in

Silla de cuatro patas para uso interior. Carcasa inyectada en fibra de vidrio y PP. Estructura de acero pintado. Apilable. Estructura y asiento del mismo color.

Four legs chair for indoor use. Seat injected with fiberglass and PP. Structure made of painted steel. Stackable. Structure and seat of the same colour.

Chaise 4 pieds pour usage intérieur. Siège injecté en fibre de verre et PP. Structure en acier peint blanc. Empilable. Structure et siège de même couleur.

W: ancho / width / largeur. L: largo / length / longueur
H: altura / height / hauteur. Hs: altura asiento / seat height / hauteur du siège. Ha: altura brazo / arm height / hauteur du bras
Ø: diámetro / diameter / diamètre.

STD units	Packaging dim. (cm)	M3/ pack	NW units (kg)	Units Container 20'	Units Container 40'	Units Container HC	Units Truck 70m³	Units Truck 100m³
2	66,1x60,1x90	0,36	4,91	132	306	372	416	540
4	74,2x51,7x96,1	0,36	4,91	312	624	768	748	996

WIRE

JOSEP LLUSCÀ

Silla con brazos
Armchair
Fauteuil

 Apilable
10u. Stackable | Empilable

- Negro | Black | Noire
- Blanco | White | Blanc
- Gris Verdoso | Green-grey | Gris Vert
- Rojo | Red | Rouge
- Azul Retro | Retro Bleu | Bleu Rétro

 Certificados | Certificates | Certificats

Wire armchair Test Certificates:
EN 581-1 EN 581-2 PUBLIC
EN 16139 L1



W 56 cm	W 22.05 in
L 54,40 cm	L 21.42 in
H 77,11 cm	H 30.36 in
Hs 43 cm	Hs 16.93 in
Ha 65,50 cm	Ha 25.79 in



Silla con brazos para uso interior. Carcasa inyectada en fibra de vidrio y PP. Estructura de acero pintado. Apilable. Estructura y asiento del mismo color.

Armchair for indoor use. Seat injected with fiberglass and PP. Structure made of painted steel. Stackable. Structure and seat of the same colour

Fauteuil 4 pieds pour usage intérieur. Siège injecté en fibre de verre et PP. Structure en acier peint. Empilable. Structure et siège de même couleur.

W: ancho / width / largeur. L: largo / length / longueur
H: altura / height / hauteur. Hs: altura asiento / seat height / hauteur du siège. Ha: altura brazo / arm height / hauteur du bras
Ø: diámetro / diameter / diamètre.

STD units	Packaging dim. (cm)	M3/ pack	NW units (kg)	Units Container 20'	Units Container 40'	Units Container HC	Units Truck 70m³	Units Truck 100m³
2	66,1x60,1x90	0,36	5,51	132	306	372	416	540
4	73,7X60,7X96,9	0,43	5,51	260	548	632	652	912

WIRE PATIN

JOSEP LLUSCÀ

Silla
Chair
Chaise

 Apilable
4u. Stackable | Empilable

- Negro | Black | Noire
- Blanco | White | Blanc
- Gris Verdoso | Green-grey | Gris Vert
- Rojo | Red | Rouge
- Azul Retro | Retro Bleu | Bleu Rétro

W 54 cm	W 21.25 in
L 52 cm	L 20.47 in
H 79 cm	H 31.10 in
Hs 43 cm	Hs 16.93 in



Silla patín para uso interior. Carcasa inyectada en fibra de vidrio y PP. Estructura de acero pintado. Apilable. Estructura y asiento del mismo color.

Sled base chair for indoor use. Seat injected with fiberglass and PP. Structure made of painted steel. Stackable. Structure and seat of the same colour.

Chaise patin pour usage intérieur. Siège injecté en fibre de verre et PP. Structure en acier peint. Empilable. Structure et siège de même couleur.

W: ancho / width / largeur. L: largo / length / longueur
H: altura / height / hauteur. Hs: altura asiento / seat height / hauteur du siège. Ha: altura brazo / arm height / hauteur du bras
Ø: diámetro / diameter / diamètre.

STD units	Packaging dim. (cm)	M3/ pack	NW units (kg)	Units Container 20'	Units Container 40'	Units Container HC	Units Truck 70m³	Units Truck 100m³
2	66,1x60,1x90	0,36	5,51	132	306	372	416	540
4	73,7X60,7X96,9	0,43	5,51	260	548	632	652	912

WIRE PATIN

JOSEP LLUSCÀ

Silla
Chair
Chaise

 Apilable
4u. Stackable | Empilable

- Negro | Black | Noire
- Blanco | White | Blanc
- Gris Verdoso | Green-grey | Gris Vert
- Rojo | Red | Rouge
- Azul Retro | Retro Bleu | Bleu Rétro

W 56 cm	W 22.05 in
L 52 cm	L 20.47 in
H 79 cm	H 31.10 in
Hs 43 cm	Hs 16.93 in
Ha 65,50 cm	Ha 25.79 in

Silla patín con brazos para uso interior. Carcasa inyectada en fibra de vidrio y PP. Estructura de acero pintado. Apilable. Estructura y asiento del mismo color

Sled base armchair for indoor use. Seat injected with fiberglass and PP. Structure made of steel. Stackable. Structure and seat of the same colour.

Fauteuil patin pour usage intérieur. Siège injecté en fibre de verre et PP. Structure en acier peint. Empilable. Structure et siège de même couleur.



W: ancho / width / largeur. L: largo / length / longueur
H: altura / height / hauteur. Hs: altura asiento / seat height / hauteur du siège. Ha: altura brazo / arm height / hauteur du bras
Ø: diámetro / diameter / diamètre.

STD units	Packaging dim. (cm)	M3/ pack	NW units (kg)	Units Container 20'	Units Container 40'	Units Container HC	Units Truck 70m³	Units Truck 100m³
2	66,1x60,1x90	0,36	5,51	132	306	372	416	540
4	73,7X60,7X96,9	0,43	5,51	260	548	632	652	912



Silla con brazos Wire araña y silla Wire patín (p. 39, 34)

Wire spider armchair and Wire sled base chair (p. 39, 34)

Fauteuil araignée Wire et Wire patin chaise (p. 39, 34)



WIRE ARAÑA

JOSEP LLUSCÀ

Silla
Chair
Chaise

- Negro | Black | Noire
- Blanco | White | Blanc
- Gris Verdoso | Green-grey | Gris Vert
- Rojo | Red | Rouge
- Azul Retro | Retro Bleu | Bleu Rétro

W 49 cm	W 19.29 in
L 53,4 cm	L 21.02 in
H 77,5 cm	H 30.51 in
Hs 43,7 cm	Hs 17.20 in



Silla araña para uso interior. Carcasa inyectada en fibra de vidrio y PP. Estructura de acero pintado. Estructura y asiento del mismo color.

Spider chair for indoor use. Seat injected with fiberglass and PP. Structure made of steel. Structure and seat of the same colour.

Chaise 4 pieds araignée pour usage intérieur. Siège injecté en fibre de verre et PP. Structure en acier peint. Structure et siège de même couleur.

W: ancho / width / largeur. L: largo / length / longueur
H: altura / height / hauteur. Hs: altura asiento / seat height /
hauteur du siège. Ha: altura brazo / arm height / hauteur du bras
Ø: diámetro / diameter / diamètre.

STD units	Packaging dim. (cm)	M3/ pack	NW units (kg)	Units Container 20'	Units Container 40'	Units Container HC	Units Truck 70m³	Units Truck 100m³
2	60x60x50	0,18	6,87	312	688	784	864	1.072

WIRE ARAÑA

JOSEP LLUSCÀ

Silla con brazos
Armchair
Fauteuil

- Negro | Black | Noire
- Blanco | White | Blanc
- Gris Verdoso | Green-grey | Gris Vert
- Rojo | Red | Rouge
- Azul Retro | Retro Bleu | Bleu Rétro

W 56 cm	W 22.05 in
L 53,4 cm	L 21.02 in
H 77,5 cm	H 30.51 in
Hs 43,7 cm	Hs 17.20 in
Ha 65,5 cm	Ha 25.79 in



Silla araña con brazos para uso interior. Carcasa inyectada en fibra de vidrio y PP. Estructura de acero pintado. Estructura y asiento del mismo color.

Spider armchair for indoor use. Seat injected with fiberglass and PP. Structure made of steel. Structure and seat of the same colour.

Fauteuil 4 pieds araignée pour usage intérieur. Siège injecté en fibre de verre et PP. Structure en acier peint. Structure et siège de même couleur.

W: ancho / width / largeur. L: largo / length / longueur
H: altura / height / hauteur. Hs: altura asiento / seat height /
hauteur du siège. Ha: altura brazo / arm height / hauteur du bras
Ø: diámetro / diameter / diamètre.

STD units	Packaging dim. (cm)	M3/pack	NW units (kg)	Units Container 20'	Units Container 40'	Units Container HC	Units Truck 70m³	Units Truck 100m³
2	60x60x50	0,18	7,48	312	688	784	864	1.072

BOSS SOFT

JOAN GASPAR

Silla con brazos
Armchair
Fauteuil

Estructura | Structure | Structure

Blanco | White | Blanc

Arena | Sand | Sable

Chocolate | Chocolate | Chocolat

Tejido | Estructura

Seat + Structure | Assise + Structure

Azul/Blanco | Blue/White | Bleu/Blanc

Beige/Chocolate | Beige/Chocolate | Beige/Chocolat

Beige/Arena | Beige/Sand | Beige/Sable



Silla plegable para uso interior y exterior. Inyectado en polipropileno con fibra de vidrio. Protección UV. Peso neto 5 kg. Tapizado apto para interiores y exteriores. Composición Sunbrella®. Con espuma de secado rápido.

Folding chair for indoor and outdoor use. Injected in polypropylene with fiberglass. UV protection. Net weight 5 kg (11.02 lb). Upholstery suitable for indoor and outdoor. Composition Sunbrella®. With quick dry foam.

Chaise pliante d'intérieur et extérieur. Injecté en polypropylène avec fibre de verre. Protection UV. Poids net 5 kg. Revêtement apte pour intérieur et extérieur. Composition Sunbrella®. Mousse à séchage rapide.

Ver instrucciones de mantenimiento en página 125

See maintenance instructions on page 125

Voir les instructions de

maintenance à la page 125

W 53,5 cm	W 21.06 in
L 49,0 cm	L 19.29 in
H 85,0 cm	H 33.46 in
Hs 47,0 cm	Hs 18.50 in
Ha 60,5 cm	Ha 23.81 in

W: ancho / width / largeur. L: largo / length / longueur
H: altura / height / hauteur. Hs: altura asiento / seat height / hauteur du siège. Ha: altura brazo / arm height / hauteur du bras
Ø: diámetro / diameter / diamètre.

STD units	Packaging dim. (cm)	M3/pack	NW units (kg)	Units Container 20'	Units Container 40'	Units Container HC	Units Truck 70m³	Units Truck 100m³
2	60x55x22	0,06	5	850	1752	2008	2680	2842

BOSS

JOAN GASPAR

Silla con brazos
Armchair
Fauteuil

⌘ Estructura | Structure | Structure

- Blanco | White | Blanc
- Arena | Sand | Sable
- Chocolate | Chocolate | Chocolat

⊠ Textilene | Textilene | Textilène

- Blanco | White | Blanc
- Beige | Beige | Beige
- Chocolate | Chocolate | Chocolat
- Azul | Blue | Bleu

📄 Certificados | Certificates | Certificats

Boss chair Test Certificates:
EN 581 PUBLIC / EN 16139 L1



Silla plegable para uso interior y exterior. Inyectado en polipropileno con fibra de vidrio. Protección UV. Peso neto 5 kg. Textilene de 850 gr.

Folding chair for indoor and outdoor use. Injected in polypropylene with fiberglass. UV protection. Net weight 5 kg (11.02 lb). Textilene 850 gr.

Chaise pliante d'intérieur et extérieur. Injecté en polypropylène avec fibre de verre. Protection UV. Poids net 5 kg. Textilène 850 gr.

W 53,5 cm	W 21.06 in
L 49 cm	L 19.29 in
H 85 cm	H 33.46 in
Hs 47 cm	Hs 18.50 in
Ha 60,5 cm	Ha 23.82 in

W: ancho / width / largeur. L: largo / length / longueur
H: altura / height / hauteur. Hs: altura asiento / seat height / hauteur du siège. Ha: altura brazo / arm height / hauteur du bras
Ø: diámetro / diameter / diamètre.

STD units	Packaging dim. (cm)	M3/pack	NW units (kg)	Units Container 20'	Units Container 40'	Units Container HC	Units Truck 70m ³	Units Truck 100m ³
2	60x55x22	0,06	5	850	1.752	2.008	2.680	2.842



Silla con brazos Boss (p.41), mesa Barcino pie central color arena (p. 134)

Armchair Boss (p.41), pedestal base table Barcino (p.134)

42 Boss fauteuil (p.41), Barcino table pied central (p.134)



BIKINI

JORGE PENSI

Silla
Chair
Chaise

 Apilable
5u. Stackable | Empilable

- Blanco | White | Blanc
- Negro | Black | Noir
- Arena | Sand | Sable
- Gris Oscuro | Dark Grey | Gris Foncé
- Melocotón | Peach | Pêche
- Rojo | Red | Rouge

 Certificados | Certificates | Certificats

Bikini chair Test Certificates:
EN 16139 L1 / EN 581 PUBLIC



Silla para uso interior y exterior. Asiento inyectado en polipropileno. Patas de tubo de acero pintado con tratamiento anti-óxido. Apilable. Protección UV. Peso neto 5,46 kg.

Chair for indoor and outdoor use. Seat injected with polypropylene. Legs made in painted Steel with antirust treatment. Stackable. UV protection. Net weight 5,46 kg (12.04 lb).

Chaise d'intérieur et extérieur. Siège injecté en polypropylène. Pieds fabriqués en acier peint avec un traitement anti-rouille. Empilable. Protection UV. Poids net 5,46 kg.

W 44 cm	W 17.32 in
L 53 cm	L 20.87 in
H 81 cm	H 31.89 in
Hs 45 cm	Hs 17.72 in

W: ancho / width / largeur. L: largo / length / longueur
H: altura / height / hauteur. Hs: altura asiento / seat height / hauteur du siège. Ha: altura brazo / arm height / hauteur du bras
Ø: diámetro / diameter / diamètre.

STD units	Packaging dim. (cm)	M3/ pack	NW units (kg)	Units Container 20'	Units Container 40'	Units Container HC	Units Truck 70m ³	Units Truck 100m ³
2	66,1x60,1x90	0,36	5,46	132	306	372	416	540
4	73,7x60,7x96,9	0,43	5,46	260	548	632	652	912



SLATKAT

JOSEP LLUSCÀ

Silla
Chair
Chaise

 Apilable
10u. Stackable | Empilable

- Blanco | White | Blanc
- Arena | Sand | Sable
- Chocolate | Chocolate | Chocolat
- Azul Retro | Retro Bleu | Bleu Rétro
- Gris Verdoso | Green-grey | Gris Vert
- Rojo | Red | Rouge



 Certificados | Certificates | Certificats

Slatkat chair Test Certificates:
EN 581-1 EN 581-2 PUBLIC
EN 16139 L1



Silla para uso interior y exterior. Inyectada en fibra de vidrio con PP mediante tecnología de moldeo asistida por gas. Apilable. Protección UV. Peso neto 3,6 kg.

Chair for indoor and outdoor use. Injected with fiberglass and PP using gas assisted injection moulding technology. Stackable. UV protection. Net weight 3,6 kg (7.93 lb).

Chaise d'intérieur et extérieur. Injecté avec fibre de verre et PP, en utilisant technologie de moulage assistée par gaz. Empilable. Protection UV. Poids net 3,6 kg.

W 49 cm	W 19.29 in
L 54,50 cm	L 21.46 in
H 79 cm	H 31.10 in
Hs 45 cm	Hs 17.72 in

W: ancho / width / largeur. L: largo / length / longueur
H: altura / height / hauteur. Hs: altura asiento / seat height / hauteur du siège. Ha: altura brazo / arm height / hauteur du bras
Ø: diámetro / diameter / diamètre.

STD units	Packaging dim. (cm)	M3/ pack	NW units (kg)	Units Container 20'	Units Container 40'	Units Container HC	Units Truck 70m³	Units Truck 100m³
2	66,1x60,1x90	0,36	3,6	132	306	372	416	540
4	74,2x51,7x96,9	0,37	3,6	312	624	768	748	996
23	98x58x220	1,25	3,6	552	1.104	1.104	1.242	1.334

SLATKAT

JOSEP LLUSCÀ

Silla con brazos
Armchair
Fauteuil

 Apilable
10u. Stackable | Empilable

- Blanco | White | Blanc
- Arena | Sand | Sable
- Chocolate | Chocolate | Chocolat
- Azul Retro | Retro Bleu | Bleu Rétro
- Gris Verdoso | Green-grey | Gris Vert
- Rojo | Red | Rouge

 Certificados | Certificates | Certificats
Slatkat armchair Test Certificates:
EN 581-1 EN 581-2 PUBLIC
EN 16139 L1



Silla con brazos para uso interior y exterior.
Inyectada en fibra de vidrio con PP mediante
tecnología de moldeo asistida por gas. Apilable.
Protección UV. Peso neto 4,1 kg.

Armchair for indoor and outdoor use. Injected with
fiberglass and PP using gas assisted injection
moulding technology. Stackable. UV protection. Net
weight 4,1 kg (9.03 lb).

Fauteuil d'intérieur et extérieur. Injecté avec fibre de verre
et PP, en utilisant technologie de moulage assistée par
gaz. Empilable. Protection UV. Poids net 4,1 kg.

W 49 cm	W 19.29 in
L 54,5 cm	L 21.46 in
H 78,2 cm	H 31.10 in
Hs 45 cm	Hs 17.72 in

W: ancho / width / largeur. L: largo / length / longueur
H: altura / height / hauteur. Hs: altura asiento / seat height /
hauteur du siège. Ha: altura brazo / arm height / hauteur du bras
Ø: diámetro / diameter / diamètre.

STD units	Packaging dim. (cm)	M3/ pack	NW units (kg)	Units Container 20'	Units Container 40'	Units Container HC	Units Truck 70m³	Units Truck 100m³
2	66,1x60,1x90	0,36	4,1	132	306	372	416	540
4	73,7x60,7x96,9	0,43	4,1	260	548	632	652	912
23	98x58x220	1,25	4,1	552	1.104	1.104	1.242	1.334

Silla Slatkat con brazos y silla Slatkat (p. 46-47), mesa Vela M con sobre de cristal templado (p. 144)
Slatkat armchair and Slatkat chair (p. 46-47), Vela M table with tempered glass top (p. 144)
Fauteuil Slatkat et chaise Slatkat (p. 46-47), table Vela M avec verre trempé plateaux (p. 144)





BEEKAT

JOSEP LLUSCÀ

Silla
Chair
Chaise

 Apilable
10u. Stackable | Empilable

- Blanco | White | Blanc
- Chocolate | Chocolate | Chocolat
- Verde Oliva | Olive Green | Vert Olive
- Rojo | Red | Rouge
- Arena | sand | sable



 Certificados | Certificates | Certificats

Beekat chair Test Certificates:
EN 581 PUBLIC



Silla para uso interior y exterior. Inyectada en fibra de vidrio con PP mediante tecnología de moldeo asistida por gas. Apilable. Protección UV. Peso neto 3,70 kg.

Chair for indoor and outdoor use. Injected with fiberglass and PP using gas assisted injection moulding technology. UV protection. Stackable. Net weight 3,70 kg (8.16 lb).

Chaise pour usage intérieur et extérieur. Injectée avec fibre de verre et PP, en utilisant technologie de moulage assistée par gaz. Protection UV. Empilable. Poids net 3,70 kg.

W 50,5 cm | W 19.88 in
L 55,5 cm | L 21.85 in
H 79 cm | H 31.10 in
Hs 47 cm | Hs 18.50 in

W: ancho / width / largeur. L: largo / length / longueur
H: altura / height / hauteur. Hs: altura asiento / seat height / hauteur du siège. Ha: altura brazo / arm height / hauteur du bras
Ø: diámetro / diameter / diamètre.

STD units	Packaging dim. (cm)	M3/ pack	NW units (kg)	Units Container 20'	Units Container 40'	Units Container HC	Units Truck 70m³	Units Truck 100m³
2	66,1x60,1x90	0,36	3,7	132	306	372	416	540
4	74,2x51,7x96,9	0,37	3,7	312	624	768	748	996
23	98x58x220	1,25	3,7	552	1.104	1.104	1.242	1.334

BEEKAT

JOSEP LLUSCÀ

Silla con brazos
Armchair
Fauteuil

 Apilable
10u. Stackable | Empilable

- Blanco | White | Blanc
- Chocolate | Chocolate | Chocolat
- Verde Oliva | Olive Green | Vert Olive
- Rojo | Red | Rouge
- Arena | sand | sable



 Certificados | Certificates | Certificats
Beekat armchair Test Certificates:
EN 581 PUBLIC



Silla con brazos para uso interior y exterior.
Inyectada en fibra de vidrio con PP mediante
tecnología de moldeo asistida por gas. Apilable.
Protección UV. Peso neto 4,20 kg.

Armchair for indoor and outdoor use. Injected with
fiberglass and PP using gas assisted injection
moulding technology. Stackable. UV protection.
Net weight 4,20 kg (9.26 lb).

Fauteuil pour usage intérieur et extérieur. Injecté
avec fibre de verre et PP, en utilisant technologie de
moulage assistée par gaz. Empilable. Protection UV.
Poids net 4,20 kg.

W 56 cm	W 22.05 in
L 55,5 cm	L 21.85 in
H 79 cm	H 31.10 in
Hs 47 cm	Hs 18.50 in
Ha 65,5 cm	Ha 25.79 in

W: ancho / width / largeur. L: largo / length / longueur
H: altura / height / hauteur. Hs: altura asiento / seat height /
hauteur du siège. Ha: altura brazo / arm height / hauteur du bras
Ø: diámetro / diameter / diamètre.

STD units	Packaging dim. (cm)	M3/ pack	NW units (kg)	Units Container 20'	Units Container 40'	Units Container HC	Units Truck 70m³	Units Truck 100m³
2	66,1x60,1x90	0,36	4,20	132	306	372	416	540
4	73,7x60,7x96,9	0,43	4,20	260	548	632	652	912
23	98x58x220	1,25	4,20	552	1.104	1.104	1.242	1.334





Sillas y sillas con brazos Beekat (p. 50-51) mesa Barcino (p. 146)

Sillas y sillas con brazos Beekat (p. 50-51) mesa Barcino (p. 146)

Chaises et fauteuils Beekat (p. 50-51) table Barcino (p. 146)

KAT

JOSEP LLUSCÀ

Silla
Chair
Chaise

 Apilable
10u. Stackable | Empilable

- Blanco | White | Blanc
- Chocolate | Chocolate | Chocolat
- Verde Oliva | Olive Green | Vert Olive
- Rojo | Red | Rouge
- Arena | sand | sable



 Certificados | Certificates | Certificats

Kat chair Test Certificates:
EN 581 PUBLIC



Silla para uso interior y exterior. Inyectada en fibra de vidrio con PP mediante tecnología de moldeo asistida por gas. Apilable. Protección UV. Peso neto 3,70 kg.

Chair for indoor and outdoor use. Injected with fiberglass and PP using gas assisted injection moulding technology. Stackable. UV protection. Net weight 3,70 kg (8.16 lb).

Chaise pour usage intérieur et extérieur. Injectée avec fibre de verre et PP, en utilisant technologie de moulage assistée par gaz. Empilable. Protection UV. Poids net 3,70 kg.

W 50,5 cm	W 19.88 in
L 55,5 cm	L 21.85 in
H 79 cm	H 31.10 in
Hs 47 cm	Hs 18.50 in

W: ancho / width / largeur. L: largo / length / longueur
H: altura / height / hauteur. Hs: altura asiento / seat height / hauteur du siège. Ha: altura brazo / arm height / hauteur du bras
Ø: diámetro / diameter / diamètre.

STD units	Packaging dim. (cm)	M3/ pack	NW units (kg)	Units Container 20'	Units Container 40'	Units Container HC	Units Truck 70m³	Units Truck 100m³
2	66,1x60,1x90	0,36	3,7	132	306	372	416	540
4	74,2x51,7x96,9	0,37	3,7	312	624	768	748	996
23	98x58x220	1,25	3,7	552	1.104	1.104	1.242	1.334

KAT

JOSEP LLUSCÀ

Silla con brazos
Armchair
Fauteuil



Apilable
10u. Stackable | Empilable

- Blanco | White | Blanc
- Chocolate | Chocolate | Chocolat
- Verde Oliva | Olive Green | Vert Olive
- Rojo | Red | Rouge
- Arena | sand | sable



Certificados | Certificates | Certificats

Kat armchair Test Certificates:
EN 581 PUBLIC



Silla con brazos para uso interior y exterior. Inyectada en fibra de vidrio con PP mediante tecnología de moldeo asistida por gas. Apilable. Protección UV. Peso neto 4,20 kg.

Armchair for indoor and outdoor use. Injected with fiberglass and PP using gas assisted injection moulding technology. Stackable. UV protection. Net weight 4,20 kg (9.26 lb).

Fauteuil d'intérieur et extérieur. Injecté avec fibre de verre et PP, en utilisant technologie de moulage assistée par gaz. Empilable. Protection UV. Poids net 4,20 kg.

W 56 cm	W 22.05 in
L 55,5 cm	L 21.85 in
H 79 cm	H 31.10 in
Hs 47 cm	Hs 18.50 in
Ha 65,5 cm	Ha 25.79 in

W: ancho / width / largeur. L: largo / length / longueur
H: altura / height / hauteur. Hs: altura asiento / seat height / hauteur du siège. Ha: altura brazo / arm height / hauteur du bras
Ø: diámetro / diameter / diamètre.

STD units	Packaging dim. (cm)	M3/ pack	NW units (kg)	Units Container 20'	Units Container 40'	Units Container HC	Units Truck 70m ³	Units Truck 100m ³
2	66,1x60,1x90	0,36	4,20	132	306	372	416	540
4	73,7x60,7x96,9	0,37	4,20	260	548	632	652	912
23	98x58x220	1,25	4,20	552	1.104	1.104	1.242	1.334

NET-KAT

JOSEP LLUSCÀ

Silla
Chair
Chaise

 Apilable
10u. Stackable | Empilable

- Blanco | White | Blanc
- Verde Oliva | Olive Green | Vert Olive
- Chocolate | Chocolate | Chocolat
- Negro | Black | Noir
- Arena | sand | sable



 Certificados | Certificates | Certificats
Net-kat chair Test Certificates:
EN 581 PUBLIC



Silla para uso interior y exterior. Inyectada en fibra de vidrio con PP mediante tecnología de moldeo asistida por gas. Apilable. Protección UV. Peso neto 3,60 kg.

Chair for indoor and outdoor use. Injected with fiberglass and PP using gas assisted injection moulding technology. Stackable. UV protection. Net weight 3,60 kg (7.93 lb).

Chaise d'intérieur et extérieur. Injectée avec fibre de verre et PP, en utilisant technologie de moulage assistée par gaz. Empilable. Protection UV. Poids net 3,60 kg.

W 50,5 cm	W 19.88 in
L 55,5 cm	L 21.85 in
H 79 cm	H 31.10 in
Hs 47 cm	Hs 18.50 in

W: ancho / width / largeur. L: largo / length / longueur
H: altura / height / hauteur. Hs: altura asiento / seat height /
hauteur du siège. Ha: altura brazo / arm height / hauteur du bras
Ø: diámetro / diameter / diamètre.

STD units	Packaging dim. (cm)	M3/ pack	NW units (kg)	Units Container 20'	Units Container 40'	Units Container HC	Units Truck 70m³	Units Truck 100m³
2	66,1x60,1x90	0,36	3,6	132	306	372	416	540
4	74,2x51,7x96,9	0,37	3,6	312	624	768	748	996
23	98x58x220	1,25	3,6	552	1.104	1.104	1.242	1.334

NET-KAT

JOSEP LLUSCÀ

Silla con brazos
Armchair
Fauteuil

 Apilable
10u. Stackable | Empilable

- Blanco | White | Blanc
- Verde Oliva | Olive Green | Vert Olive
- Chocolate | Chocolate | Chocolat
- Negro | Black | Noir
- Arena | sand | sable



 Certificados | Certificates | Certificats
Net-kat Armchair Test Certificates:
EN 581 PUBLIC



Silla con brazos para uso interior y exterior.
Inyectada en fibra de vidrio con PP mediante
tecnología de moldeo asistida por gas. Apilable.
Protección UV. Peso neto 4,10 Kg.

Armchair for indoor and outdoor use. Injected with
fiberglass and PP using gas assisted injection
moulding technology. Stackable. UV protection.
Net weight 4,10 kg. (9.03 lb).

Fauteuil d'intérieur et extérieur. Injecté avec fibre
de verre et PP, en utilisant technologie de moulage
assistée par gaz. Empilable. Protection UV. Poids
net 4,10 kg.

W 56 cm	W 22.05 in
L 55,5 cm	L 21.85 in
H 79 cm	H 31.10 in
Hs 47 cm	Hs 18.50 in
Ha 65,5 cm	Ha 25.79 in

W: ancho / width / largeur. L: largo / length / longueur
H: altura / height / hauteur. Hs: altura asiento / seat height /
hauteur du siège. Ha: altura brazo / arm height / hauteur du bras
Ø: diámetro / diameter / diamètre.

STD units	Packaging dim. (cm)	M3/ pack	NW units (kg)	Units Container 20'	Units Container 40'	Units Container HC	Units Truck 70m³	Units Truck 100m³
2	66,1x60,1x90	0,36	4,10	132	306	372	416	540
4	73,7x60,7x96,9	0,43	4,10	260	548	632	652	912
23	98x58x220	1,25	4,10	552	1.104	1.104	1.242	1.334



Silla Net-Kat (p. 56) mesa Sputnik (p. 136)
Net-Kat chair (p. 56) Sputnik table (p. 136)
Chaise Net-Kat (p. 56) table Sputnik (p. 136)



FIONA

JOSEP LLUSCÀ

Silla
Chair
Chaise

Tapizado Barcelona Dd disponible, pag. 67

Barcelona Dd Upholstered available, pag. 67

Revêtement Barcelona Dd disponible, pag. 67

 Apilable
10u. Stackable | Empilable

- Negro | Black | Noir
- Verde Oliva | Olive Green | Vert Olive
- Chocolate | Chocolate | Chocolat
- Arena | sand | sable
- Gris Oscuro | Dark Grey | Gris Foncé
- Blanco | White | Blanc

 **Certificados** | Certificates | Certificats
Fiona chair Test Certificates:
EN 15373 L1 / EN 11022 PUBLIC



Silla para uso interior y exterior. Inyectada con fibra de vidrio y PP. Apilable. Protección UV. Peso neto silla 4,14 kg. Opcional: Pinza enlace de sillas para convenciones y eventos inyectada en policarbonato translúcido.

Chair for indoor and outdoor use. Injected with fiberglass and PP. Stackable. UV protection. Chair's net weight 4,14 kg (9.12 lb). Optional: Clamp connection of chairs for conventions and events injected in translucent polycarbonate.

Chaise pour usage intérieur et extérieur. Injectée avec fibre de verre et PP. Empilable. Protection UV. Poids net chaise 4,14 kg. Optionnel: Pince de jonction des chaises pour conventions et événements injectée en polycarbonate translucide.

W 56 cm	W 22.05 in
L 55,5 cm	L 21.85 in
H 79 cm	H 31.10 in
Hs 47 cm	Hs 18.50 in
Ha 65,5 cm	Ha 25.79 in

W: ancho / width / largeur. L: largo / length / longueur
H: altura / height / hauteur. Hs: altura asiento / seat height / hauteur du siège. Ha: altura brazo / arm height / hauteur du bras
Ø: diámetro / diameter / diamètre.

STD units	Packaging dim. (cm)	M3/ pack	NW units (kg)	Units Container 20'	Units Container 40'	Units Container HC	Units Truck 70m³	Units Truck 100m³
2	66,1x60,1x90	0,36	4,14	132	306	372	416	540
4	74,2x51,7x96,9	0,37	4,14	312	624	768	748	996
24	98x58x220	1,25	4,14	576	1.152	1.152	1.296	1.392

FIONA

JOSEP LLUSCÀ

Silla con brazos
Armchair
Fauteuil

Tapizado Barcelona Dd
disponible, pag. 67

Barcelona Dd Upholstered available, pag. 67

Revêtement Barcelona Dd disponible, pag. 67

 Apilable

7u. Stackable | Empilable

- Negro | Black | Noir
- Verde Oliva | Olive Green | Vert Olive
- Chocolate | Chocolate | Chocolat
- Arena | sand | sable
- Gris Oscuro | Dark Grey | Gris Foncé
- Blanco | White | Blanc

 Certificados | Certificates | Certificats

Fiona Armchair Test Certificates:
EN 15373 L1 / EN 11022 PUBLIC



Silla con brazos para uso interior y exterior.
Inyectada con fibra de vidrio y PP. Apilable.
Protección UV. Peso neto 4,98 kg.

Armchair for indoor and outdoor use. Seat and back
injected with fiberglass and PP. Stackable.
UV protection. Net weight 4,98 kg. (10.97 lb).

Fauteuil pour usage intérieur et extérieur. Injecté
avec fibre de verre et PP. Empilable. Protection UV.
Poids net 4,98 kg.

W 58 cm	W 22.83 in
L 53 cm	L 20.87 in
H 81 cm	H 31.89 in
Hs 47,5 cm	Hs 18.70 in
Ha 67,7 cm	Ha 26.65 in

W: ancho / width / largeur. L: largo / length / longueur
H: altura / height / hauteur. Hs: altura asiento / seat height /
hauteur du siège. Ha: altura brazo / arm height / hauteur du bras
Ø: diámetro / diameter / diamètre.

STD units	Packaging dim. (cm)	M3/pack	NW units (kg)	Units Container 20'	Units Container 40'	Units Container HC	Units Truck 70m³	Units Truck 100m³
2	66,1x60,1x90	0,36	4,98	132	306	372	416	540
4	73,7x60,7x96,9	0,43	4,98	260	548	632	652	912

NEW FIONA

JOSEP LLUSCÀ

Silla con brazos
Armchair
Fauteuil

Tapizado Barcelona Dd
disponible, pag. 67

Barcelona Dd Upholstered available, pag. 67

Revêtement Barcelona Dd disponible, pag. 67

 Apilable
10u. Stackable | Empilable

- Blanco | White | Blanc
- Verde Oliva | Olive Green | Vert Olive
- Chocolate | Chocolate | Chocolat
- Arena | sand | sable
- Gris Oscuro | Dark Grey | Gris Foncé
- Negro | Black | Noir

 **Certificados** | Certificates | Certificats
New Fiona chair Test Certificates:
EN 16139 / EN 581 PUBLIC



Silla con brazos para uso interior y exterior.
Inyectada con fibra de vidrio y PP. Apilable.
Protección UV. Peso neto 4,52 kg.

Armchair for indoor and outdoor use. Seat and back
injected with fiberglass and PP. Stackable. UV
protection. Net weight 4,52 kg (9.96 lb).

Fauteuil pour usage intérieur et extérieur. Injecté
avec fibre de verre et PP. Empilable. Protection UV.
Poids net 4,52 kg.

W 52,3 cm	W 20.59 in
L 52 cm	L 20.47 in
H 80,5 cm	H 31.69 in
Hs 46,1 cm	Hs 18.15 in
Ha 67 cm	Ha 26.38 in

W: ancho / width / largeur. L: largo / length / longueur
H: altura / height / hauteur. Hs: altura asiento / seat height /
hauteur du siège. Ha: altura brazo / arm height / hauteur du bras
Ø: diámetro / diameter / diamètre.

STD units	Packaging dim. (cm)	M3/ pack	NW units (kg)	Units Container 20'	Units Container 40'	Units Container HC	Units Truck 70m³	Units Truck 100m³
4	73,7x60,7x96,9	0,43	4,52	260	548	632	652	912
20	98x58x220	1,25	4,52	480	960	960	1.080	1.160
2	66,1x60,1x90	0,36	4,52	132	306	372	416	540

Sillas con brazos New Fiona
tapizadas (p. 67) y mesa Barcino (p. 134)

New Fiona upholstered armchairs (p. 67) and
Barcino table (p. 134). Fauteuils avec revêtement
New Fiona (p. 67) et table Barcino (p. 134)



FIONA

JOSEP LLUSCÀ

Convenciones
Conventions
Conventions

Tapizado Barcelona Dd disponible, pag. 67

Barcelona Dd Upholstered available, pag. 67

Revêtement Barcelona Dd disponible, pag. 67

 Apilable
3u. Stackable | Empilable

- Verde Oliva | Olive Green | Vert Olive
- Chocolate | Chocolate | Chocolat
- Transparente/negro | Transparent/black | Transparent/noir
- Blanco | White | Blanc
- Negro | Black | Noir
- Gris Oscuro | Dark Grey | Gris Foncé
- Arena | sand | sable

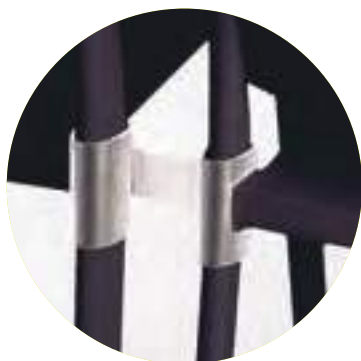

Silla para uso interior y exterior. Inyectada con fibra de vidrio y PP. Apilable. Protección UV. Opcional: Mesa auxiliar izquierda/derecha para convenciones. Conexión para la silla en acero pintado negro (RAL 9011). Opcional: Pinza enlace de sillas, para convenciones y eventos, inyectada en policarbonato translúcido. Peso neto 5,75 kg.

Chair for indoor and outdoor use. Injected with fiberglass and PP. Stackable. UV protection. Optional: Right/left hand side table for conventions. Joint for the chair in black painted steel (RAL 9011). Optional: Clamp connection of chairs, for conventions and events, injected in translucent polycarbonate. Net weight 5,75 kg. (12.65 lb).

Chaise pour usage intérieur et extérieur. Injectée avec fibre de verre et PP. Empilable. Protection UV. Optionnel: Table auxiliaire gauche/droite pour conventions. Jointure pour chaise en acier peint noir (RAL 9011). Optionnel: Pince d'assemblage de chaises, pour conventions et événements, injectée en polycarbonate translucide. Poids net 5,75 kg.

W 48 cm	W 18.89 in
L 54 cm	L 21.26 in
H 80 cm	H 31.50 in
Hs 47,5 cm	Hs 18.70 in
Ha 75 cm	Ha 29.53 in

W: ancho / width / largeur. L: largo / length / longueur
H: altura / height / hauteur. Hs: altura asiento / seat height / hauteur du siège. Ha: altura brazo / arm height / hauteur du bras
Ø: diámetro / diameter / diamètre.

STD units	Packaging dim. (cm)	M3/ pack	NW units (kg)	Units Container 20'	Units Container 40'	Units Container HC	Units Truck 70m³	Units Truck 100m³
4	73,7x60,7x96,9	0,43	5,75	260	548	632	652	912
24	98x58x220	1,25	5,75	576	1.152	1.152	1.296	1.392



FIONA

JOSEP LLUSCÀ

Silla
Chair
Chaise

Tapizado Barcelona Dd disponible, pag. 67

Barcelona Dd Upholstered available, pag. 67

Revêtement Barcelona Dd disponible, pag. 67

 Apilable
10u. Stackable | Empilable

 Transparente/Negro |
Transparent/Black |
Transparent/Noir



Silla para uso interior y exterior. Inyectada con fibra de vidrio y PP. Apilable. Protección UV. Peso neto silla 4,14 kg. Opcional: Pinza enlace de sillas para convenciones y eventos inyectada en policarbonato translúcido.

Chair for indoor and outdoor use. Injected with fiberglass and PP. Stackable. UV protection. Chair's net weight 4,14 kg (9.12 lb). Optional: Clamp connection of chairs for conventions and events injected in translucent polycarbonate.

Chaise pour usage intérieur et extérieur. Injectée avec fibre de verre et PP. Empilable. Protection UV. Poids net chaise 4,14 kg. Optionnel: Pince de jonction des chaises pour conventions et événements injectée en polycarbonate translucide.

W 48 cm	W 18.90 in
L 54 cm	L 21.26 in
H 80 cm	H 31.50 in
Hs 47,5 cm	Hs 18.70 in

W: ancho / width / largeur. **L:** largo / length / longueur
H: altura / height / hauteur. **Hs:** altura asiento / seat height / hauteur du siège. **Ha:** altura brazo / arm height / hauteur du bras
Ø: diámetro / diameter / diamètre.

STD units	Packaging dim. (cm)	M3/ pack	NW units (kg)	Units Container 20'	Units Container 40'	Units Container HC	Units Truck 70m³	Units Truck 100m³
2	66,1x60,1x90	0,36	4,14	132	306	372	416	540
4	74,2x51,7x96,9	0,37	4,14	312	624	768	748	996
24	98x58x220	1,239	4,14	576	1.152	1.152	1.296	1.392

FIONA NEW FIONA TAPIZADA

JOSEP LLUSCÀ

✦ Tapizado | Upholstered | Revêtement



Colores tapizado
Upholstered colours
Couleurs revêtement

 Chocolate |
Chocolate | Chocolat

 Arena | Sand | Sable

 Rojo | Red | Rouge

 Blanco | White | Blanc

 Negro | Black | Noir

 Nilo | Nilo | Nilo

Colores silla
Chair colours
Couleurs chaise

 Blanco | White | Blanc

 Gris oscuro |
Dark Grey | Gris foncé

 Chocolate |
Chocolate | Chocolat

 Negro | Black | Noir

 Arena | Sand | Sable

 Verde oliva |
Olive green | Vert olive

Tejido en vinílico espumado con soporte textil en poliéster algodón. Apto para mobiliario de interior con buena resistencia al desgaste por el roce, impermeable, durable y de fácil limpieza. Se recomienda lavar a mano con detergente neutro. Colores firmes y duraderos. Espumas de espesor 5 mm y presión de 18 kg.

Vinyl fabric with foam and textile backing of polyester/ cotton. Suitable for indoor with good resistance to friction, waterproof, durable and easy to clean. Recommended to be hand washed with mild detergent. Firm and lasting colours. Foam of 5 mm thick with pressure of 18 kg.

Tissu en vinyle et mousse avec support textile en polyester coton. Approprié pour les meubles d'intérieur avec une bonne résistance à l'abrasion, étanche à l'eau, durable et facile à nettoyer. Il est recommandé de laver à la main avec un détergent neutre. Couleurs solides et durables. Mousse de 5 mm d'épaisseur et pression de 18 kg.

LISBOA

JOAN GASPAR

Silla
Chair
Chaise

Tapizado Barcelona Dd disponible, pag. 71

Barcelona Dd Upholstered available, pag. 71

Revêtement Barcelona Dd disponible, pag. 71

 Apilable
10u. Stackable | Empilable

- Blanco | White | Blanc
- Rojo | Red | Rouge
- Verde Oliva | Olive Green | Vert Olive
- Chocolate | Chocolate | Chocolat
- Negro | Black | Noir
- Arena | sand | sable
- Gris Oscuro | Dark Grey | Gris Foncé
- Azul Retro | Retro Bleu | Bleu Rétro
- Burdeos | Burgundy | Bordeaux

 Certificados | Certificates | Certificats

Lisboa chair Test Certificates:
EN 15373 L2



Silla para uso interior y exterior. Inyectada en fibra de vidrio con PP mediante tecnología de moldeo asistida por gas. Apilable. Protección UV. Peso neto 3,36 kg.

Chair for indoor and outdoor use. Injected with fiberglass and PP using gas assisted injection moulding technology. Stackable. UV protection. Net weight 3,36 kg. (7.39 lb).

Chaise d'intérieur et extérieur. Injectée avec fibre de verre et PP, en utilisant technologie de moulage assistée par gaz. Empilable. Protection UV. Poids net 3,36 kg.

W 47 cm	W 18.50 in
L 51 cm	L 20.08 in
H 82 cm	H 32.28 in
Hs 46 cm	Hs 18.11 in

W: ancho / width / largeur. L: largo / length / longueur
H: altura / height / hauteur. Hs: altura asiento / seat height / hauteur du siège. Ha: altura brazo / arm height / hauteur du bras
Ø: diámetro / diameter / diamètre.

STD units	Packaging dim. (cm)	M3/ pack	NW units (kg)	Units Container 20'	Units Container 40'	Units Container HC	Units Truck 70m³	Units Truck 100m³
2	66,1x60,1x90	0,36	3,36	132	306	372	416	540
4	62,4x61x104	0,40	3,36	216	456	456	552	808
24	96x58x220	1,25	3,36	576	1.152	1.152	1.296	1.392

LISBOA

JOAN GASPAR

Silla con brazos
Armchair
Fauteuil

Tapizado Barcelona Dd
disponible, pag. 71

Barcelona Dd Upholstered available, pag. 71

Revêtement Barcelona Dd disponible, pag. 71

 Apilable
7u. Stackable | Empilable

- Blanco | White | Blanc
- Rojo | Red | Rouge
- Verde Oliva | Olive Green | Vert Olive
- Chocolate | Chocolate | Chocolat
- Negro | Black | Noir
- Arena | sand | sable
- Gris Oscuro | Dark Grey | Gris Foncé
- Azul Retro | Retro Bleu | Bleu Rétro
- Burdeos | Burgundy | Bordeaux

 Certificados | Certificates | Certificats

Lisboa Armchair Test Certificates:
EN 15373 L2



Silla con brazos para uso interior y exterior. Inyectada en fibra de vidrio con PP mediante tecnología de moldeo asistida por gas. Brazos sujetos a la estructura mediante tornillos inoxidables. Apilable. Protección UV. Peso neto 3,67 kg.

Armchair for indoor and outdoor use. Injected with fiberglass and PP using gas assisted injection moulding technology. Armrests fixed to the structure with steel screws. Stackable. UV protection. Net weight 3,67 kg. (8.07 lb).

Fauteuil d'intérieur et extérieur. Injecté avec fibre de verre et PP, en utilisant technologie de moulage assistée par gaz. Accoudoirs fixé à la structure avec des vis en acier inoxydable. Empilable. Protection UV. Poids net 3,67 kg.

W 58 cm	W 22.83 in
L 51 cm	L 20.08 in
H 82 cm	H 32.28 in
Hs 46	Hs 18.11 in
Ha 70 cm	Ha 27.56 in

W: ancho / width / largeur. L: largo / length / longueur
H: altura / height / hauteur. Hs: altura asiento / seat height / hauteur du siège. Ha: altura brazo / arm height / hauteur du bras
Ø: diámetro / diameter / diamètre.

STD units	Packaging dim. (cm)	M3/ pack	NW units (kg)	Units Container 20'	Units Container 40'	Units Container HC	Units Truck 70m³	Units Truck 100m³
2	66,1x60,1x90	0,36	3,67	132	306	372	416	540
4	62,4x61x104	0,40	3,67	216	456	456	552	808
23	98x58x220	1,25	3,67	552	1.104	1.104	1.242	1.334









LISBOA TAPIZADA

JOAN GASPAR







✦ Tapizado | Upholstered | Revêtement



Colores tapizado
Upholstered colours
Couleurs revêtement

 Chocolate Chocolate Chocolat	 Blanco White Blanc
 Arena Sand Sable	 Negro Black Noir
 Rojo Red Rouge	 Nilo Nilo Nilo

Colores silla
Chair colours
Couleurs chaise

 Blanco White Blanc	 Verde oliva Olive green Vert olive
 Rojo Red Rouge	 Arena Sand Sable
 Chocolate Chocolate Chocolat	 Gris oscuro Dark Grey Gris foncé
 Negro Black Noir	 Azul retro Retro Bleu Bleu Rétro
 Burdeos Burgundy Bordeaux	

Tejido en vinílico espumado con soporte textil en poliéster algodón. Apto para mobiliario de interior con buena resistencia al desgaste por el roce, impermeable, durable y de fácil limpieza.

Se recomienda lavar a mano con detergente neutro. Colores firmes y duraderos. Espumas de espesor 5 mm y presión de 18 kg.

Vinyl fabric with foam and textile backing of polyester/ cotton. Suitable for indoor with good resistance to friction, waterproof, durable and easy to clean.

Recommended to be hand washed with mild detergent. Firm and lasting colours. Foam of 5 mm thick with pressure of 18 kg.

Tissu en vinyle et mousse avec support textile en polyester coton. Approprié pour les meubles d'intérieur avec une bonne résistance à l'abrasion, étanche à l'eau, durable et facile à nettoyer.

Il est recommandé de laver à la main avec un détergent neutre. Couleurs solides et durables. Mousse de 5 mm d'épaisseur et pression de 18 kg.

PEACH

JOAN GASPAR

Silla con brazos
Armchair
Fauteuil

 Apilable
8u. Stackable | Empilable

- Blanco | White | Blanc
- Rojo | Red | Rouge
- Negro | Black | Noir
- Chocolate | Chocolate | Chocolat
- Verde Oliva | Olive Green | Vert Olive
- Arena | sand | sable

 Certificados | Certificates | Certificats

Peach Armchair Test Certificates:
EN 581 / EN 15373 L2



Silla con brazos para uso interior y exterior.
Inyectada en fibra de vidrio con PP mediante
tecnología de moldeo asistida por gas. Apilable.
Protección UV. Peso neto 4,20 kg.

Armchair for indoor and outdoor use. Injected with
fiberglass and PP using gas assisted injection
moulding technology. Stackable. UV protection.
Net weight 4,20 kg (9.26 lb).

Fauteuil d'intérieur et extérieur. Injecté avec fibre
de verre et PP, en utilisant technologie de moulage
assistée par gaz. Empilable. Protection UV. Poids net
4,20 kg.

W 55,9 cm	W 22.01 in
L 48 cm	L 18.90 in
H 74,5 cm	H 29.33 in
Hs 44,4 cm	Hs 17.48 in
Ha 63,9 cm	Ha 25.16 in

W: ancho / width / largeur. L: largo / length / longueur
H: altura / height / hauteur. Hs: altura asiento / seat height /
hauteur du siège. Ha: altura brazo / arm height / hauteur du bras
Ø: diámetro / diameter / diamètre.

STD units	Packaging dim. (cm)	M3/ pack	NW units (kg)	Units Container 20'	Units Container 40'	Units Container HC	Units Truck 70m³	Units Truck 100m³
2	66,1x60,1x90	0,36	4,20	132	306	372	416	540
4	73,7x60,7x96,9	0,43	4,20	260	548	632	652	912
24	98x58x220	1,25	4,20	576	1.152	1.152	1.296	1.392

PEACH TAPIZADA

JOAN GASPAR

✦ Tapizado | Upholstered | Revêtement



Colores tapizado
Upholstered colours
Couleurs revêtement

 Chocolate |
Chocolate | Chocolat

 Blanco | White | Blanc

 Arena | Sand | Sable

 Negro | Black | Noir

 Rojo | Red | Rouge

 Nilo | Nilo | Nilo

Colores silla
Chair colours
Couleurs chaise

 Blanco | White | Blanc

 Negro | Black | Noir

 Rojo | Red | Rouge

 Verde oliva |
Olive green | Vert olive

 Chocolate |
Chocolate | Chocolat

Tejido en vinílico espumado con soporte textil en poliéster algodón. Apto para mobiliario de interior con buena resistencia al desgaste por el roce, impermeable, durable y de fácil limpieza.

Se recomienda lavar a mano con detergente neutro. Colores firmes y duraderos. Espumas de espesor 5 mm y presión de 18 kg.

Vinyl fabric with foam and textile backing of polyester/ cotton. Suitable for indoor with good resistance to friction, waterproof, durable and easy to clean.

Recommended to be hand washed with mild detergent. Firm and lasting colours. Foam of 5 mm thick with pressure of 18 kg.

Tissu en vinyle et mousse avec support textile en polyester coton. Approprié pour les meubles d'intérieur avec une bonne résistance à l'abrasion, étanche à l'eau, durable et facile à nettoyer.

Il est recommandé de laver à la main avec un détergent neutre. Couleurs solides et durables. Mousse de 5 mm d'épaisseur et pression de 18 kg.



Silla Peach pág. 37

Peach chair pag. 37

Chaise Peach pag. 37



NEUTRA

JOAN GASPAR

Silla
Chair
Chaise

 Apilable
10u. Stackable | Empilable

- Blanco | White | Blanc
- Chocolate | Chocolate | Chocolat
- Verde Oliva | Olive Green | Vert Olive
- Arena | sand | sable
- Rojo | Red | Rouge

 Certificados | Certificats | Certificats

Neutra chair Test Certificates:
EN 15373 L2 / EN 581 PUBLIC



Silla para uso interior y exterior. Inyectada en fibra de vidrio con PP mediante tecnología de moldeo asistida por gas. Apilable. Protección UV. Peso neto 3,20 kg.

Chair for indoor and outdoor use. Injected with fiberglass and PP using gas assisted injection moulding technology. Stackable. UV protection. Net weight 3,20 kg (7.05 lb).

Chaise d'intérieur et extérieur. Injectée avec fibre de verre et PP, en utilisant technologie de moulage assistée par gaz. Empilable. Protection UV. Poids net 3,20 kg.

W 47 cm	W 18.50 in
L 48 cm	L 18.90 in
H 78 cm	H 30.71 in
Hs 46 cm	Hs 18.11 in

W: ancho / width / largeur. L: largo / length / longueur
H: altura / height / hauteur. Hs: altura asiento / seat height / hauteur du siège. Ha: altura brazo / arm height / hauteur du bras
Ø: diámetro / diameter / diamètre.

STD units	Packaging dim. (cm)	M3/ pack	NW units (kg)	Units Container 20'	Units Container 40'	Units Container HC	Units Truck 70m³	Units Truck 100m³
2	66,1x60,1x90	0,36	3,2	132	306	372	416	540
4	74,2x51,7x96,9	0,37	3,2	312	624	768	748	996
29	98x58x220	1,25	3,2	696	1.392	1.392	1.566	1.682

NEUTRA TAPIZADA

JOAN GASPAR

✦ Tapizado | Upholstered | Revêtement



Colores tapizado
Upholstered colours
Couleurs revêtement

 Chocolate |
Chocolate | Chocolat

 Blanco | White | Blanc

 Arena | Sand | Sable

 Negro | Black | Noir

 Rojo | Red | Rouge

 Nilo | Nilo | Nilo

Colores silla
Chair colours
Couleurs chaise

 Blanco | White | Blanc

 Negro | Black | Noir

 Rojo | Red | Rouge

 Verde oliva |
Olive green | Vert olive

 Chocolate |
Chocolate | Chocolat

Tejido en vinílico espumado con soporte textil en poliéster algodón.
Apto para mobiliario de interior con buena resistencia al desgaste
por el roce, impermeable, durable y de fácil limpieza.

Se recomienda lavar a mano con detergente neutro. Colores firmes y
duraderos. Espumas de espesor 5 mm y presión de 18 kg.

Vinyl fabric with foam and textile backing of polyester/ cotton.
Suitable for indoor with good resistance to friction, waterproof,
durable and easy to clean.

Recommended to be hand washed with mild detergent. Firm and
lasting colours. Foam of 5 mm thick with pressure of 18 kg.

Tissu en vinyle et mousse avec support textile en polyester coton.
Approprié pour les meubles d'intérieur avec une bonne résistance à
l'abrasion, étanche à l'eau, durable et facile à nettoyer.

Il est recommandé de laver à la main avec un détergent neutre.
Couleurs solides et durables. Mousse de 5 mm d'épaisseur et
pression de 18 kg.

Posibilidad de tapizar asiento y respaldo,
o solamente el asiento.

Possibility of upholstering the seat and
the backrest, or only the seat.

Possibilité de tapisser l'assise et le
dossier, ou seulement l'assise.

Silla Neutra (p. 76) y mesa Barcino pie central (p. 134)

Neutra chair (p. 76) and pedestal Barcino table (p. 134)

Chaise Neutra (p. 76) et table Barcino pied central (p. 134)





CARLA

FABRIZIO BATONI

Silla
Chair
Chaise

 Apilable
5u. Stackable | Empilable

- Blanco | White | Blanc
- Rojo | Red | Rouge
- Negro | Black | Noir
- Verde Oliva | Olive Green | Vert Olive
- Arena | sand | sable



 Certificados | Certificats | Certificats
Carla chair Test Certificates:
EN 15373 L2



Silla para uso interior y exterior. Inyectada con fibra de vidrio y PP. Apilable. Protección contra rayos UV. Peso neto silla 4 kg.

Chair for indoor and outdoor use, injected with fiberglass and PP. Stackable. UV protection. Chair's net weight 4 kg. (8.82 lb).

Chaise d'intérieur et extérieur. Injectée avec fibre de verre et PP. Empilable. Protection contre les rayons UV. Poids net chaise 4 kg.

W 55,9 cm	W 22.01 in
L 48 cm	L 18.90 in
H 74,5 cm	H 29.33 in
Hs 44,4 cm	Hs 17.48 in
Ha 63,9 cm	Ha 25.16 in

W: ancho / width / largeur. L: largo / length / longueur
H: altura / height / hauteur. Hs: altura asiento / seat height / hauteur du siège. Ha: altura brazo / arm height / hauteur du bras
Ø: diámetro / diameter / diamètre.

STD units	Packaging dim. (cm)	M3/ pack	NW units (kg)	Units Container 20'	Units Container 40'	Units Container HC	Units Truck 70m ³	Units Truck 100m ³
2	66,1x60,1x90	0,36	4	132	306	372	416	540
4	60x57x105	0,43	4	320	656	648	800	896
14	98x58x220	1,25	4	336	672	672	756	812

Silla Carla (p. 80) y mesa Miró con tablero Durolight (p. 252)

Carla chair (p. 80) with Miró table with Durolight top (p. 252)

Chaise Carla (p. 80) et table Miró avec Durolight plateaux (p. 252)



LAMA

JOSEP LLUSCÀ

Silla
Chair
Chaise

 Apilable
10u. Stackable | Empilable

- Chocolate | Chocolate | Chocolat
- Blanco | White | Blanc
- Negro | Black | Noir
- Verde Oliva | Olive Green | Vert Olive
- Arena | sand | sable
- Gris Oscuro | Dark Grey | Gris Foncé



 Certificados | Certificates | Certificats

Lama chair Test Certificates:
EN 15373 L2 / EN 581 PUBLIC



Silla para uso interior y exterior. Inyectada en fibra de vidrio con PP mediante tecnología de moldeo asistida por gas. Apilable. Protección UV. Peso neto 4 kg. Opcional: Pinza enlace de sillas para convenciones y eventos inyectada en policarbonato translúcido.

Chair for indoor and outdoor use. Injected with fiberglass and PP using gas assisted injection moulding technology. Stackable. UV protection. Net weight 4 kg. (8.80 lb). Optional: Clamp connection of chairs for conventions and events injected in translucent polycarbonate.

Chaise d'intérieur et extérieur. Injectée avec fibre de verre et PP, en utilisant technologie de moulage assistée par gaz. Empilable. Protection UV. Poids net 4 kg. Optionnel: Pince de jonction des chaises pour conventions et événements injectée en polycarbonate translucide.

W 48 cm	W 18.90 in
L 54 cm	L 21.26 in
H 80 cm	H 31.50 in
Hs 47,5 cm	Hs 18.70 in

W: ancho / width / largeur. L: largo / length / longueur
H: altura / height / hauteur. Hs: altura asiento / seat height / hauteur du siège. Ha: altura brazo / arm height / hauteur du bras
Ø: diámetro / diameter / diamètre.

STD units	Packaging dim. (cm)	M3/ pack	NW units (kg)	Units Container 20'	Units Container 40'	Units Container HC	Units Truck 70m ³	Units Truck 100m ³
2	66,1x60,1x90	0,36	4	132	306	372	416	540
4	74,2x51,7x96,9	0,37	4	312	624	768	748	996
24	98x58x220	1,25	4	576	1.152	1.152	1.296	1.392

LAMA

JOSEP LLUSCÀ

Silla con brazos
Armchair
Fauteuil

 Apilable
7u. Stackable | Empilable

- Negro | Black | Noir
- Verde Oliva | Olive Green | Vert Olive
- Chocolate | Chocolate | Chocolat
- Arena | sand | sable
- Gris Oscuro | Dark Grey | Gris Foncé
- Blanco | White | Blanc



 Certificados | Certificates | Certificats

Lama Armchair Test Certificates:
EN 15373L1 / EN 581 PUBLIC



Silla con brazos para uso interior y exterior.
Inyectada en fibra de vidrio con PP mediante
tecnología de moldeo asistida por gas. Apilable.
Protección UV. Peso neto 4,3 kg.

Armchair for indoor and outdoor use. Injected with
fiberglass and PP using gas assisted injection
moulding technology. Stackable. UV protection. Net
weight 4,3 kg. (9.48 lb).

Fauteuil d'intérieur et extérieur. Injecté avec fibre de
verre et PP, en utilisant technologie de moulage assistée
par gaz. Empilable. Protection UV. Poids net 4,3 kg.

W 58 cm	W 22.83 in
L 53 cm	L 20.87 in
H 81 cm	H 31.89 in
Hs 47,5 cm	Hs 18.70 in
Ha 67,7 cm	Ha 26.65 in

W: ancho / width / largeur. L: largo / length / longueur
H: altura / height / hauteur. Hs: altura asiento / seat height /
hauteur du siège. Ha: altura brazo / arm height / hauteur du bras
Ø: diámetro / diameter / diamètre.

STD units	Packaging dim. (cm)	M3/pack	NW units (kg)	Units Container 20'	Units Container 40'	Units Container HC	Units Truck 70m ³	Units Truck 100m ³
2	66,1x60,1x90	0,36	4,3	132	306	372	416	540
4	73,7x60,7x96,9	0,43	4,3	260	548	632	652	912
20	98x58x220	1,25	4,3	384	768	768	864	928





TRAMA

JOSEP LLUSCÀ

Silla
Chair
Chaise

 Apilable
7u. Stackable | Empilable

- Blanco | White | Blanc
- Negro | Black | Noir
- Verde Oliva | Olive Green | Vert Olive
- Chocolate | Chocolate | Chocolat
- Arena | sand | sable

 Certificados | Certificates | Certificats

Trama chair Test Certificates:
EN 581 / EN 15373 L2



Silla para uso interior y exterior. Inyectada en fibra de vidrio con PP mediante tecnología de moldeo asistida por gas. Apilable. Protección UV. Peso neto 4 kg. Opcional: Pinza enlace de sillas para convenciones y eventos inyectada en policarbonato translúcido.

Chair for indoor and outdoor use. Injected with fiberglass and PP using gas assisted injection moulding technology. Stackable. UV protection. Net weight 4 kg. (8.80 lb). Optional: Clamp connection of chairs for conventions and events injected in translucent polycarbonate.

Chaise d'intérieur et extérieur. Injectée avec fibre de verre et PP, en utilisant technologie de moulage assistée par gaz. Empilable. Protection contre les rayons UV. Poids net 4 kg. Optionnel: Pince de jonction des chaises pour conventions et événements injectée en polycarbonate translucide.

W 48 cm | W 18.90 in
L 54 cm | L 21.26 in
H 80 cm | H 31.50 in
Hs 47,5 cm | Hs 18.70 in

W: ancho / width / largeur. L: largo / length / longueur
H: altura / height / hauteur. Hs: altura asiento / seat height / hauteur du siège. Ha: altura brazo / arm height / hauteur du bras
Ø: diámetro / diameter / diamètre.

STD units	Packaging dim. (cm)	M3/ pack	NW units (kg)	Units Container 20'	Units Container 40'	Units Container HC	Units Truck 70m ³	Units Truck 100m ³
2	66,1x60,1x90	0,36	4	132	306	372	416	540
4	74,2x51,7x96,9	0,37	4	312	624	768	748	996
24	98x58x220	1,25	4	576	1.152	1.152	1.296	1.392

TRAMA

JOSEP LLUSCÀ

Silla con brazos
Armchair
Fauteuil

 Apilable
7u. Stackable | Empilable

- Blanco | White | Blanc
- Negro | Black | Noir
- Verde Oliva | Olive Green | Vert Olive
- Chocolate | Chocolate | Chocolat
- Arena | sand | sable

 Certificados | Certificates | Certificats

Trama Armchair Test Certificates:
EN 581 / EN 15373 L2



Silla con brazos para uso interior y exterior.
Inyectada en fibra de vidrio con PP mediante
tecnología de moldeo asistida por gas. Apilable.
Protección UV. Peso neto 4,3 kg.

Armchair for indoor and outdoor use. Injected with
fiberglass and PP using gas assisted injection
moulding technology. Stackable. UV protection. Net
weight 4,3 kg. (9.48 lb).

Fauteuil d'intérieur et extérieur. Injecté avec fibre
de verre et PP, en utilisant technologie de moulage
assistée par gaz. Empilable. Protection UV. Poids net
4,3 kg.

W 57 cm	W 22.44 in
L 54 cm	L 22.26 in
H 80 cm	H 31.50 in
Hs 47,5 cm	Hs 18.70 in
Ha 66 cm	Ha 25.98 in

W: ancho / width / largeur. L: largo / length / longueur
H: altura / height / hauteur. Hs: altura asiento / seat height /
hauteur du siège. Ha: altura brazo / arm height / hauteur du bras
Ø: diámetro / diameter / diamètre.

STD units	Packaging dim. (cm)	M3/ pack	NW units (kg)	Units Container 20'	Units Container 40'	Units Container HC	Units Truck 70m ³	Units Truck 100m ³
2	66,1x60,1x90	0,36	4,3	132	306	372	416	540
4	73,7x60,7x96,9	4,43	4,3	260	548	632	652	912
20	98x58x220	1,25	4,3	384	768	768	864	928





Sillas Trama (p. 86), mesas Sputnik (p. 136)

Trama chairs (p. 86), Sputnik tables (p. 136)

Chaises Trama (p. 86), tables Sputnik (p. 136) 89

GINA

JOAN GASPAR

Silla
Chair
Chaise

 Apilable
10u. Stackable | Empilable

- Blanco | White | Blanc
- Arena | sand | sable
- Chocolate | Chocolate | Chocolat
- Verde Oliva | Olive Green | Vert Olive
- Rojo | Red | Rouge



 Certificados | Certificats | Certificats

Gina chair Test Certificates:
EN 581 / EN 15373 L2



Silla para uso interior y exterior. Inyectada en fibra de vidrio con PP mediante tecnología de moldeo asistida por gas. Apilable. Protección UV. Peso neto 3,35 kg.

Chair for indoor and outdoor use. Injected with fiberglass and PP using gas assisted injection moulding technology. Stackable. UV protection. Net weight 3,35 kg. (7.38 lb).

Chaise d'intérieur et extérieur. Injectée avec fibre de verre et PP, en utilisant technologie de moulage assistée par gaz. Empilable. Protection UV. Poids net 3,35 kg.

W 52,3 cm	W 20.59 in
L 52cm	L 20.47 in
H 80,5 cm	H 31.69 in
Hs 46,1 cm	Hs 18.15 in

W: ancho / width / largeur. L: largo / length / longueur
H: altura / height / hauteur. Hs: altura asiento / seat height / hauteur du siège. Ha: altura brazo / arm height / hauteur du bras
Ø: diámetro / diameter / diamètre.

STD units	Packaging dim. (cm)	M3/ pack	NW units (kg)	Units Container 20'	Units Container 40'	Units Container HC	Units Truck 70m³	Units Truck 100m³
2	66,1x60,1x90	0,36	3,35	132	306	372	416	540
4	66,1x60,1x90	0,36	3,35	264	612	744	832	1.080
32	98x58x220	1,25	3,35	768	1.536	1.536	1.728	1.856

GINA

JOAN GASPAR

Silla con brazos
Armchair
Fauteuil

 Apilable
7u. Stackable | Empilable

- Blanco | White | Blanc
- Arena | sand | sable
- Chocolate | Chocolate | Chocolat
- Verde Oliva | Olive Green | Vert Olive
- Rojo | Red | Rouge



 Certificados | Certificates | Certificats

Gina Armchair Test Certificates:
EN 581 / EN 15373 L2



Silla con brazos para uso interior y exterior. Inyectada en fibra de vidrio con PP mediante tecnología de moldeo asistida por gas. Apilable. Protección UV. Peso neto 3,65 kg. Tornillos inoxidables.

Armchair for indoor and outdoor use. Injected with fiberglass and PP using gas assisted injection moulding technology. Stackable. UV protection. Net weight 3,65 kg. (8.04 lb). Stainless steel screws.

Fauteuil d'intérieur et extérieur. Injecté avec fibre de verre et PP, en utilisant technologie de moulage assistée par gaz. Empilable. Protection UV. Poids net 3,65 kg. Vis en acier inoxydable.

W 56,9 cm	W 22.40 in
L 52 cm	L 20.47 in
H 80,5 cm	H 31.69 in
Hs 46,1 cm	Hs 18.15 in
Ha 66,5 cm	Ha 26.18 in

W: ancho / width / largeur. L: largo / length / longueur
H: altura / height / hauteur. Hs: altura asiento / seat height / hauteur du siège. Ha: altura brazo / arm height / hauteur du bras
Ø: diámetro / diameter / diamètre.

STD units	Packaging dim. (cm)	M3/pack	NW units (kg)	Units Container 20'	Units Container 40'	Units Container HC	Units Truck 70m³	Units Truck 100m³
2	66,1x60,1x90	0,36	3,65	132	306	372	416	540
4	66,1x60,1x90	0,43	3,65	264	612	744	832	1080
4x6	120x80x220	2,11	3,65	264	600	600	792	864

Silla Gina (p. 90)
Gina chair (p. 90)
Chaise Gina (p. 90)





SPOT

JOSEP LLUSCÀ

Silla
Chair
Chaise

 Apilable
10u. Stackable | Empilable

- Blanco | White | Blanc
- Rojo | Red | Rouge
- Verde Oliva | Olive Green | Vert Olive
- Chocolate | Chocolate | Chocolat
- Arena | sand | sable
- Azul Retro | Retro Bleu | Bleu Rétro
- Gris Verdoso | Green-grey | Gris Vert



 Certificados | Certificates | Certificats

Spot chair Test Certificates:
EN 581 PUBLIC



Silla para uso interior y exterior. Inyectada en fibra de vidrio con PP mediante tecnología de moldeo asistida por gas. Apilable. Protección contra rayos UV. Peso neto 2,80 kg.

Chair for indoor and outdoor use. Injected in fiber glass with PP using gas assisted injection moulding technology. Stackable. UV Protection. Net weight 2,80kg (6.16 lb).

Chaise d'intérieur et extérieur. Injectée avec fibre de verre et PP, en utilisant technologie de moulage assistée par gaz. Empilable. Protection UV. Poids net 2,80 kg.

W 45 cm	W 17.72 in
L 54 cm	L 21.26 in
H 78 cm	H 30.71 in
Hs 45 cm	Hs 17.72 in

W: ancho / width / largeur. L: largo / length / longueur
H: altura / height / hauteur. Hs: altura asiento / seat height / hauteur du siège. Ha: altura brazo / arm height / hauteur du bras
Ø: diámetro / diameter / diamètre.

STD units	Packaging dim. (cm)	M3/ pack	NW units (kg)	Units Container 20'	Units Container 40'	Units Container HC	Units Truck 70m³	Units Truck 100m³
2	66,1x60,1x90	0,36	2,8	138	304	304	436	562
4	73,7x52x97,5	0,37	2,8	280	568	568	632	808
22	90x58x218	1,14	2,8	528	1.056	1.056	1.188	1.276

Sillas Spot (p. 94) mesa Vela S (p. 142)

Spot chairs (p. 94) Vela S table (p. 142)

Chaises Spot (p. 94) table Vela S (p. 142)



FRESH

JOSEP LLUSCÀ

Silla
Chair
Chaise

 Apilable
7u. Stackable | Empilable

- Blanco | White | Blanc
- Negro | Black | Noir
- Arena | sand | sable
- Chocolate | Chocolate | Chocolat
- Gris Oscuro | Dark Grey | Gris Foncé
- Rojo | Red | Rouge



 Certificados | Certificates | Certificats

Fresh chair Test Certificates:
EN 581-1 EN 581-2 PUBLIC
EN 16139 L1



Silla para uso interior y exterior. Inyectada en PP.
Apilable. Protección UV. Peso neto silla 2.77 kg.

Chair for indoor and outdoor use. Injected with PP.
Stackable. UV protection. Chair's net weight 6.10 lb.

Chaise pour usage intérieur et extérieur. Injectée avec
PP. Empilable. Protection UV. Poids net chaise 2.77 kg.

W 50,4 cm | W 19.84 in
L 54,6 cm | L 21.50 in
H 78,4 cm | H 30.87 in

W: ancho / width / largeur. **L:** largo / length / longueur
H: altura / height / hauteur. **Hs:** altura asiento / seat height /
hauteur du siège. **Ha:** altura brazo / arm height / hauteur du bras
Ø: diámetro / diameter / diamètre.

STD units	Packaging dim. (cm)	M3/ pack	NW units (kg)	Units Container 20'	Units Container 40'	Units Container HC	Units Truck 70m³	Units Truck 100m³
4	74,2x51,7x96	0,37	2,9	312	624	768	748	996
6	80x61x110	0,53	2,9	312	690	786	888	1.044
22	98x58x220	1,25	2,9	528	1.056	1.056	1.188	1.276

FRESH

JOSEP LLUSCÀ

Silla con brazos
Armchair
Fauteuil

 Apilable
7u. Stackable | Empilable

- Blanco | White | Blanc
- Negro | Black | Noir
- Arena | sand | sable
- Chocolate | Chocolate | Chocolat
- Gris Oscuro | Dark Grey | Gris Foncé
- Rojo | Red | Rouge



 Certificados | Certificates | Certificats

Fresh chair Test Certificates:
EN 581-1 EN 581-2 PUBLIC
EN 16139 L1



Silla con brazos para uso interior y exterior. Inyectada en fibra de vidrio con PP mediante tecnología de moldeo asistida por gas. Brazos sujetos a la estructura mediante tornillos inoxidables. Apilable. Protección UV. Peso neto 3,67 kg.

Armchair for indoor and outdoor use. Injected with fiberglass and PP using gas assisted injection moulding technology. Armrests fixed to the structure with steel screws. Stackable. UV protection. Net weight 3,67 kg. (8.07 lb).

Fauteuil d'intérieur et extérieur. Injecté avec fibre de verre et PP, en utilisant technologie de moulage assistée par gaz. Accoudoirs fixé à la structure avec des vis en acier inoxydable. Empilable. Protection UV. Poids net 3,67 kg.

W 58,8 cm | W 23.15 in
L 54,6 cm | L 21.50 in
H 78,4 cm | H 30.87 in

W: ancho / width / largeur. L: largo / length / longueur
H: altura / height / hauteur. Hs: altura asiento / seat height /
hauteur du siège. Ha: altura brazo / arm height / hauteur du bras
Ø: diámetro / diameter / diamètre.

STD units	Packaging dim. (cm)	M3/pack	NW units (kg)	Units Container 20'	Units Container 40'	Units Container HC	Units Truck 70m³	Units Truck 100m³
4	73,7x60,7x96,9	0,43	3,3	260	548	632	652	912
6	80x61x110	0,53	3,3	312	690	786	888	1.044
17	98x58x220	1,25	3,3	408	816	816	918	986

Silla y silla con brazos Fresh (p. 96-97) y mesa New Dessa (p. 156)

Fresh chair and armchair (p. 96-97) and New Dessa table (p. 156)

Chaise et fauteuil Fresh (p. 96-97) et table New Dessa (p. 156)





WIND

JOSEP LLUSCÀ

Silla
Chair
Chaise

Apilable
10u. Stackable | Empilable

- Blanco | White | Blanc
- Arena | Sand | Sable
- Gris Oscuro | Dark Grey | Gris Foncé
- Chocolate | Chocolate | Chocolat
- Rojo | Red | Rouge



Certificados | Certificates | Certificats

Wind chair Test Certificates:
EN 581-1 EN 581-2 PUBLIC
EN 16139 L1



Silla para uso interior y exterior. Inyectada en PP. Apilable. Protección UV. Peso neto silla 2,9 kg.

Chair for indoor and outdoor use. Injected with PP. Stackable. UV protection. Chair's net weight 2,9 kg (6.39 lb)

Chaise pour usage intérieur et extérieur. Injectée avec PP. Empilable. Protection UV. Poids net chaise 2,9 kg.

W50,40 cm | W 19.84 in
L 54,60 cm | L 21.50 in
H 78,40 cm | H 30.87 in
Hs 45 cm | Hs 17.71 in

W: ancho / width / largeur. **L:** largo / length / longueur
H: altura / height / hauteur. **Hs:** altura asiento / seat height / hauteur du siège. **Ha:** altura brazo / arm height / hauteur du bras
Ø: diámetro / diameter / diamètre.

STD units	Packaging dim. (cm)	M3/ pack	NW units (kg)	Units Container 20'	Units Container 40'	Units Container HC	Units Truck 70m³	Units Truck 100m³
4	74,2x51,7x96,9	0,37	2,7	312	624	768	748	996
6	80x61x110	0,57	2,7	312	690	786	888	1.044
22	98x58x220	1,25	2,7	528	1.056	1.056	1.188	1.276

WIND

JOSEP LLUSCÀ

Silla con brazos
Armchair
Fauteuil

 Apilable
7u. Stackable | Empilable

- Blanco | White | Blanc
- Arena | Sand | Sable
- Gris Oscuro | Dark Grey | Gris Foncé
- Chocolate | Chocolate | Chocolat
- Rojo | Red | Rouge



 Certificados | Certificates | Certificats

Wind chair Test Certificates:
EN 581-1 EN 581-2 PUBLIC
EN 16139 L1



Silla con brazos para uso interior y exterior.
Inyectada en PP. Apilable. Protección UV. Peso neto
silla 3,3 kg.

Armchair for indoor and outdoor use. Injected with
PP. Stackable. UV protection. Chair's net weight
3,3 kg (7.27 lb).

Fauteuil pour usage intérieur et extérieur. Injectée
avec PP. Empilable. Protection UV. Poids net
chaise 3,3 kg.

W 58,80 cm	W 23.15 in
L 54,60 cm	L 21.50 in
H 78,40 cm	H 30.87 in
Hs 45 cm	Hs 17.71 in
Ha 66 cm	Ha 25.98 in

W: ancho / width / largeur. **L:** largo / length / longueur
H: altura / height / hauteur. **Hs:** altura asiento / seat height /
hauteur du siège. **Ha:** altura brazo / arm height / hauteur du bras
Ø: diámetro / diameter / diamètre.

STD units	Packaging dim. (cm)	M3/ pack	NW units (kg)	Units Container 20'	Units Container 40'	Units Container HC	Units Truck 70m ³	Units Truck 100m ³
4	73,7x60,7x96,9	0,43	3,15	260	548	632	652	912
6	80x61x110	0,53	3,15	312	690	786	888	1.044
17	58x98x220	1,25	3,15	408	816	816	918	986



Sillas y sillas con brazos Wind (p.100-101) y mesa London (p. 277)

Chairs and armchairs Wind (p. 100-101) London table (p. 277)

Chaises et fauteuils Wind (p. 100-101) table London (p. 277)



ELBA

DAVID CARRASCO BARCELÓ

Silla
Chair
Chaise

Apilable
Stackable | Empilable

- Gris Oscuro | Dark Grey | Gris Foncé
- Gris Verdoso | Green-grey | Gris Vert
- Arena | Sand | Sable
- Azul Retro | Retro Bleu | Bleu Rétro
- Blanco | White | Blanc



Certificados | Certificates | Certificats

Elba Chair Test Certificates:
EN 581-1 EN 581-2
PUBLIC
EN 16139 L1



Silla para uso interior y exterior. Inyectada en PP. Apilable. Protección UV. Peso neto silla 3,15 kg.

Chair for indoor and outdoor use. Injected with PP. Stackable. UV protection. Chair's net weight 3,15 kg (6.94 lb)

Chaise pour usage intérieur et extérieur. Injectée avec PP. Empilable. Protection UV. Poids net chaise 3,15 kg.

W 50 cm	W 19.68 in
L 53,50 cm	L 21.06 in
H 80 cm	H 31.49 in
Hs 45,90 cm	Hs 18.07 in

W: ancho / width / largeur. L: largo / length / longueur
H: altura / height / hauteur. Hs: altura asiento / seat height / hauteur du siège. Ha: altura brazo / arm height / hauteur du bras
Ø: diámetro / diameter / diamètre.

STD units	Packaging dim. (cm)	M3/ pack	NW units (kg)	Units Container 20'	Units Container 40'	Units Container HC	Units Truck 70m³	Units Truck 100m³
4	74,2x51,7x96,9	0,37	3,15	312	624	768	748	996
6	80x61x110	0,53	3,15	312	690	786	888	1.044
20	98x58x220	1,25	3,15	480	960	960	1.080	1.160

ELBA

DAVID CARRASCO BARCELÓ

Silla con brazos

Armchair

Fauteuil

 Apilable

8u. Stackable | Empilable

Blanco | White | Blanc

Arena | Sand | Sable

Gris Oscuro | Dark Grey | Gris Foncé

Azul Retro | Retro Bleu | Bleu Rétro

Gris Verdoso | Green-grey | Gris Vert



 Certificados | Certificates | Certificats

Elba Armchair Test Certificates:

EN 581-1 EN 581-2

PUBLIC

EN 16139 L1



Silla con brazos para uso interior y exterior. Inyectada en PP. Apilable. Protección UV. Peso neto silla 3,6 kg.

Armchair for indoor and outdoor use. Injected with PP. Stackable. UV protection. Chair's net weight 3,6 kg (7.93 lb).

Fauteuil pour usage intérieur et extérieur. Injectée avec PP. Empilable. Protection UV. Poids net chaise 3,6 kg.

W 56,10 cm | W 22.08 in

L 53,50 cm | L 21.06 in

H 80 cm | H 31.49 in

Hs 45,90 cm | Hs 18.07 in

Ha 64,90 cm | Ha 25.55 in

W: ancho / width / largeur. **L:** largo / length / longueur

H: altura / height / hauteur. **Hs:** altura asiento / seat height / hauteur du siège. **Ha:** altura brazo / arm height / hauteur du bras

Ø: diámetro / diameter / diamètre.

STD units	Packaging dim. (cm)	M3/ pack	NW units (kg)	Units Container 20'	Units Container 40'	Units Container HC	Units Truck 70m³	Units Truck 100m³
4	73,7x60,7x96,9	0,43	3,6	260	548	632	652	912
6	80x61x110	0,53	3,6	312	690	786	888	1.044
20	98x58x220	1,25	3,6	480	960	960	1.080	1.160

DANNA

DAVID CARRASCO BARCELÓ

Silla
Chair
Chaise

Apilable
10u. Stackable | Empilable

- Blanco | White | Blanc
- Arena | Sand | Sable
- Gris Oscuro | Dark Grey | Gris Foncé
- Azul Retro | Retro Bleu | Bleu Rétro
- Gris Verdoso | Green-grey | Gris Vert



Certificados | Certificates | Certificats

Danna Chair Test Certificates:
EN 581-1 EN 581-2
PUBLIC
EN 16139 L1



Silla para uso interior y exterior. Inyectada en PP. Apilable. Protección UV. Peso neto silla 3,15 kg.

Chair for indoor and outdoor use. Injected with PP. Stackable. UV protection. Chair's net weight 3,15 kg (6.94 lb)

Chaise pour usage intérieur et extérieur. Injectée avec PP. Empilable. Protection UV. Poids net chaise 3,15 kg.

W50 cm	W 19.68 in
L 53,50 cm	L 21.06 in
H 80 cm	H 31.49 in
Hs 45,90 cm	Hs 18.07 in

W: ancho / width / largeur. L: largo / length / longueur
H: altura / height / hauteur. Hs: altura asiento / seat height / hauteur du siège. Ha: altura brazo / arm height / hauteur du bras
Ø: diámetro / diameter / diamètre.

STD units	Packaging dim. (cm)	M3/ pack	NW units (kg)	Units Container 20'	Units Container 40'	Units Container HC	Units Truck 70m³	Units Truck 100m³
4	74,2x51,7x96,9	0,37	3,15	312	624	768	748	996
6	80x61x110	0,53	3,15	312	690	786	888	1.044
20	98x58x220	1,25	3,15	480	960	960	1.080	1.160

DANNA

DAVID CARRASCO BARCELÓ

Silla con brazos
Armchair
Fauteuil

 Apilable
8u. Stackable | Empilable

- Blanco | White | Blanc
- Arena | Sand | Sable
- Gris Oscuro | Dark Grey | Gris Foncé
- Azul Retro | Retro Bleu | Bleu Rétro
- Gris Verdoso | Green-grey | Gris Vert

 Certificados | Certificates | Certificats

Danna Armchair Test Certificates:
EN 581-1 EN 581-2
PUBLIC
EN 16139 L1



Silla con brazos para uso interior y exterior. Inyectada en PP. Apilable. Protección UV. Peso neto silla 3,6 kg.

Armchair for indoor and outdoor use. Injected with PP. Stackable. UV protection. Chair's net weight 3,6 kg (7.93 lb).

Fauteuil pour usage intérieur et extérieur. Injectée avec PP. Empilable. Protection UV. Poids net chaise 3,6 kg.

W 56,10 cm	W 22.08 in
L 53,50 cm	L 21.06 in
H 80 cm	H 31.49 in
Hs 45,90 cm	Hs 18.07 in
Ha 64,90 cm	Ha 25.55 in

W: ancho / width / largeur. L: largo / length / longueur
H: altura / height / hauteur. Hs: altura asiento / seat height /
hauteur du siège. Ha: altura brazo / arm height / hauteur du bras
Ø: diámetro / diameter / diamètre.

STD units	Packaging dim. (cm)	M3/pack	NW units (kg)	Units Container 20'	Units Container 40'	Units Container HC	Units Truck 70m³	Units Truck 100m³
4	73,7x60,7x96,9	0,43	3,6	260	548	632	652	912
6	80x61x110	0,53	3,6	312	690	786	888	1.044
20	98x58x220	1,25	3,6	480	960	960	1.080	1.160



Sillas y sillas con brazos Danna (p. 106-107) mesa Drop con HPL madera lavada (p. 133)

Danna chairs and armchairs (p. 106-107) with Drop table with washed wood HPL (p. 133)

Chaises et fauteuils Danna (p. 106-107) table Drop avec HPL bois délavé (p. 133)



ONA

DAVID CARRASCO BARCELÓ

Silla
Chair
Chaise

Apilable
8u. Stackable | Empilable

Estructura + Asiento |
Structure + Seat | Structure + Assise

- Blanco | White | Blanc
- Arena | sand | sable
- Chocolate | Chocolate | Chocolat
- Arena/Chocolate | Sand/Chocolate | Sable/Chocolat
- Blanco/Rojo | White/Red | Blanc/Rouge
- Blanco/Arena | White/Sand | Blanc/Sable
- Blanco/Gris Oscuro | White/DarGrey | Blanc/Gris Foncé
- Blanco/Chocolate | White/Chocolate | Blanc/Chocolat

Certificados | Certificates | Certificats

Ona chair Test Certificates:
EN 16139 L1 / EN 581 PUBLIC



Silla para uso interior y exterior. Estructura y asiento inyectados en polipropileno. Asiento sujeto a la estructura mediante tornillos zincados. Apilable. Protección contra rayos UV. Peso neto 3,57 kg.

Chair for indoor and outdoor use. Structure and seat injected with polypropylene. Seat fixed to the structure with galvanized screws. Stackable. UV protection. Net weight 3,57 kg (7.87 lb).

Chaise d'intérieur et extérieur. Structure et siège injectés en polypropylène. Siège fixé à la structure avec des vis galvanisés. Empilable. Protection contre les rayons UV. Poids net 3,57 kg.

W 50,3 cm	W 19.80 in
L 52,1 cm	L 20.51 in
H 79,5 cm	H 31.30 in
Hs 46,4 cm	Hs 18.27 in

W: ancho / width / largeur. L: largo / length / longueur
H: altura / height / hauteur. Hs: altura asiento / seat height / hauteur du siège. Ha: altura brazo / arm height / hauteur du bras
Ø: diámetro / diameter / diamètre.

STD units	Packaging dim. (cm)	M3/pack	NW units (kg)	Units Container 20'	Units Container 40'	Units Container HC	Units Truck 70m³	Units Truck 100m³
4	74,2x51,7x96,9	0,37	2,9	312	624	768	748	996
6	80x61x110	0,53	2,9	312	690	786	888	1.044
24	98x58x220	1,25	2,9	576	1.152	1.152	1.296	1.392

ONA

DAVID CARRASCO BARCELÓ

Silla con brazos
Armchair
Fauteuil



Apilable

7u. Stackable | Empilable

Estructura + Asiento |

Structure + Seat | Structure + Assise

Blanco | White | Blanc

Arena | sand | sable

Chocolate | Chocolate | Chocolat

Arena/Chocolate | Sand/Chocolate | Sable/Chocolat

Blanco/Rojo | White/Red | Blanc/Rouge

Blanco/Arena | White/Sand | Blanc/Sable

Blanco/Gris Oscuro | White/DarGrey | Blanc/Gris Foncé

Blanco/Chocolate | White/Chocolate | Blanc/Chocolat



Certificados | Certificates | Certificats

Ona chair Test Certificates:
EN 16139 L1 / EN 581 PUBLIC



Silla con brazos para uso interior y exterior. Estructura y asiento inyectados en polipropileno. Asiento sujeto a la estructura mediante tornillos zincados. Apilable. Protección contra rayos UV. Peso neto 3,85 kg.

Armchair for indoor and outdoor use. Structure and seat injected with polypropylene. Seat fixed to the structure with galvanized screws. Stackable. UV protection. Net weight 3,85 kg (8.49 lb).

Fauteuil d'intérieur et extérieur. Structure et siège injectés en polypropylène. Siège fixé à la structure avec des vis galvanisés. Empilable. Protection contre les rayons UV. Poids net 3,85 kg.

W 56,8 cm	W 22.36 in
L 52,1 cm	L 20.51 in
H 79,5 cm	H 31.30 in
Hs 46,4 cm	Hs 18.27 in
Ha 65,7 cm	Ha 25.87 in

W: ancho / width / largeur. L: largo / length / longueur

H: altura / height / hauteur. Hs: altura asiento / seat height / hauteur du siège. Ha: altura brazo / arm height / hauteur du bras

Ø: diámetro / diameter / diamètre.

STD units	Packaging dim. (cm)	M3/ pack	NW units (kg)	Units Container 20'	Units Container 40'	Units Container HC	Units Truck 70m³	Units Truck 100m³
4	73,7x60,7x96,9	0,43	3,30	260	548	632	652	912
6	80x61x110	0,53	3,30	312	690	786	888	1.044
18	98x58x220	1,25	3,30	432	864	864	972	1.044





Sillas con brazos Ona (p. 110), mesa Sputnik (p.136)

Ona armchairs (p.110), Sputnik table (p.136)

Fauteuils Ona (p. 110), table Sputnik (p. 136)

JULIA

JOAN GASPAR

Silla
Chair
Chaise

Apilable
20u. Stackable | Empilable

- Blanco | White | Blanc
- Negro | Black | Noir
- Rojo | Red | Rouge
- Chocolate | Chocolate | Chocolat
- Verde Lima | Lime Green | CitronVert
- Naranja | Orange | Orange



Certificados | Certificates | Certificats

Julia chair Test Certificates:
EN 581 PUBLIC



Silla para uso interior y exterior. Inyectada en polipropileno. Apilable. Protección UV. Peso neto 3,35 kg.

Chair for indoor and outdoor use. Injected with polypropylene. Stackable. UV protection. Net weight 3,35 kg (7.39 lb).

Chaise d'intérieur et extérieur. Injectée en polypropylène. Empilable. Protection UV. Poids net 3,35 kg.

W 54 cm	W 21.26 in
L 56 cm	L 22.05 in
H 82 cm	H 32.28 in
Hs 44 cm	Hs 17.32 in

W: ancho / width / largeur. L: largo / length / longueur
H: altura / height / hauteur. Hs: altura asiento / seat height /
hauteur du siège. Ha: altura brazo / arm height / hauteur du bras
Ø: diámetro / diameter / diamètre.

STD units	Packaging dim. (cm)	M3/ pack	NW units (kg)	Units Container 20'	Units Container 40'	Units Container HC	Units Truck 70m ²	Units Truck 100m ²
4	60x56x107,5	0,36	3,35	280	640	640	704	832
23	60x60x240	0,86	3,35	621	1.380	1.380	2.024	2.392



POLE DELUXE

JOSEP LLUSCÀ

Silla con brazos
Armchair
Fauteuil

Apilable
7u. Stackable | Empilable

Blanco | White | Blanc
 Negro | Black | Noir



Certificados | Certificates | Certificats

Pole deLuxe chair Test Certificates:
BS EN 581 PUBLIC / EN 15373 LA



Silla con brazos para uso interior y exterior. Asiento inyectado en polipropileno. Patas de aluminio anodizado de alta resistencia pintadas por pulverización al horno. Apilable. Sistema de evacuación de agua. Protección contra rayos UV. Peso neto 3,85 kg.

Armchair for indoor and outdoor use. Seat injected with polypropylene. High-resistance anodized aluminium powder-coated legs. Stackable. Water drainage system. UV protection. Net weight 3,85 kg. (8,47 lb).

Fauteuil d'intérieur et extérieur. Siège et dossier injectés en polypropylène. Pieds en aluminium anodisé de haute résistance peints par pulvérisation au four. Empilable. Système d'évacuation d'eau. Protection contre les rayons UV. Poids net 3,85 kg.

W 60 cm	W 23.62 in
L 60 cm	L 23.62 in
H 78,5 cm	H 30.91 in
Hs 46 cm	Hs 18.11 in
Ha 67 cm	Ha 26.38 in

W: ancho / width / largeur. L: largo / length / longueur
H: altura / height / hauteur. Hs: altura asiento / seat height / hauteur du siège. Ha: altura brazo / arm height / hauteur du bras
Ø: diámetro / diameter / diamètre.

STD units	Packaging dim. (cm)	M3/ pack	NW units (kg)	Units Container 20'	Units Container 40'	Units Container HC	Units Truck 70m³	Units Truck 100m³
2	66,1x60,1x90	0,36	3,85	132	306	372	416	540
4	83,5x60x95	0,48	3,85	208	432	432	552	608
16	98x58x220	1,25	3,85	384	768	768	864	928

POLE

JOSEP LLUSCÀ

Silla con brazos
Armchair
Fauteuil



Apilable

7u. Stackable | Empilable

- Chocolate | Chocolate | Chocolat
- Verde Oliva | Olive Green | Vert Olive
- Arena | sand | sable
- Blanco | White | Blanc
- Negro | Black | Noir
- Rojo | Red | Rouge
- Naranja | Orange | Orange
- Verde Lima | Lime Green | CitronVert



Certificados | Certificates | Certificats

Pole chair Test Certificates:
BS EN 581 PUBLIC / EN 15373 LA



Sillón para uso interior y exterior. Asiento inyectado en polipropileno. Patas de aluminio anodizado de alta resistencia. Apilable. Sistema de evacuación de agua. Protección contra rayos UV. Peso neto 3,85 kg.

Armchair for indoor and outdoor use. Seat injected with polypropylene. High-resistance anodized aluminium legs. Stackable. Water drainage system. UV protection. Net weight 3,85 kg. (8.48 lb).

Fauteuil d'intérieur et extérieur. Siège et dossier injectés en polypropylène. Pieds en aluminium anodisé de haute résistance. Empilable. Système d'évacuation d'eau. Protection contre les rayons UV. Poids net 3,85 kg.

W 60 cm	W 23.62 in
L 60 cm	L 23.62 in
H 78,5 cm	H 30.91 in
Hs 46 cm	Hs 18.11 in
Ha 67 cm	Ha 26.38 in

W: ancho / width / largeur. L: largo / length / longueur
H: altura / height / hauteur. Hs: altura asiento / seat height / hauteur du siège. Ha: altura brazo / arm height / hauteur du bras
Ø: diámetro / diameter / diamètre.

STD units	Packaging dim. (cm)	M3/ pack	NW units (kg)	Units Container 20'	Units Container 40'	Units Container HC	Units Truck 70m ³	Units Truck 100m ³
2	66,1x60,1x90	0,36	3,85	132	306	372	416	540
4	83,5x60x95	0,48	3,85	208	432	432	552	628
16	98x58x220	1,25	3,85	384	768	768	864	928



Sillas Pole (p. 177) con mesa Montblanc (p. 274)
Pole chairs (p. 177) with Montblanc table (p. 274)
Chaises Pole (p. 177) avec Montblanc table (p. 274)



MOON

JOSEP LLUSCÀ

Silla
Chair
Chaise

Apilable
10u. Stackable | Empilable

- Blanco | White | Blanc
- Negro | Black | Noir
- Arena | sand | sable
- Chocolate | Chocolate | Chocolat
- Verde Oliva | Olive Green | Vert Olive
- Rojo | Red | Rouge
- Naranja | Orange | Orange
- Verde Lima | Lime Green | CitronVert



Certificados | Certificats | Certificats

Moon chair Test Certificates:
EN 16139 L1 / EN 581 PUBLIC



Silla para uso interior y exterior. Asiento inyectado en polipropileno. Patas de aluminio anodizado de alta resistencia. Apilable. Sistema de evacuación de agua. Protección contra rayos UV. Peso neto 3,40 kg.

Chair for indoor and outdoor use. Seat injected with polypropylene. High-resistance anodized aluminium legs. Stackable. Water drainage system. UV protection. Net weight 3,40 kg. (7.48 lb).

Chaise d'intérieur et extérieur. Siège et dossier injectés en polypropylène. Pieds en aluminium anodisé de haute résistance. Empilable. Système d'évacuation d'eau. Protection contre les rayons UV. Poids net 3,40 kg.

W 50 cm	W 19.69 in
L 58,5 cm	L 23.03 in
H 80,5 cm	H 31.69 in
Hs 44 cm	Hs 17.32 in

W: ancho / width / largeur. L: largo / length / longueur
H: altura / height / hauteur. Hs: altura asiento / seat height / hauteur du siège. Ha: altura brazo / arm height / hauteur du bras
Ø: diámetro / diameter / diamètre.

STD units	Packaging dim. (cm)	M3/ pack	NW units (kg)	Units Container 20'	Units Container 40'	Units Container HC	Units Truck 70m³	Units Truck 100m³
2	66,1x60,1x90	0,36	3,40	132	306	372	416	540
4	74,2x51,7x96,9	0,37	3,40	312	624	768	748	996
20	98x58x220	1,25	3,40	480	960	960	1.080	1.160

SUN

JOSEP LLUSCÀ

Silla con brazos
Armchair
Fauteuil



Apilable

10u. Stackable | Empilable

- Blanco | White | Blanc
- Negro | Black | Noir
- Arena | sand | sable
- Chocolate | Chocolate | Chocolat
- Verde Oliva | Olive Green | Vert Olive
- Rojo | Red | Rouge
- Naranja | Orange | Orange
- Verde Lima | Lime Green | CitronVert



Certificados | Certificates | Certificats

Sun chair Test Certificates:
EN 16139 L1 / EN 581 PUBLIC



Sillón para uso interior y exterior. Asiento inyectado en polipropileno. Patas de aluminio anodizado de alta resistencia. Apilable. Sistema de evacuación de agua. Protección contra rayos UV. Peso neto 3,70 kg.

Armchair for indoor and outdoor use. Seat injected with polypropylene. High-resistance anodized aluminium legs. Stackable. Water drainage system. UV protection. Net weight 3,70 kg. (8.16 lb).

Fauteuil d'intérieur et extérieur. Siège et dossier injectés en polypropylène. Pieds en aluminium anodisé de haute résistance. Empilable. Système d'évacuation d'eau. Protection contre les rayons UV. Poids net 3,70 kg.

W 60 cm	W 23.62 in
L 58 cm	L 22.83 in
H 76 cm	H 29.92 in
Hs 46 cm	Hs 18.11 in
Ha 63 cm	Ha 24.80 in

W: ancho / width / largeur. L: largo / length / longueur
H: altura / height / hauteur. Hs: altura asiento / seat height / hauteur du siège. Ha: altura brazo / arm height / hauteur du bras
Ø: diámetro / diameter / diamètre.

STD units	Packaging dim. (cm)	M3/ pack	NW units (kg)	Units Container 20'	Units Container 40'	Units Container HC	Units Truck 70m ³	Units Truck 100m ³
2	66,1x60,1x90	0,36	3,70	132	306	372	416	540
4	73,7x60x96,9	0,43	3,70	260	548	632	652	912
20	98x58x220	1,25	3,70	480	960	960	1.080	1.160





Sillas Sun (p. 121) con mesa Point (p. 152)

Sun chairs (p. 121) with Point table (p. 152)

Chaises Sun (p. 121) avec table Point (p. 152)

SEAT PAD

Téxtil
Textile
Textile

✦ Tapizado | Upholstered | Revêtement

■ Antracita | Antracite | Antracite



Para evitar marcas, por favor no apile las sillas tapizadas.

In order to avoid marks, please do not stack upholstered chairs.

Pour éviter des marques, ne pas empiler les chaises tapissées.

Cojín de asiento de fieltro de lana de alta calidad con revestimiento de silicona que impide que la almohadilla se deslice en superficies lisas. Seat Pad es un cojín cómodo y práctico que se convierte en un complemento ideal para la mayoría de sillas Barcelona Dd.

Seat cushion made of high quality wool felt with an overleaf silicone coating that prevents the pad from slipping on smooth surfaces. Seat Pad is a comfortable and practical cushion, an ideal complement for the majority of Barcelona Dd chairs.

Coussin de siège en feutre en laine de haute qualité avec revêtement en silicone au dos qui l'empêche de glisser sur les surfaces lisses. Seat Pad est un confortable et pratique coussin, qui devient un complément idéal pour la majorité des chaises Barcelona Dd.

MANTENIMIENTO TAPIZADO |

UPHOLSTERY MAINTENANCE | ENTRETIEN DE REVÊTEMENTS

Todas las telas Sunbrella® se diseñan para combinar el más alto nivel de diseño y desempeño. Para un fácil mantenimiento del día a día de su tela Sunbrella:

1. Cepille para quitar toda la suciedad.
2. Prepare una solución limpiadora de agua y jabón suave.
3. Utilice un cepillo de cerdas suaves para limpiar.
4. Permita que la solución limpiadora empape la tela.
5. Enjuague muy bien hasta eliminar todos los residuos de jabón.
6. Deje secar al aire.

All Sunbrella® fabrics are engineered to combine the highest level of design and performance. For easy day-to-day maintenance of your Sunbrella fabric:

1. Brush off loose dirt.
2. Spray on a cleaning solution of water and mild soap.
3. Use a soft bristle brush to clean.
4. Allow cleaning solution to soak into the fabric.
5. Rinse thoroughly until all soap residue is removed.
6. Air dry.

Tous les tissus Sunbrella® sont conçus pour combiner le plus haut niveau de design et de performance. Pour un entretien quotidien facile de votre tissu Sunbrella:

1. Enlevez la saleté avec une brosse.
2. Préparez une solution de nettoyage en mélangeant de l'eau et un savon doux ou du liquide vaisselle.
3. Nettoyez avec une brosse à poils souples.
4. Attendez que la solution de nettoyage pénètre dans le tissu.
5. Rincez abondamment jusqu'à élimination complète de tous les résidus de savon.
6. Séchez à l'air.

TEJIDO VINÍLICO |

VINYL FABRIC |

TISSU EN VINYLE

Tejido en vinílico espumado con soporte textil en poliéster algodón. Apto para mobiliario de interior con buena resistencia al desgaste por el roce, impermeable, durable y de fácil limpieza. Se recomienda lavar a mano con detergente neutro. Colores firmes y duraderos. Espumas de espesor 5 mm y presión de 18 kg.

Vinyl fabric with foam and textile backing of polyester/ cotton. Suitable for indoor with good resistance to friction, waterproof, durable and easy to clean. Recommended to be hand washed with mild detergent. Firm and lasting colours. Foam of 5 mm thick with pressure of 18 kg.

Tissu en vinyle et mousse avec support textile en polyester coton. Approprié pour les meubles d'intérieur avec une bonne résistance à l'abrasion, étanche à l'eau, durable et facile à nettoyer. Il est recommandé de laver à la main avec un détergent neutre. Couleurs solides et durables. Mousse de 5 mm d'épaisseur et pression de 18 kg.

MESAS

TABLES | TABLES

MESAS PIE CENTRAL

PEDESTAL BASE TABLES |

TABLES PIED CENTRAL

Toledo aire cuadrada	128
Toledo aire redonda	129
Fall	132
Drop	133
Barcino pie central	134
Barcino pie central red.	135
Sputnik pie central simple	136
Sputnik pie central doble	137
Net	140
Vela S	142
Vela M	144
Vela L	145

MESAS 4 PATAS

4 LEG TABLES | TABLES 4 PIEDS

Barcino	146
Barcino compact	147
Corner	148
Point	152
Noa	154
New Dessa	156
New Flash	157

MESAS PIE CENTRAL ALTO

HIGH PEDESTAL BASE TABLE |

TABLE PIED CENTRAL HAUTE

Barcino pie central alto	158
Sputnik pie central alto	159

TOLEDO AIRE

JORGE PENSI

Mesa
Table
Table

- Marfil | Ivory | Ivoire
- Gris Verdoso | Green-grey | Gris Vert
- Chocolate | Chocolate | Chocolat

Pie disponible en:
Pedestal available in:
Pied disponible en:

- Blanco | White | Blanc
- Negro | Black | Noir



Mesa para uso interior y exterior. Estructura de aluminio pintado y sobre en compacto fenólico del mismo color. Disponible en dos medidas 70 x 70 cm y 80 x 80 cm.

Table for indoor and outdoor use. Painted aluminium structure with an HPL table top of the same colour. Available in two different sizes 70 x 70 cm (27.55 x 27.55 in) and 80 x 80 cm (31.49 x 31.49 in).

Table pour usage intérieur et extérieur. Structure en aluminium peint et plateau en compact phénolique du même coloris. Disponible en dimensions 70x70 et 80x80cm.

SIZE 70x70	SIZE 27.55x27.55 in
W 70 cm	W 27.55 in
L 70 cm	L 27.55 in
H 74 cm	H 29.13 in

SIZE 80x80	SIZE 31.49x31.49 in
W 80 cm	W 31.49 in
L 80 cm	L 31.49 in
H 74 cm	H 29.13 in

W: ancho / width / largeur. **L:** largo / length / longueur
H: altura / height / hauteur. **Hs:** altura asiento / seat height / hauteur du siège. **Ha:** altura brazo / arm height / hauteur du bras
Ø: diámetro / diameter / diamètre.

STD units	Packaging dim. (cm)	M3/ pack	NW units (kg)	Units Container 20'	Units Container 40'	Units Container HC	Units Truck 70m³	Units Truck 100m³
1	71x74x20	0,105	9,75	154	350	350	462	504
1	81x84x20	0,136	11,47	165	375	375	495	540

TOLEDO AIRE

JORGE PENSI

Mesa
Table
Table

- Marfil | Ivory | Ivoire
- Gris Verdoso | Green-grey | Gris Vert
- Chocolate | Chocolate | Chocolat

Pie disponible en:
Pedestal available in:
Pied disponible en:

- Blanco | White | Blanc
- Negro | Black | Noir



Mesa para uso interior y exterior. Estructura de aluminio pintado y sobre en compacto fenólico del mismo color. Disponible en dos medidas Ø70 cm y Ø80 cm..

Table for indoor and outdoor use. Painted aluminium structure with an HPL table top of the same colour. Available in two different sizes Ø70 cm (Ø27.55 in) and Ø80 cm (Ø31.49 in).

Table pour usage intérieur et extérieur. Structure en aluminium peint et plateau en compact phénolique du même coloris. Disponible en dimensions Ø70cm et Ø80cm.

SIZE ø70 cm | SIZE ø27.55 in
H 74,0 cm | H 29.13 in

SIZE ø80 cm | SIZE ø31.49 in
H 74,0 cm | H 29.13 in

W: ancho / width / largeur. L: largo / length / longueur
H: altura / height / hauteur. Hs: altura asiento / seat height / hauteur du siège. Ha: altura brazo / arm height / hauteur du bras
Ø: diámetro / diameter / diamètre.

STD units	Packaging dim. (cm)	M3/ pack	NW units (kg)	Units Container 20'	Units Container 40'	Units Container HC	Units Truck 70m³	Units Truck 100m³
1	71x74x20	0,105	8,25	154	350	350	462	504
1	81x84x20	0,136	9,67	165	375	375	495	540



Silla Toledo Aire (p. 26), mesa Toledo Aire (p. 129)
Toledo Aire chair (p. 26), Toledo Aire table (p. 129)
Chaise Toledo Aire (p. 26), table Toledo Aire (p. 129)



FALL

Pie
Pedestal
Pied

 Apilable
Stackable | Empilable

- Blanco | White | Blanc
- Negro | Black | Noir
- Arena | Sand | Sable



Pie de mesa en aluminio pintado. Sistema abatible. Uso interior y exterior. (Consultar tabla de combinaciones de pies y sobres en pag. 162)

Table base in painted aluminium. Folding system. Indoor and outdoor use. (See table combination for pedestalar bases and table tops on pag. 162)

Pied de table en aluminium peint. Système de repliment. Utilisation intérieur et extérieur. (Voir le tableau de combinaison pour piedset plateaux pag. 162)



W 50 cm | W 35.43 in
L 50 cm | L 35.43 in
H 79 cm | H 28.34 in

W: ancho / width / largeur. L: largo / length / longueur
H: altura / height / hauteur. Hs: altura asiento / seat height /
hauteur du siège. Ha: altura brazo / arm height / hauteur du bras
Ø: diámetro / diameter / diamètre.

STD units	Packaging dim. (cm)	M3/ pack	NW units (kg)	Units Container 20'	Units Container 40'	Units Container HC	Units Truck 70m³	Units Truck 100m³
1	59x55x13,5	0,043	8,25	630	1.300	1.500	1.700	1.900
	+64,5x7x7	+0,003						

DROP

BARCELONA Dd

Pie
Pedestal
Pied

 Apilable
Stackable | Empilable

- Blanco | White | Blanc
- Arena | sand | sable
- Negro | Black | Noir

Disponible hasta final de existencias.
Available until end of stock
Disponible jusqu'à la fin du stock



Pie de mesa en aluminio pintado. Sistema abatible. Uso interior y exterior. (Consultar tabla de combinaciones de pies y sobres en pag. 162).

Table base in painted aluminium. Folding system. Indoor and outdoor use. (See table combination for pedestral bases and table tops on pag. 162).

Pied de table en aluminium peint. Système de repilement. Utilisation intérieur et extérieur. (Voir le tableau de combinaison pour piedset plateaux pag. 162).

W 50 cm | W 35.43 in
L 50 cm | L 35.43 in
H 72 cm | H 29.13 in

W: ancho / width / largeur. L: largo / length / longueur
H: altura / height / hauteur. Hs: altura asiento / seat height / hauteur du siège. Ha: altura brazo / arm height / hauteur du bras
Ø: diámetro / diameter / diamètre.

STD units	Packaging dim. (cm)	M3/pack	NW units (kg)	Units Container 20'	Units Container 40'	Units Container HC	Units Truck 70m³	Units Truck 100m³
1	59x55x13,5	1,28	8,25	630	1.300	1.500	1.700	1.900
	+64,5x7x7	+0,17						

BARCINO

JOAN GASPAR

Mesa pie central
Pedestal base table
Table pied central

Personalización de colores disponible bajo pedido y sujetos a cantidades mínimas. Consulte el Departamento Comercial.

Colour customization is available upon request. Minimum orders are applicable. Contact the Sales Department.

Personnalisation de couleurs disponible sur commande. Quantités minimales à appliquer. Consultez le Département Commercial.



- Arena | sand | sable
- Negro | Black | Noir
- Blanco | White | Blanc

Certificados | Certificates | Certificats

Barcino table Test Certificates:
EN 581 PUBLIC



Mesa para uso interior y exterior. Estructura de aluminio anodizado pintado por pulverización y secado al horno 40 x 20 mm y 1,5 mm de grosor. Sobre de 4 mm de grosor. Barcino 80 x 80, base de 40 x 40 cm y tubo de 8 x 8 cm. Peso neto mesa 80 x 80, 26 kg. Barcino 90 x 90, base de 45 x 45 cm y tubo de 8 x 8 cm. Peso neto mesa 90 x 90, 33 kg.

Table for indoor and outdoor use. Powder coated anodized aluminium frame and oven-drying 40 x 20 mm and 1,5 mm thick. Table top of 4 mm thickness. Barcino 80 x 80, base of 40x 40 cm and tube of 8 x 8 cm. 80 x 80 table net weight 26 kg (57,32 lb). Barcino 90 x 90, base of 45 x 45 cm and tube of 8 x 8 cm. 90 x 90 table net weight 33 kg (72,75 lb).

Table pour usage intérieur et extérieur. Structure en aluminium anodisé peinte par pulvérisation et séchée au four 40 x 20 mm et 1,5 mm de grosseur. Plateau de 4 mm de grosseur. Barcino 80 x 80, base de 40 x 40 cm et tube de 8 x 8 cm. Poids net table 80 x 80, 26 kg. Barcino 90 x 90, base de 45 x 45 cm et tube de 8 x 8 cm. Poids net table 90 x 90, 33 kg.

W 80 cm	W 31.5 in
L 80 cm	L 31.5 in
H 74 cm	H 29.13 in

W 90 cm	W 35.43 in
L 90 cm	L 35.43 in
H 74 cm	H 29.13 in

W: ancho / width / largeur. L: largo / length / longueur

H: altura / height / hauteur. Hs: altura asiento / seat height / hauteur du siège. Ha: altura brazo / arm height / hauteur du bras

Ø: diámetro / diameter / diamètre.

STD units	Packaging dim. (cm)	M3/ pack	NW units (kg)	Units Container 20'	Units Container 40'	Units Container HC	Units Truck 70m³	Units Truck 100m³
1	82x82x15	0,10	26	200	440	440	-	-
1	92x92x15	0,13	33	200	440	440	-	-

BARCINO

JOAN GASPAR

Mesa pie central
Pedestal base table
Table pied central

Personalización de colores disponible bajo pedido y sujetos a cantidades mínimas. Consulte el Departamento Comercial.

Colour customization is available upon request. Minimum orders are applicable. Contact the Sales Department.

Personnalisation de couleurs disponible sur commande. Quantités minimales à appliquer. Consultez le Département Commerciale.



- Arena | sand | sable
- Negro | Black | Noir
- Blanco | White | Blanc

 Certificados | Certificates | Certificats

Barcino table Test Certificates:
EN 581 PUBLIC



Mesa para uso interior y exterior. Estructura de aluminio anodizado pintado por pulverización y secado al horno. Sobre de 4 mm de grosor. Barcino Ø 60 cm con base de Ø 35 cm y tubo de Ø 6 cm. Peso neto mesa Ø 60, 13 kg. Barcino Ø 80 cm con base de Ø 45 cm y tubo de Ø 8 cm. Peso neto mesa Ø 80, 22 kg.

Table for indoor and outdoor use. Powder coated anodized aluminium frame and oven-drying. Table top of 4 mm thickness. Barcino Ø 60 cm with base of Ø 35 cm and tube of Ø 6 cm. Ø 60 table net weight 13 kg (28,66 lb). Barcino Ø 80 cm with base of Ø 45 cm and tube of Ø 8 cm. Ø 80 table net weight 22 kg (48,50 lb).

Table pour usage intérieur et extérieur. Structure en aluminium anodisé peinte par pulvérisation et séchée au four. Plateau de 4 mm de gressueur. Barcino Ø 60 cm avec base de Ø 35 cm et tube de Ø 6 cm. Poids net table Ø 60, 13 kg. Barcino Ø 80 cm avec base de Ø 45 cm et tube de Ø 8 cm. Poids net table Ø 80, 22 kg.

Ø 60 cm | Ø 23.62 in
H 74 cm | H 29.13 in

Ø 80 cm | Ø 31.49 in
H 74 cm | H 29.13 in

W: ancho / width / largeur. L: largo / length / longueur
H: altura / height / hauteur. Hs: altura asiento / seat height / hauteur du siège. Ha: altura brazo / arm height / hauteur du bras
Ø: diámetro / diameter / diamètre.

STD units	Packaging dim. (cm)	M3/ pack	NW units (kg)	Units Container 20'	Units Container 40'	Units Container HC	Units Truck 70m ³	Units Truck 100m ³
1	62x62x13	0,05	13	220	500	500	600	-
1	82x82x15	0,10	22	220	440	440	-	-

SPUTNIK

JOSEP LLUSCÀ

Pie
Pedestal base
Pied

Blanco | White | Blanc

Rojo | Red | Rouge

Negro | Black | Noir

Acabados tubos | Tubes finishes |
Finition du tube

Aluminio brillante | Shiny Aluminium |
Aluminium brillant

Aluminio mate | Matt Aluminium |
Aluminium mat

Aluminio pintado blanco |
White painted Aluminium |
Aluminium peint en blanc

Aluminio pintado negro |
Black painted Aluminium |
Aluminium peint en noir



Pie central simple para uso interior y exterior. El pie se compone de dos partes, una carcasa inyectada en poliamida y un contrapeso de hierro pintado. Tubo de aluminio anodizado de \varnothing 60 x 2 mm. de grosor en acabado brillante, mate o pintado blanco o negro. Protección contra rayos UV. Nivelador en una pata. Consultar tabla de combinaciones de pie y sobres en pág. 162.

Single pedestal base for indoor and outdoor use. The base is composed of two pieces, a casing injected with polyamide and a painted iron counterweight. Anodized aluminium tube, \varnothing 60 x 2 mm thick, shiny, matt or white or black painted finish. UV protection. Leveller in one leg. See table combination for pedestal bases and table tops on p. 162.

Pied central simple d'intérieur et extérieur. Pied central fait en deux partis, une carcasse injectée en polyamide et un contrepoids en fer, peint. Tube en aluminium anodisé brillant ou mat, ou tube en aluminium peint blanc ou noir de \varnothing 60 x 2 mm de grosseur. Protection contre les rayons UV. Niveleur sur un pied. Voir table de combinaisons entre pied central et plateau à la page 162.

W 52 cm | W 20.47 in
L 52 cm | L 20.47 in
H 68,5 cm | H 26.97 in

W: ancho / width / largeur. L: largo / length / longueur
H: altura / height / hauteur. Hs: altura asiento / seat height /
hauteur du siège. Ha: altura brazo / arm height / hauteur du bras
Ø: diámetro / diameter / diamètre.

STD units	Packaging dim. (cm)	M3/ pack	NW units (kg)	Units Container 20'	Units Container 40'	Units Container HC	Units Truck 70m ²	Units Truck 100m ²
1	55x53x17	0,05	4,415	565	1.171	1.320	1.414	2.020

SPUTNIK

JOSEP LLUSCÀ

Pie doble
Double pedestal base
Double pied

○ Blanco | White | Blanc

● Rojo | Red | Rouge

● Negro | Black | Noir

Acabados tubos | Tubes finishes |
Finition du tube

● Aluminio brillante | Shiny Aluminium |
Aluminium brillant

● Aluminio mate | Matt Aluminium |
Aluminium mat

○ Aluminio pintado blanco |
White painted Aluminium |
Aluminium peint en blanc

● Aluminio pintado negro |
Black painted Aluminium |
Aluminium peint en noir



Pie central doble para uso interior y exterior. El pie se compone de dos partes, una carcasa inyectada en poliamida y un contrapeso de hierro pintado. Tubo de aluminio anodizado de $\varnothing 60 \times 2$ mm. de grosor en acabado brillante, mate o pintado blanco o negro. Protección contra rayos UV. Nivelador en una pata. Consultar tabla de combinaciones de pie y sobres en pág. 162.

Double pedestal base for indoor and outdoor use. The base is composed of two pieces, a casing injected with polyamide and a painted iron counterweight. Anodized aluminium tube, $\varnothing 60 \times 2$ mm thick, shiny, matt or white or black painted finish. UV protection. Leveller in one leg. See table combination for pedestal bases and table tops on p. 162.

Pied central double d'intérieur et extérieur. Pied central fait en deux parties, une carcasse injectée en polyamide et un contrepoids en fer, peint. Tube en aluminium anodisé brillant ou mat, ou tube en aluminium peint blanc ou noir de $\varnothing 60 \times 2$ mm de grosseur. Protection contre les rayons UV. Niveleur sur un pied. Voir table de combinaisons entre pied central et plateau à la page 162.

W 52 cm | W 20.47 in
L 52 cm | L 20.47 in
H 68,5 cm | H 26.97 in

W: ancho / width / largeur. L: largo / length / longueur
H: altura / height / hauteur. Hs: altura asiento / seat height /
hauteur du siège. Ha: altura brazo / arm height / hauteur du bras
Ø: diámetro / diameter / diamètre.

STD units	Packaging dim. (cm)	M3/ pack	NW units (kg)	Units Container 20'	Units Container 40'	Units Container HC	Units Truck 70m ³	Units Truck 100m ³
1	72x102x15	0,11	7,84	248	514	583	621	887

Sillas con brazos Fiona (p. 64), mesa Sputnik con tablero Werzalit (p. 136)

Fiona armchairs (p. 64), Sputnik table with Werzalit top (p. 136)

Fauteuils Fiona (p. 64), table Sputnik avec Werzalit plateau (p. 136)





NET

LLUÍS CODINA

Pie
Pedestal base
Pied

○ Blanco | White | Blanc

● Negro | Black | Noir



Pie central para uso interior y exterior. Pie en inyección de aluminio pintado blanco y negro. Protección contra rayos UV. Consultar tabla de combinaciones de pie y sobres en pág. 162.

Pedestal base for indoor and outdoor use. Cast aluminium pedestal base, white and black painted. UV protection. See table combination for pedestal bases and table tops on p. 162.

Pied central d'intérieur et extérieur. Pied central injecté en aluminium peint en blanc et noir. Voir le tableau de combinaison pour pied central et plateau pag. 162.



Base 50,30 x 51 x 44 x 46 cm
H 69,20 cm

Base 19.80 x 20.08x 17.32 x 18.11 in
H 27.24 in

W: ancho / width / largeur. L: largo / length / longueur
H: altura / height / hauteur. Hs: altura asiento / seat height /
hauteur du siège. Ha: altura brazo / arm height / hauteur du bras
Ø: diámetro / diameter / diamètre.

STD units	Packaging dim. (cm)	M3/ pack	NW units (kg)	Units Container 20'	Units Container 40'	Units Container HC	Units Truck 70m ²	Units Truck 100m ²
1	55x53x17	0,05	16,2	565	1.171	1.320	1.414	2.020

Sillas con brazos Fiona (p. 61), pie Net con sobre de HPL blanco (p. 140)

Fiona armchairs (p. 61), Net base with white HPL top (p. 140)

Fauteuils Fiona (p. 61), pied Net avec blanc HPL plateau (p. 140)



VELA S

FABRIZIO BATONI

Pie
Pedestal base
Pied

- Blanco | White | Blanc
- Negro | Black | Noir
- Rojo | Red | Rouge
- Arena | sand | sable

 Certificados | Certificates | Certificats

Vela pedestal base Test Certificates:
EN 15372 L3



Pie central para uso interior y exterior compuesto por dos bases inyectadas en fibra de vidrio con PP mediante tecnología de moldeo asistida por gas, unidas por una barra de aluminio. Protección UV. Peso neto 4 kg. Pie compatible con sobres de compacto fenólico y cristal templado de 70 x 70, 80 x 80, 90 x 90, Ø70, Ø80 y Ø90. Ver tabla de combinaciones en página 162.

Pedestal base for indoor and outdoor use, composed by two bases injected in fiberglass with PP using gas assisted injection moulding technology, joined by an aluminium bar. UV Protection. Net weight 4 kg (8.82 lb). Compatible base with HPL and tempered glass table tops of 70 x 70, 80 x 80, 90 x 90, Ø70, Ø80 and Ø90 cm. See table combinations on page 162.

Pied central pour usage intérieur et extérieur, composé par deux bases injectées en fibre de verre avec PP, en utilisant technologie de moulage assistée par gaz, unies par une barre en aluminium. Protection UV. Poids net 4 kg. Pied compatible avec plateaux de résine phénolique et verre trempé de 70 x 70, 80 x 80, 90 x 90, Ø70, Ø80 y Ø90. Voir table de combinaisons à la page 162.

W 61,5 cm | W 24.21 in
L 60 cm | L 23.62 in
H 72,5 cm | H 28.54 in

W: ancho / width / largeur. L: largo / length / longueur
H: altura / height / hauteur. Hs: altura asiento / seat height / hauteur du siège. Ha: altura brazo / arm height / hauteur du bras
Ø: diámetro / diameter / diamètre.

STD units	Packaging dim. (cm)	M3/pack	NW units (kg)	Units Container 20'	Units Container 40'	Units Container HC	Units Truck 70m³	Units Truck 100m³
1	83x74x27	0,17	4	-	312	-	360	-



Sillas Carla (p. 80), mesa Vela S con HPL blanco (p. 142)

Carla chairs (p. 80), table Vela S with white HPL (p. 142)

Carla chaises (p. 80), table Vela S avec HPL blanc (p. 142) 143

VELA M

FABRIZIO BATONI

Pie
Pedestal base
Pied

- Blanco | White | Blanc
- Negro | Black | Noir
- Rojo | Red | Rouge
- Arena | sand | sable

 Certificados | Certificates | Certificats

Vela pedestal base Test Certificates:
EN 15372 L3

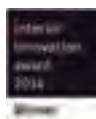

Pie central doble para uso interior y exterior compuesto por dos bases inyectadas en fibra de vidrio con PP mediante tecnología de moldeo asistida por gas, enlazadas entre sí por una barra de aluminio cubierto por un perfil de pvc texturizado. Protección UV. Peso neto 4,65 kg. Base compatible con sobres de compacto fenólico de 120 x 80 y cristal templado de 120 x 80 y de 150 x 110 ovalado. Ver tabla de combinaciones en página 162.

Double pedestal base for indoor and outdoor use, composed by two bases injected in fibreglass with PP using gas assisted injection moulding technology, joined by an aluminium bar covered by a textured pvc profile. UV Protection. Net weight 4,65 kg (10.25 lb). Compatible base with HPL of 120 x 80 and tempered glass table tops of 120 x 80 cm and 150 x 110 oval. See table combinations on page 162.

Double pied central pour usage intérieur et extérieur, composé par deux bases injectées en fibre de verre avec PP, en utilisant technologie de moulage assistée par gaz, unies par une barre en aluminium couverte avec un profil de pvc texturé. Protection UV. Poids net 4,65 kg. Pied compatible avec plateaux de résine phénolique de 120 x 80 et verre trempé de 120 x 80 et 150 x 110 ovale. Voir table de combinaisons à la page 162.

W 61,5 cm	W 24.21 in
L 79 cm	L 31.10 in
H 72,5 cm	H 28.54 in

W: ancho / width / largeur. L: largo / length / longueur
H: altura / height / hauteur. Hs: altura asiento / seat height / hauteur du siège. Ha: altura brazo / arm height / hauteur du bras
Ø: diámetro / diameter / diamètre.

STD units	Packaging dim. (cm)	M3/pack	NW units (kg)	Units Container 20'	Units Container 40'	Units Container HC	Units Truck 70m³	Units Truck 100m³
1	83x74x27	0,16	4,65	-	-	-	-	-

VELA L

FABRIZIO BATONI

Pie
Pedestal base
Pied

- Blanco | White | Blanc
- Negro | Black | Noir
- Rojo | Red | Rouge
- Arena | sand | sable

 Certificados | Certificates | Certificats

Vela pedestal base Test Certificates:
EN 15372 L3

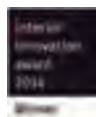

Pie central doble para uso interior y exterior compuesto por dos bases inyectadas en fibra de vidrio con PP mediante tecnología de moldeo asistida por gas, enlazadas entre sí por una barra de aluminio cubierto por un perfil de pvc texturizado. Protección UV. Peso neto 5,9 kg. Base compatible con sobres de compacto fenólico de 180 x 90 y 200 x 90, y cristal templado de 180 x 90 cm. Ver tabla de combinaciones en página 162.

Double pedestal base for indoor and outdoor use, composed by two bases injected in fibreglass with PP using gas assisted injection moulding technology, joined by an aluminium bar covered by a textured pvc profile. UV Protection. Net weight 5,9 kg (13 lb). Compatible base with HPL table tops of 180 x 90 and 200 x 90, and tempered glass table tops of 180 x 90 cm. See table combinations on page 162.

Pied central double pour usage intérieur et extérieur, composé par deux bases injectées en fibre de verre avec PP, en utilisant technologie de moulage assistée par gaz, unies par une barre en aluminium couverte avec un profil de pvc texturé. Protection UV. Poids net 5,9 kg. Pied compatible avec plateaux de résine phénolique de 180 x 90 et 200 x 90, et de verre trempé de 180 x 90. Voir table de combinaisons à la page 162.

W 61,5 cm	W 24.21 in
L 142 cm	L 55.91 in
H 72,5 cm	H 28.54 in

W: ancho / width / largeur. L: largo / length / longueur
H: altura / height / hauteur. Hs: altura asiento / seat height / hauteur du siège. Ha: altura brazo / arm height / hauteur du bras
Ø: diámetro / diameter / diamètre.

STD units	Packaging dim. (cm)	M3/pack	NW units (kg)	Units Container 20'	Units Container 40'	Units Container HC	Units Truck 70m ³	Units Truck 100m ³
1	83x74x27	0,16	5,9	-	-	-	-	-

BARCINO

JOAN GASPAR

Mesa apilable
Stackable table
Table empilable

 Apilable
10u. Stackable | Empilable

Personalización de colores disponible bajo pedido y sujetos a cantidades mínimas. Consulte el Departamento Comercial.

Colour customization is available upon request. Minimum orders are applicable. Contact the Sales Department.

Personnalisation de couleurs disponible sur commande. Quantités minimales à appliquer. Consultez le Département Commerciale.

- Arena | sand | sable
- Negro | Black | Noir
- Blanco | White | Blanc

 Certificados | Certificates | Certificats

Barcino table Test Certificates:
UNE N 581 PUBLIC



Mesa apilable para uso interior y exterior. Estructura de aluminio anodizado pintado por pulverización y secado al horno de 40 x 40 mm y 1,50 mm de grosor. Sobre de 3 mm de grosor. Peso neto mesa 70 x 70, 8 kg. Peso neto mesa 90x90, 11 kg.

Stackable table for indoor and outdoor use. Powder coated anodized aluminium frame and oven-drying 40 x 40 mm and 1,50 mm thick. Table top of 3 mm thickness. 70 x 70 table net weight 8 kg (17.64 lb). 90 x 90 table net weight 11 kg (24,26 lb).

Table empilable pour usage intérieur et extérieur. Structure en aluminium anodisé peinte par pulvérisation et séchée au four 40 x 40 mm et 1,50 mm de grosseur. Plateau de 3 mm de grosseur. Poids net table 70 x 70 8 kg. Poids net table 90 x 90 11 kg.

W 70 cm | W 27.56 in
L 70 cm | L 27.56 in
H 74 cm | H 29.13 in

W 90 cm | W 35.43 in
L 90 cm | L 35.43 in
H 74 cm | H 29.13 in

W: ancho / width / largeur. L: largo / length / longueur
H: altura / height / hauteur. Hs: altura asiento / seat height / hauteur du siège. Ha: altura brazo / arm height / hauteur du bras
Ø: diámetro / diameter / diamètre.

STD units	Packaging dim. (cm)	M3/ pack	NW units (kg)	Units Container 20'	Units Container 40'	Units Container HC	Units Truck 70m ³	Units Truck 100m ³
1	80x89x120	0,58	8	200	480	480	520	600
20	100x100x220	2,2	8	200	480	480	520	600
1	100x89x120	1,07	11	200	480	480	520	600
20	120x120x220	3,6	11	200	480	480	520	600

BARCINO COMPACT

JOAN GASPAR

Mesa Apilable
Stackable table
Table empilable

 Apilable
10u. Stackable | Empilable

Personalización de colores disponible bajo pedido y sujetos a cantidades mínimas. Consulte el Departamento Comercial.

Colour customization is available upon request. Minimum orders are applicable. Contact the Sales Department.

Personnalisation de couleurs disponible sur commande. Quantités minimales à appliquer. Consultez le Département Commerciale.

 Estructura | Structure | Structure

Blanco | White | Blanc
 Negro | Black | Noir

Tablero | Table top | Plateau

Blanco | White | Blanc
 Negro | Black | Noir
 Madera lavada | Washed wood | Bois délavé
 Roble natural | Natural oak | Chêne naturele
 Roble ceniza | Ashen oak | Chêne cendré

W 70 cm | W 27.56 in
L 70 cm | L 27.56 in
H 74 cm | H 29.13 in

W: ancho / width / largeur. L: largo / length / longueur
H: altura / height / hauteur. Hs: altura asiento / seat height / hauteur du siège. Ha: altura brazo / arm height / hauteur du bras
Ø: diámetro / diameter / diamètre.



Mesa apilable para uso interior y exterior. Estructura de aluminio anodizado pintado por pulverización y secado al horno de 40 x 40 mm y 1,50 mm de grosor. Tablero de compacto fenólico de 10 mm de grosor. Peso neto 10,68 kg.

Stackable table for indoor and outdoor use. Powder coated anodized aluminium frame and oven-drying 40 x 40 mm and 1,50 mm thick. Table top of HPL of 10 mm thickness. Net weight (10,68 kg) 23.55 lb.

Table empilable pour usage intérieur et extérieur. Structure en aluminium anodisé peinte par pulvérisation et séchée au four 40 x 40 mm et 1,50 mm de grosseur. Plateau en résine phénolique de 10 mm de grosseur. Poids net 10,68 kg.

STD units	Packaging dim. (cm)	M3/ pack	NW units (kg)	Units Container 20'	Units Container 40'	Units Container HC	Units Truck 70m³	Units Truck 100m³
1	80x89x120	0,85	10,68	180	432	432	468	540
18	100x100x220	2,2	10,68	180	432	432	468	540

CORNER

BARCELONA Dd

Pie
Pedestal
Pied

 Apilable
Stackable | Empilable

- Blanco | White | Blanc
- Arena | Sand | Sable
- Gris Oscuro | Dark Grey | Gris Foncé







Mesa Corner con patas inyectadas en polipropileno con fibra de vidrio mediante tecnología de moldeo asistida por gas. Altura 73,5 cm. Combinables con sobre de compacto fenólico en distintas medidas. Posibilidad en 3 o 4 patas según medida del sobre.

Corner table with legs injected in polypropylene with fiberglass using gas assisted molding technology. High 73,5 cm (28.93 in). Combinables with HPL top in different sizes. Possibility in 3 or 4 legs according to the size of the top.

Table Corner avec pieds injectés en polypropylène et fibre de verre à travers la technologie de moulage assistée par gaz. Hauteur 73,5 cm. Combinables avec des plateaux en compact phénolique de différentes dimensions. Possibilité de 3 ou 4 pieds selon la dimension du plateau.

STD units	Packaging dim. (cm)	M3/pack	NW units (kg)	Units Container 20'	Units Container 40'	Units Container HC	Units Truck 70m³	Units Truck 100m³
3 Legs	84x83x17	0,12	3,6	765	1.575	1.800	2.100	2.400
4 Legs	84x83x17	0,12	4,8	1.020	2.100	2.400	2.800	3.200

COMBINACIONES DE MESAS | TABLE COMBINATIONS | COMBINAISONS DE TABLES

Medidas Measurements Mesures	Ø 60	Ø 70	Ø 80	Ø 90	70x70	80x80	90x90	120x80
Material Material Matériel								
Patas legs pieds	3	3	4	4	4	4	4	4
HPL 	•	•			•			
	•	•			•			
HPL MADERA HPL Wood HPL Bois								
A 	•	•	•	•	•	•	•	•
B 	•	•	•	•	•	•	•	•
C 	•	•	•	•	•	•	•	•

- A - Roble natural | natural oak | chêne naturel
 B - Roble ceniza | ashen oak | chêne cendré
 C - Madera lavada | Washed wood | Bois delavé





Silla Toledo Aire (p. 26), mesa Corner (p. 148)
Toledo Aire chair (p. 26), Corner table (p. 148)
Chaise Toledo Aire (p. 26), table Corner (p. 148)

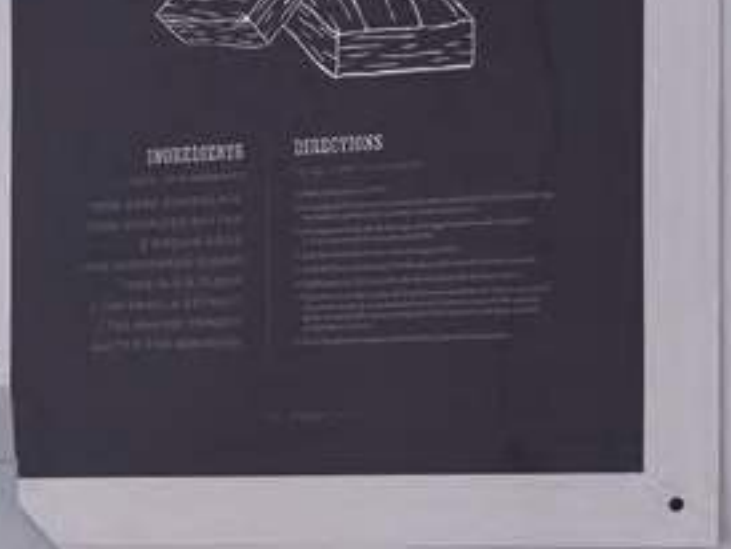

POINT

JOAN GASPAR

Mesa
Table
Table

 Apilable
10u. Stackable | Empilable

- Blanco/Rojo | White/Red | Blanc/Rouge
- Blanco/Negro | White/Black | Blanc/Noir
- Blanco | White | Blanc



 Certificados | Certificats | Certificats

Point table Test Certificates:
EN 16139 L1 / EN 581 PUBLIC



Mesa para uso interior y exterior. El sobre se compone de 2 partes inyectadas en PP. Estructura tubular de acero pintado por pulverización al horno, disponible en color blanco. Apilable. Protección UV. Peso neto 70 x 70: 10,66 kg y peso neto 80 x 80: 12 kg.

Table for indoor and outdoor use. The table top is composed by two layers injected in PP. Tubular powder coated steel structure, available in white. Stackable. UV protection. Net Weight 70 x 70: 10,66 kg (23.50 lb) and net weight 80 x 80: 12 kg (26.46 lb).

Table d'intérieur et extérieur. Le plateau est fait en deux parties injectées en PP. Structure tubulaire en acier peint par pulvérisation, disponible en couleur blanche. Empilable. Protection UV. Poids net 70 x 70: 10,66 kg et poids net 80 x 80: 12 kg.

W 70 cm | W 27.56 in
L 70 cm | L 27.56 in
H 70,5 cm | H 27.76 in

W 80 cm | W 31.50 in
L 80 cm | L 31.50 in
H 70,5 cm | H 27.76 in

W: ancho / width / largeur. L: largo / length / longueur
H: altura / height / hauteur. Hs: altura asiento / seat height / hauteur du siège. Ha: altura brazo / arm height / hauteur du bras
Ø: diámetro / diameter / diamètre.

STD units	Packaging dim. (cm)	M3/ pack	NW units (kg)	Units Container 20'	Units Container 40'	Units Container HC	Units Truck 70m³	Units Truck 100m³
15	110x110x210	2,54	10,66	150	300	330	360	390
15	110x110x210	2,54	12	150	300	330	360	390



Sillas Sun (p. 121) con mesa Point (p. 152)
Sillas Sun (p. 121) con mesa Point (p. 152)
Chaises Sun (p. 121) avec table Point (p. 152)

NOA

DAVID CARRASCO BARCELÓ

Mesa
Table
Table

Sobre + patas | Table + legs |
Plateau + pieds

- Blanco | White | Blanc
- Arena | Sand | Sable
- Arena/Blanco | Sand/White | Sable/Blanc
- Gris Oscuro | Dark Grey | Gris Foncé
- Gris Oscuro/Blanco | Dark Grey/White | Gris Foncé/Blanc
- Rojo | Red | Rouge
- Chocolate | Chocolate | Chocolat
- Chocolate/ Blanco | Chocolate/ White | Chocolat/ Blanc



Certificados | Certificates | Certificats

Noa Table Test Certificates:
EN 581-1 / 581-3 PUBLIC



Mesa para uso interior y exterior inyectada en polipropileno y reforzada con fibra de vidrio en las patas. Protección UV. Disponible en dos medidas: 90x90, peso neto 11,85 kg (26.12 lb), 160 x 90, peso neto 21,65 kg (47.73 lb).

Table for indoor and outdoor use injected in polypropylene and reinforced with fiberglass in the legs. UV protection. Available in 2 sizes: 90x90, net weight 11,85 kg (26.12 lb), 160 x 90, net weight 21,65 kg (47.73 lb).

Table pour usage intérieur et extérieur injecté en polypropylène et renforcé de fibre de verre dans les pieds. Protection UV. Disponible en deux dimensions: 90x90, poids net 11,85 kg (26.12 lb), 160 x 90, poids net 21,65 kg (47.73 lb).

W 90 cm | W 35.43 in
L 90 cm | L 35.43 in
H 74 cm | H 29.13 in

W 90 cm | W 35.43 in
L 160 cm | L 62.99 in
H 74 cm | H 29.13 in

W: ancho / width / largeur. L: largo / length / longueur
H: altura / height / hauteur. Hs: altura asiento / seat height / hauteur du siège. Ha: altura brazo / arm height / hauteur du bras
Ø: diámetro / diameter / diamètre.

STD units	Packaging dim. (cm)	M3/ pack	NW units (kg)	Units Container 20'	Units Container 40'	Units Container HC	Units Truck 70m³	Units Truck 100m³
1	94x92x15	0,13	12,07	180	390	442	448	578
24	100x100x220	2,2	11,85	240	240	576	624	720
1	161x92x15	0,22	18,27	90	210	238	256	323
24	100x160x220	3,52	21,65	168	384	384	408	504



Sillas y sillas con brazos Ona (p. 110-111), mesa Noa (p. 154)
Ona chairs and armchairs (p. 110-111), Noa table (p. 154)
Fauteuils et chaises Ona (p. 110-111), Noa table (p. 154)

NEW DESSA

BARCELONA Dd

Mesa
Table
Table

- Blanco | White | Blanc
- Chocolate | Chocolate | Chocolat
- Arena | Sand | Sable
- Gris Oscuro | Dark Grey | Gris Foncé

Certificados | Certificates | Certificats

New Dessa Table Test Certificates:
EN 581 PUBLIC



Mesa para uso interior y exterior. Sobre y patas inyectados en polipropileno. Estructura de acero zincado pintada por pulverización al horno testado conforme normativa anticorrosión UNE EN/ISO 9227:2012. Protección UV. Disponible en 2 medidas: 90 x 90, peso neto 11,74 kg, 160 x 90, peso neto 16,75 kg.

Table for indoor and outdoor use. Table top and legs injected in polypropylene. Powder coated zink steel structure in accordance to corrosion regulation UNE EN/ISO 9227:2012. UV protection. Available in 2 sizes: 90 x 90, net weight 11,74 kg (25.88 lb), 160 x 90, net weight 16,75 kg (36,93 lb).

Table pour usage intérieur et extérieur. Plateau et pieds injectés en polypropylène. Structure d'acier zingué peint par pulvérisation au four en conformité avec la réglementation anticorrosion UNE EN/ISO 9227:2012. Disponible dans 2 mesures: 90 x 90, poids net 11,74 kg, 160 x 90, poids net 16,75 kg.

W 90 cm	W 35.43 in
L 90 cm	L 35.43 in
H 74 cm	H 29.13 in

W 90 cm	W 35.43 in
L 160 cm	L 62.99 in
H 74 cm	H 29.13 in

W: ancho / width / largeur. **L:** largo / length / longueur
H: altura / height / hauteur. **Hs:** altura asiento / seat height / hauteur du siège. **Ha:** altura brazo / arm height / hauteur du bras
Ø: diámetro / diameter / diamètre.

STD units	Packaging dim. (cm)	M3/ pack	NW units (kg)	Units Container 20'	Units Container 40'	Units Container HC	Units Truck 70m³	Units Truck 100m³
1	94x92x15	0,13	11,74	180	390	442	448	578
1	161x92x15	0,22	16,75	90	210	238	256	323

NEW FLASH

BARCELONA Dd

Mesa
Table
Table

- Blanco | White | Blanc
- Chocolate | Chocolate | Chocolat
- Arena | Sand | Sable
- Gris Oscuro | Dark Grey | Gris Foncé

 Certificados | Certificates | Certificats

New Flash Table Test Certificates:
EN 581 PUBLIC



Mesa para uso interior y exterior. Sobre inyectado en polipropileno. Patas de aluminio anodizado de alta resistencia. Estructura de acero zincado pintada por pulverización al horno testeado conforme normativa anticorrosión UNE EN/ISO 9227:2012. Protección UV. Disponible en 2 medidas: 90 x 90, peso 11,58 kg, 160 x 90, peso 16,59 kg.

Table for indoor and outdoor use. Table top injected with polypropylene. High resistance anodized aluminium legs. Powder coated zinc steel structure in accordance to corrosion regulation UNE EN/ISO 9227:2012. UV Protection. Available in two sizes: 90 x 90, weight 11,58 kg (25.53 lb), 160 x 90, weight 16,59 kg (36,57 lb).

Table d'intérieur et extérieur. Plateau injecté en polypropylène. Pieds en aluminium anodisé de haute résistance. Structure d'acier zingué peint par pulvérisation au four en conformité avec la réglementation anticorrosion UNE EN/ISO 9227:2012. Protection UV. Disponible dans 2 mesures: 90 x 90, poids 11,58 kg, 160 x 90, poids 16,59 kg.

W 90 cm | W 35.43 in
L 90 cm | L 35.43 in
H 74 cm | H 29.13 in

W 90 cm | W 35.43 in
L 160 cm | L 62.99 in
H 74 cm | H 29.13 in

W: ancho / width / largeur. L: largo / length / longueur
H: altura / height / hauteur. Hs: altura asiento / seat height / hauteur du siège. Ha: altura brazo / arm height / hauteur du bras
Ø: diámetro / diameter / diamètre.

STD units	Packaging dim. (cm)	M3/ pack	NW units (kg)	Units Container 20'	Units Container 40'	Units Container HC	Units Truck 70m ³	Units Truck 100m ³
1	94x92x15	0,13	11,58	180	390	442	448	578
1	161x92x15	0,22	16,59	90	210	238	256	323

BARCINO

JOAN GASPAR

Mesa pie central alto
High pedestal base table
Table pied central haute

Personalización de colores disponible bajo pedido y sujetos a cantidades mínimas. Consulte el Departamento Comercial.

Colour customization is available upon request. Minimum orders are applicable. Contact the Sales Department.

Personnalisation de couleurs disponible sur commande. Quantités minimales à appliquer. Consultez le Département Commerciale.

- Arena | sand | sable
- Negro | Black | Noir
- Blanco | White | Blanc

 **Certificados** | Certificates | Certificats

Barcino table Test Certificates:
EN 581 PUBLIC



Mesa alta para uso interior y exterior. Estructura de aluminio anodizado pintado por pulverización y secado al horno. Sobre de 4 mm de grosor. Base de Ø 35 cm y tubo de Ø 6 cm. Peso neto mesa 14 kg.

High table for indoor and outdoor use. Powder coated anodized aluminium frame and oven-drying. Table top of 4 mm thickness. Base of Ø 35 cm and tube of Ø 6 cm. Table net weight 14 kg (30.86 lb).

Table pour usage intérieur et extérieur. Structure en aluminium anodisé peinte par pulvérisation et séchée au four. Plateau de 4 mm de grosseur. Base de Ø 35 cm avec tube de Ø 6 cm. Poids net table 14 kg.

Ø 60 cm | Ø 23.62 in
H 110 cm | H 43.31 in

W: ancho / width / largeur. **L:** largo / length / longueur
H: altura / height / hauteur. **Hs:** altura asiento / seat height / hauteur du siège. **Ha:** altura brazo / arm height / hauteur du bras
Ø: diámetro / diameter / diamètre.

STD units	Packaging dim. (cm)	M3/ pack	NW units (kg)	Units Container 20'	Units Container 40'	Units Container HC	Units Truck 70m³	Units Truck 100m³
1	62x62x13	0,05	14	297	675	675	800	-

SPUTNIK

JOSEP LLUSCÀ

Pie alto
High pedestal base
Pied haut

- Blanco | White | Blanc
- Rojo | Red | Rouge
- Negro | Black | Noir

Acabados tubos | Tubes finishes |
Finition du tube

- Aluminio brillante | Shiny Aluminium |
Aluminium brillant
- Aluminio mate | Matt Aluminium |
Aluminium mat
- Aluminio pintado blanco |
White painted Aluminium |
Aluminium peint en blanc
- Aluminio pintado negro |
Black painted Aluminium |
Aluminium peint en noir



Pie central alto para uso interior y exterior. El pie se compone de dos partes, una carcasa inyectada en poliamida y un contrapeso de hierro pintado. Tubo de aluminio anodizado de $\varnothing 60 \times 2$ mm. de grosor en acabado brillante, mate o pintado blanco o negro. Protección contra rayos UV. Nivelador en una pata. Consultar tabla de combinaciones de pie y sobres en pág. 162.

High pedestal base for indoor and outdoor use. The base is composed of two pieces, a casing injected with polyamide and a painted iron counterweight. Anodized aluminium tube, $\varnothing 60 \times 2$ mm thick, shiny, matt or white or black painted finish. UV protection. Leveller in one leg. See table combination for pedestal bases and table tops on p. 162.

Pied central haut d'intérieur et extérieur. Pied central fait en deux partis, une carcasse injectée en polyamide et un contrepoids en fer, peint. Tube en aluminium anodisé brillant ou mat, ou tube en aluminium peint blanc ou noir de $\varnothing 60 \times 2$ mm de grosseur. Protection contre les rayons UV. Niveleur sur un pied. Voir table de combinaisons entre pied central et plateau à la page 162.

W 52 cm | W 20.47 in
L 52 cm | L 20.47 in
H 107 cm | H 42.12 in

W: ancho / width / largeur. L: largo / length / longueur
H: altura / height / hauteur. Hs: altura asiento / seat height /
hauteur du siège. Ha: altura brazo / arm height / hauteur du bras
Ø: diámetro / diameter / diamètre.

STD units	Packaging dim. (cm)	M3/ pack	NW units (kg)	Units Container 20'	Units Container 40'	Units Container HC	Units Truck 70m ³	Units Truck 100m ³
1	box 1: 53x55x17	0,075	6,78	350	725	822	875	1.250
	box 2: 96x7x7	0,005						

TABLERO COMPACTO FENÓLICO

HPL TABLE TOP

PLATEAU RÉSINE PHÉNOLIQUE

El compacto fenólico es un laminado de alta presión (HPL). Su composición consiste en capas de papel aglutinado con resinas termoestables de melamina-formaldehído en su superficie y de fenol-formaldehído en su interior. Todo ello es prensado a alta presión (≥ 7 MPa) y alta temperatura ($\geq 120^\circ\text{C}$), dando como resultado uno de los materiales más versátiles por su apariencia, estética, resistencia y durabilidad.

Su extraordinaria superficie está constituida por una hoja impregnada con resina de melamina-formaldehído, que es la que aporta el diseño. Por encima de este diseño decorativo lleva una hoja adicional (overlay), impregnada también en resina melamínica, que le aporta gran resistencia al rayado y la abrasión. Finalmente, el núcleo central, compuesto de papel kraft impregnado en resina fenólica, le dotan de gran resistencia al impacto. Tanto el overlay como el núcleo central de resina fenólica, son los dos elementos diferenciadores del laminado HPL.

El laminado HPL posee la cualidad de ser resistente al calor, al rayado, a la abrasión, impermeable e inerte debido a su superficie no porosa, lo cual lo hace apto para uso interior y exterior e ideal para uso contract.

HPL is a high pressure laminate (HPL). Its composition is bonded paper layers with thermosetting resins, melamine-formaldehyde on its surface and phenol-formaldehyde inside. All this is pressed at high pressure (≥ 7 MPa) and high temperature ($\geq 120^\circ\text{C}$), resulting in one of the most versatile materials in appearance, aesthetics, strength and durability.

Its extraordinary surface is constituted by a sheet impregnated with melamine-formaldehyde resin, which gives it a unique design. Above this decorative design it has an additional sheet (overlay) that's also impregnated with melamine resin, which makes it highly resistant to scratches and abrasion. Finally, the central core, consisting of kraft paper impregnated with phenolic resin, provide it with high impact resistance. Both the overlay and the core of phenolic resin are the two distinguishing features of HPL.

The HPL has the peculiarity of being resistant to heat, scratch, abrasion, waterproof and inert due to its non-porous surface, making it suitable for indoor and outdoor use and ideal for contract use.

La résine phénolique est un stratifié compact (HPL) de haute pression. Sa composition est constituée de couches de papier avec des résines thermodurcissables, des résines mélamine-formaldéhyde, sur sa surface et de phénol-formaldéhyde à l'intérieur. Tout cela est pressé à haute pression (≥ 7 MPa) et haute température ($\geq 120^\circ\text{C}$), résultant un des matériaux les plus polyvalents pour son apparence, esthétique, solidité et durabilité.

Sa surface extraordinaire est constituée par une feuille imprégnée de résine mélamine-formaldéhyde, qui elle même apporte son dessin. Au-dessus de ce dessin décoratif, s'ajoute une feuille supplémentaire (overlay) imprégnée de résine mélamine également, ce qui donne une haute résistance les rayures et l'abrasion. Enfin, le noyau central, composé de papier kraft imprégné de résine phénolique, lui permet une résistance aux chocs élevée. Autant la superposition comme le noyau de résine phénolique sont les deux traits distinctifs de HPL.

Le HPL a la qualité d'être résistant à la chaleur, aux égratignures, à l'abrasion, imperméable à l'eau et inerte en raison de sa surface non poreuse, ce qui convient pour usage intérieur et extérieur et idéal pour une utilisation contrat.

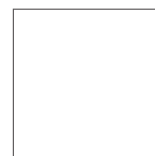

Blanco | White | Blanc



Negro | Black | Noir

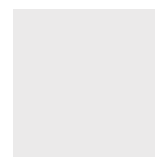

Plata | Silver | Argent

Ø 60 cm H 1 cm	Ø 23.62 in H 0.40 in	Ø 70 cm H 1 cm	Ø 27.56 in H 0.40 in
-------------------	-------------------------	-------------------	-------------------------

Ø 80 cm H 77,7 cm	Ø 31.49 in H 0.40 in	L60 cm W 60 cm H 1 cm	L 23.62 in W 23.62 in H 0.40 in
----------------------	-------------------------	-----------------------------	---------------------------------------

L 70 cm W 70 cm H 1 cm	L 27.56 in W 27.56 in H 0.40 in	L 80 cm W 80 cm H 1 cm	L 31.49 in W 31.49 in H 0.40 in
------------------------------	---------------------------------------	------------------------------	---------------------------------------

L 90 cm W 90 cm H 1 cm	L 35.43 in W 35.43 in H 0.40 in	L 120 cm W 80 cm H 1 cm	L 47.24 in W 31.49 in H 0.40 in
------------------------------	---------------------------------------	-------------------------------	---------------------------------------

L 180 cm W 90 cm H 1 cm	L 70.87 in W 35.43 in H 0.40 in	L 200 cm W 90 cm H 1 cm	L 78.74 in W 35.43 in H 0.40 in
-------------------------------	---------------------------------------	-------------------------------	---------------------------------------



Madera lavada | Washed Wood | Bois Delavé



Roble Ceniza | Ashen Oak | Chêne Cendré



Roble Natural | Natural Oak | Chêne Naturel

L 70 cm W 60 cm H 1 cm	L 27.56 in W 23.62 in H 0.40 in	L 70 cm W 70 cm H 1 cm	L 27.56 in W 27.56 in H 0.40 in
------------------------------	---------------------------------------	------------------------------	---------------------------------------

L 80 cm W 80 cm H 1 cm	L 31.49 in W 31.49 in H 0.40 in	L 90 cm W 90 cm H 1 cm	L 35.43 in W 35.43 in H 0.40 in
------------------------------	---------------------------------------	------------------------------	---------------------------------------

L 120 cm W 80 cm H 1 cm	L 47.24 in W 31.49 in H 0.40 in	L 180 cm W 90 cm H 1 cm	L 70.87 in W 35.43 in H 0.40 in
-------------------------------	---------------------------------------	-------------------------------	---------------------------------------

Ø 80 cm H 1 cm	Ø 34.49 in H 0.40 in
-------------------	-------------------------

Cualquier otro color bajo pedido y plazo de entrega. Consultar Departamento Comercial. Any other colour upon request, delivery time varies. Ask the Sales Department.

N'importe quelle couleur sur commande et délai de livraison. Consulter le Département Commercial.

TABLERO WERZALIT®

WERZALIT® TABLE TOP

PLATEAU WERZALIT®

Los tableros Werzalit se fabrican según un procedimiento patentado especialmente para su uso en interiores y exteriores. Debido al núcleo del material altamente triturado y prensado y con la superficie prensada homogéneamente con materiales derivados de la madera, los tableros Werzalit logran una larga vida útil, son sumamente sólidos y totalmente resistentes a la intemperie. No se recomienda exponer el werzalit en colores oscuros directamente al sol para evitar que se curve o deforme por efecto de la acumulación de calor.

Werzalit table tops are manufactured specially for use inside and outside using a patented procedure. Due to its high density material core manufactured from naturally grown wood and the surface pressed homogeneously with the wood material, Werzalit table tops are durable, hard-wearing and completely weatherproof. We do not recommend to expose dark werzalit table tops to the sun in order to avoid curving or deforming through the effect of heat accumulation.

Les plateaux de tables Werzalit sont fabriqués selon un procédé breveté en particulier pour un usage intérieur comme extérieur. Grâce à son noyau de haute densité avec particules de bois compressées et homogènes, les plateaux de tables Werzalit sont durables, robustes et absolument résistant aux intempéries. Nous recommandons de ne pas exposer les plateaux Werzalit foncés directement au soleil afin d'éviter qu'ils se courbent et se déforment par l'accumulation de chaleur.



Cualquier otro color bajo pedido y plazo de entrega. Consultar Departamento Comercial.

Any other colour upon request, delivery time varies. Ask the Sales Department.

N'importe quelle couleur sur commande et délai de livraison. Consulter le Département Commercial.



Otros colores o medidas, consultar con el departamento comercial.

For other colours or sizes please consult commercial department.

Plusieurs couleurs, consulter le département commercial.

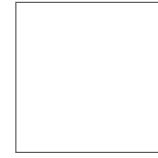

Blanco | White | Blanc

Ø 60 cm	Ø 23.62 in	W 60 cm L 60 cm	W 23.62 in L 23.62 in
---------	------------	--------------------	--------------------------

W 70 cm L 70 cm	W 27.56 in L 27.56 in	W 80 cm L 80 cm	W 31.49 in L 31.49 in
--------------------	--------------------------	--------------------	--------------------------

W 90 cm L 90 cm	W 35.43 in L 35.43 in	W 120 cm L 80 cm	W 47.24 in L 31.49 in
--------------------	--------------------------	---------------------	--------------------------

W 56,1 cm L 56,4 cm H 77,7 cm	W 22.09 in L 22.20 in H 30.59 in	W 56,1 cm L 56,4 cm H 77,7 cm	W 22.09 in L 22.20 in H 30.59 in
-------------------------------------	--	-------------------------------------	--



Stratos | Stratos | Stratos

Ø 60 cm	Ø 23.62 in	W 70 cm L 70 cm	W 27.56 in L 27.56 in
---------	------------	--------------------	--------------------------

W 80 cm L 80 cm	W 31.49 in L 31.49 in	W 120 cm L 80 cm	W 47.24 in L 31.49 in
--------------------	--------------------------	---------------------	--------------------------



Wengé | Wenge | Wenge

Ø 60 cm	Ø 23.62 in	W 70 cm L 70 cm	W 27.56 in L 27.56 in
---------	------------	--------------------	--------------------------

W 80 cm L 80 cm	W 31.49 in L 31.49 in	W 120 cm L 80 cm	W 47.24 in L 31.49 in
--------------------	--------------------------	---------------------	--------------------------

TABLERO DUROLIGHT

DUROLIGHT TABLE TOP

PLATEAU DUROLIGHT

Los tableros DUROLight son por su resistencia una opción idónea para el uso interior, y perfectamente combinable con la gama de sillas de Resol Contract. Están realizados de melamina con una imprimación de resina en la superficie que los protege de arañazos y de altas temperaturas (hasta 180°C). Los cantos están sellados con ABS para garantizar un acabado perfecto y resistente (Pruebas realizadas demuestran que son necesarios más de 1.5 Newton para conseguir arañar la superficie y 350 rotaciones para que se experimente desgaste.) Disponibles en color wengé, pino vintage y blanco.

The DUROLight tabletops are an ideal option for indoor use due to their resistance, and perfectly combinable with the range of Resol Contract. They are made of melamine with a resin coating on the surface, which protects them from scratches and high temperatures (up to 180°C). The edges are ABS sealed in order to guarantee a perfect and resistant finish. (Tests carried out showed that more than 1.5 Newton is necessary to achieve scratching the surface and 350 rotations in order to show wear.) Available in the colours wenge, vintage pine and white.

La résistance des planches DUROLight en fait l'option idéale pour un usage intérieur, et pouvant être parfaitement combinées avec la gamme de Resol Contract. Ils sont fabriqués en mélamine avec une couche de résine en surface protégeant des rayures et des hautes températures (jusqu'à 180°C) Les bords sont collés par ABS afin de garantir une finition parfaite et résistante. (Les tests réalisés démontrent qu'il faut plus de 1,5 Newton pour parvenir à rayer la surface et 350 rotations pour que l'usure commence.) Couleurs disponibles: wengé, pin vintage et blanc.

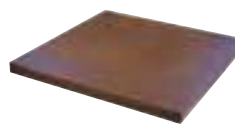

Standard
Wengé | Wenge | Wenge

W 68 cm	W 26.77 in	W 80 cm	W 31.49 in
L 68 cm	L 26.77 in	L 80 cm	L 31.49 in
H 5 cm	H 1.97 in	H 5 cm	H 1.97 in



Standard
Blanco | White | Blanc

W 68 cm	W 26.77 in	W 80 cm	W 31.49 in
L 68 cm	L 26.77 in	L 80 cm	L 31.49 in
H 5 cm	H 1.97 in	H 5 cm	H 1.97 in



Standard
Pino Vintage | Vintage Pine | Pin Vintage

W 68 cm	W 26.77 in	W 80 cm	W 31.49 in
L 68 cm	L 26.77 in	L 80 cm	L 31.49 in
H 5 cm	H 1.97 in	H 5 cm	H 1.97 in



Cualquier otro color bajo pedido y plazo de entrega. Consultar Departamento Comercial.

Any other colour upon request, delivery time varies. Ask the Sales Department.

N'importe quelle couleur sur commande et délai de livraison. Consulter le Département Commercial.



Standard: Acabado de Superficie de Melamina Decorativa + Revestimiento Protector Transparente.

① Standard: Decorative Melamine Surface Finish + Extra Transparent Overlay.

Standard: Finition de surface de mélamine décorative + revêtement protecteur transparent.

Aglomerado de 8 mm.

② 8 mm Chipboard layer.

Agglomérat de 8 mm.

Núcleo Interno Alveolar.

③ Internal Honeycomb core.

Noyau interne alvéolaire.

Canto de Unión de 3 mm de ABS inyectado.

④ 3 mm Support Edge of foamed ABS.











Bord d'union de 3 mm en ABS injecté.

Canto Decorativo de 2 mm de ABS.

⑤ 2 mm ABS Decor Edge.

Bord décoratif de 2 mm en ABS.

COMBINACIONES DE MESAS | TABLE COMBINATIONS | COMBINAISONS DE TABLES

Material Material Matériel	Medidas Measurements Mesures										
		Vela S	Vela M	Vela L	Net	Sputnik	Sputnik Alto	Sputnik Doble	Drop	Fall	Toledo Aire

HPL



Ø 60						•	•				
Ø 70	•					•			•	•	•
Ø 80	•					•			•	•	•
Ø 90	•										
Ø 100											
Ø 110											
Ø 120											
60 x 60						•					
70 x 70	•				•				•	•	•
80 x 80	•				•				•	•	•
90 x 90	•				•						
120 x 80			•					•			
180 x 90				•							
200 x 90				•							

HPL MADERA

HLP Wood
HLP bois

Roble natural
natural oak
chêne naturel



Roble ceniza
ashen oak
chêne cendré



Madera lavada
Washed wood
Bois délavé



Ø 80	•					•			•	•	•
Ø 90	•										
70 x 60	•					•			•	•	
70 x 70	•					•			•	•	•
80 x 80	•								•	•	•
90 x 90	•										
120 x 80			•					•			
180 x 90				•							

WERZALIT

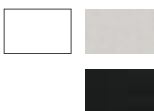

Ø 60						•	•				
60 x 60						•					
70 x 70						•					
80 x 80											
90 x 90											
120 x 80								•			

DUROLIGHT



68 x 68						•					
80 x 80											

CRISTAL TEMPLADO



Ø 70	•										
Ø 80	•								•	•	
Ø 90	•										
70 x 70	•										
80 x 80	•										
90 x 90	•										
120 x 80			•								
150 x 110			•								
180 x 90				•							

Las combinaciones disponibles han sido revisadas y aprobadas por el departamento técnico. Para productos destinados a zonas de alta salinidad consultar previamente con departamento comercial / The combinations available have been reviewed and approved by the technical department. Ask previously sales dept. for using our products in high salinity areas/ Les combinaisons disponibles ont été examinées et approuvées par le département technique. Produits destinés aux zones de haute salinité consulter à l'avance au dépt.

TABURETES

STOOLS | TABOURETS

TABURETES | STOOLS | TABOURETS

Wire patín ————— 166
Wire pie central ————— 167
Barcino ————— 168
Lisboa ————— 170

WIRE

JOSEP LLUSCÀ

Taburete
Stool
Tabouret

Estructura | Structure | Structure

- Blanco | White | Blanc
- Cromado | Chrome | Chromé

Asiento | Seat | Siège

- Negro | Black | Noir
- Blanco | White | Blanc
- Gris Verdoso | Green-grey | Gris Vert
- Rojo | Red | Rouge
- Azul Retro | Retro Bleu | Bleu Rétro



Taburete patín para uso interior. Carcasa inyectada en fibra de vidrio y PP. Estructura de acero cromado o pintado blanco. Peso neto: 7,45 kg.

Sled-base stool for indoor use. Seat injected with fiberglass and PP. Structure made of steel with chrome or white finishing. Net weight 7,45 kg. (16.42 lb)

Tabouret patin pour usage intérieur. Siège injecté en fibre de verre et PP. Structure en acier peint blanc ou chromé. Poids net 7,45kg

W 52 cm	W 20.47 in
L 54,5 cm	L 21.26 in
H 108,5 cm	H 42.52 in
Hs 74 cm	Hs 29.13 in

W: ancho / width / largeur. L: largo / length / longueur
H: altura / height / hauteur. Hs: altura asiento / seat height / hauteur du siège. Ha: altura brazo / arm height / hauteur du bras
Ø: diámetro / diameter / diamètre.

STD units	Packaging dim. (cm)	M3/ pack	NW units (kg)	Units Container 20'	Units Container 40'	Units Container HC	Units Truck 70m³	Units Truck 100m³
2	74,2x51,7x96,9	0,37	7,45	156	312	384	374	498
4	74,2x51,7x96,9	0,37	7,45	312	624	768	748	996

WIRE

JOSEP LLUSCÀ

Taburete
Stool
Tabouret

Pie | Pedestal | Pied

- Blanco | White | Blanc
 Cromado | Chrome | Chromé

Asiento | Seat | Siège

- Negro | Black | Noir
 Blanco | White | Blanc
 Gris Verdoso | Green-grey | Gris Vert
 Rojo | Red | Rouge
 Azul Retro | Retro Bleu | Bleu Rétro



Taburete pie central para uso interior. Carcasa inyectada en PP con fibra de vidrio. Estructura en acero cromado o pintado blanco. Taburete giratorio con altura regulable con pistón de gas. Peso neto 7,70kg. Hs 56-77 cm. H 94-115 cm.

Pedestal stool for indoor use. Seat injected with fiberglass and PP. Structure made of steel with chrome or white finishing. Revolving stool with adjustable height with gas piston. Net weight 7,70kg (16.98 lb) Hs 56-77 cm. H 94-115 cm.

Tabouret pied central pour usage intérieur. Siège injecté en fibre de verre et PP. Structure en acier peint blanc ou chromé. Tabouret pivotant avec manette de gaz pour régler la hauteur. Hs 56-77 cm. H 94-115 cm.

W 48cm	W 18.89 in
L 48 cm	L 18.89 in
H 115 cm	H 45.27 in
Hs 77 cm	Hs 30.31 in

W: ancho / width / largeur. L: largo / length / longueur
H: altura / height / hauteur. Hs: altura asiento / seat height / hauteur du siège. Ha: altura brazo / arm height / hauteur du bras
Ø: diámetro / diameter / diamètre.

STD units	Packaging dim. (cm)	M3/ pack	NW units (kg)	Units Container 20'	Units Container 40'	Units Container HC	Units Truck 70m ³	Units Truck 100m ³
1x	60x60x50	0,18	7,7	156	344	392	432	536

BARCINO

JOAN GASPAR

Taburete
Stool
Tabouret

 Apilable
4u. Stackable | Empilable

Personalización de colores disponible bajo pedido y sujetos a cantidades mínimas. Consulte el Departamento Comercial.

Colour customization is available upon request. Minimum orders are applicable. Contact the Sales Department.

Personnalisation de couleurs disponible sur commande. Quantités minimales à appliquer. Consultez le Département Commerciale.

- Arena | sand | sable
- Negro | Black | Noir
- Blanco | White | Blanc

 Certificados | Certificates | Certificats

Barcino stool Test Certificates:
EN 581 PUBLIC



Taburete apilable para uso interior y exterior. Estructura, asiento y respaldo de aluminio anodizado pintado por pulverización y secado al horno. Estructura de 30 x 30 mm y 2 mm de grosor. Asiento y respaldo de 4 mm de grosor. Peso neto 4,80 kg.

Stackable stool for indoor and outdoor use. Powder coated anodized aluminium structure, seat and back. Structure of 30 x 30 mm and 2 mm thick. Seat and back of 4 mm thick. Barstool net weight 4,80 kg (10,58 lb).

Tabouret empilable pour usage intérieur et extérieur. Structure, siège et dossier en aluminium anodisé peints par pulvérisation et séchés au four. Structure de 30 x 30 mm et 2 mm de grosseur. Poids net tabouret 4,80 kg.

W 36,7cm	W 14.45 in
L 39,3 cm	L 15.47 in
H 99 cm	H 38.98 in
Hs 77 cm	Hs 30.31 in

W: ancho / width / largeur. L: largo / length / longueur
H: altura / height / hauteur. Hs: altura asiento / seat height / hauteur du siège. Ha: altura brazo / arm height / hauteur du bras
Ø: diámetro / diameter / diamètre.

STD units	Packaging dim. (cm)	M3/ pack	NW units (kg)	Units Container 20'	Units Container 40'	Units Container HC	Units Truck 70m³	Units Truck 100m³
2	50x42x113	0,24	4,8	256	528	592	768	814
4	50x42x113	0,24	4,8	512	1.056	1.184	1.536	1.628



LISBOA

JOAN GASPAR

Taburete
Stool
Tabouret

- Blanco | White | Blanc
- Chocolate | Chocolate | Chocolat
- Arena | sand | sable
- Negro | Black | Noir
- Gris Oscuro | Dark Grey | Gris Foncé
- Verde Oliva | Olive Green | Vert Olive
- Rojo | Red | Rouge

 Certificados | Certificates | Certificats

Lisboa fire retardant chair Test Certificates:
EN 581-1 EN 581-2
PUBLIC
EN 16139 L1



Taburete para uso interior y exterior. Inyectada en fibra de vidrio con PP mediante tecnología de moldeo asistida por gas. Protección UV. Peso neto 4,09 kg, 3,83 kg, 2,90 kg.

Stool for indoor and outdoor use. Injected with fiberglass and PP using gas assisted injection moulding technology. UV protection. Net weight 4,09 kg. (9.01 lb), 3,83 kg. (8.44 lb), 2,90 kg. (6.39 lb).

Tabouret d'intérieur et extérieur. Injectée avec fibre de verre et PP, en utilisant technologie de moulage assistée par gaz. Protection UV. Poids net 4,09 kg, 3,83 kg, 2,90 kg.

W 42,3 cm	W 16.65 in
L 44,1 cm	L 17.36 in
H 102,2 cm	H 40.24 in
Hs 77 cm	Hs 30.31 in

W 41,6 cm	W 16.68 in
L 43,6 cm	L 17.17 in
H 92,20 cm	H 33.82 in
Hs 67 cm	Hs 26.37 in

W 40,8 cm	W 16.06 in
L 42,9 cm	L 16.89 in
H 72,9 cm	H 28.70 in
Hs 47,6 cm	Hs 18.74 in

W: ancho / width / largeur. L: largo / length / longueur. H: altura / height / hauteur. Hs: altura asiento / seat height / hauteur du siège. Ha: altura brazo / arm height / hauteur du bras Ø: diámetro / diameter / diamètre.

Artículo	STD units	Packaging dim. (cm)	M3/ pack	NW units (kg)	Units Container 20'	Units Container 40'	Units Container HC	Units Truck 70m³	Units Truck 100m³
Alto	2	60x40x94	0,22	4,09	246	520	592	632	652
Alto	4	67x43x94	0,27	4,09	352	720	720	960	1.088
Medio	2	60x40x94	0,22	3,83	246	520	592	632	652
Medio	4	60x40x94	0,22	3,83	492	1.040	1.184	1.264	1.034
Bajo	2	60x40x94	0,22	2,9	246	520	592	632	652
Bajo	4	60x40x94	0,22	2,9	492	1.040	1.184	1.264	1.304



SILLONES Y SOFÁS

ARMCHAIRS AND SOFAS | FAUTEUILS ET CANAPES

SILLONES Y SOFÁS | ARMCHAIRS

AND SOFAS | FAUTEUILS ET CANAPES

Raff sillón ————— 174

Bakú ————— 176

Click-Clack sillón ————— 178

Click-Clack sofá ————— 179

RAFF

JOAN GASPAR

Sillón
Armchair
Fauteuil

- Blanco | White | Blanc
- Arena | sand | sable
- Negro | Black | Noir
- Toscano | Tuscan | Toscane
- Burdeos | burgundy | bordeaux
- Chocolate | Chocolate | Chocolat

* Opcional | Optional | Optionnel
Cojines | Cushions | Coussins.



Sillón para uso interior y exterior. Inyectado con fibra de vidrio y PP. Protección UV. Peso neto 6,62 kg.

Armchair for indoor and outdoor use. Injected with fiberglass and PP. UV protection. Net weight 6,62 kg. (14.59 lb)

Fauteuil pour un usage intérieur et extérieur. injecté avec PP et fibre de verre. Protection UV. Poids net 6,62 kg.

Ver Set en pág. 196
See Set on pag. 196
Voir Set à la page 196

W 58,7 cm	W 23 in
L 53,5 cm	L 21 in
H 76,5 cm	H 30 in
Hs 45 cm	Hs 18 in

W: ancho / width / largeur. L: largo / length / longueur
H: altura / height / hauteur. Hs: altura asiento / seat height / hauteur du siège. Ha: altura brazo / arm height / hauteur du bras
Ø: diámetro / diameter / diamètre.

STD units	Packaging dim. (cm)	M3/ pack	NW units (kg)	Units Container 20'	Units Container 40'	Units Container HC	Units Truck 70m³	Units Truck 100m³
4	80x60x80	0,38	6,62	176	400	400	528	576



BAKÚ

JORGE PENSI

Sillón
Armchair
Fauteuil

- Blanco | White | Blanc
- Arena | sand | sable
- Negro | Black | Noir
- Azul Retro | Retro Bleu | Bleu Rétro
- Gris Verdoso | Green-grey | Gris Vert
- Chocolate | Chocolate | Chocolat



Sillón para uso interior y exterior. Inyectado en polipropileno. Apilable. Protección UV. Peso neto 7,1 kg.

Armchair for indoor and outdoor use. Injected with polypropylene. Stackable. UV Protection. Net weight 7,1 kg. (15.65 lb)

Fauteuil d'intérieur et extérieur. Injectée en polypropylène. Empilable. Protection UV. Poids net 7,1 kg.

W 67,7 cm	W 26.37 in
L 59,5 cm	L 23.42 in
H 78,5 cm	H 30.90 in
Hs 44,7 cm	Hs 17.59 in
Ha 63,5 cm	Ha 25 in

W: ancho / width / largeur. L: largo / length / longueur
H: altura / height / hauteur. Hs: altura asiento / seat height / hauteur du siège. Ha: altura brazo / arm height / hauteur du bras
Ø: diámetro / diameter / diamètre.

STD units	Packaging dim. (cm)	M3/ pack	NW units (kg)	Units Container 20'	Units Container 40'	Units Container HC	Units Truck 70m ³	Units Truck 100m ³
2	73,7x60,7x96,9	0,43	7,1	124	264	-	356	450
4	80x61x110	0,54	7,1	206	460	-	624	696
26	120x80x220	2,11	7,1	286	650	-	858	936



CLICK-CLACK

JOSEP LLUSCÀ

Sillón
Armchair
Fauteuil

- Blanco | White | Blanc
- Arena | sand | sable
- Chocolate | Chocolate | Chocolat

 Certificados | Certificates | Certificats

Click-clack armchair Test Certificates:
EN 581 PUBLIC



Sillón para uso interior y exterior. Inyectado en PP mediante tecnología de moldeo asistida por gas. Protección contra rayos UV. Se entrega desmontado en un óptimo packaging. Cojines opcionales. Peso neto 10,5 kg.

Armchair for indoor and outdoor use. Injected in PP using gas assisted injection moulding technology. UV Protection. Delivered unassembled in an optimal packaging. Optional cushions. Net weight 10,5 kg (23,15 lb).

Fauteuil d'intérieur et extérieur. Injecté en PP, en utilisant technologie de moulage assistée par gaz. Protection UV. Livré démonté dans un packaging optimal. Coussins optionnels. Poids net 10,5 kg.

W 74 cm	W 29.13 in
L 64,5 cm	L 25.39 in
H 72,5 cm	H 28.54 in
Hs 42 cm	Hs 16.54 in

W: ancho / width / largeur. L: largo / length / longueur
H: altura / height / hauteur. Hs: altura asiento / seat height / hauteur du siège. Ha: altura brazo / arm height / hauteur du bras
Ø: diámetro / diameter / diamètre.

STD units	Packaging dim. (cm)	M3/ pack	NW units (kg)	Units Container 20'	Units Container 40'	Units Container HC	Units Truck 70m³	Units Truck 100m³
1	40x80x74	0,24	10,5	99	225	225	297	360

CLICK-CLACK

JOSEP LLUSCÀ

Sofa
Sofa
Canapé

- Blanco | White | Blanc
- Arena | sand | sable
- Chocolate | Chocolate | Chocolat

 Certificados | Certificates | Certificats

Click-clack sofa Test Certificates:
EN 581 PUBLIC



Sofá para uso interior y exterior. Inyectado en PP mediante tecnología de moldeo asistida por gas. Protección contra rayos UV. Se entrega desmontado en un óptimo packaging. Cojines opcionales. Peso neto 15 kg.

Sofa for indoor and outdoor use. Injected in PP using gas assisted injection moulding technology. UV Protection. Delivered unassembled in an optimal packaging. Optional cushions. Net weight 15 kg (33.07 lb).

Canapé d'intérieur et extérieur. Injecté en PP, en utilisant technologie de moulage assistée par gaz. Protection UV. Livré démonté dans un packaging optimal. Coussins optionnels. Poids net 15 kg.

W 124 cm	W 48.82 in
L 64,5 cm	L 25.39 in
H 72,5 cm	H 28.54 in
Hs 42 cm	Hs 16.54 in

W: ancho / width / largeur. L: largo / length / longueur
H: altura / height / hauteur. Hs: altura asiento / seat height / hauteur du siège. Ha: altura brazo / arm height / hauteur du bras
Ø: diámetro / diameter / diamètre.

STD units	Packaging dim. (cm)	M3/ pack	NW units (kg)	Units Container 20'	Units Container 40'	Units Container HC	Units Truck 70m³	Units Truck 100m³
1	40x115x74	0,34	15	66	150	150	198	240

INFANTIL

KIDS | ENFANTS

INFANTIL | KIDS | ENFANTS

Jan silla	182
Jan mesa	183
Rita silla	186
Rita mesa	187
Julieta silla	190
Julieta mesa	191

JAN

DAVID CARRASCO BARCELÓ

Silla
Chair
Chaise

- 1 JAN FROG
- 2 JAN CAT
- 3 JAN

Apilable
10u. Stackable | Empilable

NEW

- Fucsia | Fuchsia | Fuchsia
- Aquamint | Aquamint | Aquamint
- Naranja | Orange | Orange
- Verde Lima | Lime Green | Vert Lime
- Azul Cielo | Light Blue | Bleu Ciel



Certificados | Certificates | Certificats

Jan Test Certificates:
UNE 1729-1



Silla inyectada en polipropileno. Peso neto 1,43 kg. Box palet surtido de colores (20 unidades): 4 verde lima / 4 azul cielo / 4 fucsia / 4 naranja / 4 aquamint. Tres modelos disponibles: JAN, JAN FROG y JAN CAT.

Chair injected in polypropylene. Net weight 1,43 kg (3,15 lb). Box pallet (20 units): 4 lime green / 4 light blue / 4 fuchsia / 4 orange / 4 aquamint. Three models available: JAN, JAN FROG and JAN CAT.

Chaise injectée en polypropylène. Poids net 1,43 kg. Box palette (20 unités): 4 vert lime / 4 bleu ciel / 4 fuchsia / 4 orange / 4 aquamint. Trois modèles disponibles: JAN, JAN FROG et JAN CAT.



W 38,60 cm	W 15.20 in
L 38 cm	L 14.96 in
H 59,50 cm	H 23.42 in
Hs 31 cm	Hs 12.20 in

W: ancho / width / largeur. L: largo / length / longueur
H: altura / height / hauteur. Hs: altura asiento / seat height / hauteur du siège. Ha: altura brazo / arm height / hauteur du bras
Ø: diámetro / diameter / diamètre.

STD units	Packaging dim. (cm)	M3/ pack	NW units (kg)	Units Container 20'	Units Container 40'	Units Container HC	Units Truck 70m³	Units Truck 100m³
4	80x40x45	0,14	1,43	700	1.500	1.800	2.228	2.688
20	80x60x120	0,58	1,43	-	-	2.200	2.680	3.200

JAN

DAVID CARRASCO BARCELÓ

Mesa
Table
Table

 Apilable
Stackable | Empilable

NEW

- Fucsia | Fuchsia | Fuchsia
- Aquamint | Aquamint | Aquamint
- Naranja | Orange | Orange
- Verde Lima | Lime Green | Vert Lime
- Azul Cielo | Light Blue | Bleu Ciel



 Certificados | Certificates | Certificats

Jan Table Test Certificates:
UNE 1729-1



Mesa monobloc inyectada en polipropileno con portarotuladores con tapa extraíble. Superficie para dibujar con rotuladores borrables. Peso neto 2,73 kg. Box pallet (10 unidades): 2 verde lima / 2 azul cielo / 2 fucsia / 2 naranja / 2 aquamint

Table monoblock injected in polypropylene with pen tray with removable lid. Surface for drawing with erasable markers. Net weight 2,73 kg (6.01 lb). Box pallet (10 units): 2 lime green / 2 light blue / 2 fuchsia / 2 orange / 2 aquamint.

Table monobloc injectée en polypropylène avec portemarqueurs et couvercle amovible. Surface pour dessiner avec marqueurs non permanents. Poids net 2,73 kg. Box palette (10 unités): 2 vert lime / 2 bleu ciel / 2 fuchsia / 2 orange / 2 aquamint.



W 69,70 cm | W 27.44 in
L 59,70 cm | L 23.50 in
H 45 cm | H 17.72 in

W: ancho / width / largeur. L: largo / length / longueur
H: altura / height / hauteur. Hs: altura asiento / seat height / hauteur du siège. Ha: altura brazo / arm height / hauteur du bras
Ø: diámetro / diameter / diamètre.

STD units	Packaging dim. (cm)	M3/ pack	NW units (kg)	Units Container 20'	Units Container 40'	Units Container HC	Units Truck 70m³	Units Truck 100m³
4	80x60x80	0,38	2,73	264	580	700	840	1.000
10	80x60x120	0,58	2,73	-	-	1.100	1.340	1.600





RITA

JOAN GASPAR

Sillón
Armchair
Fauteuil

Apilable
20u. Stackable | Empilable

- Rojo | Red | Rouge
- Naranja | Orange | Orange
- Verde Lima | Lime Green | CitronVert
- Azul Cielo | Light Blue | Bleu Cel
- Rosa | Pink | Rose



Certificados | Certificates | Certificats

Rita chair Test Certificates:
D60-300

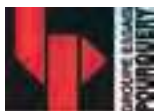

Sillón infantil para uso interior y exterior. Inyectado en polipropileno. Apilable. Protección UV. Peso neto 1,31 kg. Box palet 66 unidades: 22 verde lima / 11 azul cielo / 11 rosa / 11 naranja / 11 roja.

Child armchair for indoor and outdoor use. Injected with polypropylene. Stackable. UV protection. Net weight 1,31 kg. (2.89 lb). Box pallet 66 units: 22 lime green / 11 light blue / 11 pink / 11 orange / 11 red.

Fauteuil pour enfant d'intérieur et extérieur. Injectée en polypropylène. Empilable. Protection UV. Poids net 1,31 kg. Box palette 66 unités: 22 vert lime / 11 bleu ciel / 11 rose / 11 orange / 11 rouge.

W 38 cm	W 14.96 in
L 37 cm	L 14.57 in
H 59,7 cm	H 23.50 in
Hs 31,4cm	Hs 12.36 in

W: ancho / width / largeur. L: largo / length / longueur
H: altura / height / hauteur. Hs: altura asiento / seat height / hauteur du siège. Ha: altura brazo / arm height / hauteur du bras
Ø: diámetro / diameter / diamètre.

STD units	Packaging dim. (cm)	M3/ pack	NW units (kg)	Units Container 20'	Units Container 40'	Units Container HC	Units Truck 70m³	Units Truck 100m³
4	39,5x41x78	0,13	1,31	952	1.980	2.160	2.440	2.920
216	120x80x220	2,11	1,31	2.370	5.400	5.400	7.128	8.640
66	120x80x120	1,15	1,31	-	-	3.300	4.356	5.280

RITA

JOAN GASPAR

Mesa
Table
Table

 Apilable
20u. Stackable | Empilable

- Rojo | Red | Rouge
- Naranja | Orange | Orange
- Verde Lima | Lime Green | CitronVert
- Azul Cielo | Light Blue | Bleu Cel
- Rosa | Pink | Rose



Certificados | Certificates | Certificats

Rita table Test Certificates:
D60-300



Mesa monobloc para uso interior y exterior. Inyectada en polipropileno. Apilable. Protección UV. Peso neto 1,85 kg. Box palet (15 unidades): 3 verde lima / 3 azul cielo / 3 rosa / 3 naranja / 3 roja.

Monobloc table for indoor and outdoor use. Injected with polypropylene. Stackable. Uv protection. Net weight 1,85 kg (4.08 lb). Box pallet (15 units): 3 lime green / 3 light blue / 3 pink / 3 orange / 3 red.

Table monobloc d'intérieur et extérieur. Injectée en polypropylène. Empilable. Protection UV. Poids net 1,85 kg. Box palette (15 unités): 3 vert lime / 3 bleu ciel / 3 rose / 3 orange / 3 rouge.

W 57 cm | W 22.44 in
L 53 cm | L 20.86 in
H 49 cm | H 19.29 in

W: ancho / width / largeur. L: largo / length / longueur
H: altura / height / hauteur. Hs: altura asiento / seat height / hauteur du siège. Ha: altura brazo / arm height / hauteur du bras
Ø: diámetro / diameter / diamètre.

STD units	Packaging dim. (cm)	M3/ pack	NW units (kg)	Units Container 20'	Units Container 40'	Units Container HC	Units Truck 70m ³	Units Truck 100m ³
4	61x61x62	0,23	1,82	324	684	912	1.064	1.240
80	120x60x213	2,04	1,82	880	2.000	2.000	2.640	2.880
15	80x60x120	0,58	1,82	-	-	1.650	2.010	2.400





JULIETA

JOAN GASPAR

Silla
Chair
Chaise

Apilable
20u. Stackable | Empilable

- Rojo | Red | Rouge
- Naranja | Orange | Orange
- Verde Lima | Lime Green | CitronVert
- Rosa | Pink | Rose
- Azul Cielo | Light Blue | Bleu Cel



Certificados | Certificates | Certificats

Julieta chair Test Certificates:
D60-300



Silla infantil para uso interior y exterior. Inyectada en polipropileno. Apilable. Protección UV. Peso neto 1,18 kg. Box palet (60 unidades): 20 verde lima / 10 azul cielo / 10 rosa / 10 naranja / 10 roja.

Child chair for indoor and outdoor use. Injected with polypropylene. Stackable. UV Protection. Net weight 1,18 kg. (2.60 lb). Box pallet (60 units): 20 lime green / 10 light blue / 10 pink / 10 orange / 10 red.

Chaise pour enfant d'intérieur et extérieur. Injectée en polypropylène. Empilable. Protection UV. Poids net 1,18 kg. Box palette (60 unités): 20 vert lime / 10 bleu ciel / 10 rose / 10 orange / 10 rouge.

W 37,5 cm	W 14.76 in
L 40 cm	L 15.75 in
H 58 cm	H 22.83 in
Hs 31,6cm	Hs 12.44 in

W: ancho / width / largeur. L: largo / length / longueur
H: altura / height / hauteur. Hs: altura asiento / seat height / hauteur du siège. Ha: altura brazo / arm height / hauteur du bras
Ø: diámetro / diameter / diamètre.

STD units	Packaging dim. (cm)	M3/ pack	NW units (kg)	Units Container 20'	Units Container 40'	Units Container HC	Units Truck 70m³	Units Truck 100m³
4	39,5x41x78	0,13	1,18	952	1.980	2.160	2.440	2.920
192	120x80x222	2,13	1,18	2.112	4.800	4.800	6.336	7.680
60	120x80x120	1,15	1,18	-	-	3.000	3.960	4.800

JULIETA

JOAN GASPAR

Mesa
Table
Table

 Apilable
20u. Stackable | Empilable

- Rojo | Red | Rouge
- Naranja | Orange | Orange
- Verde Lima | Lime Green | CitronVert
- Rosa | Pink | Rose
- Azul Cielo | Light Blue | Bleu Cel



 Certificados | Certificates | Certificats

Julieta table Test Certificates:
D60-300



Mesa monobloc para uso interior y exterior. Inyectada en polipropileno. Apilable. Protección UV. Peso neto 1,70 kg. Box palet (15 unidades): 3 verde lima / 3 azul cielo / 3 rosa / 3 naranja / 3 roja.

Monobloc table for indoor and outdoor use. Injected with polypropylene. Stackable. UV Protection. Net weight 1,70 kg (3.75 lb). Box pallet (15 units): 3 lime green / 3 light blue / 3 pink / 3 orange / 3 red.

Table monobloc d'intérieur et extérieur. Injectée en polypropylène. Empilable. Protection UV. Poids net 1,70 kg. Box palette (15 unités): 3 vert lime / 3 bleu ciel / 3 rose / 3 orange / 3 rouge.

W 50 cm | W 19.69 in
L 50 cm | L 19.69 in
H 49 cm | H 19.29 in

W: ancho / width / largeur. L: largo / length / longueur
H: altura / height / hauteur. Hs: altura asiento / seat height / hauteur du siège. Ha: altura brazo / arm height / hauteur du bras
Ø: diámetro / diameter / diamètre.

STD units	Packaging dim. (cm)	M3/ pack	NW units (kg)	Units Container 20'	Units Container 40'	Units Container HC	Units Truck 70m ³	Units Truck 100m ³
4	61x61x62	0,23	1,7	324	684	912	1.064	1.240
80	120x60x213	1,53	1,7	880	2.000	2.000	2.640	2.880
15	80x60x120	0,58	1,7	-	-	1.650	2.010	2.400





SETS

SETS

Raff	196
Click-Clack	197





RAFF SET

JOAN GASPAR

Set



- Blanco | White | Blanc
- Arena | sand | sable
- Toscano | Tuscan | Toscane
- Burdeos | Burgundy | Bordeaux
- Chocolate | Chocolate | Chocolat
- Negro | Black | Noir



Set para uso interior y exterior compuesto por 2 sillones y una mesa. Inyectado con fibra de vidrio y PP. Protección UV. Peso neto 16 kg. El set está disponible en dos versiones, con cojines o sin cojines. Óptimo packaging.

Set for indoor and outdoor use composed of two armchairs and one table. Injected with fiberglass and PP. UV protection. Net weight 16 kg. (35.27 lb) The set is available in two versions, with cushions or without cushions. Optimal packaging.

Set pour usage intérieur et extérieur composé par 2 fauteuils et 1 table. Injecté avec PP et fibre de verre. Protection UV. Poids net 16 kg. Le set est disponible en deux versions, avec coussins ou sans coussins. Packaging optimal.

∅ 40 cm	∅ 16 in
H 37,1 cm	H 14 in
W 58,7 cm	W 23 in
L 53,5 cm	L W 21 in
H 76,5 cm	H 30 in
Hs 45 cm	Hs 18 in



W: ancho / width / largeur. L: largo / length / longueur H: altura / height / hauteur. Hs: altura asiento / seat height / hauteur du siège. Ha: altura brazo / arm height / hauteur du bras ∅: diámetro / diameter / diamètre.

STD units	Packaging dim. (cm)	M3/ pack	NW units (kg)	Units Container 20'	Units Container 40'	Units Container HC	Units Truck 70m³	Units Truck 100m³
1	60x63x60	0,23	16	81	180	240	347	416

CLICK-CLACK

JOSEP LLUSCÀ

Set

- Blanco | White | Blanc
- Arena | sand | sable
- Chocolate | Chocolate | Chocolat



Certificados | Certificates | Certificats

Click-clack armchair Test Certificates:
EN 581 PUBLIC



Set de polipropileno inyectado para uso interior y exterior compuesto por 1 sofá doble, 2 sillones, 1 mesa y 3 cojines. Óptimo packaging.

Set of injected polypropilene for indoor and outdoor use composed of 1 double sofa, 2 armchairs, 1 table and 3 cushions. Optimal packaging.

Set injectée en polypropylène pour usage intérieur et extérieur composé par 1 double canapé, 2 fauteuils, 1 table et 3 coussins. Packaging optimal.

W 45 cm | W 17.72 in
L 90cm | L 35.43 in
H 45 cm | H 17.72 in

W 124 cm | W 48.82 in
L 64,5 cm | L 25.39 in
H 72,5 cm | H 28.54 in
Hs 42 cm | Hs 16.54 in

W 74 cm | W 29.13 in
L 64,5 cm | L 25.39 in
H 72,5 cm | H 28.54 in
Hs 42 cm | Hs 16.54 in



W: ancho / width / largeur. L: largo / length / longueur
H: altura / height / hauteur. Hs: altura asiento / seat height / hauteur du siège. Ha: altura brazo / arm height / hauteur du bras
Ø: diámetro / diameter / diamètre.

STD units	Packaging dim. (cm)	M3/pack	NW units (kg)	Units Container 20'	Units Container 40'	Units Container HC	Units Truck 70m³	Units Truck 100m³
1	120x80x53	0,5	45	51	110	135	155	200





Set Click-Clack (p. 197)

TUMBONA Y MESA AUXILIAR

SUN LOUNGER AND SIDE TABLE |
BAIN DE SOLEIL ET TABLE AUXILIAIRE

**TUMBONA Y MESA
AUXILIAR |**

SUN LOUNGER AND SIDE TABLE |

BAIN DE SOLEIL ET TABLE AUXILIAIRE

Sky ————— 202

Ocean ————— 205

SKY

JOSEP LLUSCÀ

Tumbona
Sun lounger
Chaise longue

Apilable
Stackable | Empilable

Estructura | Structure | Structure

- Wengé | Wenge | Wenge
- Blanco | White | Blanc
- Chocolate | Chocolate | Chocolat
- Gris Oscuro | Dark Grey | Gris Foncé
- Arena | Sand | Sable



Certificados | Certificates | Certificats

Sky Test Certificates:
EN 581 PUBLIC



Tumbona apilable para uso interior y exterior. Estructura de polipropileno reforzado con fibra de vidrio. Reclinable en 5 posiciones, incluyendo posición extraplana ideal para estar tumbado boca abajo. Respaldo con tope de seguridad. Ruedas en patas traseras y tacos antideslizantes en las delanteras y traseras. Peso neto 13,7 kg.

Stackable sunlounger for indoor and outdoor use. Structure in polypropylene reinforced with fiber glass, designed with forms that are pure, soft, round and natural, and yet robust. Five-position reclining sunlounger, including flat position. Back with safety stopper. Wheels under back legs and non-slip endplates under front and back legs. Net weight 13,7 kg (30.20 lb).

Chaise longue empilable pour usage intérieur et extérieur. Structure en Polypropylène et renforcée avec de la fibre de verre. Cinq positions du dossier, inclus position extraplate. Dossier avec arrêt de sécurité. Pieds arrière munis de roues et pieds avant et arrière munis de patins antidérapants. Poids net 13,7 kg.

W 77 cm | W 30.31 in
L 195 cm | L 76.77 in
H 37 cm | H 14.57 in

W: ancho / width / largeur. L: largo / length / longueur
H: altura / height / hauteur. Hs: altura asiento / seat height / hauteur du siège. Ha: altura brazo / arm height / hauteur du bras
Ø: diámetro / diameter / diamètre.

STD units	Packaging dim. (cm)	M3/ pack	NW units (kg)	Units Container 20'	Units Container 40'	Units Container HC	Units Truck 70m³	Units Truck 100m³
20	196x77.5x220	3,34	13,70	180	360	360	440	480

El tejido es un material con cierta elasticidad, transpirable y ha estado diseñado para poder ser fácilmente intercambiable. Tela 850 gr/m² y 500gr/m² (Ferrari) diseñada con formas puras redondas y naturales, termosoldado para mayor resistencia.

Fabric is a material with the right degree of elasticity, that transpires and has been designed to be replaced with very little effort. Textilene 850 gr/m² and 500gr/m² (Ferrari) round shapes designed with pure and natural, heat-welded to improve resistance.

Le tissu est d'un matériel d'une certaine élasticité, transpirable et a été conçu pour pouvoir être facilement interchangeable. Toile 850 gr/m² y 500gr/m² (Ferrari) conçue avec des formes pures rondes et naturelles, thermo-soudée pour une plus grande résistance.

- Tejido: 850,95 gr/m² - 500gr/m
 - Termo soldada para evitar roturas y transpirable
 - Protección UV
 - Normativa ASTM (Resistente al peso e impacto)
 - ISO 9001
 - ISO 14001
- Fabric: 850,95 gr/m² - 500gr/m²
 - Heat-sealing to prevent breakage and breathable
 - UV protection
 - ASTM Standards (Weight and impact resistant)
 - ISO 9001
 - ISO 14001
- Tissus: 850,95 gr/m² - 500gr/m²
 - Thermo—soudée pour éviter les déchirures et transpirable
 - UV protection
 - Norme ASTM (résistant au poids et impact)
 - ISO 9001
 - ISO 14001

PREMIUM 500 gr/m² (Batyline)

<table border="0" style="width: 100%;"> <tr><td style="width: 20px; height: 10px; background-color: #003366;"></td><td>Azul Blue Bleu</td></tr> <tr><td style="width: 20px; height: 10px; background-color: #ffffff;"></td><td>Blanco White Blanc</td></tr> <tr><td style="width: 20px; height: 10px; background-color: #ffcc00;"></td><td>Amarillo Yellow Jaune</td></tr> <tr><td style="width: 20px; height: 10px; background-color: #ffffff;"></td><td>Blanco White Blanc</td></tr> <tr><td style="width: 20px; height: 10px; background-color: #333333;"></td><td>Chocolate Chocolate Chocolat</td></tr> <tr><td style="width: 20px; height: 10px; background-color: #ffffff;"></td><td>Blanco White Blanc</td></tr> <tr><td style="width: 20px; height: 10px; background-color: #cccccc;"></td><td>Crudo Natural Ecreu</td></tr> <tr><td style="width: 20px; height: 10px; background-color: #ffffff;"></td><td>Blanco White Blanc</td></tr> <tr><td style="width: 20px; height: 10px; background-color: #003366;"></td><td>Azul Blue Bleu</td></tr> <tr><td style="width: 20px; height: 10px; background-color: #333333;"></td><td>Wengé Wenge Wenge</td></tr> <tr><td style="width: 20px; height: 10px; background-color: #ffcc00;"></td><td>Amarillo Yellow Jaune</td></tr> <tr><td style="width: 20px; height: 10px; background-color: #333333;"></td><td>Wengé Wenge Wenge</td></tr> <tr><td style="width: 20px; height: 10px; background-color: #cccccc;"></td><td>Crudo Natural Ecreu</td></tr> <tr><td style="width: 20px; height: 10px; background-color: #333333;"></td><td>Wengé Wenge Wenge</td></tr> <tr><td style="width: 20px; height: 10px; background-color: #333333;"></td><td>Chocolate Chocolate Chocolat</td></tr> <tr><td style="width: 20px; height: 10px; background-color: #333333;"></td><td>Wengé Wenge Wenge</td></tr> </table>		Azul Blue Bleu		Blanco White Blanc		Amarillo Yellow Jaune		Blanco White Blanc		Chocolate Chocolate Chocolat		Blanco White Blanc		Crudo Natural Ecreu		Blanco White Blanc		Azul Blue Bleu		Wengé Wenge Wenge		Amarillo Yellow Jaune		Wengé Wenge Wenge		Crudo Natural Ecreu		Wengé Wenge Wenge		Chocolate Chocolate Chocolat		Wengé Wenge Wenge	<table border="0" style="width: 100%;"> <tr><td style="width: 20px; height: 10px; background-color: #ffcc00;"></td><td>Amarillo Yellow Jaune</td></tr> <tr><td style="width: 20px; height: 10px; background-color: #333333;"></td><td>Chocolate Chocolate Chocolat</td></tr> <tr><td style="width: 20px; height: 10px; background-color: #333333;"></td><td>Chocolate Chocolate Chocolat</td></tr> <tr><td style="width: 20px; height: 10px; background-color: #333333;"></td><td>Chocolate Chocolate Chocolat</td></tr> <tr><td style="width: 20px; height: 10px; background-color: #cccccc;"></td><td>Crudo Natural Ecreu</td></tr> <tr><td style="width: 20px; height: 10px; background-color: #333333;"></td><td>Chocolate Chocolate Chocolat</td></tr> <tr><td style="width: 20px; height: 10px; background-color: #ffcc00;"></td><td>Amarillo Yellow Jaune</td></tr> <tr><td style="width: 20px; height: 10px; background-color: #333333;"></td><td>Gris Oscuro Dark Grey Gris Foncé</td></tr> <tr><td style="width: 20px; height: 10px; background-color: #cccccc;"></td><td>Crudo Natural Ecreu</td></tr> <tr><td style="width: 20px; height: 10px; background-color: #333333;"></td><td>Gris Oscuro Dark Grey Gris Foncé</td></tr> <tr><td style="width: 20px; height: 10px; background-color: #ffcc00;"></td><td>Amarillo Yellow Jaune</td></tr> <tr><td style="width: 20px; height: 10px; background-color: #cccccc;"></td><td>Arena Sand Sable</td></tr> <tr><td style="width: 20px; height: 10px; background-color: #333333;"></td><td>Chocolate Chocolate Chocolat</td></tr> <tr><td style="width: 20px; height: 10px; background-color: #cccccc;"></td><td>Arena Sand Sable</td></tr> <tr><td style="width: 20px; height: 10px; background-color: #cccccc;"></td><td>Crudo Natural Ecreu</td></tr> <tr><td style="width: 20px; height: 10px; background-color: #cccccc;"></td><td>Arena Sand Sable</td></tr> </table>		Amarillo Yellow Jaune		Chocolate Chocolate Chocolat		Chocolate Chocolate Chocolat		Chocolate Chocolate Chocolat		Crudo Natural Ecreu		Chocolate Chocolate Chocolat		Amarillo Yellow Jaune		Gris Oscuro Dark Grey Gris Foncé		Crudo Natural Ecreu		Gris Oscuro Dark Grey Gris Foncé		Amarillo Yellow Jaune		Arena Sand Sable		Chocolate Chocolate Chocolat		Arena Sand Sable		Crudo Natural Ecreu		Arena Sand Sable	<table border="0" style="width: 100%;"> <tr><td style="width: 20px; height: 10px; border: 1px solid black;"></td><td>Tejido fabric tissu</td></tr> <tr><td style="width: 20px; height: 10px; border: 1px solid black;"></td><td>Estructura structure structure</td></tr> </table> <div style="text-align: center; margin-top: 10px;">  </div>		Tejido fabric tissu		Estructura structure structure
	Azul Blue Bleu																																																																					
	Blanco White Blanc																																																																					
	Amarillo Yellow Jaune																																																																					
	Blanco White Blanc																																																																					
	Chocolate Chocolate Chocolat																																																																					
	Blanco White Blanc																																																																					
	Crudo Natural Ecreu																																																																					
	Blanco White Blanc																																																																					
	Azul Blue Bleu																																																																					
	Wengé Wenge Wenge																																																																					
	Amarillo Yellow Jaune																																																																					
	Wengé Wenge Wenge																																																																					
	Crudo Natural Ecreu																																																																					
	Wengé Wenge Wenge																																																																					
	Chocolate Chocolate Chocolat																																																																					
	Wengé Wenge Wenge																																																																					
	Amarillo Yellow Jaune																																																																					
	Chocolate Chocolate Chocolat																																																																					
	Chocolate Chocolate Chocolat																																																																					
	Chocolate Chocolate Chocolat																																																																					
	Crudo Natural Ecreu																																																																					
	Chocolate Chocolate Chocolat																																																																					
	Amarillo Yellow Jaune																																																																					
	Gris Oscuro Dark Grey Gris Foncé																																																																					
	Crudo Natural Ecreu																																																																					
	Gris Oscuro Dark Grey Gris Foncé																																																																					
	Amarillo Yellow Jaune																																																																					
	Arena Sand Sable																																																																					
	Chocolate Chocolate Chocolat																																																																					
	Arena Sand Sable																																																																					
	Crudo Natural Ecreu																																																																					
	Arena Sand Sable																																																																					
	Tejido fabric tissu																																																																					
	Estructura structure structure																																																																					

CLUB 850 gr/m²

<table border="0" style="width: 100%;"> <tr><td style="width: 20px; height: 10px; background-color: #333333;"></td><td>Gris-Negro Grey-Black Gris-Noir</td></tr> <tr><td style="width: 20px; height: 10px; background-color: #ffffff;"></td><td>Blanco White Blanc</td></tr> <tr><td style="width: 20px; height: 10px; background-color: #ffffff;"></td><td>Blanco White Blanc</td></tr> <tr><td style="width: 20px; height: 10px; background-color: #ffffff;"></td><td>Blanco White Blanc</td></tr> <tr><td style="width: 20px; height: 10px; background-color: #003366;"></td><td>Azul Blue Bleu</td></tr> <tr><td style="width: 20px; height: 10px; background-color: #ffffff;"></td><td>Blanca White Blanc</td></tr> <tr><td style="width: 20px; height: 10px; background-color: #333333;"></td><td>Beige Beige Beige</td></tr> <tr><td style="width: 20px; height: 10px; background-color: #333333;"></td><td>Wengé Wenge Wenge</td></tr> <tr><td style="width: 20px; height: 10px; background-color: #333333;"></td><td>Chocolate Chocolate Chocolat</td></tr> <tr><td style="width: 20px; height: 10px; background-color: #333333;"></td><td>Chocolate Chocolate Chocolat</td></tr> </table>		Gris-Negro Grey-Black Gris-Noir		Blanco White Blanc		Blanco White Blanc		Blanco White Blanc		Azul Blue Bleu		Blanca White Blanc		Beige Beige Beige		Wengé Wenge Wenge		Chocolate Chocolate Chocolat		Chocolate Chocolate Chocolat	<table border="0" style="width: 100%;"> <tr><td style="width: 20px; height: 10px; background-color: #cccccc;"></td><td>Beige Beige Beige</td></tr> <tr><td style="width: 20px; height: 10px; background-color: #333333;"></td><td>Chocolate Chocolate Chocolat</td></tr> <tr><td style="width: 20px; height: 10px; background-color: #ffffff;"></td><td>Blanco White Blanc</td></tr> <tr><td style="width: 20px; height: 10px; background-color: #333333;"></td><td>Chocolate Chocolate Chocolat</td></tr> <tr><td style="width: 20px; height: 10px; background-color: #cccccc;"></td><td>Beige Beige Beige</td></tr> <tr><td style="width: 20px; height: 10px; background-color: #333333;"></td><td>Gris Oscuro Dark Grey Gris Foncé</td></tr> <tr><td style="width: 20px; height: 10px; background-color: #333333;"></td><td>Gris Negro Grey-Black Gris Noir</td></tr> <tr><td style="width: 20px; height: 10px; background-color: #333333;"></td><td>Gris Oscuro Dark Grey Gris Foncé</td></tr> <tr><td style="width: 20px; height: 10px; background-color: #ffffff;"></td><td>Blanco White Blanc</td></tr> <tr><td style="width: 20px; height: 10px; background-color: #333333;"></td><td>Gris Oscuro Dark Grey Gris Foncé</td></tr> </table>		Beige Beige Beige		Chocolate Chocolate Chocolat		Blanco White Blanc		Chocolate Chocolate Chocolat		Beige Beige Beige		Gris Oscuro Dark Grey Gris Foncé		Gris Negro Grey-Black Gris Noir		Gris Oscuro Dark Grey Gris Foncé		Blanco White Blanc		Gris Oscuro Dark Grey Gris Foncé	<table border="0" style="width: 100%;"> <tr><td style="width: 20px; height: 10px; background-color: #ffcc00;"></td><td>Amarillo Yellow Jaune</td></tr> <tr><td style="width: 20px; height: 10px; background-color: #cccccc;"></td><td>Arena Sand Sable</td></tr> <tr><td style="width: 20px; height: 10px; background-color: #333333;"></td><td>Chocolate Chocolate Chocolat</td></tr> <tr><td style="width: 20px; height: 10px; background-color: #cccccc;"></td><td>Arena Sand Sable</td></tr> <tr><td style="width: 20px; height: 10px; background-color: #ffffff;"></td><td>Blanco White Blanc</td></tr> <tr><td style="width: 20px; height: 10px; background-color: #cccccc;"></td><td>Arena Sand Sable</td></tr> </table>		Amarillo Yellow Jaune		Arena Sand Sable		Chocolate Chocolate Chocolat		Arena Sand Sable		Blanco White Blanc		Arena Sand Sable
	Gris-Negro Grey-Black Gris-Noir																																																					
	Blanco White Blanc																																																					
	Blanco White Blanc																																																					
	Blanco White Blanc																																																					
	Azul Blue Bleu																																																					
	Blanca White Blanc																																																					
	Beige Beige Beige																																																					
	Wengé Wenge Wenge																																																					
	Chocolate Chocolate Chocolat																																																					
	Chocolate Chocolate Chocolat																																																					
	Beige Beige Beige																																																					
	Chocolate Chocolate Chocolat																																																					
	Blanco White Blanc																																																					
	Chocolate Chocolate Chocolat																																																					
	Beige Beige Beige																																																					
	Gris Oscuro Dark Grey Gris Foncé																																																					
	Gris Negro Grey-Black Gris Noir																																																					
	Gris Oscuro Dark Grey Gris Foncé																																																					
	Blanco White Blanc																																																					
	Gris Oscuro Dark Grey Gris Foncé																																																					
	Amarillo Yellow Jaune																																																					
	Arena Sand Sable																																																					
	Chocolate Chocolate Chocolat																																																					
	Arena Sand Sable																																																					
	Blanco White Blanc																																																					
	Arena Sand Sable																																																					



Posicionador de fácil colocación mediante el propio peso. 5 posiciones.

Easy backrest regulation system by own weight. Five-position reclining sunlounger.

Positionneur avec réglage facile par son propre poids. 5 positions du dossier.

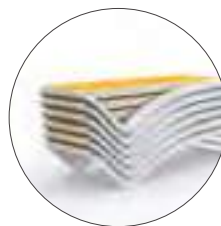

Máxima apilabilidad en el mínimo espacio.

Maximum stackability in minimum space.

Empilable au maximum dans un espace minimum.

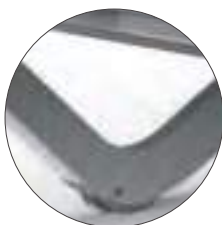

Ruedas en patas traseras.

Wheels under back legs.

Pleds arrière avec roulettes.



Acabado antideslizante en las patas.

Non-slip end-plates under legs.

Patins antidérapant.



OCEAN

Mesa auxiliar | Side table | Table auxiliaire



- Blanco | White | Blanc
- Negro | Black | Noir
- Arena/Arena | Sand/Sand | Sable/Sable
- Chocolate | Chocolate | Chocolat

Siesta
exclusive

La mesa auxiliar Ocean está fabricada en polipropileno resistente a la intemperie. Con protección UV, lo que asegura que sus colores permanecieran intactos. Se puede desmontar. Para uso interior y exterior.

Ocean Side Table is made of durable weather-resistant polypropylene. It is UV protected which insures the colors will not fade. Can be disassembled. For indoor and outdoor use.

La table d'appoint Ocean est fabriquée en polypropylène résistant aux intempéries. Dotée d'une protection UVA, ce qui permet d'éviter l'usure des couleurs. Elle est démontable. Pour un usage intérieur et extérieur.

W 45 cm	W 17.72 in
L 45 cm	L 17.72 in
H 45 cm	H 17.72 in

W: ancho / width / largeur. **L:** largo / length / longueur
H: altura / height / hauteur. **Hs:** altura asiento / seat height /
 hauteur du siège. **Ha:** altura brazo / arm height / hauteur du bras
Ø: diámetro / diameter / diamètre.

STD units	Packaging dim. (cm)	M3/pack	NW units (kg)	Units Container 20'	Units Container 40'	Units Container HC	Units Truck 70m³	Units Truck 100m³
1	46x48x12	0,026	2,8	1140	-	2.550	-	3.300

CONTRACT

RESOL CONTRACT ofrece una amplia gama de productos diseñados y desarrollados para asegurar el alto rendimiento requerido por el sector profesional. Con múltiples acabados, colores, combinaciones y materiales, el mobiliario RESOL CONTRACT se adapta a su medida para que pueda encontrar el producto que necesita en cada momento.

RESOL CONTRACT offers a wide range of products designed and developed to ensure the high resistance required for the professional market. With different finishes, colors, combinations and materials, RESOL CONTRACT furniture allows you to find the product you need at every moment.

RESOL CONTRACT offre un large éventail de produits conçus et développés pour les hautes performances requises par le secteur professionnel. Avec de multiples finitions, couleurs, combinaisons et accessoires, le mobilier RESOL CONTRACT vous permet de trouver le produit que vous avez besoin dans chaque situation.

SILLAS Y SILLAS CON BRAZOS _____ 208

CHAIRS AND ARMCHAIRS | CHAISES ET FAUTEUILS

MESAS _____ 248

TABLES | TABLES

TABURETES _____ 288

STOOLS | TABOURETS

SILLONES Y SOFÁS _____ 296

ARMCHAIRS AND SOFAS | FAUTEUILS ET CANAPÉS

SETS _____ 312

SETS | SETS

TUMBONAS Y MESAS AUXILIARES _____ 318

SUN LOUNGERS | BAIN DE SOLEIL

PARASOLES _____ 334

PARASOLS | PARASOLS

PAPELERAS _____ 348

BINS | CORBEILLES

SILLAS Y SILLAS CON BRAZOS

CHAIRS AND ARMCHAIRS | CHAISES ET FAUTEUILS

**SILLAS Y SILLAS CON
BRAZOS | CHAIRS AND ARMCHAIRS**
| CHAISES ET FAUTEUILS

Sky	210	Ibiza	226	Play	242
Sky Lounge	211	Verona	227	Delta	242
Sunset	214	Capri	227	Cool	243
Mila	215	Daytona	228	Iris	243
Snow	216	Panamá	228	Corfu	244
Plus	217	Oslo	230	Creta	244
Miranda	218	Oslo con brazos	230	Palma	244
Bee	219	Kibo	231	Inca	246
Tiffany	219	Cubic	232	Malibú	246
Allegra	219	Shio	232	Maki	247
Miss Bibi	221	Mamba	233	Original	247
Elizabeth	221	Hydra	233		
Diva	221	Dokos	233		
Crystal	223	Aurea	234		
Ares	223	Bissetti	234		
Artemis	223	Malta respaldo alto	235		
Air	224	Malta respaldo bajo	235		
Air XL	224	Edge	238		
Bird	226	Edge aluminio	238		
Florida	226	Edge comfort	238		
		Sea aluminio	239		
		Alegria	239		
		Alegria con brazos	239		

SKY

Sillón | Armchair | Fauteuil



W: ancho / width / largeur. L: largo / length / longueur
H: altura / height / hauteur. Hs: altura asiento / seat height /
hauteur du siège. Ha: altura brazo / arm height / hauteur du bras
Ø: diámetro / diameter / diamètre.

El sillón Sky está fabricado con polipropileno reforzado con fibra de vidrio. Para uso interior y exterior. Se puede desmontar.

Sky armchair is produced with polypropylene reinforced with glass fiber. For indoor and outdoor use. It can be disassembled.

Le fauteuil SKY est fabriqué en polypropylène et renforcé fibre de verre. Pour un usage intérieur et extérieur. Il est démontable.

- Blanco | White | Blanc
- Negro | Black | Noir
- Gris Oscuro | Dark Grey | Gris Foncé

W 54 cm	W 21.26 in
L 60 cm	L 23.62 in
H 81 cm	H 31.89 in
Hs 45 cm	Hs 17.72 in

STD units	Packaging dim. (cm)	M3/ pack	NW units (kg)	Units Container 20'	Units Container 40'	Units Container HC	Units Truck 70m³	Units Truck 100m³
4	58x82x85	0,404	4,8	280	-	684	-	768



SKY LOUNGE

Silla | Chair | Chaise



CATAS Siesta
exclusive

W: ancho / width / largeur. **L:** largo / length / longueur
H: altura / height / hauteur. **Hs:** altura asiento / seat height /
hauteur du siège. **Ha:** altura brazo / arm height / hauteur du bras
Ø: diámetro / diameter / diamètre.

La silla Sky lounge está fabricada con polipropileno reforzado con fibra de vidrio. Para uso interior y exterior. Se puede desmontar.

Sky lounge chair is produced with polypropylene reinforced with glass fiber. For indoor and outdoor use. It can be disassembled.

La chaise SKY est fabriquée en polypropylène et renforcée fibre de verre. Pour un usage intérieur et extérieur. Elle est démontable.

○ Blanco | White | Blanc

● Negro | Black | Noir

● Gris Oscuro | Dark Grey | Gris Foncé

W 60 cm	W 23.62 in
L 71 cm	L 27.95 in
H 83 cm	H 32.68 in
Hs 38 cm	Hs 14.96 in

STD units	Packaging dim. (cm)	M3/pack	NW units (kg)	Units Container 20'	Units Container 40'	Units Container HC	Units Truck 70m³	Units Truck 100m³
4	67x88x83	0,489	5,2	216	-	468	-	684







Sillón Sky (p. 211) y mesa Sky (p. 266)
Sky armchair (p. 211) and Sky table (p. 266)
Sky fauteuil (p. 211) et table Sky (p. 266)

SUNSET

Silla | Chair | Chaise



 Apilable
Stackable | Empilable

 Siesta
exclusive

W: ancho / width / largeur. **L:** largo / length / longueur
H: altura / height / hauteur. **Hs:** altura asiento / seat height /
hauteur du siège. **Ha:** altura brazo / arm height / hauteur du bras
Ø: diámetro / diameter / diamètre.

Silla inyectada en fibra de vidrio y PP mediante tecnología de moldeo asistida por gas. Para uso interior y exterior. Otros colores disponibles consulte al Departamento Comercial.

Chair produced with with fiberglass and PP using gas assisted injection technology. For indoor and outdoor use. Other available colours, contact the Sales Department.

Chaise en fibre de verre et PP à travers la technologie de moulage assistée par gaz. Pour usage intérieur et extérieur. Autres couleurs consultez le département commercial.

○ Blanco | White | Blanc

● Taupe | Taupe | Taupe

● Gris Oscuro | Dark Grey | Gris Foncé

W 64 cm

L 66 cm

H 82 cm

Hs 45 cm

W 25.2 in

L 25.98 in

H 32.28 in

Hs 17.72 in

STD units	Packaging dim. (cm)	M3/ pack	NW units (kg)	Units Container 20'	Units Container 40'	Units Container HC	Units Truck 70m ³	Units Truck 100m ³
4	55x74x98	0,40	4,2	256	640	640	-	720



MILA

Silla con brazos | Armchair | Fauteuil



 Apilable
Stackable | Empilable

 Siesta
exclusivo

W: ancho / width / largeur. **L:** largo / length / longueur
H: altura / height / hauteur. **Hs:** altura asiento / seat height /
hauteur du siège. **Ha:** altura brazo / arm height / hauteur du bras
Ø: diámetro / diameter / diamètre.

Sillón apilable para uso interior y exterior. Fabricado con inyección de PP reforzado con fibra de vidrio y obtenida mediante tecnología de moldeo por gas. Otros colores disponibles, consulte al Departamento Comercial.

Armchair is produced with fiberglass and PP using gas assisted injection technology. For indoor and outdoor use. Other available colours, contact the Sales Department.

Fauteuil empilable pour usage intérieur et extérieur. Fabriqué par injection de PP et fibre de verre, en utilisant technologie de moulage assistée par gaz. Autres couleurs disponibles, consultez le Département Commerciale.

○ Blanco | White | Blanc

● Negro | Black | Noir

● Gris Oscuro | Dark Grey | Gris Foncé

W 57 cm	W 22.44 in
L 56 cm	L 22.05 in
H 82 cm	H 32.28 in
Hs 46 cm	Hs 18.11 in

STD units	Packaging dim. (cm)	M3/pack	NW units (kg)	Units Container 20'	Units Container 40'	Units Container HC	Units Truck 70m³	Units Truck 100m³
4	55x74x98	0,42	4,25	256	640	640	-	720



SNOW

Silla | Chair | Chaise



 Apilable
Stackable | Empilable

 Siesta
exclusiva

W: ancho / width / largeur. **L:** largo / length / longueur
H: altura / height / hauteur. **Hs:** altura asiento / seat height /
hauteur du siège. **Ha:** altura brazo / arm height / hauteur du bras
Ø: diámetro / diameter / diamètre.

Silla inyectada en fibra de vidrio y PP mediante tecnología de moldeo por gas. Para uso interior y exterior. Otros colores disponibles consulte al Departamento Comercial.

Chair produced with a single injection of polypropylene reinforced with fiberglass and PP using gas assisted injection Technology. For indoor and outdoor use. Other available colours, contact the Sales Department.

Chaise en fibre de verre et PP à travers la technologie de moulage assistée par gaz. Pour usage intérieur et extérieur. Autres couleurs consultez le département commercial.

- Blanco | White | Blanc
- Negro | Black | Noir
- Gris Oscuro | Dark Grey | Gris Foncé

W 52 cm	W 20.47 in
L 56 cm	L 22.04 in
H 83 cm	H 32.67 in

STD units	Packaging dim. (cm)	M3/ pack	NW units (kg)	Units Container 20'	Units Container 40'	Units Container HC	Units Truck 70m ³	Units Truck 100m ³
22	53x95x230	1,27	4,4	528	1.100	1.100	-	1.232



PLUS

Silla con brazos | Armchair | Fauteuil



Apilable
Stackable | Empilable

Siesta
exclusive

W: ancho / width / largeur. **L:** largo / length / longueur
H: altura / height / hauteur. **Hs:** altura asiento / seat height /
hauteur du siège. **Ha:** altura brazo / arm height / hauteur du bras
Ø: diámetro / diameter / diamètre.

Silla con brazos inyectada en fibra de vidrio y PP mediante tecnología de moldeo por gas. Para uso interior y exterior. Otros colores disponibles consulte al Departamento Comercial.

Armchair is produced with a single injection of polypropylene reinforced with glass fiber obtained by gas assisted injection technology. For indoor and outdoor use. Other available colours, contact the Sales Department.

Fauteuil en fibre de verre et PP à travers la technologie de moulage assistée par gaz. Pour usage intérieur et extérieur. Autres couleurs disponibles, consultez le département commercial.

○ Blanco | White | Blanc

● Negro | Black | Noir

W 58 cm
L 55 cm
H 84 cm
Hs 46 cm

W 22.83 in
L 21.65 in
H 33.07 in
Hs 18.11 in

STD units	Packaging dim. (cm)	M3/pack	NW units (kg)	Units Container 20'	Units Container 40'	Units Container HC	Units Truck 70m³	Units Truck 100m³
22	58x95x230	1,27	6,8	528	1.100	1.100	-	1.232



MIRANDA

Silla | Chair | Chaise



Siesta
exclusive

Silla inyectada en fibra de vidrio y PP mediante tecnología de moldeo asistida por gas. Para uso interior y exterior. Otros colores disponibles, consulte al Departamento Comercial.

Chair injected with fiberglass and PP using gas assisted injection technology. For indoor and outdoor use. Other available colours, contact the Sales Department.

Chaise injectée avec fibre de verre et PP, en utilisant technologie de moulage assistée par gaz. Pour intérieur et extérieur. Autres couleurs disponibles, consultez le Département Commerciale.



Miranda Test
Certificates:
EN 581-1
Public



○ Blanco | White | Blanc

● Negro | Black | Noir

W 45 cm

L 56 cm

H 94 cm

Hs 47 cm

W 17.72 in

L 22.05 in

H 33.01 in

Hs 18.50 in

W: ancho / width / largeur. L: largo / length / longueur

H: altura / height / hauteur. Hs: altura asiento / seat height / hauteur du siège. Ha: altura brazo / arm height / hauteur du bras

Ø: diámetro / diameter / diamètre.

STD units	Packaging dim. (cm)	M3/ pack	NW units (kg)	Units Container 20'	Units Container 40'	Units Container HC	Units Truck 70m³	Units Truck 100m³
4	47x72x115	0,38	4	320	664	664	-	888



BEE

Silla | Chair | Chaise



Siesta
exclusive



Bee Test
Certificates:
EN
15373 L2
CATAS

W 54 cm
L 46 cm
H 87 cm
Hs 46 cm

W 21.26 in
L 18.11 in
H 34.25 in
Hs 18.11 in

Silla apilable para uso interior y exterior de policarbonato. Tratamiento antiarañazos y protección UV. Peso neto 3,7 kg. Otros colores disponibles, consulte al Departamento Comercial.

Stackable chair for indoor and outdoor use, in polycarbonate. Scratch resistant. UV protection. Net weight 3,7 kg (8.16 lb). Other available colours, contact the Sales Department.

Chaise empilable pour usage intérieur et extérieur, en polycarbonate. Antirayure et UV protection. Poids net 3,7 kg. Autres couleurs disponibles, consultez le Département.

Transparente | Transparent | Transparent

Negro | Black | Noir

Blanco | White | Blanc

STD units	Packaging dim. (cm)	M3/ pack	NW units (kg)	Units Container 20'	Units Container 40'	Units Container HC	Units Truck 70m ³	Units Truck 100m ³
4	47x69x104	0,34	3,7	320	816	816	-	840

TIFFANY

Silla | Chair | Chaise



Siesta
exclusive



Apilable
Stackable | Empilable

Silla apilable para uso interior y exterior, inyectada en polipropileno con fibra de vidrio mediante tecnología "Air Moulding Process". Protección UV. Peso neto 3,25 kg. Otros colores disponibles, consulte al Departamento Comercial.

Stackable chair for indoor and outdoor use, injected in polypropylene with fiberglass with the "Air Moulding Process". UV protection. Net weight 3,25 kg (7.17 lb). Other available colours, contact the Sales Department.

Chaise empilable pour usage intérieur et extérieur, injectée en polypropylène avec fibre de verre avec la technologie "Air Moulding Process". Protection UV. Poids net 3,25 kg. Autres couleurs disponibles, consultez le Département Commerciale.

Blanco | White | Blanc

Marron | Brown | Marron



Tiffany Test
Certificates:
EN 581
Public
CATAS

W 51 cm
L 45 cm
H 85 cm
Hs 45 cm

W 20.08 in
L 17.72 in
H 33.46 in
Hs 17.72 in

STD units	Packaging dim. (cm)	M3/ pack	NW units (kg)	Units Container 20'	Units Container 40'	Units Container HC	Units Truck 70m ³	Units Truck 100m ³
4	58,5x73,5x103	0,44	3,25	272	552	616	632	840
24	46x95x230	1,00	3,25	720	1.560	1.560	-	1.680

ALLEGRA

Silla | Chair | Chaise



Siesta
exclusive



Apilable
Stackable | Empilable

Silla apilable para uso interior. Policarbonato reciclable y patas tubulares de acero cromado. Otros colores disponibles, consulte al Departamento Comercial.

Stackable chair for indoor use. Recyclable polycarbonate main body. Legs frame in tubular chrome steel. Other available colours, contact the Sales Department.

Chaise empilable pur usage intérieur. Polycarbonate recyclable et pieds chromés en acier tubulaire. Autres couleurs disponibles, consultez le Département Commerciale.

Translucido | Translucent | Translucide

Hasta fin de existencias | Until the end of stock |
Jusqu'à epuiseement du stock

W 50 cm
L 54 cm
H 84 cm
Hs 44 cm

W 19.69 in
L 21.26 in
H 33.07 in
Hs 17.32 in

STD units	Packaging dim. (cm)	M3/ pack	NW units (kg)	Units Container 20'	Units Container 40'	Units Container HC	Units Truck 70m ³	Units Truck 100m ³
4	52x70x99	0,36	5,5	264	552	552	760	760

W: ancho / width / largeur. L: largo / length / longueur
H: altura / height / hauteur. Hs: altura asiento / seat height / hauteur du siège. Ha: altura brazo / arm height / hauteur du bras
Ø: diámetro / diameter / diamètre.



Silla Elizabeth (p.221)
Elizabeth chair (p.221)
Chaise Elizabeth (p.221)

MISS BIBI

Silla | Chair | Chaise



Siesta



Miss Bibi Test
Certificates:
EN
15373 L2



W 42 cm
L 50 cm
H 85 cm
Hs 47 cm

W 16.54 in
L 19.69 in
H 33.46 in
Hs 18.50 in

Silla apilable para uso interior y exterior. Inyectada con la tecnología "Air Moulding Process". Asiento en polipropileno reforzado con fibra de vidrio, respaldo en policarbonato transparente. Otros colores disponibles, consulte al Departamento Comercial.

Stackable chair for indoor and outdoor use. Injected with the "Air Moulding Process" technology. Seat in polypropylene reinforced with fiberglass, polycarbonate backing. Other available colours, contact the Sales Department.

Chaise empilable pour usage intérieur et extérieur. Injectée avec la technologie "Air Process Moulding". Assise en polypropylène renforcé de fibre de verre, la dossier en polycarbonate. Autres couleurs disponibles, consultez le Département Commerciale.

● Negro | Black | Noir

○ Transparente/blanco | Transparent/white | Transparent/blanc

STD units	Packaging dim. (cm)	M3/ pack	NW units (kg)	Units Container 20'	Units Container 40'	Units Container HC	Units Truck 70m ³	Units Truck 100m ³
4	48x70x102	0,34	3,95	320	792	792	-	912

ELIZABETH

Silla | Chair | Chaise



Siesta



Elizabeth Test
Certificates:
EN
15373 L2



W 47 cm
L 50 cm
H 90 cm
Hs 45 cm

W 18.50 in
L 19.69 in
H 35.43 in
Hs 17.72 in

Silla apilable para uso interior y exterior. Inyectada en poliamida o policarbonato, protección UV. Aditivos antiarañazos e ignífugos para el modelo de poliamida. Otros colores disponibles, consulte al Departamento Comercial.

Stackable chair for indoor and outdoor use. Injected in polyamide or polycarbonate. UV protection. Antiscratch and fire retardant for polyamide's model. Other available colours, contact the Sales Department.

Chaise empilable pour intérieur et extérieur. Injectée en polyamide ou polycarbonate. Protection UV. Traitement anti rayures et anti feu pour la chaise en polyamide. Autres couleurs disponibles, consultez le Département Commerciale.

○ Transparente | Transparent | Transparent

● Negro | Black | Noir

○ Blanco | White | Blanc

STD units	Packaging dim. (cm)	M3/ pack	NW units (kg)	Units Container 20'	Units Container 40'	Units Container HC	Units Truck 70m ³	Units Truck 100m ³
4	48x69x109	0,36	4,5	320	792	792	-	912

DIVA

Silla con brazos | Armchair | Fauteuil



Siesta



Diva Test
Certificates:
EN
15373 L2

W 57 cm
L 53 cm
H 84 cm
Hs 45 cm

W 22.44 in
L 20.87 in
H 33.07 in
Hs 17.72 in

● Negro | Black | Noir

○ Blanco | White | Blanc

Sillón apilable de polipropileno con fibra de vidrio para uso interior y exterior. Inyectada con la tecnología "Air Moulding Process". Protección UV. Otros colores disponibles, consulte al Departamento Comercial.

Stackable fiberglass polypropylene armchair for indoor and outdoor use. Injected with the "Air Moulding Process" technology. UV protection. Other available colours, contact the Sales Department.

Fauteuil empilable en polypropylène avec fibre de verre pour usage intérieur et extérieur. Injectée avec la technologie "Air moulding process". Protection U.V. Autres couleurs disponibles, consultez le Département Commerciale.



Apilable

Stackable | Empilable

W: ancho / width / largeur. L: largo / length / longueur

H: altura / height / hauteur. Hs: altura asiento / seat height / hauteur du siège. Ha: altura brazo / arm height / hauteur du bras

Ø: diámetro / diameter / diamètre.

STD units	Packaging dim. (cm)	M3/ pack	NW units (kg)	Units Container 20'	Units Container 40'	Units Container HC	Units Truck 70m ³	Units Truck 100m ³
4	58,3x73,5x103	0,44	4,15	272	552	616	632	840
22	58x95x227	1,24	4,15	600	1.240	1.240	-	1.400

Silla Ares (p.223) y mesa Ares 80 (p.268)
Ares chair (p.223) and Ares 80 table (p.268)
Chaise Ares (p.223) et table Ares 80 (p.268)



CRYSTAL

Silla | Chair | Chaise



Silla apilable para uso interior y exterior. Inyectada en policarbonato, protección UV. Otros colores disponibles, consulte al Departamento Comercial.

Stackable chair for indoor and outdoor use. Injected in polycarbonate, UV protection. Other available colours, contact the Sales Department.

Chaise empilable pour intérieur et extérieur. Injectée en polycarbonate, protection UV. Autres couleurs disponibles, consultez le Département Commerciale.



● **Transparente | Transparent | Transparent**
○ **Blanco | White | Blanc**

W 59 cm	W 23.23 in
L 60 cm	L 23.62 in
H 80 cm	H 31.50 in
Hs 45 cm	Hs 17.72 in

Apilable
Stackable | Empilable



STD units	Packaging dim. (cm)	M3/ pack	NW units (kg)	Units Container 20'	Units Container 40'	Units Container HC	Units Truck 70m³	Units Truck 100m³
4	59x79x92	0,43	5	216	592	592	-	816

ARES

Silla | Chair | Chaise



Silla inyectada en fibra de vidrio y PP mediante tecnología de moldeo asistida por gas. Apilable. Para uso interior y exterior. Protección UV. Otros colores disponibles, consulte al Departamento Comercial.

Chair injected with fibreglass and PP using gas assisted injection technology. Stackable. For indoor and outdoor use. UV Protection. Other available colours, contact the Sales Department.

Chaise injectée avec fibre de verre et PP, en utilisant technologie de moulage assistée par gaz. Empilable. Protection UV. Autres couleurs disponibles, consultez le Département Commerciale.



○ **Blanco | White | Blanc**
● **Negro | Black | Noir**

W 48 cm	W 18.90 in
L 58 cm	L 22.83 in
H 82 cm	H 32.28 in
Hs 45 cm	Hs 17.72 in

Apilable
Stackable | Empilable



STD units	Packaging dim. (cm)	M3/ pack	NW units (kg)	Units Container 20'	Units Container 40'	Units Container HC	Units Truck 70m³	Units Truck 100m³
4	58,3x73,5x103	0,44	4,5	272	552	616	632	840
22	48x95x230	1,07	4,5	576	1.248	1.248	-	1.344

ARTEMIS

Silla con brazos | Armchair | Fauteuil



Silla con brazos inyectada en fibra de vidrio y PP mediante tecnología de moldeo asistida por gas. Apilable. Para uso interior y exterior. Protección UV. Otros colores disponibles, consulte al Departamento Comercial.

Armchair injected with fibreglass and PP using gas assisted injection technology. Stackable. For indoor and outdoor use. UV Protection. Other available colours, contact the Sales Department.

Fauteuil injecté avec fibre de verre et PP, en utilisant technologie de moulage assistée par gaz. Empilable. Protection UV. Autres couleurs disponibles, consultez le Département Commerciale.

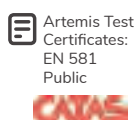

○ **Blanco | White | Blanc**
● **Negro | Black | Noir**

W 71 cm	W 27.95 in
L 89 cm	L 35.04 in
H 76 cm	H 29.92 in
Hs 38 cm	Hs 14.96 in

Apilable
Stackable | Empilable



STD units	Packaging dim. (cm)	M3/ pack	NW units (kg)	Units Container 20'	Units Container 40'	Units Container HC	Units Truck 70m³	Units Truck 100m³
4	58,3x73,5x103	0,44	5	272	552	616	632	840
22	58x95x230	1,26	5	526	1.144	1.144	1.232	1.232

W: ancho / width / largeur. L: largo / length / longueur
H: altura / height / hauteur. Hs: altura asiento / seat height / hauteur du siège. Ha: altura brazo / arm height / hauteur du bras
Ø: diámetro / diameter / diamètre.

AIR

Silla | Chair | Chaise

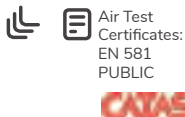

Silla inyectada en fibra de vidrio y PP mediante tecnología de moldeo asistida por gas. Apilable. Para uso interior y exterior. Protección UV. Otros colores disponibles, consulte al Departamento Comercial.

Chair injected with fibreglass and PP using gas assisted injection technology. Stackable. For indoor and outdoor use. UV Protection. Other available colours, contact the Sales Department.

Chaise injectée avec fibre de verre et PP, en utilisant technologie de moulage assistée par gaz. Empilable. Protection UV. Autres couleurs disponibles, consultez le Département Commerciale.

○ Blanco | White | Blanc

● Rojo | Red | Rouge

● Negro | Black | Noir

Siesta
exclusive

W 50 cm	W 19.69 in
L 60 cm	L 23.62 in
H 82 cm	H 32.28 in
Hs 44 cm	Hs 17.32 in

STD units	Packaging dim. (cm)	M3/ pack	NW units (kg)	Units Container 20'	Units Container 40'	Units Container HC	Units Truck 70m ³	Units Truck 100m ³
4	52x77x94	0,36	3,7	320	752	752	936	936

AIR XL

Silla con brazos | Armchair | Fauteuil

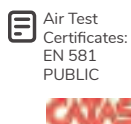

Sillón inyectado en fibra de vidrio y PP mediante tecnología de moldeo asistida por gas. Para uso interior y exterior.

Amchair injected with fiberglass and PP using gas assisted injection technology. For indoor and outdoor use.

Fauteuil injectée avec fibre de verre et PP, en utilisant technologie de moulage assistée par gaz. Pour intérieur et extérieur.

○ Blanco | White | Blanc

● Rojo | Red | Rouge

● Negro | Black | Noir

Siesta
exclusive

W 57 cm	W 22.44 in
L 60 cm	L 23.62 in
H 81 cm	H 31.89 in
Hs 44 cm	Hs 17.32 in

Apilable
Stackable | Empilable

W: ancho / width / largeur. L: largo / length / longueur
H: altura / height / hauteur. Hs: altura asiento / seat height / hauteur du siège. Ha: altura brazo / arm height / hauteur du bras
Ø: diámetro / diameter / diamètre.

STD units	Packaging dim. (cm)	M3/ pack	NW units (kg)	Units Container 20'	Units Container 40'	Units Container HC	Units Truck 70m ³	Units Truck 100m ³
4	58x76x94	0,41	3,8	248	624	624	-	852



BIRD

Silla | Chair | Chaise



Apilable
Stackable | Empilable

W: ancho / width / largeur. L: largo / length / longueur
H: altura / height / hauteur. Hs: altura asiento / seat height /
hauteur du siège. Ha: altura brazo / arm height / hauteur du bras
Ø: diámetro / diameter / diamètre.

Silla apilable para uso interior y exterior fabricado en ratán inyectado. Protección UV.

Stackable chair for indoor and outdoor use made of injected rattan. UV protection.

Chaise empilable pour usage intérieur et extérieur fabriqué en rattan injecté. Protection UV.

- Blanco | White | Blanc
- Chocolate | Chocolate | Chocolat

W 59 cm | W 23.23 in
L 59 cm | L 23.23 in
H 82 cm | H 32.28 in

STD units	Packaging dim. (cm)	M3/ pack	NW units (kg)	Units Container 20'	Units Container 40'	Units Container HC	Units Truck 70m ³	Units Truck 100m ³
5	85x60x106	0,12	3,3	280	600	600	880	880

FLORIDA

Silla | Chair | Chaise



Florida Test Certificates:
EN 581 PUBLIC
CATAS
W 45 cm | W 17.72 in
L 52 cm | L 20.47 in
H 87 cm | H 34.25 in
Hs 45 cm | Hs 17.72 in

Silla apilable para uso interior y exterior fabricada en resina muy resistente y duradera reforzada con fibra de vidrio. Protección UV. Otros colores disponibles, consulte al Departamento Comercial.

Stackable chair for indoor and outdoor use made of very strong and durable resin reinforced with fiberglass. UV protection. Other available colours, contact the Sales Department.

Chaise empilable pour une utilisation intérieure et extérieure fabriquée en résine très solide et durable renforcée avec fibre de verre. Protection UV. Autres couleurs disponibles, consultez le Département Commerciale.

- Blanco | White | Blanc
- Chocolate | Chocolate | Chocolat

Siesta
exclusive

STD units	Packaging dim. (cm)	M3/ pack	NW units (kg)	Units Container 20'	Units Container 40'	Units Container HC	Units Truck 70m ³	Units Truck 100m ³
4	58,5x73,5x103	0,44	4,75	192	416	416	464	464
16	47x91x220	0,94	4	480	1.040	1.040	-	1.260

IBIZA

Silla con brazos | Armchair | Fauteuil



Ibiza Test Certificates:
EN 15373 L2
CATAS
W 58 cm | W 22.83 in
L 59 cm | L 23.23 in
H 87 cm | H 34.25 in
Hs 46 cm | Hs 18.11 in

Sillón apilable para uso interior y exterior fabricado en resina muy resistente y duradera reforzada con fibra de vidrio. Protección UV. Otros colores disponibles, consulte el Departamento Comercial.

Stackable armchair for indoor and outdoor use made of very strong and durable resin reinforced with fiberglass. UV protection. Other available colours, contact the Sales Department.

Fauteuil empilable pour une utilisation intérieure et extérieure fabriqué en résine très solide et durable renforcée avec fibre de verre. Protection UV. Autres couleurs disponibles, consultez le Département Commerciale.

- Blanco | White | Blanc
- Chocolate | Chocolate | Chocolat

Siesta
exclusive

STD units	Packaging dim. (cm)	M3/ pack	NW units (kg)	Units Container 20'	Units Container 40'	Units Container HC	Units Truck 70m ³	Units Truck 100m ³
4	58,5x73,5x103	0,44	4,75	192	416	416	464	464
16	58x93x228	1,23	4,75	384	832	832	1.008	1.008

VERONA

Silla | Chair | Chaise

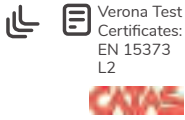

Silla apilable para uso interior y exterior fabricada en resina muy resistente y duradera reforzada con fibra de vidrio. Protección UV. Otros colores disponibles, consulte al Departamento Comercial.

Stackable chair for indoor and outdoor use made of very strong and durable resin reinforced with fiberglass. UV protection. Other available colours, contact the Sales Department.

Chaise empilable pour une utilisation intérieure et extérieure fabriquée en résine très solide et durable renforcée avec fibre de verre. Protection UV. Autres couleurs disponibles, consultez le Département Commerciale.

● Chocolate | Chocolate | Chocolat

Siesta
exclusivo

W 47 cm	W 18.50 in
L 62 cm	L 24.41 in
H 82 cm	H 32.28 in
Hs 45 cm	Hs 17.72 in

STD units	Packaging dim. (cm)	M3/ pack	NW units (kg)	Units Container 20'	Units Container 40'	Units Container HC	Units Truck 70m ³	Units Truck 100m ³
4	58,5x73,5x103	0,44	3,6	192	416	416	464	464
22	102x53x232	1,25	3,6	-	1.012	1.012	1.144	1.144

CAPRI

Silla con brazos | Armchair | Fauteuil

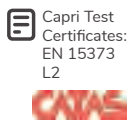

Sillón apilable para uso interior y exterior fabricado en resina muy resistente y duradera reforzada con fibra de vidrio. Protección UV. Otros colores disponibles, consulte el Departamento Comercial.

Stackable armchair for indoor and outdoor use made of very strong and durable resin reinforced with fiberglass. UV protection. Other available colours, contact the Sales Department.

Fauteuil empilable pour une utilisation intérieure et extérieure fabriqué en résine très solide et durable renforcée avec fibre de verre. Protection UV. Autres couleurs disponibles, consultez le Département Commerciale.

● Chocolate | Chocolate | Chocolat

Siesta
exclusivo

W 58 cm	W 22.83 in
L 62 cm	L 24.41 in
H 82 cm	H 32.28 in
Hs 45 cm	Hs 17.72 in

Apilable
Stackable | Empilable

W: ancho / width / largeur. L: largo / length / longueur
H: altura / height / hauteur. Hs: altura asiento / seat height / hauteur du siège. Ha: altura brazo / arm height / hauteur du bras
Ø: diámetro / diameter / diamètre.

STD units	Packaging dim. (cm)	M3/ pack	NW units (kg)	Units Container 20'	Units Container 40'	Units Container HC	Units Truck 70m ³	Units Truck 100m ³
4	58,5x73,5x103	0,44	3,6	192	416	416	464	464
22	102x58x232	1,37	4	-	1.012	1.012	1.144	1.144

DAYTONA

Silla | Chair | Chaise



Silla apilable para uso interior y exterior fabricada en resina muy resistente y duradera reforzada con fibra de vidrio. Protección UV. Otros colores disponibles, consulte al Departamento Comercial.

Stackable chair for indoor and outdoor use made of very strong and durable resin reinforced with fiberglass. UV protection. Other available colours, contact the Sales Department.

Chaise empilable pour une utilisation intérieure et extérieure fabriquée en résine très solide et durable renforcée avec fibre de verre. Protection UV. Autres couleurs disponibles, consultez le Département Commerciale

● Chocolate | Chocolate | Chocolat



W 55 cm	W 21.65 in
L 61 cm	L 24.02 in
H 81 cm	H 31.89 in
Hs 45 cm	Hs 17.72 in

STD units	Packaging dim. (cm)	M3/ pack	NW units (kg)	Units Container 20'	Units Container 40'	Units Container HC	Units Truck 70m ³	Units Truck 100m ³
4	58,5x73,5x103	0,44	3,5	192	416	416	464	464
18	55x224x95	1,17	3,5	432	900	900	1.120	1.120

PANAMA

Silla con brazos | Armchair | Fauteuil



Panama Test Certificates: EN 581 public



Sillón apilable para uso interior y exterior fabricada en resina muy resistente y duradera reforzada con fibra de vidrio. Protección UV. Otros colores disponibles, consulte el Departamento Comercial.

Stackable armchair for indoor and outdoor use made of very strong and durable resin reinforced with fiberglass. UV protection. Other available colours, contact the Sales Department.

Fauteuil empilable pour une utilisation intérieure et extérieure fabriquée en résine très solide et durable renforcée avec fibre de verre. Protection UV. Autres couleurs disponibles, consultez le Département Commerciale.

● Chocolate | Chocolate | Chocolat



W 58 cm	W 22.83 in
L 64 cm	L 25.19 in
H 80 cm	H 31.49 in
Hs 45 cm	Hs 17.71 in

Apilable Stackable | Empilable

W: ancho / width / largeur. L: largo / length / longueur
 H: altura / height / hauteur. Hs: altura asiento / seat height / hauteur du siège. Ha: altura brazo / arm height / hauteur du bras
 Ø: diámetro / diameter / diamètre.

STD units	Packaging dim. (cm)	M3/ pack	NW units (kg)	Units Container 20'	Units Container 40'	Units Container HC	Units Truck 70m ³	Units Truck 100m ³
4	58,5x73,5x103	0,44	4,35	192	416	416	464	464
16	58x95x225	1,24	4,35	384	800	800	1.008	1.008

Silla Daytona (p.228) y mesa Orlando 80 (p.271)
Daytona chair (p.228) and Orlando 80 (p.271)
Chaise Daytona (p.228) avec table Orlando 80 (p.271)



OSLO

Silla | Chair | Chaise



Silla con asiento de PP y patas de madera de haya. Para uso interior. Silla combinable con la mesa Wood New Flash (Ver en página 277).

Chair with PP seat and legs made of beech wood. For indoor use. Chair combinable with the Wood New Flash table (See page 277).

Chaise avec siège en PP et pieds en bois de hêtre. Pour usage intérieur. Chaise combinable avec table Wood New Flash (Voir page 277).

W 45 cm	W 17.72 in
L 52 cm	L 20.47 in
H 82,5 cm	H 32.28 in
Hs 44 cm	Hs 17.32 in

- Blanco | White | Blanc
- Gris Piedra | Stone Grey | Gris Pierre
- Café | Coffee | Café

STD units	Packaging dim. (cm)	M3/ pack	NW units (kg)	Units Container 20'	Units Container 40'	Units Container HC	Units Truck 70m ³	Units Truck 100m ³
4	54x54x58	0,17	3,3	640	1.408	1.408	1.600	1.856

OSLO

Silla con brazos | Armchair | Fauteuil



Silla con brazos con asiento de PP y patas de madera de haya. Para uso interior. Silla combinable con la mesa Wood New Flash (Ver en página 277).

Armchair with PP seat and legs made of beech wood. For indoor use. Chair combinable with the Wood New Flash table (See page 277).

Fauteuil avec siège en PP et pieds en bois de hêtre. Pour usage intérieur. Chaise combinable avec table Wood New Flash (Voir page 277).

- Blanco | White | Blanc
- Gris Piedra | Stone Grey | Gris Pierre
- Café | Coffee | Café

W 62 cm	W 24.41 in
L 69 cm	L 27.17 in
H 82 cm	H 32.28 in
Hs 43 cm	Hs 16.93 in

W: ancho / width / largeur. L: largo / length / longueur
 H: altura / height / hauteur. Hs: altura asiento / seat height / hauteur du siège. Ha: altura brazo / arm height / hauteur du bras
 Ø: diámetro / diameter / diamètre.

STD units	Packaging dim. (cm)	M3/ pack	NW units (kg)	Units Container 20'	Units Container 40'	Units Container HC	Units Truck 70m ³	Units Truck 100m ³
4	54x54x58	0,17	4,8	640	1408	1408	1600	1856

KIBO

Silla con brazos | Armchair | Fauteuil



Silla de metal pintada con acabado antiguo. Apilable. Para uso interior y exterior. Combinable con la mesa Kibo (Ver página 278).

Metal seat with antique cream finished. Stackable. For indoor and outdoor use. Combinable with Kibo Table (See page 278).

Chaise en métal peinte avec finition ancienne. Empilable. Pour usage intérieur et extérieur. Combinable avec Table Kibo (Voir page 278).

● Crema | Cream | Crème

W 45 cm | W 17.72 in
L 53 cm | L 20.87 in
H 85 cm | H 33.46 in

STD units	Packaging dim. (cm)	M3/ pack	NW units (kg)	Units Container 20'	Units Container 40'	Units Container HC	Units Truck 70m ³	Units Truck 100m ³
4	57x46x115	0,08	4,9	700	1.512	1.512	928	-



CUBIC

Silla | Chair | Chaise



Sillón apilable para exterior. Estructura de aluminio pintado por pulverización en color gris claro. Asiento y respaldo de Textilene color negro. Embellecedor de madera ultratech en los apoyabrazos. Peso neto 3,2 kg.

Stackable armchair for outdoor use. Powder-coated aluminium frame in light grey. Black Textilene seat and back. Ultratech wood trimming on the armrest. Net weight 3,2 kg (7.05 lb).

Fauteuil empilable pour extérieur. Structure en aluminium peint par pulvérisation gris clair. Siège et dossier Textilène noir. Revêtement en bois ultratech sur les accouvoirs. Poids net 3,2 kg.

● Gris Claro | Light Grey | Gris Clair

W 57 cm	W 22.44 in
L 54 cm	L 21.26 in
H 79 cm	H 31.10 in

STD units	Packaging dim. (cm)	M3/ pack	NW units (kg)	Units Container 20'	Units Container 40'	Units Container HC	Units Truck 70m³	Units Truck 100m³
4	58,5x73,5x103	0,44	3,2	192	416	416	464	464
27	92x50x230	1,06	3,2	-	1.232	1.364	-	1.484

SHIO

Silla con brazos | Armchair | Fauteuil



Sillón apilable para exterior. Estructura de aluminio pintado por pulverización en color blanco. Asiento y respaldo de Textilene de color blanco. Embellecedor de madera ultratech en los apoyabrazos. Uniones de soldadura reforzadas. Peso neto 3 kg.

Stackable armchair for outdoors. Powder-coated aluminium structure in white. Seat and back of white Textilene. Ultratech wood trimming on the armrests. Reinforced welded joints. Net weight 3 kg (6.61 lb).

Fauteuil d'extérieur empilable. Structure en aluminium peint par pulvérisation de couleur blanche. Siège et dossier en Textilène blanc. Revêtement en bois ultratech sur les accouvoirs. Raccords en soudure renforcés. Poids net 3 kg.

○ Blanco | White | Blanc

W 57 cm	W 22.44 in
L 58 cm	L 22.83 in
H 80 cm	H 31.50 in

STD units	Packaging dim. (cm)	M3/ pack	NW units (kg)	Units Container 20'	Units Container 40'	Units Container HC	Units Truck 70m³	Units Truck 100m³
4	58,5x73,5x103	0,44	3	192	416	416	464	464
26	58x92x228	1,22	3	-	1.248	1.248	1456	1.456

W: ancho / width / largeur. L: largo / length / longueur
 H: altura / height / hauteur. Hs: altura asiento / seat height / hauteur du siège. Ha: altura brazo / arm height / hauteur du bras
 Ø: diámetro / diameter / diamètre.

MAMBA

Silla con brazos
| Armchair | Fauteuil



Apilable
Stackable | Empilable

W: ancho / width / largeur. L: largo / length / longueur
H: altura / height / hauteur. Hs: altura asiento / seat height /
hauteur du siège. Ha: altura brazo / arm height / hauteur du bras
Ø: diámetro / diameter / diamètre.

Sillón apilable para exterior. Estructura de aluminio pintado por pulverización en color negro. Asiento y respaldo de Textilene de color negro. Uniones de soldadura reforzados. Peso neto 3 kg.

Stackable armchair for outdoors. Spray painted aluminium structure in black Textilene. Seat and back in black Textilene. Reinforced welded joints. Net weight 3 kg (6.61 lb).

Fauteuil d'extérieur empilable. Structure en aluminium peint par pulvérisation de couleur noir. Siège et dossier en noir. Raccords en soudure renforcés. Poids net 3 kg.

● Negro | Black | Noir



Mamba Test
Certificates:
UNE EN
581 Public

W 57 cm	W 22.44 in
L 57 cm	L 22.44 in
H 80 cm	H 31.50 in



STD units	Packaging dim. (cm)	M3/ pack	NW units (kg)	Units Container 20'	Units Container 40'	Units Container HC	Units Truck 70m³	Units Truck 100m³
4	58,5x73,5x103	0,44	3	192	416	416	464	464
26	59x91x230	1,23	3	-	1.352	1.352	1.568	1.568

HYDRA

Silla con brazos
| Armchair | Fauteuil



W 54 cm	W 21.26 in
L 54 cm	L 21.26 in
H 85 cm	H 33.46 in

Silla apilable de aluminio pintado. Para uso interior y exterior.

Stackable chair. Spray painted aluminium. For indoor and outdoor use.

Chaise empilable. Pulvériser de l'aluminium peint. Pour usage intérieur et extérieur.

□ Cojín Butaca Hydra&Dokos
Hydra&Dokos cushion
Coussin Hydra&Dokos.

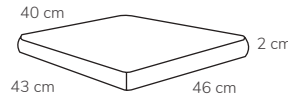

Cojín de poliéster de 2 cm de grosor en color antracita.

Polyester cushion 2 cm thickness in antracite colour.

Coussin polyester de 2 cm de grosseur de couleur antracite.

● Antracita | Antracite | Antracite

STD units	Packaging dim. (cm)	M3/ pack	NW units (kg)	Units Container 20'	Units Container 40'	Units Container HC	Units Truck 70m³	Units Truck 100m³
30	60x60x200	0,72	4,8	600	1.260	1.260	-	-

DOKOS

Silla con brazos |
Armchair | Fauteuil



W 54 cm	W 21.26 in
L 51 cm	L 20.08 in
H 86 cm	H 33.86 in

Silla apilable de aluminio pintado. Para uso interior y exterior.

Stackable chair. Spray painted aluminium. For indoor and outdoor use.

Chaise empilable. Pulvériser de l'aluminium peint. Pour usage intérieur et extérieur.

□ Cojín Butaca Hydra&Dokos
Hydra&Dokos cushion
Coussin Hydra&Dokos.

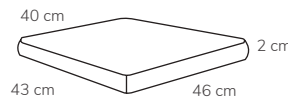

Cojín de poliéster de 2 cm de grosor en color antracita.

Polyester cushion 2 cm thickness in antracite colour.

Coussin polyester de 2 cm de grosseur de couleur antracite.

● Antracita | Antracite | Antracite

STD units	Packaging dim. (cm)	M3/ pack	NW units (kg)	Units Container 20'	Units Container 40'	Units Container HC	Units Truck 70m³	Units Truck 100m³
30	60x60x200	0,72	4,8	600	1.260	1.260	-	-

AUREA

Silla | Chair | Chaise



Silla apilable de aluminio pintado efecto bambú. Asiento y respaldo de textilene. Para uso interior y exterior.

Stackable chair. Spray painted aluminium structure with bamboo looks. Seat and back Textilene. For indoor and outdoor use.

Chaise empilable en aluminium peint effet bambou. Siège et dossier en textilène. Pour usage intérieur et extérieur.

W 57 cm	W 22.44 in
L 57 cm	L 22.44 in
H 82,5 cm	H 32.48 in

STD units	Packaging dim. (cm)	M3/ pack	NW units (kg)	Units Container 20'	Units Container 40'	Units Container HC	Units Truck 70m ³	Units Truck 100m ³
4	54x54x58	0,17	3,3	640	1.408	1.408	1.600	1.856

BISSETTI

Silla | Chair | Chaise



Silla apilable de aluminio pintado efecto bambú. Asiento y respaldo de textilene. Para uso interior y exterior.

Stackable chair. Spray painted aluminium structure with bamboo looks. Seat and back Textilene. For indoor and outdoor use.

Chaise empilable en aluminium peint effet bambou. Siège et dossier en textilène. Pour usage intérieur et extérieur.

W 46 cm	W 18.11 in
L 58 cm	L 22.83 in
H 88 cm	H 34.65 in

STD units	Packaging dim. (cm)	M3/ pack	NW units (kg)	Units Container 20'	Units Container 40'	Units Container HC	Units Truck 70m ³	Units Truck 100m ³
12	68x48x265	0,17	3,01	450	960	960	-	-

W: ancho / width / largeur. L: largo / length / longueur
 H: altura / height / hauteur. Hs: altura asiento / seat height / hauteur du siège. Ha: altura brazo / arm height / hauteur du bras
 Ø: diámetro / diameter / diamètre.

MALTA

DAVID CARRASCO BARCELÓ

Silla con brazos respaldo alto |
High backrest armchair |
Fauteuil dossier haut



Malta Test
Certificates:
EN 581 PUBLIC / en
16139 L1



Sillón apilable para uso interior y exterior fabricado en polipropileno aditivado con protector contra los rayos UV. Patas fabricadas en acero pintado por pulverización al horno con pintura poliéster. Peso neto sillón respaldo alto: 3,90 kg.

Stackable armchair for indoor and outdoor use manufactured in polypropylene with UV protection. Legs made in polyester powder-coating painted steel. Net weight high backrest armchair: 3,90 kg (8.60 lb).

Fauteuil empilable pour une utilisation intérieure et extérieure. Pieds fabriqués en acier peint avec de la peinture polyester. Poids net fauteuil dossier haut: 3,90 kg.

W 58 cm	W 22.83 in
L 56 cm	L 22.05 in
H 75 cm	H 29.53 in
Hs 43 cm	Hs 16.93 in

- Blanco | White | Blanc
- Negro | Black | Noir
- Rojo | Red | Rouge
- Gris Oscuro | Dark Grey | Gris Foncé

STD units	Packaging dim. (cm)	M3/pack	NW units (kg)	Units Container 20'	Units Container 40'	Units Container HC	Units Truck 70m³	Units Truck 100m³
18	62x56x223	0,77	3,9	576	1.440	1.440	1.584	1.872

MALTA

DAVID CARRASCO BARCELÓ

Silla con brazos respaldo bajo |
Low backrest armchair |
Fauteuil dossier bas



Malta Test
Certificates:
EN 581 PUBLIC / en
16139 L1



Sillón apilable para uso interior y exterior fabricado en polipropileno aditivado con protector contra los rayos UV. Patas fabricadas en acero pintado por pulverización al horno con pintura poliéster. Peso neto sillón respaldo bajo 3,80 kg.

Stackable armchair for indoor and outdoor use manufactured in polypropylene with UV protection. Legs made in polyester powder-coating painted steel. Net weight low backrest armchair: 3,80 kg (8.38 lb).

Fauteuil empilable pour une utilisation intérieure et extérieure. Pieds fabriqués en acier peint avec de la peinture polyester. Poids net fauteuil dossier bas: 3,80 kg.

W 58 cm	W 22.83 in
L 56 cm	L 22.05 in
H 72 cm	H 28.35 in
Hs 43 cm	Hs 16.93 in

- Blanco | White | Blanc
- Negro | Black | Noir
- Rojo | Red | Rouge
- Gris Oscuro | Dark Grey | Gris Foncé

STD units	Packaging dim. (cm)	M3/pack	NW units (kg)	Units Container 20'	Units Container 40'	Units Container HC	Units Truck 70m³	Units Truck 100m³
18	65x56x219	0,77	3,8	576	1.440	1.440	1.584	1.872

W: ancho / width / largeur. L: largo / length / longueur
H: altura / height / hauteur. Hs: altura asiento / seat height / hauteur du siège. Ha: altura brazo / arm height / hauteur du bras
Ø: diámetro / diameter / diamètre.



Silla Malta (p. 236) y mesa Malta (p. 280)
Malta chair (p. 236) and Malta table (p. 280)
Chaise Malta (p. 236) et table Malta (p. 280)



EDGE ALUMINIO

Silla con brazos | Armchair | Fauteuil



Edge Test Certificates: UNE EN 581 Public

W 56 cm
L 57 cm
H 81 cm

W 22.05 in
L 22.44 in
H 31.89 in



Sillón apilable para exterior. Estructura tubular doble, \varnothing 25 x 1,20 mm de grosor, de aluminio anodizado brillante. Asiento y respaldo en lamas de aluminio estriado brillante. Tornillos de acero inoxidable, tuercas autoblocantes y conectores de aluminio.

Stackable armchair for outdoor use. Double tubular shaped structure, \varnothing 25 x 1,20 mm thick, anodized aluminium, shiny finish. Seat and back with shiny striated aluminium slats. Stainless steel screws with self-locking nuts and aluminium connectors.

Fauteuil empilable pour extérieur. Structure tubulaire double, \varnothing 25 x 1,20 mm de grosueur, en aluminium anodisé brillant. Lattes du siège et dossier en aluminium brillant. Vis d'acier inoxydable, contre-écrou et entretoises en aluminium.

● Aluminio | Aluminio | Aluminium

STD units	Packaging dim. (cm)	M3/ pack	NW units (kg)	Units Container 20'	Units Container 40'	Units Container HC	Units Truck 70m ³	Units Truck 100m ³
16	66x58x235	0,89	3,32	608	1.216	1.216	1.344	1.472

EDGE

Silla con brazos | Armchair | Fauteuil



Edge Test Certificates: UNE EN 581 Public

W 56 cm
L 57 cm
H 81 cm

W 22.05 in
L 22.44 in
H 31.89 in



Sillón apilable para exterior. Estructura tubular doble, \varnothing 25 x 1,20 mm de grosor, de aluminio anodizado brillante. Asiento y respaldo en PE redondo de 3,50 mm de grosor con nervio interior de acero. Tornillos de acero inoxidable, tuercas autoblocantes y conectores de aluminio.

Stackable armchair for outdoor use. Tubular shaped structure, \varnothing 25 x 1,20 mm thick, anodized aluminium, shiny finish. Round PE seat and back 3,50 mm thick with wire core. Stainless steel screws with self-locking nuts and aluminium connectors.

Fauteuil empilable pour extérieur. Structure tubulaire double, \varnothing 25 x 1,20 mm de grosueur, en aluminium anodisé brillant. Siège et dossier en PE rond de 3,50 mm avec noyau intérieur en d'acier. Vis d'acier inoxydable, contre-écrou et entretoises en aluminium.

● Gris | Grey | Gris

● Arena | Sand | Sable

● Burdeos | Burgundy | Bordeaux

STD units	Packaging dim. (cm)	M3/ pack	NW units (kg)	Units Container 20'	Units Container 40'	Units Container HC	Units Truck 70m ³	Units Truck 100m ³
4	58,5x73,5x103	0,44	3,8	192	400	400	-	448
16	66x58x235	0,89	3,8	-	1.216	1.216	1.344	1.344

EDGE COMFORT

Silla con brazos | Armchair | Fauteuil



Sillón apilable para exterior. Estructura tubular doble, \varnothing 25 x 1,20 mm de grosor, de aluminio anodizado brillante. Asiento y respaldo en PE plano de 0,8 x 1,50 mm de grosor. Tornillos de acero inoxidable, tuercas autoblocantes y conectores de aluminio.

Stackable armchair for outdoor use. Tubular shaped structure, \varnothing 25 x 1,20 mm thick, anodized aluminium, shiny finish. Flat PE seat and back 0.8 x 1.50 mm thickness. Stainless steel screws, self-locking nuts and aluminium connectors.

Fauteuil empilable pour extérieur. Structure tubulaire double, \varnothing 25 x 1,20 mm de grosueur, en aluminium anodisé brillant. Siège et dossier en PE plan de 0,8 x 1,50 mm. Vis en acier inoxydable, contre-écrou et entretoises en aluminium.

● Negro | Black | Noir

W 56 cm
L 57 cm
H 81 cm

W 22.05 in
L 22.44 in
H 31.89 in

STD units	Packaging dim. (cm)	M3/ pack	NW units (kg)	Units Container 20'	Units Container 40'	Units Container HC	Units Truck 70m ³	Units Truck 100m ³
4	58,5x73,5x103	0,44	4,82	148	376	376	-	420
16	66x58x235	0,89	3,8	-	1.216	1.216	1.344	1.344

W: ancho / width / largeur. L: largo / length / longueur

H: altura / height / hauteur. Hs: altura asiento / seat height /

hauteur du siège. Ha: altura brazo / arm height / hauteur du bras

\varnothing : diámetro / diameter / diamètre.

SEA ALUMINIO

Silla con brazos | Armchair | Fauteuil



Edge Test Certificates:
UNE EN 581 Public

SGS

W 49 cm
L 59 cm
H 77 cm

W 19.29 in
L 23.23 in
H 30.31 in

Sillón apilable para exterior. Estructura tubular, ø 25 x 2 mm de grosor, de aluminio anodizado brillante. Asiento y respaldo en lamas de aluminio estriado brillante. Tornillos de acero inoxidable, tuercas autoblocantes y conectores de aluminio.

Stackable armchair for outdoor use. Tubular shaped structure, ø 25 x 2 mm thick, anodized aluminium, shiny finish. Seat and back with shiny striated aluminium slats. Stainless steel screws with self-locking nuts and aluminium connectors.

Fauteuil empilable pour extérieur. Structure tubulaire, ø 25 x 2 mm de grosueur, en aluminium anodisé brillant. Siège et dossier lattes en aluminium brillant. Vis en acier inoxydable, contreécrou et entretoises en aluminium.

● Aluminio | Aluminio | Aluminio

STD units	Packaging dim. (cm)	M3/ pack	NW units (kg)	Units Container 20'	Units Container 40'	Units Container HC	Units Truck 70m³	Units Truck 100m³
4	58,5x73,5x103	0,44	2,7	192	416	416	464	464
16	59x58x235	0,8	2,7	-	1.216	1.216	1.408	1.408

ALEGRIA

Silla | Chair | Chaise



Edge Test Certificates:
UNE EN 581 Public

SGS

W 46 cm
L 57 cm
H 83 cm

W 18.11 in
L 22.44 in
H 32.68 in

Silla apilable para uso interior y exterior de aluminio pintado por pulverización. Disponible en color blanco y negro. Peso neto 3,3 kg.

Stackable chair for indoor and outdoor use in powder coated aluminium. Available in white and black. Net weight 3,3 kg (7.27 lb).

Chaise empilable pour usage intérieur et extérieur en aluminium peint par pulvérisation. Disponible en couleur blanche et noire. Poids net 3,3 kg.

○ Blanco | White | Blanc

● Negro | Black | Noir

W 46 cm
L 57 cm
H 83 cm

W 18.11 in
L 22.44 in
H 32.68 in

STD units	Packaging dim. (cm)	M3/ pack	NW units (kg)	Units Container 20'	Units Container 40'	Units Container HC	Units Truck 70m³	Units Truck 100m³
4	58,5x73,5x103	0,44	3,3	192	416	416	464	464
28	92x50x230	1,06	3,3	-	1.232	1.364	-	1.484

ALEGRIA

Silla con brazos | Armchair | Fauteuil



Silla con brazos apilable para uso interior y exterior de aluminio pintado por pulverización. Disponible en color blanco y negro. Peso neto 3,7 kg.

Stackable armchair for indoor and outdoor use in powder coated aluminium. Available in white and black. Net weight 3,7 kg (8.16 lb).

Fauteuil empilable pour usage intérieur et extérieur en aluminium peint par pulvérisation. Disponible en couleur blanc et noir. Poids net 3,7 kg.



Sea Test Certificates:
UNE EN 581 Public

SGS

○ Blanco | White | Blanc

● Negro | Black | Noir

W 55 cm
L 57 cm
H 83 cm

W 21.65 in
L 22.44 in
H 32.68 in

STD units	Packaging dim. (cm)	M3/ pack	NW units (kg)	Units Container 20'	Units Container 40'	Units Container HC	Units Truck 70m³	Units Truck 100m³
4	58,5x73,5x103	0,44	3,7	192	416	416	464	464
28	92x58x230	1,23	3,7	-	1.232	1.364	-	1.484

W: ancho / width / largeur. L: largo / length / longueur
H: altura / height / hauteur. Hs: altura asiento / seat height / hauteur du siège. Ha: altura brazo / arm height / hauteur du bras
Ø: diámetro / diameter / diamètre.

Silla Alegría (p. 239) y mesa Alegría (p. 274)
Alegría chair (p. 239) and Alegría table (p. 274)
Chaise Alegría (p. 239) et table Alegría (p. 274)





PLAY

Silla con brazos | Armchair | Fauteuil



Silla para uso interior y exterior.
Inyectada en PP. Apilable. Protección UV. Peso neto 2,8 kg.

Chair for indoor and outdoor use.
Injected with PP. Stackable. UV protection. Chair's net weight 2,8 kg.

Chaise pour l'usage intérieur et extérieur. Injectée avec PP. Empilable. Protection UV. Poids net chaise 2,8 kg.

W 57 cm	W 22.44 in
L 54 cm	L 21.26 in
H 78.6 cm	H 30.94 in

- Arena | Sand | Sable
- Blanco | White | Blanc
- Chocolate | Chocolate | Chocolat
- Gris Oscuro | Dark Grey | Gris Foncé
- Azul Retro | Retro Blue | Retro Bleu
- Rojo | Red | Rouge

STD units	Packaging dim. (cm)	M3/ pack	NW units (kg)	Units Container 20'	Units Container 40'	Units Container HC	Units Truck 70m³	Units Truck 100m³
4	60x57x105	0,36	2,8	344	696	800	830	960
27	60x56x220	0,74	2,8	1.080	2.160	2.160	2.592	3.024
P124	120x112x240	3,06	2,8	-	-	2.480	2.976	3.472

DELTA

Silla con brazos | Armchair | Fauteuil



Delta Test
Certificates:
UNE EN 581 PUBLIC
UNE EN 16139 L1



Monoblock armchair for indoor and outdoor use. Stackable and resistant. Injected with fiberglass and polypropylene. UV protection.

Sillón monobloc para uso interior y exterior. Apilable y resistente. Inyectado en polipropileno y fibra de vidrio. Protección contra rayos UVA.

Fauteuil monobloque d'intérieur et extérieur. Empilable et résistant. Injectée avec fibre de verre et polypropylène. Protection contre les rayons UV.

W 53,8 cm	W 21.18 in
L 55 cm	L 21.65 in
H 80,8 cm	H 31.81 in

- Naranja | Orange | Orange
- Verde Lima | Lime Green | Vert Lime
- Gris Oscuro | Dark Grey | Gris Foncé
- Chocolate | Chocolate | Chocolat
- Blanco | White | Blanc
- Arena | Sand | Sable
- Violeta | Violet | Violet

STD units	Packaging dim. (cm)	M3/ pack	NW units (kg)	Units Container 20'	Units Container 40'	Units Container HC	Units Truck 70m³	Units Truck 100m³
24	57x53x222	0,67	3,2	1.056	2.112	2.112	2.400	2.856
108	106x115x240	2,92	3,2	-	-	2.376	2.592	3.240

COOL

Silla con brazos | Armchair | Fauteuil



Cool Test
Certificates:
UNE EN
581



Sillón para uso exterior. Inyectado en polipropileno. Apilable. Asiento texturizado. Tacos de goma antideslizantes. Peso neto: 3,18 kg. Protección UV.

Armchair for outdoor use. Injected with polypropylene. Stackable. Texturized seat. Rubber non-slip feet. Net weight: 3,18 kg (7.01 lb). UV Protection.

Fauteuil pour extérieur. Injectée en polypropylène. Empilable. Siège granité. Patins de caoutchouc antidérapants. Poids net: 3,18 kg. Protection UV.

W 58 cm	W 22.83 in
L 60 cm	L 23.62 in
H 79 cm	H 31.10 in

- Arena | Sand | Sable
- Violeta | Violeta | Violeta
- Blanco | White | Blanc
- Verde Lima | Lime Green | Citron Vert
- Chocolate | Chocolate | Chocolat
- Naranja | Orange | Orange
- Gris Oscuro | Dark Grey | Gris Foncé

STD units	Packaging dim. (cm)	M3/ pack	NW units (kg)	Units Container 20'	Units Container 40'	Units Container HC	Units Truck 70m³	Units Truck 100m³
31	60x60x220	0,79	3,18	837	1.860	1.860	2.635	3.162
132	120x120x232	3,34	3,18	1.056	2.640	2.640	2.904	3.432

IRIS

Silla con brazos | Armchair | Fauteuil



Iris Test
Certificates:
UNE EN
581



Silla para uso interior y exterior. Inyectada en polipropileno. Apilable. Tacos de goma antideslizante. Peso neto: 2,85 kg. UV Protección.

Chair for indoor and outdoor use. Injected with polypropylene. Stackable. Rubber non-slip feet. Net weight: 2,85 kg (6.28 lb). Protection UV.

Chaise d'intérieur et extérieur. Injectée en polypropylène. Empilable. Patins de caoutchouc antidérapants. Poids net: 2,85 kg. Protection UV.

- Violeta | Violeta | Violeta
- Gris Oscuro | Dark Grey | Gris Foncé
- Blanco | White | Blanc
- Verde Lima | Lime Green | Citron Vert

W 43 cm	W 16.93 in
L 47 cm	L 18.50 in
H 88 cm	H 34.65 in

Apilable
Stackable | Empilable

W: ancho / width / largeur. L: largo / length / longueur
H: altura / height / hauteur. Hs: altura asiento / seat height / hauteur du siège. Ha: altura brazo / arm height / hauteur du bras
Ø: diámetro / diameter / diamètre.

STD units	Packaging dim. (cm)	M3/ pack	NW units (kg)	Units Container 20'	Units Container 40'	Units Container HC	Units Truck 70m³	Units Truck 100m³
30	66x49x224	1,36	2,85	1.230	2.520	2.520	2.790	3.250

CORFU

Silla con brazos | Armchair | Fauteuil



Sillón para uso exterior. Apilable. Inyectado en polipropileno. Peso neto 3,22 kg. Protección UV. Acabado texturizado mate.

Armchair for outdoor use. Stackable. Injected with polypropylene. Net weight 3,22 kg (7.10 lb). UV Protection. Textured matt finish.

Fauteuil pour extérieur. Injectée en polypropylène. Empilable. Poids net 3,22 kg. Protection UV. Finition texturée mate.



Corfu Test Certificates: UNE EN 581 Public / 16139 L1



○ Blanco | White | Blanc

● Gris Oscuro | Dark Grey | Gris Foncé

W 58 cm

L 63 cm

H 91 cm

W 22.83 in

L 24.80 in

H 35.83 in

STD units	Packaging dim. (cm)	M3/ pack	NW units (kg)	Units Container 20'	Units Container 40'	Units Container HC	Units Truck 70m ³	Units Truck 100m ³
22	87x56x210	1,02	3,20	572	1.210	1.210	1.386	1.650

CRETA

Silla con brazos | Armchair | Fauteuil



Sillón apilable para exterior de polipropileno inyectado. Peso neto 3,02 kg. Protección UV. Acabado texturizado mate.

Armchair for outdoor use. Injected with polypropylene. Stackable. Net weight 3,02 kg (6.66 lb). UV Protection. Textured matt finish.

Fauteuil empilable pour extérieur en polypropylène. Poids net 3,02 kg. Protection UV. Finition texturée mate.



Creta Test Certificates: UNE EN 581 Public / 16139 L1



○ Blanco | White | Blanc

● Antracita | Antracite | Antracite

W 56 cm

L 58 cm

H 82 cm

W 22.05 in

L 22.83 in

H 32.28 in

STD units	Packaging dim. (cm)	M3/ pack	NW units (kg)	Units Container 20'	Units Container 40'	Units Container HC	Units Truck 70m ³	Units Truck 100m ³
32	57x60x220	0,75	3,02	1.280	2.624	2.624	2.944	3.520
144	120x115x238	3,28	3,02	1.152	2.880	2.880	3.168	4.032

PALMA

Silla con brazos | Armchair | Fauteuil



Sillón para uso exterior. Inyectado en polipropileno. Apilable. Peso neto 2,60 kg. Protección UV.

Armchair for outdoor use. Injected with polypropylene. Stackable. Net weight 2,60 kg (5.73 lb). UV Protection.

Fauteuil pour extérieur. Injectée en polypropylène. Empilable. Poids net 2,60 kg. Protection UV.



Palma Test Certificates: EN 581



○ Blanco | White | Blanc

● Verde Oscuro | Dark Green | Vert Foncé

● Antracita | Antracite | Antracite

W 62 cm

L 55 cm

H 84 cm

W 24.41 in

L 21.65 in

H 33.07 in

STD units	Packaging dim. (cm)	M3/ pack	NW units (kg)	Units Container 20'	Units Container 40'	Units Container HC	Units Truck 70m ³	Units Truck 100m ³
25	62x55x220	0,75	2,6	975	2.000	2.000	2.275	2.750
116	120x115x245	3,38	2,6	-	2.320	2.320	2.552	3.248

W: ancho / width / largeur. L: largo / length / longueur
 H: altura / height / hauteur. Hs: altura asiento / seat height / hauteur du siège. Ha: altura brazo / arm height / hauteur du bras
 Ø: diámetro / diameter / diamètre.



INCA

Silla con brazos |
Armchair | Fauteuil



Sillón apilable para uso exterior. Inyectado en polipropileno. Peso neto 2,60 kg. Protección UV.

Armchair for outdoor use. Injected with polypropylene. Stackable. Net weight 2,60 kg (5.72 lb). UV Protection.

Fauteuil pour extérieur. Injectée en polypropylène. Empilable. Poids net 2,60 kg. Protection UV.

Blanco | White | Blanc

Antracita | Antracite | Antracite

W 62 cm	W 24.41 in
L 55 cm	L 21.65 in
H 84 cm	H 33.07 in

STD units	Packaging dim. (cm)	M3/ pack	NW units (kg)	Units Container 20'	Units Container 40'	Units Container HC	Units Truck 70m ³	Units Truck 100m ³
25	62x55x220	0,75	2,6	975	2.000	2.000	2.275	2.750
116	120x115x245	3,38	2,6	-	2.320	2.320	2.552	3.248

MALIBU

Silla con brazos |
Armchair | Fauteuil



Sillón para uso exterior. Inyectado en polipropileno. Apilable. Patas tubulares muy resistentes. Peso neto 3,90 kg. Protección UV.

Armchair for outdoor use. Injected with polypropylene. Stackable. Resistant tubular legs. Net weight 3,90 kg (8.58 lb). UV Protection.

Fauteuil pour extérieur. Injectée en polypropylène. Empilable. Pieds tubulaires très résistant. Poids net 3,90 kg. Protection UV.

Blanco | White | Blanc

Verde Oscuro | Dark Green | Vert Foncé

W 48 cm	W 18.90 in
L 58 cm	L 22.83 in
H 90 cm	H 35.43 in

Siesta
SILLAS Y SILLAS CON BRAZOS

Apilable
Stackable | Empilable

W: ancho / width / largeur. L: largo / length / longueur
H: altura / height / hauteur. Hs: altura asiento / seat height /
hauteur du siège. Ha: altura brazo / arm height / hauteur du bras
Ø: diámetro / diameter / diamètre.

STD units	Packaging dim. (cm)	M3/ pack	NW units (kg)	Units Container 20'	Units Container 40'	Units Container HC	Units Truck 70m ³	Units Truck 100m ³
24	96x62x258	1,54	3,9	-	-	1.152	1.344	1.440

MAKI

Silla con brazos |
Armchair | Fauteuil



Sillón para uso exterior. Inyectado en polipropileno. Apilable. Patas tubulares muy resistentes. Peso neto: 3,67 kg. Protección UV.

Armchair for outdoor use. Injected with polypropylene. Stackable. Tubular resistant legs. Net weight: 3,67 kg. (8.07 lb). UV Protection.

Fauteuil pour extérieur. Injectée en propylène. Empilable. Pieds tubulaires très résistant. Poids net: 3,67 kg. Protection UV.

● Onyx | Onyx | Onyx

W 48 cm	W 18.90 in
L 58 cm	L 22.83 in
H 90 cm	H 35.43 in

Siesta
exclusive

STD units	Packaging dim. (cm)	M3/ pack	NW units (kg)	Units Container 20'	Units Container 40'	Units Container HC	Units Truck 70m ³	Units Truck 100m ³
24	96x62x258	1,54	3,9	-	-	1.152	1.344	1.440

ORIGINAL

Silla con brazos |
Armchair | Fauteuil



Sillón para uso exterior. Inyectado en polipropileno. Apilable. Peso neto: 3 kg. Protección UV.

Armchair for outdoor use. Injected with polypropylene. Stackable. Net weight 3 kg (6.61 lb). UV Protection.

Fauteuil pour extérieur. Injectée en propylène. Empilable. Poids net 3 kg. Protection UV.

● Onyx | Onyx | Onyx

W 55 cm	W 21.65 in
L 54 cm	L 21.26 in
H 90 cm	H 35.43 in

Siesta
exclusive

Apilable
Stackable | Empilable

W: ancho / width / largeur. L: largo / length / longueur
H: altura / height / hauteur. Hs: altura asiento / seat height /
hauteur du siège. Ha: altura brazo / arm height / hauteur du bras
Ø: diámetro / diameter / diamètre.

STD units	Packaging dim. (cm)	M3/ pack	NW units (kg)	Units Container 20'	Units Container 40'	Units Container HC	Units Truck 70m ³	Units Truck 100m ³
30	96X62X258	1,54	3	-	-	1.152	1.344	1.440

MESAS

TABLES | TABLES

MESAS PIE CENTRAL

PEDESTAL BASE TABLES |

TABLES PIED CENTRAL

Renoir 40x40	251
Renoir ø40	251
Miró 40x40	252
Miró ø40	252
Tapies 40x40	253
Tapies ø40	253
Max	254
Neo	254
Ibiza S	255
Ibiza M	255

MESAS PIE CENTRAL DOBLE

PEDESTAL DOUBLE BASE TABLES |

TABLES PIED CENTRAL DOUBLE

Renoir Doble	256
Miró Doble	256
Tapies Doble	257
Max 120	257

MESAS PIE CENTRAL ALTO

HIGH PEDESTAL BASE TABLE |

TABLE PIED CENTRAL HAUTE

Renoir 110	258
Renoir 110 40x40	258
Miró 110	259

Miró 110 40x40	259
Tapies 110 ø40	260
Tapies 110	260
Max alto	260

MESAS 4 PATAS

4 LEG TABLES | TABLES 4 PIEDS

Sky	266
Octopus 60	267
Ares 80	268
Ares 140	268
Bali	270
Tahiti	270
Orlando 80	271
Orlando 140	271
Mamba	272
Shio	272
Cubic	272
Wood New Flash	273
Alegria	274
Montblanc	274
Ripoll	274
Kibo	275
Naxos	275
Paros	275
Berlin	276
Zurich	276
Marsella	277

London	277
Malta	280
Core	280
Raya	282
Raya 2	282
Raya 3	282
Ola	283
Ola 2	283
Ola 3	283
Beach Bar	284
Sky Lounge	284
Miami	286
Miami Auxiliar	286
Monaco mesa rattan	286
Octopus Bar	287
Esculapi	287
Banyoles	287

COMBINACIONES PIES | PEDESTAL COMBINATIONS | COMBINAISONS DE PIEDS

	Renoir	Miró	Tapies	Max	Neo
Pie central Pedestal base Pied				●	●
Pie central 40x40 Pedestal base 40x40 Pied 40x40	●	●	●		
Pie central Ø40 Pedestal base Ø40 Pied Ø40	●	●	●		
Pie central alto High pedestal base Pied central haut				●	
Pie central alto 40x40 High pedestal base 40x40 Pied central haut 40x40	●	●	●		
Pie central alto Ø40 High pedestal base Ø40 Pied central haut Ø40	●	●	●		
Pie central doble base rectangular Double central rectangular base pedestal Pied central double base rectangulaire	●	●	●		
Pie central doble Double central pedestal Pied central double				●	

RENOIR 40X40

Pie | Pedestal base | Pied



Pie central en acero inoxidable. Base 40x40. Para uso interior y exterior.

Pedestal base in stainless steel. Base of 40x40. For outdoor and indoor use.

Pied central en acier inoxydable. Base de 40x40 cm. Pour usage intérieur et extérieur.

● Inox | Inox | Inox

W 40 cm | W 15.75 in
L 40 cm | L 15.75 in
H 73 cm | H 28.74 in

STD units	Packaging dim. (cm)	M3/pack	NW units (kg)	Units Container 20'	Units Container 40'	Units Container HC	Units Truck 70m ³	Units Truck 100m ³
1	42x42x73 + 11x11x73	0,06	20	466	933	1.100	1.133	1.633

RENOIR Ø40

Pie | Pedestal base | Pied



Pie central en acero inoxidable. Base de Ø39 cm. Tubo de aluminio anodizado de Ø 60 mm con muesca antigiro. Altura 73 cm. Peso 7,80 kg. (Consultar tabla de combinaciones de pies y sobres en pág. 264). Para uso interior y exterior.

Pedestal base in stainless steel. Base of Ø39 cm. Ø60 mm anodized aluminium tube with non-turn notch. Height 73 cm. Weight 7.80 kg. (17.20 lb). (See combinations table for bases and table tops on p. 264). For outdoor and indoor use.

Pied central en acier inoxydable. Base de Ø 39 cm. Tube en aluminium anodisé en Ø60 mm avec encoche de fixation. Hauteur 73 cm. Poids 7,80 kg. (Voir le table combinaisons pour pieds et plateaux pag. 264). Pour usage intérieur et extérieur.

● Inox | Inox | Inox

Ø 39 cm | Ø 15.35 in
H 73 cm | H 28.74 in

W: ancho / width / largeur. L: largo / length / longueur
H: altura / height / hauteur. Hs: altura asiento / seat height / hauteur du siège. Ha: altura brazo / arm height / hauteur du bras
Ø: diámetro / diameter / diamètre.

STD units	Packaging dim. (cm)	M3/pack	NW units (kg)	Units Container 20'	Units Container 40'	Units Container HC	Units Truck 70m ³	Units Truck 100m ³
1	42x42x7 + 11x11x73	0,06	16	466	933	1.100	1.133	1.633

MIRÓ 40X40

Pie | Pedestal base | Pied



○ Blanco | White | Blanc

● Aluminio | Aluminio | Aluminio

W 40 cm	W 15.75 in
L 40 cm	L 15.75 in
H 73,5 cm	H 28.94 in

STD units	Packaging dim. (cm)	M3/ pack	NW units (kg)	Units Container 20'	Units Container 40'	Units Container HC	Units Truck 70m ³	Units Truck 100m ³
1	42x42x7	0,06	18	466	933	1.100	1.133	1.633
	+ 11x11x73							

Pie central para mesa de interior y exterior. Base de 40 x 40 cm en aluminio anodizado mate. Tubo de 80 x 80 mm de aluminio anodizado mate con muesca antigiro. Altura de 73,50 cm. Peso 11 kg. Con niveladores. (Consultar tabla de combinaciones de pies y sobres en pág. 264).

Pedestal base for indoor and outdoor table. Base of 40 x 40 cm in matt anodized aluminium. 80 x 80 mm matt anodized aluminium tube with non-turn notch. Height 73,50 cm. Weight 11 kg (24.25 lb). With levellers. (See combinations table for bases and table tops on p. 264).

Pied central pour table d'intérieur et d'extérieur. Base de 40 x 40 cm en aluminium anodisé mat. Tube de 80 x 80 mm en aluminium anodisé avec encoche de fixation. Hauteur 73,50 cm. Poids 11 kg. Avec niveleurs. (Voir le table combinaisons pour pieds et plateaux pag. 264)

MIRÓ Ø40

Pie | Pedestal base | Pied



● Aluminio | Aluminio | Aluminio

ø 39 cm	ø 15.35 in
H 73,50 cm	H 28.94 in

STD units	Packaging dim. (cm)	M3/ pack	NW units (kg)	Units Container 20'	Units Container 40'	Units Container HC	Units Truck 70m ³	Units Truck 100m ³
1	42x42x7	0,06	15	466	933	1.100	1.133	1.633
	+ 11x11x73							

Pie central para mesa de interior y exterior. Base de Ø39 cm en aluminio anodizado mate. Tubo de ø60 mm en aluminio anodizado mate con muesca antigiro. Altura de 73,50 cm. Peso 8,50 kg. Con niveladores. (Consultar tabla de combinaciones de pies y sobres en pág. 264).

Pedestal base for indoor and outdoor table. Base of Ø39 cm in matt anodized aluminium. Ø60 mm matt anodized aluminium tube with non-turn notch. Height 73.50 cm. Weight 8.50 kg. (18.74 lb). With levellers. (See combinations table for bases and table tops on p. 264).

Pied central pour table d'intérieur et extérieur. Base de Ø39 cm en aluminium anodisé mat. Tube de ø 60 mm en aluminium anodisé mat avec encoche de fixation. Hauteur 73,50 cm. Poids 8,50 kg. Avec niveleurs. (Voir le table combinaisons pour pieds et plateaux pag. 264).

TÀPIES 40X40

Pie | Pedestal base | Pied



Pie central de hierro fundido pintado en color negro, para mesa de uso interior. Columna de 80 x 80 mm con muesca antigiro. Base de 40 x 40 cm. Peso neto 20 kg. (Consultar tabla de combinaciones de pies y sobres en pág. 264).

Painted cast iron pedestal base table in black, for indoor use. 80 x 80 mm tube. Non-turn notch. Base of 40 x 40 cm. Net weight 20 kg (8.7 lb). (See Table combination for pedestral bases and table tops on p. 264).

Pied guéridon en font de fer peint en noir, pour table intérieur. Tube de 80x 80 mm avec encoche de fixation. Base de 40 x 40 cm. Poids net 20 Kg. (Voir le tableau de combinaison pour pieds central et planches pag. 264).

L 40 cm	L 15.75 in
W 40 cm	W 15.75 in
H 71 cm	H 27.95 in

○ Blanco | White | Blanc

● Negro | Black | Noir

STD units	Packaging dim. (cm)	M3/ pack	NW units (kg)	Units Container 20'	Units Container 40'	Units Container HC	Units Truck 70m ³	Units Truck 100m ³
1	42x42x7	0,06	20	466	933	1.100	1.133	1.633
	+ 11x11x73							

TAPIES Ø40

Pie | Pedestal base | Pied



Pie central de hierro fundido pintado en color negro o blanco. Base de Ø40 cm. Mesa de uso interior (Consultar tabla de combinaciones 265).

Painted cast iron pedestal base table in black or in white. Base of Ø40 cm. For indoor use. (See table combination for pedestral bases and table tops on p. 265).

Pied central en fer fondu peint de couleur noire ou blanche. Base de Ø40 cm. Table pour usage intérieur. (Consultez le tableau de combinaisons de pieds et plateau en page 265).

Ø 40 cm	Ø 15.75 in
H 70 cm	H 27.55 in

○ Blanco | White | Blanc

● Negro | Black | Noir

STD units	Packaging dim. (cm)	M3/ pack	NW units (kg)	Units Container 20'	Units Container 40'	Units Container HC	Units Truck 70m ³	Units Truck 100m ³
1	41,5x41,5x4,5	0,01	9,7	1.818	2.136	2.136	-	-
	+ 73x8,5x8,5							

MAX

Pie | Pedestal base | Pied



Pie central para mesa de interior y exterior, en fundición de aluminio pintado brillante o mate. Tubo de aluminio anodizado \varnothing 60 x 2 mm de grosor, con muesca anti-giro. Contrapeso de acero de 4,50 kg. Con reguladores en las 4 patas. (Consultar tabla de combinaciones de pies y sobres en pág. 265).

Pedestal base for indoor and outdoor table. Cast aluminium. Shiny or matt painted finish. Anodized aluminium tube, \varnothing 60 x 2 mm thick. Non-turn notch. Steel counterweight 4.5 kg (9.90 lb). With regulators in all 4 legs. (See Table combination for pedestral bases and table tops on p. 265).

Pied central pour table, intérieur ou extérieur, en fonte en aluminium peint brillant ou mat. Tube en aluminium anodisé \varnothing 60 x 2 mm de grosueur. Encoche antigiratoire. Contrepoids en acier de 4,50 kg. Avec régulateurs aux 4 pieds (Voir le tableau de combinaison pour pieds central et planches pag. 265).

Atención: No recomendamos la versión en acabado brillante para ambientes salinos | Attention: Shiny painted finish version not recommended for saline environments | Attention: Nous ne recommandons pas la version brillante pour les environnements salins.

● Brillante | Shiny | Brillant

● Mate | Matt | Mat

W 53 cm | W 20.87 in
L 53 cm | L 20.87 in
H 71 cm | H 27.95 in

STD units	Packaging dim. (cm)	M3/ pack	NW units (kg)	Units Container 20'	Units Container 40'	Units Container HC	Units Truck 70m ³	Units Truck 100m ³
1	54x54x10 + 10x10x73	0,03	8,2	850	1.700	-	-	-

NEO

Pie | Pedestal base | Pied



Pie central para exterior. Estructura tubular de aluminio anodizado brillante. (Consultar tabla de combinaciones en la página 264)

Central pedestal for outdoor use. Tubular structure of anodized aluminium, shiny finish. (See Table combination p. 264)

Pied central pour extérieur. Structure tubulaire en aluminium anodisé brillant. (Voir couleurs pag. 264).

○ Blanco | White | Blanc

● Aluminio | Aluminio | Aluminio

W 68 cm | W 26.77 in
L 68 cm | L 26.77 in
H 71 cm | H 27.95 in

STD units	Packaging dim. (cm)	M3/ pack	NW units (kg)	Units Container 20'	Units Container 40'	Units Container HC	Units Truck 70m ³	Units Truck 100m ³
1	51x51x14 + 10x10x73	0,04	8,21	933	-	-	-	-

IBIZA S

Pie | Pedestal | Pied



- Gris Oscuro | Dark Grey | Gris Foncé
- Chocolate | Chocolate | Chocolat

Siesta
exclusive

W 58 cm | W 22.83 in
L 58 cm | L 22.83 in
H 72,5 cm | H 28.54 in

STD units	Packaging dim. (cm)	M3/ pack	NW units (kg)	Units Container 20'	Units Container 40'	Units Container HC	Units Truck 70m³	Units Truck 100m³
1	73x58x36	0,152	8,3	192	448	448	-	576

Estructura de ratán de 80 cm de longitud para combinarlo con tablero compacto de HPL. Para mesa tanto de uso interior como exterior. (Consultar la tabla de combinaciones en la página 265).

Rattan structure of 80 cm length to combine with HPL compact laminate tops. For indoor and outdoor use. (See Table combination p. 265).

Structure de rotin de 80 cm de longueur pour combiner avec le plateau compact en HPL. Pour table autant à usage intérieur qu'extérieur. (Consultez le tableau des combinaisons pag. 265).

IBIZA M

Pie | Pedestal | Pied



W 118 cm | W 46.46 in
L 58 cm | L 22.83 in
H 72,5 cm | H 28.54 in

- Gris Oscuro | Dark Grey | Gris Foncé
- Chocolate | Chocolate | Chocolat

Siesta
exclusive

STD units	Packaging dim. (cm)	M3/ pack	NW units (kg)	Units Container 20'	Units Container 40'	Units Container HC	Units Truck 70m³	Units Truck 100m³
1	73x58x36	0,15	10,3	192	448	448	-	576

Estructura de ratán de 140 cm de longitud para combinarlo con tablero compacto de HPL. Para mesa tanto de uso interior como exterior. (Consultar la tabla de combinaciones en la página 265).

Rattan structure of 140 cm length to combine with HPL compact laminate tops. For indoor and outdoor use.. (See Table combination p. 265).

Structure de rotin de 140 cm de longueur pour combiner avec le plateau compact en HPL. Pour table autant à usage intérieur qu'extérieur. (Consultez le tableau des combinaisons pag. 265).



RENOIR DOBLE

Pie | Pedestal base | Pied



● Inox | Inox | Inox

W 70 cm | W 27.56 in
L 40 cm | L 15.75 in
H 73 cm | H 28.74 in

STD units	Packaging dim. (cm)	M3/pack	NW units (kg)	Units Container 20'	Units Container 40'	Units Container HC	Units Truck 70m ³	Units Truck 100m ³
1	42x84x7	0,06	32	466	933	1.100	1.133	1.633
+ 11x11x73 (2)								

Pie central doble en acero inoxidable. Base de 72 x 40 cm. Tubos de aluminio anodizado de 80 x 80 mm con muesca antigiro. Altura de 73 cm. Peso 19,50 kg. (Consultar tabla de combinaciones de pies y sobres en pág. 264). Para uso interior y exterior.

Double pedestal in stainless steel. Base of 72 x 40 cm. 80 x 80 mm anodized aluminium tube with non-turn notch. Height 73 cm. Weight 19,50 kg (42.99 lb). (See Combinations table for bases and table tops on p.264). For outdoor and indoor use.

Double pied central en acier inoxydable. Base de 72 x 40 cm. Tube en aluminium anodisé de 80 x 80 mm avec encoche de fixation. Pour usage intérieur et extérieur. Hauteur 73 cm. Poids 19,50 kg. (Voir le tableau de combinaison pour pieds et plateaux pag. 264). Pour usage intérieur et extérieur.

MIRÓ DOBLE

Pie | Pedestal base | Pied

● Aluminio | Aluminio | Aluminio

W 40 cm | W 15.75 in
L 40 cm | L 15.75 in
H 73,5 cm | H 28.94 in



Pie central doble para mesa de interior y exterior. Base de 72x40cm en aluminio anodizado mate. Tubo de 80 x 80 mm en aluminio anodizado mate con muesca antigiro. Altura de 73,50 cm. Peso 20kg. Con niveladores. (Consultar tabla de combinaciones de pies y sobres en pág. 264).

Double pedestal base for indoor and outdoor table. Base of 72 x 40 cm in matt anodized aluminium. 80 x 80 mm matt anodized aluminium tube with non-turn notch. Height 73,50 cm. Weight 20 kg (44.09 lb). With levellers. (See combinations table for bases and table tops on p. 264).

Double pied central pour table d'intérieur et d'extérieur. Base de 72 x 40 cm en aluminium anodisé mat. Tube de 80 x 80 mm en aluminium anodisé mat avec encoche de fixation. Hauteur 73,50 cm. Poids 20 kg. Avec niveleurs. (Voir le table combinaisons pour pieds et plateaux pag. 264).

W: ancho / width / largeur. L: largo / length / longueur
H: altura / height / hauteur. Hs: altura asiento / seat height / hauteur du siège. Ha: altura brazo / arm height / hauteur du bras
Ø: diámetro / diameter / diamètre.

STD units	Packaging dim. (cm)	M3/pack	NW units (kg)	Units Container 20'	Units Container 40'	Units Container HC	Units Truck 70m ³	Units Truck 100m ³
1	42x84x7	0,06	18	466	933	1.100	1.133	1.633
+ 22x11x73 (2)								

TÀPIES DOBLE

Pie | Pedestal base | Pied



Pie central de hierro fundido pintado en color negro o blanco. Mesa de uso interior (Consultar tabla de combinaciones 264)

Painted cast iron pedestal base table in black or in white. For indoor use. (See table combination for pedestral bases and table tops on p.264)

Pied central en fer fondu peint de couleur noire ou blanche. Table pour usage intérieur. (Consultez le tableau de combinaisons de pieds et plateau en page 264).

○ Blanco | White | Blanc

● Negro | Black | Noir

L 70 cm	L 27.55 in
W 40 cm	W 15.75 in
H 71 cm	H 27.95 in

STD units	Packaging dim. (cm)	M3/ pack	NW units (kg)	Units Container 20'	Units Container 40'	Units Container HC	Units Truck 70m ³	Units Truck 100m ³
1	71,5x41,5x4,5 +73x9,3x9,3 (2)	0,02	24,3	772	907	907	-	-

W: ancho / width / largeur. L: largo / length / longueur
H: altura / height / hauteur. Hs: altura asiento / seat height / hauteur du siège. Ha: altura brazo / arm height / hauteur du bras
Ø: diámetro / diameter / diamètre.

MAX 120

Pie | Pedestal base | Pied



Pie central doble para mesa interior y exterior, en fundición de aluminio pintado brillante o mate. Tubo de aluminio anodizado de Ø 60 x 2 mm de grosor, con muesca anti-giro Contrapeso de acero: 4,50 kg. Con reguladores en las 4 patas. (Consultar tabla de combinaciones de pies y sobres en pág. 265).

Double pedestal base table for indoor and outdoor use, in shiny or matt polished cast aluminium. Anodized aluminium tube of Ø 60 x 2 mm thickness. Non-turn notch. Steel counterweight: 4.5 kg (9.90 lb). With regulators in all 4 legs. (See Table combination for pedestral bases and table tops on p. 265).

Pied central pour table intérieur ou extérieur, en fonte en aluminium poli brillant ou mat. Tube en aluminium anodisé Ø 60 x 2 mm de grosseur. Encoche anti giratoire. Contrepoids en acier: 4,50 kg. Avec régulateurs aux 4 pieds. (Voir le tableau de combinaison pour pieds central et planches pag. 265).

● Brillante | Shiny | Brillant

● Mate | Matt | Mat

W 79 cm	W 31.10 in
L 43 cm	L 16.93 in
H 71 cm	H 27.95 in

STD units	Packaging dim. (cm)	M3/ pack	NW units (kg)	Units Container 20'	Units Container 40'	Units Container HC	Units Truck 70m ³	Units Truck 100m ³
1	80x62x11 + 10x10x73	0,54	10,8	516	1.032	-	-	-

RENOIR 110

Pie | Pedestal base | Pied



Pie central alto en acero inoxidable. Base de \varnothing 39 cm. Tubo de aluminio anodizado de \varnothing 60 mm con muesca antigiro. Altura de 111 cm. Peso 8 kg. (Consultar tabla de combinaciones de pies y sobres en pág. 264). Para uso interior y exterior.

High pedestal base in stainless steel. Base of \varnothing 39 cm. \varnothing 60 mm anodized aluminium tube with non-turn notch. Height 111 cm. Weight 8 kg (17.64 lb). (See combinations table for bases and table tops on p. 264). For outdoor and indoor use.

Pied central haut en acier inoxydable. Base de tube de \varnothing 39 cm. Tube en aluminium anodisé de \varnothing 60mm avec encoche de fixation. Hauteur 111 cm. Poids 8 kg. (Voir le table combinaisons pour pieds et plateaux pag. 264). Pour usage intérieur et extérieur.

● Inox | Inox | Inox

\varnothing 39 cm | \varnothing 15.35 in
H 111 cm | H 43.70 in

STD units	Packaging dim. (cm)	M3/ pack	NW units (kg)	Units Container 20'	Units Container 40'	Units Container HC	Units Truck 70m ³	Units Truck 100m ³
1	42x42x7 + 10x10x110	0,06	20	466	933	1.100	1.133	1.633

RENOIR 110 40X40

Pie | Pedestal base | Pied



Pie central alto en acero inoxidable. Base de 40x40 cm. Tubo de aluminio anodizado. Altura de 111cm. (Consultar tabla de combinaciones de pies y sobres en pág. 264). Para uso interior y exterior.

High pedestal base in stainless steel. Base of 40 x 40 cm. Anodized aluminium tube. Height 111 cm. See combinations table for bases and table tops on p. 264). For outdoor and indoor use.

Pied central haut en acier inoxydable. Base tube de 40 x 40 cm. Tube en aluminium anodisé. Hauteur 111 cm. (Voir le table combinaisons pour pieds et plateaux pag. 264) Pour usage intérieur et extérieur.

● Inox | Inox | Inox

W 40 cm | \varnothing 15.75 in
L 40 cm | L 15.75 in
H 111 cm | H 43.70 in

STD units	Packaging dim. (cm)	M3/ pack	NW units (kg)	Units Container 20'	Units Container 40'	Units Container HC	Units Truck 70m ³	Units Truck 100m ³
1	42x42x7 + 10x10x110	0,06	20	466	933	1.100	1.133	1.633

W: ancho / width / largeur. L: largo / length / longueur

H: altura / height / hauteur. Hs: altura asiento / seat height / hauteur du siège. Ha: altura brazo / arm height / hauteur du bras

\varnothing : diámetro / diameter / diamètre.

MIRÓ 110

Pie | Pedestal base | Pied



Pie central alto para interior y exterior en aluminio anodizado mate con muestra antigiro. Peso 18kg. Con niveladores. Consultar tabla de combinaciones de pies y sobres en pág. 264)

High pedestal base for indoor and outdoor made of anodized aluminium with non-torch notch. Weight 18kg. With levellers. (See combinations table for bases and table tops on p. 264)

Pied central haut por intérieur et extérieur en aluminium anodisé mat avec encoche de fixation. Poids 18kg. Avec niveleurs. (Voir le table combinaciones pour pieds et plateaux pag. 264)

● Aluminio | Aluminio | Aluminio

∅ 39 cm | ∅ 111.50 in
H 15,35 cm | H 43.89 in

STD units	Packaging dim. (cm)	M3/pack	NW units (kg)	Units Container 20'	Units Container 40'	Units Container HC	Units Truck 70m³	Units Truck 100m³
1	42x42x7	0,06	18	466	933	1.100	1.133	1.633
+ 110x10x110								

MIRÓ 110 40X40

Pie | Pedestal base | Pied



Pie central para mesa de interior y exterior. Base de 40x40 cm en aluminio anodizado mate. Altura 110 cm. Con niveladores. (Consultar tabla de combinaciones de pies y sobres en pág. 264)

Pedestal base for indoor and outdoor table. Base of 40x40 cm in matt anodized aluminium. Height 110 cm. With levellers. (See combinations table for bases and table tops on p. 264)

Pied central pour table d'intérieur et d'extérieur. Base de 40x40 cm en aluminium anodisé mat. Hauteur 110 cm. Avec niveleurs. (Voir le table combinaisons pour pieds et plateaux pag. 264)

○ Blanco | White | Blanc

● Inox | Inox | Inox

W 40 cm | W 15.75 in
L 40 cm | L 15.75 in
H 110 cm | H 43.30 in

STD units	Packaging dim. (cm)	M3/pack	NW units (kg)	Units Container 20'	Units Container 40'	Units Container HC	Units Truck 70m³	Units Truck 100m³
1	42x42x7	0,06	18	466	933	1.100	1.133	1.633
+ 110x10x110								

W: ancho / width / largeur. L: largo / length / longueur
H: altura / height / hauteur. Hs: altura asiento / seat height / hauteur du siège. Ha: altura brazo / arm height / hauteur du bras
∅: diámetro / diameter / diamètre.

TAPIES 110 Ø40

Pie | Pedestal base | Pied



Pie central alto de hierro fundido pintado en color negro o blanco, para mesa de uso interior (Consultar tabla de combinaciones 265).

High iron pedestal base table in black or white. For indoor use. (See table combination for pedestral bases and table tops on p. 265).

Pied central haut en fer fondu peint de couleur noire ou blanche. Table pour usage intérieur. (Consultez le tableau de combinaisons de pieds et plateau en page 265).

Blanco | White | Blanc

ø 40 cm | ø 15.75 in

Negro | Black | Noir

H 106 cm | H 41.73 in

STD units	Packaging dim. (cm)	M3/ pack	NW units (kg)	Units Container 20'	Units Container 40'	Units Container HC	Units Truck 70m ³	Units Truck 100m ³
1	41,5x41,5x4,5 + 109x8,5x8,5	0,016	11	1.626	1.910	1.910	-	-

TAPIES 110

Pie | Pedestal base | Pied



Pie central alto de hierro fundido pintado en color negro o blanco, para mesa de uso interior (Consultar tabla de combinaciones 265).

High iron pedestal base table in black or white. For indoor use. (See table combination for pedestral bases and table tops on p. 265).

Pied central haut en fer fondu peint de couleur noire ou blanche. Table pour usage intérieur. (Consultez le tableau de combinaisons de pieds et plateau en page 265).

Blanco | White | Blanc

Negro | Black | Noir

W: ancho / width / largeur. L: largo / length / longueur

H: altura / height / hauteur. Hs: altura asiento / seat height / hauteur du siège. Ha: altura brazo / arm height / hauteur du bras

Ø: diámetro / diameter / diamètre.

W 40 cm

W 15.75 in

L 40 cm

L 15.75 in

H 106 cm

H 41.73 in

STD units	Packaging dim. (cm)	M3/ pack	NW units (kg)	Units Container 20'	Units Container 40'	Units Container HC	Units Truck 70m ³	Units Truck 100m ³
1	41,5x41,5x4,5 + 109x9,3x9,3	0,017	13,9	1.315	1.546	1.546	-	-

MAX ALTO

Pie | Pedestal base | Pied



Pie central alto para mesa de interior y exterior, en fundición de aluminio brillante o pintado mate. Tubo de aluminio anodizado mate ø 60 x 2 mm de grosor, con muesca anti-giro. Contrapeso de acero: 4,50 kg. Con reguladores en las 4 patas. (Consultar tabla de combinaciones de pies y sobres en pág. 265).

Pedestal base for high table for indoor and outdoor use, in shiny cast aluminium or matt painted. Anodized aluminium tube, matt finish, ø 60 x 2 mm thickness, with non-turn notch. Steel counterweight: 4.5 kg (9.90 lb). With regulators in all 4 legs. (See Table combination for pedestral bases and table tops on p. 265).

Pied guéridon haut pour table, intérieur ou extérieur, en coulage en aluminium brillant ou peint mat. Tube en aluminium anodisé, ø 60 x 2 mm de grosseur. Encoche anti giratoire. Contrepoids en acier: 4,50 kg. Avec régulateurs aux 4 pieds. (Voir le tableau de combinaison pour pieds central et planches pag. 265).

W 53 cm

W 20.86 in

L 53 cm

L 20.86 in

H 109 cm

H 42.91 in

STD units	Packaging dim. (cm)	M3/ pack	NW units (kg)	Units Container 20'	Units Container 40'	Units Container HC	Units Truck 70m ³	Units Truck 100m ³
1	53x53x9 8x8x110	0,02 + 0,01	8,7	750	1500	-	-	-

Brillante | Shiny | Brillant

Mate | Matt | Mat

TABLERO COMPACTO FENÓLICO

HPL TABLE TOP

PLATEAU RÉSINE PHÉNOLIQUE

El compacto fenólico es un laminado de alta presión (HPL). Su composición consiste en capas de papel aglutinado con resinas termoestables de melamina-formaldehído en su superficie y de fenol-formaldehído en su interior. Todo ello es prensado a alta presión (≥ 7 MPa) y alta temperatura ($\geq 120^\circ\text{C}$), dando como resultado uno de los materiales más versátiles por su apariencia, estética, resistencia y durabilidad.

Su extraordinaria superficie está constituida por una hoja impregnada con resina de melamina-formaldehído, que es la que aporta el diseño. Por encima de este diseño decorativo lleva una hoja adicional (overlay), impregnada también en resina melamínica, que le aporta gran resistencia al rayado y la abrasión. Finalmente, el núcleo central, compuesto de papel kraft impregnado en resina fenólica, le dotan de gran resistencia al impacto. Tanto el overlay como el núcleo central de resina fenólica, son los dos elementos diferenciadores del laminado HPL.

El laminado HPL posee la cualidad de ser resistente al calor, al rayado, a la abrasión, impermeable e inerte debido a su superficie no porosa, lo cual lo hace apto para uso interior y exterior e ideal para uso contract.

HPL is a high pressure laminate (HPL). Its composition is bonded paper layers with thermosetting resins, melamine-formaldehyde on its surface and phenol-formaldehyde inside. All this is pressed at high pressure (≥ 7 MPa) and high temperature ($\geq 120^\circ\text{C}$), resulting in one of the most versatile materials in appearance, aesthetics, strength and durability.

Its extraordinary surface is constituted by a sheet impregnated with melamine-formaldehyde resin, which gives it a unique design. Above this decorative design it has an additional sheet (overlay) that's also impregnated with melamine resin, which makes it highly resistant to scratches and abrasion. Finally, the central core, consisting of kraft paper impregnated with phenolic resin, provide it with high impact resistance. Both the overlay and the core of phenolic resin are the two distinguishing features of HPL.

The HPL has the peculiarity of being resistant to heat, scratch, abrasion, waterproof and inert due to its non-porous surface, making it suitable for indoor and outdoor use and ideal for contract use.

La résine phénolique est un stratifié compact (HPL) de haute pression. Sa composition est constituée de couches de papier avec des résines thermodurcissables, des résines mélamine-formaldéhyde, sur sa surface et de phénol-formaldéhyde à l'intérieur. Tout cela est pressé à haute pression (≥ 7 MPa) et haute température ($\geq 120^\circ\text{C}$), résultant un des matériaux les plus polyvalents pour son apparence, esthétique, solidité et durabilité.

Sa surface extraordinaire est constituée par une feuille imprégnée de résine mélamine-formaldéhyde, qui elle même apporte son dessin. Au-dessus de ce dessin décoratif, s'ajoute une feuille supplémentaire (overlay) imprégnée de résine mélamine également, ce qui donne une haute résistance les rayures et l'abrasion. Enfin, le noyau central, composé de papier kraft imprégné de résine phénolique, lui permet une résistance aux chocs élevée. Autant la superposition comme le noyau de résine phénolique sont les deux traits distinctifs de HPL.

Le HPL a la qualité d'être résistant à la chaleur, aux égratignures, à l'abrasion, imperméable à l'eau et inerte en raison de sa surface non poreuse, ce qui convient pour usage intérieur et extérieur et idéal pour une utilisation contrat.

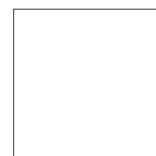

Blanco | White | Blanc



Negro | Black | Noir

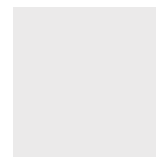

Plata | Silver | Argent

Ø 60 cm H 1 cm	Ø 23.62 in H 0.40 in	Ø 70 cm H 1 cm	Ø 27.56 in H 0.40 in
Ø 80 cm H 77,7 cm	Ø 31.49 in H 0.40 in	L60 cm W 60 cm H 1 cm	L 23.62 in W 23.62 in H 0.40 in
L 70 cm W 70 cm H 1 cm	L 27.56 in W 27.56 in H 0.40 in	L 80 cm W 80 cm H 1 cm	L 31.49 in W 31.49 in H 0.40 in
L 90 cm W 90 cm H 1 cm	L 35.43 in W 35.43 in H 0.40 in	L 120 cm W 80 cm H 1 cm	L 47.24 in W 31.49 in H 0.40 in
L 180 cm W 90 cm H 1 cm	L 70.87 in W 35.43 in H 0.40 in	L 200 cm W 90 cm H 1 cm	L 78.74 in W 35.43 in H 0.40 in



Madera lavada | Washed Wood | Bois Delavé



Roble Ceniza | Ashen Oak | Chêne Cendré



Roble Natural | Natural Oak | Chêne Naturel

L 70 cm W 60 cm H 1 cm	L 27.56 in W 23.62 in H 0.40 in	L 70 cm W 70 cm H 1 cm	L 27.56 in W 27.56 in H 0.40 in
L 80 cm W 80 cm H 1 cm	L 31.49 in W 31.49 in H 0.40 in	L 90 cm W 90 cm H 1 cm	L 35.43 in W 35.43 in H 0.40 in
L 120 cm W 80 cm H 1 cm	L 47.24 in W 31.49 in H 0.40 in	L 180 cm W 90 cm H 1 cm	L 70.87 in W 35.43 in H 0.40 in
Ø 80 cm H 1 cm	Ø 34.49 in H 0.40 in		

Cualquier otro color bajo pedido y plazo de entrega. Consultar Departamento Comercial. Any other colour upon request, delivery time varies. Ask the Sales Department. N'importe quelle couleur sur commande et délai de livraison. Consulter le Département Commercial.

TABLERO WERZALIT®

WERZALIT® TABLE TOP

PLATEAU WERZALIT®

Los tableros Werzalit se fabrican según un procedimiento patentado especialmente para su uso en interiores y exteriores. Debido al núcleo del material altamente triturado y prensado y con la superficie prensada homogéneamente con materiales derivados de la madera, los tableros Werzalit logran una larga vida útil, son sumamente sólidos y totalmente resistentes a la intemperie. No se recomienda exponer el werzalit en colores oscuros directamente al sol para evitar que se curve o deforme por efecto de la acumulación de calor.

Werzalit table tops are manufactured specially for use inside and outside using a patented procedure. Due to its high density material core manufactured from naturally grown wood and the surface pressed homogeneously with the wood material, Werzalit table tops are durable, hard-wearing and completely weatherproof. We do not recommend to expose dark werzalit table tops to the sun in order to avoid curving or deforming through the effect of heat accumulation.

Les plateaux de tables Werzalit sont fabriqués selon un procédé breveté en particulier pour un usage intérieur comme extérieur. Grâce à son noyau de haute densité avec particules de bois compressées et homogènes, les plateaux de tables Werzalit sont durables, robustes et absolument résistant aux intempéries. Nous recommandons de ne pas exposer les plateaux Werzalit foncés directement au soleil afin d'éviter qu'ils se courbent et se déforment par l'accumulation de chaleur.



Cualquier otro color bajo pedido y plazo de entrega. Consultar Departamento Comercial.

Any other colour upon request, delivery time varies. Ask the Sales Department.

N'importe quelle couleur sur commande et délai de livraison. Consulter le Département Commercial.



Otros colores o medidas, consultar con el departamento comercial.

For other colours or sizes please consult commercial department.

Plusieurs couleurs, consulter le département commercial.



Blanco | White | Blanc

Ø 60 cm	Ø 23.62 in	W 60 cm L 60 cm	W 23.62 in L 23.62 in
W 70 cm L 70 cm	W 27.56 in L 27.56 in	W 80 cm L 80 cm	W 31.49 in L 31.49 in
W 90 cm L 90 cm	W 35.43 in L 35.43 in	W 120 cm L 80 cm	W 47.24 in L 31.49 in
W 56,1 cm L 56,4 cm H 77,7 cm	W 22.09 in L 22.20 in H 30.59 in	W 56,1 cm L 56,4 cm H 77,7 cm	W 22.09 in L 22.20 in H 30.59 in



Stratos | Stratos | Stratos

Ø 60 cm	Ø 23.62 in	W 70 cm L 70 cm	W 27.56 in L 27.56 in
W 80 cm L 80 cm	W 31.49 in L 31.49 in	W 120 cm L 80 cm	W 47.24 in L 31.49 in



Wengé | Wenge | Wenge

Ø 60 cm	Ø 23.62 in	W 70 cm L 70 cm	W 27.56 in L 27.56 in
W 80 cm L 80 cm	W 31.49 in L 31.49 in	W 120 cm L 80 cm	W 47.24 in L 31.49 in

TABLERO DUROLIGHT

DUROLIGHT TABLE TOP

PLATEAU DUROLIGHT

Los tableros DUROLight son por su resistencia una opción idónea para el uso interior, y perfectamente combinable con la gama de sillas de Resol Contract. Están realizados de melamina con una imprimación de resina en la superficie que los protege de arañazos y de altas temperaturas (hasta 180°C). Los cantos están sellados con ABS para garantizar un acabado perfecto y resistente (Pruebas realizadas demuestran que son necesarios más de 1.5 Newton para conseguir arañar la superficie y 350 rotaciones para que se experimente desgaste.) Disponibles en color wengé, pino vintage y blanco.

The DUROLight tabletops are an ideal option for indoor use due to their resistance, and perfectly combinable with the range of Resol Contract. They are made of melamine with a resin coating on the surface, which protects them from scratches and high temperatures (up to 180°C). The edges are ABS sealed in order to guarantee a perfect and resistant finish. (Tests carried out showed that more than 1.5 Newton is necessary to achieve scratching the surface and 350 rotations in order to show wear.) Available in the colours wenge, vintage pine and white.

La résistance des planches DUROLight en fait l'option idéale pour un usage intérieur, et pouvant être parfaitement combinées avec la gamme de Resol Contract. Ils sont fabriqués en mélamine avec une couche de résine en surface protégeant des rayures et des hautes températures (jusqu'à 180°C) Les bords sont collés par ABS afin de garantir une finition parfaite et résistante. (Les tests réalisés démontrent qu'il faut plus de 1,5 Newton pour parvenir à rayer la surface et 350 rotations pour que l'usure commence.) Couleurs disponibles: wengé, pin vintage et blanc.

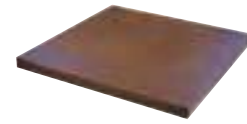

Standard
Wengé | Wenge | Wenge

W 68 cm	W 26.77 in	W 80 cm	W 31.49 in
L 68 cm	L 26.77 in	L 80 cm	L 31.49 in
H 5 cm	H 1.97 in	H 5 cm	H 1.97 in



Standard
Blanco | White | Blanc

W 68 cm	W 26.77 in	W 80 cm	W 31.49 in
L 68 cm	L 26.77 in	L 80 cm	L 31.49 in
H 5 cm	H 1.97 in	H 5 cm	H 1.97 in



Standard
Pino Vintage | Vintage Pine | Pin Vintage

W 68 cm	W 26.77 in	W 80 cm	W 31.49 in
L 68 cm	L 26.77 in	L 80 cm	L 31.49 in
H 5 cm	H 1.97 in	H 5 cm	H 1.97 in



Cualquier otro color bajo pedido y plazo de entrega. Consultar Departamento Comercial.

Any other colour upon request, delivery time varies. Ask the Sales Department.

N'importe quelle couleur sur commande et délai de livraison. Consulter le Département Commercial.



Standard: Acabado de Superficie de Melamina Decorativa + Revestimiento Protector Transparente.

① Standard: Decorative Melamine Surface Finish + Extra Transparent Overlay.

Standard: Finition de surface de mélamine décorative + revêtement protecteur transparent.

Aglomerado de 8 mm.

② 8 mm Chipboard layer.

Agglomérat de 8 mm.

Núcleo Interno Alveolar.

③ Internal Honeycomb core.

Noyau interne alvéolaire.

Canto de Unión de 3 mm de ABS inyectado.

④ 3 mm Support Edge of foamed ABS.

Bord d'union de 3 mm en ABS injecté.

Canto Decorativo de 2 mm de ABS.

⑤ 2 mm ABS Decor Edge.

Bord décoratif de 2 mm en ABS.

COMBINACIONES DE MESAS | TABLE COMBINATIONS | COMBINAISONS DE TABLES

Material / Material / Material	Medidas / Measurements / Mesures	Neo	Renoir 40x40	Renoir Doble	Renoir Ø40	Renoir 110	Renoir 110 40 x 40	Miró 40x40	Miró Doble	Miró Ø40	Miró 110	Miró 110 40 x 40	Tapica 40x40	Tapica doble
HPL	Ø 80	•	•	•	•	•	•	•	•	•	•	•	•	•
	Ø 80	•	•	•	•	•	•	•	•	•	•	•	•	•
	70 x 70	•	•	•	•	•	•	•	•	•	•	•	•	•
	120 x 90	•	•	•	•	•	•	•	•	•	•	•	•	•
HPL MADERA HPL Wood HPL bois	70 x 60	•	•	•	•	•	•	•	•	•	•	•	•	•
	80 x 80	•	•	•	•	•	•	•	•	•	•	•	•	•
	80 x 80	•	•	•	•	•	•	•	•	•	•	•	•	•
Roble natural natural oak chêne naturel	60 x 60	•	•	•	•	•	•	•	•	•	•	•	•	•
	80 x 80	•	•	•	•	•	•	•	•	•	•	•	•	•
Roble ceniza ashen oak chêne cendré	60 x 60	•	•	•	•	•	•	•	•	•	•	•	•	•
Madera lavada Washed wood Bois lavé	60 x 60	•	•	•	•	•	•	•	•	•	•	•	•	•
NERZALIT	60 x 60	•	•	•	•	•	•	•	•	•	•	•	•	•
	80 x 80	•	•	•	•	•	•	•	•	•	•	•	•	•
DUKULIGHT	80 x 80	•	•	•	•	•	•	•	•	•	•	•	•	•
	80 x 80	•	•	•	•	•	•	•	•	•	•	•	•	•
INOX REFLSADO	Ø 60	•	•	•	•	•	•	•	•	•	•	•	•	•
	60 x 60	•	•	•	•	•	•	•	•	•	•	•	•	•
	80 x 80	•	•	•	•	•	•	•	•	•	•	•	•	•

Las combinaciones disponibles han sido revisadas y aprobadas por el departamento técnico. Para productos destinados a zonas de alta salinidad consultar previamente con departamento comercial / The combinations available have been reviewed and approved by the technical department. For products destined to high salinity areas, consult previously with the commercial department / Les combinaisons disponibles ont été examinées et approuvées par le département technique. Produits destinés aux zones de haute salinité consulter à l'avance au dépt. commercial

COMBINACIONES DE MESAS | TABLE COMBINATIONS | COMBINAISONS DE TABLES

Material Material Matériel	Medidas Measurements Mesures	Tàpies Ø40	Tàpies 110 Ø40	Tàpies 110	Max	Max 120	Max Alto	Raya	Ola	Ibiza S	Ibiza M	Core
----------------------------------	------------------------------------	---------------	-------------------	---------------	-----	------------	----------	------	-----	---------	---------	------

HPL



Ø 60	●	●		●		●		●				
Ø 70	●			●				●				
Ø 80	●			●				●				
60 x 60			●	●				●				
70 x 70				●				●		●		●
80 x 80				●				●		●		
120 x 80					●						●	

HPL MADERA

HPL Wood
HPL bois

Roble natural
natural oak
chêne naturel

Roble ceniza
ashen oak
chêne cendré

Madera lavada
Washed wood
Bois delavé



Ø 80	●			●				●				
70 x 60				●								
70 x 70				●				●		●		●
80 x 80				●				●		●		
120 x 80					●						●	

WERZALIT



Ø 60	●	●		●		●		●				
60 x 60			●	●				●				
70 x 70				●				●		●		
80 x 80				●				●		●		
120 x 80					●						●	

DUROLIGHT



68 x 68				●								
80 x 80				●								

INOX REPULSADO



Ø 60				●		●		●				
Ø 70				●				●				
60 x 60				●				●				
70 x 70				●				●				
80 x 80				●				●				

Las combinaciones disponibles han sido revisadas y aprobadas por el departamento técnico. Para productos destinados a zonas de alta salinidad consultar previamente con departamento comercial / The combinations available have been reviewed and approved by the technical department. Ask previously sales dept. for using our products in high salinity areas / Les combinaisons disponibles ont été examinées et approuvées par le département technique. Produits destinés aux zones de haute salinité consulter à l'avance au dép. commercial.

SKY

Mesa | Table | Table



CATAS Siesta

W: ancho / width / largeur. **L:** largo / length / longueur
H: altura / height / hauteur. **Hs:** altura asiento / seat height /
 hauteur du siège. **Ha:** altura brazo / arm height / hauteur du bras
 Ø: diámetro / diameter / diamètre.

La mesa Sky está fabricada en polipropileno resistente a la intemperie. Con protección UV, lo que asegura que sus colores permanecerán intactos. Se puede desmontar. Para uso interior y exterior.

Sky Table is made of durable weather-resistant polypropylene. It is UV protected which insures the colors will not fade. It can be disassembled. For indoor and outdoor use.

La table SKY est fabriquée en polypropylène résistant aux intempéries. Dotée d'une protection UVA, ce qui permet d'éviter l'usure des couleurs. Pour un usage intérieur et extérieur.

○ Blanco | White | Blanc

● Negro | Black | Noir

● Gris Oscuro | Dark Grey | Gris Foncé

W 80 cm	W 31.50 in
L 80 cm	L 31.50 in
H 74cm	H 29.13 in

STD units	Packaging dim. (cm)	M3/pack	NW units (kg)	Units Container 20'	Units Container 40'	Units Container HC	Units Truck 70m³	Units Truck 100m³
1	82x83x14	0,095	14	336	-	742	-	1.008



OCTOPUS 60

Mesa | Table | Table



Siesta
OUTDOOR FURNITURE

Mesa fabricada en resina muy resistente y duradera. Protección UV. Desmontable. Para uso interior y exterior. Otros colores disponibles, consulte al Departamento Comercial.

Table is made of durable weather-resistant resin. It is UV protected. Can be disassembled. For indoor and outdoor use. Other available colours, contact the Sales Department.

Table fabriquée en résine très résistante et durable. Protection UV. Démontable. Pour usage intérieur et extérieur. Autres couleurs disponibles, consultez le département commercial.

○ Blanco | White | Blanc

● Negro | Black | Noir

● Gris Oscuro | Dark Grey | Gris Foncé

ø 60 cm
W 60 cm
H 75 cm

ø 23.62 cm
W 23.62 in
H 29.53 in

W: ancho / width / largeur. L: largo / length / longueur
H: altura / height / hauteur. Hs: altura asiento / seat height / hauteur du siège. Ha: altura brazo / arm height / hauteur du bras
Ø: diámetro / diameter / diamètre.

STD units	Packaging dim. (cm)	M3/pack	NW units (kg)	Units Container 20'	Units Container 40'	Units Container HC	Units Truck 70m³	Units Truck 100m³
2	39,5x62x66	0,15	4,5	350	850	850	-	1.050



ARES 80

Mesa | Table | Table



Siesta
SOLUCIONES

Blanco | White | Blanc

Negro | Black | Noir

W 80 cm | W 31.50 in
L 80 cm | L 31.50 in
H 75 cm | H 29.53 in

STD units	Packaging dim. (cm)	M3/ pack	NW units (kg)	Units Container 20'	Units Container 40'	Units Container HC	Units Truck 70m ³	Units Truck 100m ³
1	81x81x15	0,09	14	266	660	660	-	800

Mesa para uso interior y exterior fabricada en resina muy resistente y duradera. Protección UV. Desmontable. Otros colores disponibles, consulte el Departamento Comercial.

Table for indoor and outdoor use, made of very strong and durable resin. UV Protection. It can be dismantled. Other available colours, contact the Sales Department.

Table pour usage intérieur et extérieur, fabriquée en résine très résistante et durable. Protection UV. Démontable. Autres couleurs disponibles, consultez le Département Commercial.

ARES 140

Mesa | Table | Table



Siesta
SOLUCIONES

Blanco | White | Blanc

Negro | Black | Noir

W 80 cm | W 31.50 in
L 140 cm | L 55.12 in
H 75 cm | H 29.53 in

STD units	Packaging dim. (cm)	M3/ pack	NW units (kg)	Units Container 20'	Units Container 40'	Units Container HC	Units Truck 70m ³	Units Truck 100m ³
1	141x80x15	0,17	23	165	374	374	-	500

Mesa para uso interior y exterior fabricada en resina muy resistente y duradera. Protección UV. Desmontable. Otros colores disponibles, consulte el Departamento Comercial.

Table for indoor and outdoor use, made of very strong and durable resin. UV Protection. It can be dismantled. Other available colours, contact the Sales Department.

Table pour usage intérieur et extérieur, fabriquée en résine très résistante et durable. Protection UV. Démontable. Autres couleurs disponibles, consultez le Département Commercial.



BALI

Mesa | Table | Table



Bali Test
Certificates:
EN 12521



Chocolate | Chocolate | Chocolat

Blanco | White | Blanc



W 94 cm | W 37.01in
L 94 cm | L 37.01 in
H 75 cm | H 29.53 in

STD units	Packaging dim. (cm)	M3/ pack	NW units (kg)	Units Container 20'	Units Container 40'	Units Container HC	Units Truck 70m ³	Units Truck 100m ³
1	96x96x14	0,12	22	220	460	460	640	640

Mesa cuadrada para uso interior y exterior fabricada en resina muy resistente y duradera reforzada con fibra de vidrio. Protección UV. Sobre de cristal templado oscuro de 5 mm de grosor. De fácil montaje y desmontaje. Otros colores disponibles, consulte el Departamento Comercial.

Square table for indoor and outdoor use made of very strong and durable resin reinforced with fiberglass. UV protection. Table top of tempered dark glass of 5 mm thickness. Easy to assemble and disassemble. Other available colours, contact the Sales Department.

Table carrée pour usage intérieur et extérieur fabriquée en résine très solide et durable renforcée avec fibre de verre. Plateau en verre trempé foncé en 5 mm de grosseur. Montage et démontage faciles. Autres couleurs disponibles, consultez le Département Commerciale.

TAHITI

Mesa | Table | Table



TahitiTest
Certificates:
EN 12521



Chocolate | Chocolate | Chocolat



W 94 cm | W 37.01 in
L 180 cm | L 70.87 in
H 75 cm | H 29.53 in

Hasta fin de existencias | Until the end of stock | Jusqu'à épuisement du stock

STD units	Packaging dim. (cm)	M3/ pack	NW units (kg)	Units Container 20'	Units Container 40'	Units Container HC	Units Truck 70m ³	Units Truck 100m ³
1	184x96x14	0,24	32	112	280	280	320	320

Mesa rectangular para uso interior y exterior fabricada en resina muy resistente y duradera reforzada con fibra de vidrio. Protección UV. Sobre de cristal templado oscuro de 5 mm de grosor. De fácil montaje y desmontaje. Otros colores disponibles, consulte el Departamento Comercial.

Rectangular table for indoor and outdoor use made of very strong and durable resin reinforced with fiberglass. UV protection. Table top of tempered dark glass of 5 mm thickness. Easy to assemble and disassemble. Other available colours, contact the Sales Department.

Table rectangulaire pour usage intérieur et extérieur fabriquée en résine très solide et durable renforcée avec fibre de verre. Plateau en verre trempé foncé en 5 mm de grosseur. Montage et démontage faciles. Autres couleurs disponibles, consultez le Département Commerciale.

W: ancho / width / largeur. L: largo / length / longueur
H: altura / height / hauteur. Hs: altura asiento / seat height /
hauteur du siège. Ha: altura brazo / arm height / hauteur du bras
Ø: diámetro / diameter / diamètre.

ORLANDO 80

Mesa | Table | Table



Mesa para uso interior y exterior fabricada en resina muy resistente y duradera. Protección UV. Desmontable. Otros colores disponibles, consulte el Departamento Comercial.

Table for indoor and outdoor use, made of very strong and durable resin. UV Protection. It can be dismantled. Other available colours, contact the Sales Department.

Table pour usage intérieur et extérieur, fabriquée en résine très résistante et durable. Protection UV. Démontable. Autres couleurs disponibles, consultez le Département Commercial.

● Chocolate | Chocolate | Chocolat

Siesta
exclusive

W 80 cm | W 31.50 in
L 80 cm | L 31.50 in
H 75 cm | H 29.53 in

STD units	Packaging dim. (cm)	M3/ pack	NW units (kg)	Units Container 20'	Units Container 40'	Units Container HC	Units Truck 70m ³	Units Truck 100m ³
1	81x81x15	0,09	14	266	660	660	800	800

ORLANDO 140

Mesa | Table | Table



Mesa para uso interior y exterior fabricada en resina muy resistente y duradera. Protección UV. Desmontable. Otros colores disponibles, consulte el Departamento Comercial.

Table for indoor and outdoor use, made of very strong and durable resin. UV Protection. It can be dismantled. Other available colours, contact the Sales Department.

Table pour usage intérieur et extérieur, fabriquée en résine très résistante et durable. Protection UV. Démontable. Autres couleurs disponibles, consultez le Département Commercial.

● Chocolate | Chocolate | Chocolat

Siesta
exclusive

W 80 cm | W 31.50 in
L 140 cm | L 55.12 in
H 75 cm | H 29.53 in

STD units	Packaging dim. (cm)	M3/ pack	NW units (kg)	Units Container 20'	Units Container 40'	Units Container HC	Units Truck 70m ³	Units Truck 100m ³
1	141x81x15	0,17	23	165	374	374	500	500

MAMBA

Mesa | Table | Table



Apilable
Stackable | Empilable

W: ancho / width / largeur. **L:** largo / length / longueur
H: altura / height / hauteur. **Hs:** altura asiento / seat height /
hauteur du siège. **Ha:** altura brazo / arm height / hauteur du bras
Ø: diámetro / diameter / diamètre.

Mesa para uso interior y exterior de aluminio pintado por pulverización en color negro. Sobre de cristal de 8 mm de grosor pintado en color negro.

Black Spray painted aluminium table for indoor and outdoor use. Table top of painted glass in black with 8 mm thickness.

Table pour usage intérieur et extérieur en aluminium peint par pulvérisation de couleur noir, Plateau en verre de 8 mm de grousseur, peint en noir.

● Negro | Black | Noir

W 80 cm	W 31.50 in
L 80 cm	L 31.50 in
H 74 cm	H 29.13 in

STD units	Packaging dim. (cm)	M3/ pack	NW units (kg)	Units Container 20'	Units Container 40'	Units Container HC	Units Truck 70m³	Units Truck 100m³
1	83x83x10	0,07	13	312	780	780	941	941

SHIO

Mesa | Table | Table



Mesa para uso interior y exterior de aluminio pintado por pulverización en color blanco. Sobre de cristal templado de 8 mm de grosor pintado en color blanco.

White powder-coated aluminium table for indoor and outdoor use. Table top of painted tempered glass in white with an 8 mm thickness.

Table pour usage intérieur ou extérieur en aluminium peint par pulvérisation de couleur blanc, avec plateau en verre trempé de 8 mm. de grousseur, peint en blanc.

○ Blanco | White | Blanc

W 80 cm	W 31.50 in
L 80 cm	L 31.50 in
H 74 cm	H 29.13 in

STD units	Packaging dim. (cm)	M3/ pack	NW units (kg)	Units Container 20'	Units Container 40'	Units Container HC	Units Traylor 70m³	Units Truck 100m³
1	84x84x10	0,06	20	320	800	800	965	965

CUBIC

Mesa | Table | Table



Mesa para uso interior y exterior de aluminio pintado por pulverización en gris claro. Sobre de cristal templado de 8 mm de grosor.

Light grey powder-coated aluminium table for indoor and outdoor use. 8 mm thickness tempered glass table top.

Table pour usage intérieur ou extérieur en aluminium peint par pulvérisation de couleur gris clair avec plateau en verre trempé de 8 mm.

● Gris | Grey | Gris

L 80 cm	L 31.50 in
W 80 cm	W 31.50 in
H 74 cm	H 29.13 in

STD units	Packaging dim. (cm)	M3/ pack	NW units (kg)	Units Container 20'	Units Container 40'	Units Container HC	Units Truck 70m³	Units Truck 100m³
1	84x84x10	0,06	17,5	320	800	800	965	965

WOOD NEW FLASH

Mesa | Table | Table



Mesa para uso interior y exterior. Sobre inyectado en polipropileno. Patas de madera. Protección UV. Disponible en 2 medidas: 90x90 y 160x90.

Table for indoor and outdoor use. Table top injected with polypropylene. Wood legs. UV Protection. Available in two sizes: 90x90 and 160x90.

Table d'intérieur et extérieur. Plateau injecté en polypropylène. Pieds de bois. Protection UV. Disponible dans 2 mesures: 90x90 et 160x90.

○ Blanco White Blanc	W 90 cm L 90 cm H 74 cm	W 35.43 in L 35.56 in H 29.13 in	W 90 cm L 160 cm H 74 cm	W 35.43 in L 62.99 in H 29.13 in
● Chocolate Chocolate Chocolat				
● Gris Oscuro Dark Grey Gris Foncé				

W: ancho / width / largeur. **L:** largo / length / longueur
H: altura / height / hauteur. **Hs:** altura asiento / seat height /
 hauteur du siège. **Ha:** altura brazo / arm height / hauteur du bras
Ø: diámetro / diameter / diamètre.

STD units	Packaging dim. (cm)	M3/pack	NW units (kg)	Units Container 20'	Units Container 40'	Units Container HC	Units Truck 70m ³	Units Truck 100m ³
1	94x92x15	0,13	11,85	180	390	442	448	578
1	161x92x15	0,22	16,59	90	210	238	256	323

Silla Oslo (p. 230) con mesa Wood New Flash (p.273)
 Oslo chair (p. 230) with Wood New Flash table (p.273)
 Chaise Oslo (p. 230) avec table Wood New Flash (p.273)



ALEGRIA

Mesa | Table | table



Mesa para uso interior y exterior de aluminio pintado por pulverización en color blanco. Disponible en formato 70x70 y 140x80 cm. Peso neto 70x70, 8,8 kg 140x80, 13,17 kg.

Table for indoor and outdoor use in white powder coated aluminium. Available in 70x70 and 140x80 cm. Net weight 70x70, 8,8 kg (19.40 lb) 140x80, 13,17 kg (29.03 lb).

Table Alegria pour usage intérieure et extérieure peint par pulvérisation en couleur blanche. Disponible en 70x70 cm et 140x80 cm. Poids net 70x70, 8,8 kg 140x80, 13,17 kg.

- Blanco | White | Blanc

W 70 cm L 70 cm H 75 cm	W 27.56 in L 27.56 in H 29.52 in	W 140 cm L 80 cm H 75 cm	W 55.12 in L 31.50 in H 29.52 in
-------------------------------	--	--------------------------------	--

W: ancho / width / largeur. L: largo / length / longueur
H: altura / height / hauteur. Hs: altura asiento / seat height / hauteur du siège. Ha: altura brazo / arm height / hauteur du bras
Ø: diámetro / diameter / diamètre.

STD units	Packaging dim. (cm)	M3/ pack	NW units (kg)	Units Container 20'	Units Container 40'	Units Container HC	Units Truck 70m ³	Units Truck 100m ³
14	100x100x235	2,35	8,8	495	990	-	-	-
14	162x162x235	6,17	13,17	264	572	-	-	-

MONTBLANC

Mesa | Table | Table



Mesa de 80 x 80 cm con sobre Werzalit. Pies atornillados de aluminio anodizado mate.

Table 80 x 80 cm with Werzalit table top. Screwed anodized aluminium legs. Matt finish.

Table 80 x 80 cm avec plateau Werzalit. Pieds vissés en aluminium anodisé mat.

- Stratos | Stratos | Stratos
- Blanco | White | Blanc

W 80 cm L 80 cm	W 31.50 in L 31.50 in
--------------------	--------------------------
- Wengé | Wenge | Wenge

H 73 cm	H 28.74 in
---------	------------

W: ancho / width / largeur. L: largo / length / longueur
H: altura / height / hauteur. Hs: altura asiento / seat height / hauteur du siège. Ha: altura brazo / arm height / hauteur du bras
Ø: diámetro / diameter / diamètre.

STD units	Packaging dim. (cm)	M3/ pack	NW units (kg)	Units Container 20'	Units Container 40'	Units Container HC	Units Truck 70m ³	Units Truck 100m ³
1	81x81x17	0,11	10,7	245	518	609	636	909

RIPOLL

Mesa | Table | Table



Mesa de 120 x 80 cm con sobre Werzalit. Pies de aluminio anodizado mate.

Table 120 x 80 cm with Werzalit table top. Anodized aluminium legs. Matt finish.

Table 120 x 80 cm avec plateau Werzalit. Pieds en aluminium anodisé mat.

- Blanco | White | Blanc

W 80 cm L 120 cm H 73 cm	W 31.50 in L 47.24 in H 28.74 in
--------------------------------	--
- Wengé | Wenge | Wenge
- Stratos | Stratos | Stratos

STD units	Packaging dim. (cm)	M3/ pack	NW units (kg)	Units Container 20'	Units Container 40'	Units Container HC	Units Truck 70m ³	Units Truck 100m ³
1	121x82x17	0,17	16,1	124	254	302	312	422

KIBO

Mesa | Table | Table



Mesa de metal pintado con acabado antiguo. Apilable. Para uso interior y exterior. Mesa combinable con silla Kibo (ver pag. 254).

Metal table with antique cream finished. Stackable. For indoor and outdoor use. Table combinable with Kibo chair (See at pag. 254).

Table en métal peinte avec finition ancienne. Empilable. Pour usage intérieur et extérieur. Table combinable avec chaise Kibo (Voir pag. 254).

● Crema | Cream | Crème

W 80 cm | W 31.50 in
L 80 cm | L 31.50 in
H 75 cm | H 29.53 in

STD units	Packaging dim. (cm)	M3/ pack	NW units (kg)	Units Container 20'	Units Container 40'	Units Container HC	Units Truck 70m ³	Units Truck 100m ³
1	82x82x12	-	-	330	680	680	-	-

NAXOS

Mesa | Table | Table



Mesa redonda para uso interior y exterior de aluminio. Sobre en mosaico.

Circular aluminium table for indoor and outdoor use. Mosaic table top.

Table ronde pour un usage intérieur et extérieur en aluminium. Plateau en mosaïque.

Ø 59 cm | Ø 23.23 in
H 71 cm | H 27.95 in

STD units	Packaging dim. (cm)	M3/ pack	NW units (kg)	Units Container 20'	Units Container 40'	Units Container HC	Units Truck 70m ³	Units Truck 100m ³
1	63x10x75	0,07	24	571	1.206	1.418	-	-

PAROS

Mesa | Table | table



Mesa para uso interior y exterior de aluminio. Sobre en mosaico.

Aluminium table for indoor and outdoor use. Mosaic table top.

Table pour un usage intérieur et extérieur en aluminium. Plateau en mosaïque.

W 70 cm | W 27.56 in
L 70 cm | L 27.56 in
H 75 cm | H 29.53 in

STD units	Packaging dim. (cm)	M3/ pack	NW units (kg)	Units Container 20'	Units Container 40'	Units Container HC	Units Truck 70m ³	Units Truck 100m ³
1	75x10x75	0,056		780	1.013	1.191	-	-

W: ancho / width / largeur. L: largo / length / longueur
H: altura / height / hauteur. Hs: altura asiento / seat height / hauteur du siège. Ha: altura brazo / arm height / hauteur du bras
Ø: diámetro / diameter / diamètre.

BERLIN

Mesa | Table | Table



Mesa apilable para uso interior y exterior con patas de acero enroscables. Sobre fabricado a partir de dos piezas inyectadas en polipropileno aditivado con protector de rayos UV, y soldadas por vibración. Patas de acero de Ø30x1,5 mm de grosor, pintadas por pulverización al horno con pintura poliéster. Agujero parasol de 38mm con tapa. Combinable con parasoles UD2 y MD1 (catálogo Garden).

Stackable table for indoor and outdoor use with threaded steel legs. Tabletop manufactured from two pieces injected in polypropylene additive with UV protection, and welded by vibration. Steel legs Ø30x1.5 mm thick, spray-painted in the oven with polyester paint. Hole of 38mm with lid. Combinable with parasols UD2 and MD1 (Garden catalogue).

Table empilable pour usage intérieur et extérieur avec pieds en acier filetés. Dessus de table fabriqué à partir de deux pièces injectées en polypropylène avec protection UV, et soudé par vibration. Pieds en acier Ø30x1,5 mm d'épaisseur, peints au pistolet à four avec peinture polyester. Parasol 38 mm avec couvercle. Combinable avec parasols UD2 et MD1 (catalogue Garden).

Sobre + patas | table + legs | plateau + pieds

W 70 cm	W 27.56 in
L 70 cm	L 27.56 in
H 74 cm	H 29.13 in

Blanco/blanco | White/White | Blanc/Blanc

Rojo/Rojo | Red/Red | Rouge/Rouge

STD units	Packaging dim. (cm)	M3/pack	NW units (kg)	Units Container 20'	Units Container 40'	Units Container HC	Units Truck 70m³	Units Truck 100m³
1	79x79x7,5	0,05	5,7	297	675	675	891	972
27	80x120x220	2,11	5,7	297	675	675	891	972

ZURICH

Mesa | Table | Table



Mesa apilable para uso interior y exterior con patas de acero enroscables. Sobre fabricado a partir de dos piezas inyectadas en polipropileno aditivado con protector de rayos UV y soldadas por vibración. Patas de acero de Ø30x1,5 mm de grosor, pintadas por pulverización al horno con pintura poliéster.

Stackable table for indoor and outdoor use with threaded steel legs. Tabletop manufactured from two pieces injected in polypropylene additive with UV protection and welded by vibration. Steel legs Ø30x1.5 mm thick, spray-painted in the oven with polyester paint.

Table empilable pour usage intérieur et extérieur avec pieds en acier filetés. Dessus de table fabriqué à partir de deux pièces injectées en additif polypropylène avec protection UV et soudées par vibration. Pieds en acier Ø30x1,5 mm d'épaisseur, peints au pistolet au four avec peinture polyester.

Sobre + patas | table + legs | plateau + pieds

W 70 cm	W 27.56 in
L 70 cm	L 27.56 in
H 74 cm	H 29.13 in

Blanco/blanco | White/White | Blanc/Blanc

Arena/Arena | Sand/Sand | Sable/Sable

Rojo/Rojo | Red/Red | Rouge/Rouge

Apilable
Stackable | Empilable

W: ancho / width / largeur. L: largo / length / longueur
H: altura / height / hauteur. Hs: altura asiento / seat height / hauteur du siège. Ha: altura brazo / arm height / hauteur du bras
Ø: diámetro / diameter / diamètre.

STD units	Packaging dim. (cm)	M3/pack	NW units (kg)	Units Container 20'	Units Container 40'	Units Container HC	Units Truck 70m³	Units Truck 100m³
1	79x79x7,5	0,05	5,7	297	675	675	891	972
27	80x120x220	2,11	5,7	297	675	675	891	972

MARSELLA

Mesa | Table | Table



Mesa apilable para uso interior y exterior con patas polipropileno y fibra de vidrio enroscables. Sobre fabricado a partir de dos piezas inyectadas en polipropileno aditivado con protector de rayos UV y soldadas por vibración.

Stackable table for indoor and outdoor use with screwed polypropylene and fiberglass legs. Tabletop manufactured from two pieces injected in polypropylene additive with UV protection and welded by vibration.

Table empilable pour usage intérieur et extérieur avec pieds vissés en polypropylène et fibre de verre. Dessus de table fabriqué à partir de deux pièces injectées en polypropylène avec protection UV et soudées par vibration.

Sobre + patas | table + legs | plateau + pieds

W 70 cm | W 27.56 in
L 70 cm | L 27.56 in
H 74 cm | H 29.13 in

- Arena/Arena | Sand/Sand | Sable/Sable
- Blanco/blanco | White/White | Blanc/Blanc
- Arena/Blanco | Sand/White | Sable /Blanc

STD units	Packaging dim. (cm)	M3/ pack	NW units (kg)	Units Container 20'	Units Container 40'	Units Container HC	Units Truck 70m³	Units Truck 100m³
1	79x79x7,5	0,05	5,7	297	675	675	891	972
27	80x120x220	2,11	5,7	297	675	675	891	972

LONDON

Mesa | Table | Table



Mesa apilable para uso interior y exterior con patas polipropileno y fibra de vidrio enroscables. Sobre fabricado a partir de dos piezas inyectadas en polipropileno aditivado con protector de rayos UV y soldadas por vibración. Agujero parasol de 38mm con tapa. Combinable con parasoles UD2 y MD1 (catálogo Garden).

Stackable table for indoor and outdoor use with screwed polypropylene and fiberglass legs. Tabletop manufactured from two pieces injected in polypropylene additive with UV protection and welded by vibration. Hole of 38mm with lid. Combinable with parasols UD2 and MD1 (Garden catalogue).

Table empilable pour usage intérieur et extérieur avec pieds vissés en polypropylène et fibre de verre. Dessus de table fabriqué à partir de deux pièces injectées en additif de polypropylène avec protection UV et soudées par vibration. Parasol 38mm avec couvercle. Combinable avec parasols UD2 et MD1 (catalogue Garden).

Sobre + patas | table + legs | plateau + pieds

W 70 cm | W 27.56 in
L 70 cm | L 27.56 in
H 74 cm | H 29.13 in

- Blanco/blanco | White/White | Blanc/Blanc
- Arena/Arena | Sand/Sand | Sable/Sable

STD units	Packaging dim. (cm)	M3/ pack	NW units (kg)	Units Container 20'	Units Container 40'	Units Container HC	Units Truck 70m³	Units Truck 100m³
1	79x79x7,5	0,05	5,7	297	675	675	891	972
27	80x120x220	2,11	5,7	297	675	675	891	972



Silla Malta con respaldo bajo (pág. 235) con mesas Zurich y Berlin (pág. 276)
Low backrest armchair (pag. 235) with Zurich table and Berlin table (pag. 276)
Fauteuil Malta dossier bas (pag. 235) avec table Zurich et table Berlin (pag. 276)



MALTA

DAVID CARRASCO BARCELÓ

Mesa | Table | Table



○ Blanco | White | Blanc

● Rojo | Red | Rouge

W 70 cm | W 27.56 in
L 70 cm | L 27.56 in
H 75 cm | H 29.53 in

STD units	Packaging dim. (cm)	M3/ pack	NW units (kg)	Units Container 20'	Units Container 40'	Units Container HC	Units Truck 70m ³	Units Truck 100m ³
30	100x120x240	2,9	9,7	300	702	792	-	858

Mesa apilable para uso interior y exterior. Sobre fabricado a partir de dos piezas inyectadas en polipropileno aditivado con protector de rayos UV, y soldadas por vibración. Patas de acero de Ø30x1,5 mm de grosor, pintadas por pulverización al horno con pintura poliéster. Dispone de 4 colgadores en la parte inferior del tablero para mayor comodidad y seguridad. Agujero parasol de 38mm con tapa. Peso neto 9,70 kg. Combinables con parasoles UD2 y MD1 (catálogo Garden).

Stackable table for indoor and outdoor use. Steel legs Ø30x1,5 mm thick, polyester powder-coating painted. Table top made in two pieces injected in polypropylene with UV protection joined by ultrasonic welding. It has 4 hangers in the table top bottom to offer more comfortability and security. 38mm umbrella hole with cap. Net weight 9,70 kg (21.38 lb). Combinable with parasols UD2 and MD1 (Garden catalogue).

Table empilable pour une utilisation intérieure et extérieure. Pieds fabriqués en acier mm Ø30x1,5 mm épaisseur, peintes avec de la peinture polyester. Plateau réalisé en deux pièces injectées en polypropylène avec protection UV avec soudage par ultrasons. Elle dispose de 4 crochets en dessous du plateau pour offrir plus de confort et de sécurité. Trou de parasol du 38mm avec cache-trou. Poids net 9,70 kg. Combinable avec parasols UD2 et MD1 (catalogue Garden).

CORE

Mesa | Table | table



Mesa apilable cuadrada para uso interior y exterior. Patas de acero Ø28 pintadas por pulverización al horno con pintura poliéster. Tablero disponible en compacto fenólico de 70x70 (Ver colores en pág. 296)

Stackable squared table for indoor and outdoor use. Steel legs Ø28 mm, polyester powder-coating painted. Table top available in HPL of 70x70. (See colours on p. 296)

Table empilable carée pour usage intérieur et extérieur. Pieds fabriqués en acier Ø28mm peintes avec de la peinture polyester. Tableau disponible en résine phénolique de 70x70. (Voir couleurs pag. 296)

W 70 cm | W 27.56 in
L 70 cm | L 27.56 in
H 74 cm | H 29.13 in

STD units	Packaging dim. (cm)	M3/ pack	NW units (kg)	Units Container 20'	Units Container 40'	Units Container HC	Units Truck 70m ³	Units Truck 100m ³
1	82x82x12	0,04	11	550	1.250	1.250	1.650	1.800
50	80x120x220	2,11	11	550	1.250	1.250	1.650	1.800
1	80x120x90	0,86	11	220	500	500	660	720
50	80x120x220	2,11	11	220	500	500	660	720

Apilable
Stackable | Empilable

W: ancho / width / largeur. L: largo / length / longueur
H: altura / height / hauteur. Hs: altura asiento / seat height / hauteur du siège. Ha: altura brazo / arm height / hauteur du bras
Ø: diámetro / diameter / diamètre.



RAYA

Mesa | Table | Table



Raya Test Certificates:
EN 581-1
EN 581-2
General Public Use

Mesa apilable cuadrada (60 x 60 / 70 x 70 / 80 x 80 cm) para exterior. Estructura tubular, ø 28 x 2 mm de grosor, de aluminio anodizado brillante. Tablero de 20 mm con sobre de Inox 304 repulsado con grosor de 2mm, con interior aglomerado de alta densidad con tratamiento ignífugo e hidrófugo. Tornillos de acero inoxidable.

Stackable square table (60 x 60 / 70 x 70 / 80 x 80 cm) for outdoor use. Tubular shaped frame, ø 28 x 2 mm thick, anodized aluminium, shiny finish. Table top 20 mm thick with 304 stainless Steel bevelled top 2 mm thick. High density conglomerate core with fire retardant and water repellent treatment. Stainless steel screws.

Table empilable carrée (60 x 60 / 70 x 70 / 80 x 80 cm) pour extérieur. Structure tubulaire, ø 28 x 2 mm de grosueur, en aluminium anodisé brillant. Plateau de 20 mm de grosueur, avec surface en Inox 304 repoussé de 2 mm de grosueur, avec intérieur aggloméré de haute desité avec traitment L 60 x W 60 x H 70 cm hydrofuge et antifeu. Vis en acier inoxydable.

L 60 cm	L 23.62 in	L 70 cm	L 27.56 in	L 80 cm	L 31.50 in
W 60 cm	W 23.62 in	W 70 cm	W 27.56 in	W 80 cm	W 31.50 in
H 70 cm	H 27.56 in	H 70 cm	H 27.56 in	H 70 cm	H 27.56 in

STD units	Packaging dim. (cm)	M3/ pack	NW units (kg)	Units Container 20'	Units Container 40'	Units Container HC	Units Truck 70m³	Units Truck 100m³
18	75x75x235	1,32	11,5	432	864	864	918	1.026

RAYA 2

Mesa | Table | Table



Mesa apilable cuadrada (60 x 60 / 70 x 70 / 80 x 80 cm) para exterior. Estructura tubular, ø 28x 2 mm de grosor, de aluminio anodizado brillante. Tablero Werzalit.

Stackable square table (60 x 60 / 70 x 70 / 80 x 80 cm) for outdoor use. Tubular shaped frame, ø 28 x 2 mm thick, anodized aluminium, shiny finish. Werzalit table top.

Table empilable carrée (60 x 60 / 70 x 70 / 80 x 80 cm) pour extérieur. Structure tubulaire, ø 28x 2 mm de grosueur, en aluminium anodisé brillant. Plateau en Werzalit.

L 60 cm	L 23.62 in	L 70 cm	L 27.56 in	L 80 cm	L 31.50 in
W 60 cm	W 23.62 in	W 70 cm	W 27.56 in	W 80 cm	W 31.50 in
H 72 cm	H 28.35 in	H 72 cm	H 28.35 in	H 72 cm	H 28.35 in

RAYA 3

Mesa | Table | Table



Mesa apilable cuadrada (60 x 60 / 70 x 70 / 80 x 80 cm) para exterior. Estructura tubular, ø 28 x 2 mm de grosor, de aluminio anodizado brillante. Tablero en compacto fenólico. (Ver colores en pág. 296).

Stackable square table (60 x 60 / 70 x 70 / 80 x 80 cm) for outdoor use. Tubular shaped frame, ø 28 x 2 mm thick, anodized aluminium, shiny finish. HPL table top. (See colors on p. 296).

Table empilable carrée (60 x 60 / 70 x 70 / 80 x 80 cm) pour extérieur. Structure tubulaire, ø 28 x 2 mm de grosueur, en aluminium anodisé brillant. Plateau en résine phénolique. (Voir couleurs pag. 296).

Apilable
Stackable | Empilable



W 80 cm	W 31.50 in
L 80 cm	L 31.50 in
H 72 cm	H 28.34 in

W: ancho / width / largeur. L: largo / length / longueur
H: altura / height / hauteur. Hs: altura asiento / seat height / hauteur du siège. Ha: altura brazo / arm height / hauteur du bras
Ø: diámetro / diameter / diamètre.

OLA

Mesa | Table | Table



ø 60 cm | ø 23.62 in
 ø 70 cm | ø 27.56 in
 H 70 cm | H 27.56 in

Mesa apilable redonda (ø 60 / ø 70 cm) para exterior. Estructura tubular, ø 28 x 2 mm de grosor, de aluminio anodizado brillante. Tablero de 20 mm con sobre de Inox 304 repulsado con grosor de 2mm, con interior aglomerado de alta densidad con tratamiento ignífugo e hidrófugo. Tornillos de acero inoxidable.

Stackable round table (ø 60 / ø 70 cm) for outdoor use. Tubular shaped frame, ø 28 x 2 mm thick, anodized aluminium, shiny finish. Table top 20 mm thick with 304 stainless Steel bevelled top 2 mm thick. High density conglomerate core with fire retardant and water repellent treatment. Stainless steel screws.

Table empilable ronde (ø 60 / ø 70 cm) pour extérieur. Structure tubulaire, ø 28 x 2 mm de grosueur, en aluminium anodisé brillant. Plateau de 20 mm de grosueur, avec surface en Inox 304 repoussé de 2 mm de grosueur. Avec intérieur aggloméré de haute densité avec traitement hydrofuge et antifeu. Vis en acier inoxydable.

STD units	Packaging dim. (cm)	M3/ pack	NW units (kg)	Units Container 20'	Units Container 40'	Units Container HC	Units Truck 70m³	Units Truck 100m³
20	63x63x23	0,91	7,7	540	1.140	1.140	1.260	1.440
20	73x73x230	1,22	10,2	480	960	960	1.080	1.200

OLA 2

Mesa | Table | Table



Mesa apilable redonda para exterior. Estructura tubular, ø 28 x 2mm de grosor, de aluminio anodizado brillante. Tablero Werzalit. (Ver colores en pág. 294).

Stackable round table for outdoor use. Tubular shaped frame, ø 28 x 2 mm thick, anodized aluminium, shiny finish. Werzalit table top. (See colors on p. 294).

Table empilable ronde pour extérieur. Structure tubulaire, ø 28 x 2 mm de grosueur, en aluminium anodisé brillant. Plateau Werzalit. (Voir couleurs pag. 294).



ø 60 cm | ø 23.62 in
 H 72 cm | H 28.34 in

OLA 3

Mesa | Table | Table



Mesa apilable redonda (ø 60 / ø 70 / ø 80 cm) para exterior. Estructura tubular, ø 28 x 2 mm de grosor, de aluminio anodizado brillante. Tablero Compacto Fenólico. (Ver colores en pág. 296).

Stackable round table (ø 60 / ø 70 / ø 80 cm) for outdoor use. Tubular shaped frame, ø 28 x 2 mm thick, anodized aluminium, shiny finish. HPL table top. (See colors on p. 296).

Table empilable ronde (ø 60 / ø 70 / ø 80 cm) pour extérieur. Structure tubulaire, ø 28 x 2 mm de grosueur, en aluminium anodisé brillant. Plateau Résine Phénolique. (Voir couleurs pag. 296).

 Apilable
 Stackable | Empilable



ø 60 cm | ø 23.62 in
 ø 70 cm | ø 27.56 in
 ø 80 cm | ø 31.49 in
 H 72 cm | H 28.34 in

W: ancho / width / largeur. **L:** largo / length / longueur
H: altura / height / hauteur. **Hs:** altura asiento / seat height / hauteur du siège. **Ha:** altura brazo / arm height / hauteur du bras
Ø: diámetro / diameter / diamètre.

BEACH BAR

Mesa | Table | Table



Mesa monobloc para uso exterior. Inyectada en polipropileno. Apilable. Protección UV. Con agujero para sombrilla. Peso neto 4,75 kg.

Monoblock table for outdoor use. Injected in polypropylene. Stackable. UV Protection. It has a hole for umbrella. Net weight 4,7 kg (10.36 lb).

Table monobloc pour extérieur. Injectée en polypropylène. Empilable. Protection UV. Avec trou de parasol. Poids net 4,75 kg.



Apilable
Stackable | Empilable

○ Blanco | White | Blanc

● Verde Oscuro | Dark Green | Vert Foncé

W 70 cm

L 70 cm

H 72 cm

W 27.56 in

L 27.56 in

H 28.35 in

W: ancho / width / largeur. L: largo / length / longueur

H: altura / height / hauteur. Hs: altura asiento / seat height / hauteur du siège. Ha: altura brazo / arm height / hauteur du bras

Ø: diámetro / diameter / diamètre.

STD units	Packaging dim. (cm)	M3/ pack	NW units (kg)	Units Container 20'	Units Container 40'	Units Container HC	Units Trayler 70m ³	Units Truck 100m ³
27	82x75x225	1,38	4,75	486	1.107	1.107	1.323	1.323

SKY LOUNGE

Mesa auxiliar | Side table | Table auxiliaire

NEW



La mesa Sky lounge está fabricada en polipropileno resistente a la intemperie. Con protección UV, lo que asegura que sus colores permanecieran intactos. Se puede desmontar. Para uso interior y exterior.

Sky lounge table is made of durable weather-resistant polypropylene. It is UV protected which insures the colors will not fade. Can be disassembled. For indoor and outdoor use.

La table SKY lounge est fabriquée en polypropylène résistant aux intempéries. Dotée d'une protection UVA, ce qui permet d'éviter l'usure des couleurs. Pour un usage intérieur et extérieur.

○ Blanco | White | Blanc

● Negro | Black | Noir

● Gris Oscuro | Dark Grey | Gris Foncé

W 100 cm

L 60 cm

H 40 cm

W 39.37 in

L 23.62 in

H 15.75 in

W: ancho / width / largeur. L: largo / length / longueur

H: altura / height / hauteur. Hs: altura asiento / seat height / hauteur du siège. Ha: altura brazo / arm height / hauteur du bras

Ø: diámetro / diameter / diamètre.

STD units	Packaging dim. (cm)	M3/ pack	NW units (kg)	Units Container 20'	Units Container 40'	Units Container HC	Units Truck 70m ³	Units Truck 100m ³
1	101x61x9	0,055	7,3	500	-	1.200	-	1.400



Mesa Sky Lounge (p. 284) Silla Sky Lounge (p. 211)
Sky Lounge table (p. 284) Sky Lounge chair (p. 211)
Table Sky Lounge (p. 284) Chaise Sky Lounge (p. 211)

MIAMI

Mesa | Table | Table



Mesa de centro para uso interior y exterior fabricada en resina muy resistente y duradera reforzada con fibra de vidrio. Protección UV. Otros colores disponibles, consulte el Departamento Comercial.

Coffee table for indoor and outdoor use made of very strong and durable resin reinforced with fiberglass. UV protection. Other available colours, contact the Sales Department.

Table basse pour usage intérieur et extérieur fabriquée en résine très solide et durable renforcée avec fibre de verre. Protection UV. Autres couleurs disponibles, consultez le Département Commerciale.

● Chocolate | Chocolate | Chocolat

W 92 cm | W 36.22 in

○ Blanco | White | Blanc

L 53 cm | L 20.87 in

H 45 cm | H 17.72 in

Siesta
exclusive

STD units	Packaging dim. (cm)	M3/ pack	NW units (kg)	Units Container 20'	Units Container 40'	Units Container HC	Units Truck 70m³	Units Truck 100m³
1	93x54x15	0,07	4,6	400	800	800	1.000	1.000

MIAMI

Mesa auxiliar |

Side table |

Table auxiliaire



Mesa auxiliar para uso interior y exterior fabricada en resina muy resistente y duradera reforzada con fibra de vidrio. Protección UV. Otros colores disponibles, consulte el Departamento Comercial.

Side table for indoor and outdoor use made of very strong and durable resin reinforced with fiberglass. UV protection. Other available colours, contact the Sales Department.

Table auxiliaire pour usage intérieur et extérieur fabriquée en résine très solide et durable renforcée avec fibre de verre. Protection UV. Autres couleurs disponibles, consultez le Département Commerciale.

● Chocolate | Chocolate | Chocolat

W 45 cm

W 17.72 in

○ Blanco | White | Blanc

L 45 cm

L 17.72 in

H 45 cm | H 17.72 in

Siesta
exclusive

STD units	Packaging dim. (cm)	M3/ pack	NW units (kg)	Units Container 20'	Units Container 40'	Units Container HC	Units Truck 70m³	Units Truck 100m³
1	47x47x15	0,03	2,5	900	1.800	1.800	2.400	2.400

W: ancho / width / largeur. L: largo / length / longueur

H: altura / height / hauteur. Hs: altura asiento / seat height / hauteur du siège. Ha: altura brazo / arm height / hauteur du bras

Ø: diámetro / diameter / diamètre.

MONACO
MESA RATTAN

Mesa | Table | Table



Mesa para uso interior y exterior fabricada en resina muy resistente y duradera reforzada con fibra de vidrio. Protección UV. Se puede desmontar. Otros colores disponibles, consulte el Departamento Comercial.

Table for indoor and outdoor made of very strong and durable resin reinforced with fiberglass. UV protection. Can be disassembled. Other available colours, contact the Sales Department.

Table pour une utilisation intérieure et extérieure fabriqué en résine très solide et durable renforcé avec fibre de verre. Protection UV. Peut être démonté. Autres couleurs disponibles, consultez le Département Commerciale.

● Chocolate | Chocolate | Chocolat

W 92 cm

W 36.22 in

L 57 cm

L 22.44 in

H 45 cm

H 17.71 in

Siesta
exclusive

STD units	Packaging dim. (cm)	M3/ pack	NW units (kg)	Units Container 20'	Units Container 40'	Units Container HC	Units Truck 70m³	Units Truck 100m³
1x	94x58x18	0,098	10	330	800	800	950	-

W: ancho / width / largeur. L: largo / length / longueur

H: altura / height / hauteur. Hs: altura asiento / seat height / hauteur du siège. Ha: altura brazo / arm height / hauteur du bras

Ø: diámetro / diameter / diamètre.

OCTOPUS BAR

Mesa | Table | Table



Mesa fabricada en resina muy resistente y duradera. Protección UV. Estructura metálica. Desmontable. Para uso interior y exterior. Otros colores disponibles, consulte al Departamento Comercial.

Table is made of durable weather-resistant resin. It is UV protected. Metallic frame. Can be disassembled. For indoor and outdoor use. Other available colours, contact the Sales Department.

Table fabriquée en résine très résistante et durable. Protection UV. Structure métallique. Démontable. Pour usage intérieur et extérieur. Autres couleurs disponibles, consultez le département commercial.

Blanco | White | Blanc

Gris Oscuro | Dark Grey | Gris Foncé

Ø 60 cm | Ø 23.62 in
W 60 cm | W 23.62 in
H 108 cm | H 42.52 in

W: ancho / width / largeur. L: largo / length / longueur
H: altura / height / hauteur. Hs: altura asiento / seat height / hauteur du siège. Ha: altura brazo / arm height / hauteur du bras
Ø: diámetro / diameter / diamètre.

STD units	Packaging dim. (cm)	M3/ pack	NW units (kg)	Units Container 20'	Units Container 40'	Units Container HC	Units Truck 70m³	Units Truck 100m³
2	39x76x64	0,19	5	280	700	700	-	850

ESCULAPI

Mesa | Table | Table



Mesa para uso exterior inyectada en polipropileno con pie central embutido con gran estabilidad. Disponible en redonda de Ø70 cm y cuadrada de 70x70 cm. Peso neto Ø70, 7,25 kg, 70x70, 9,4 kg.

Table for outdoor use injected in polypropylene with pressure-fitted pedestal base with great stability. Available in round Ø70 cm and squared 70x70 cm. Net weight Ø70, 7,25 kg (15,98 lb), 70x70, 9,4 kg (20.72 lb).

Table pour usage extérieur, injectée en polypropylène avec pied central emboîté et grande stabilité. Disponible en ronde de Ø70 cm et carrée de 70x70 cm. Poids net Ø70, 7,25 kg, 70x70, 9,4 kg.

Blanco | White | Blanc

Antracita | Antracite | Antracite

Ø 70 cm | Ø 27.56 in
H 73 cm | H 28.74 in
W 70 cm | W 27.56 in
L 70 cm | L 27.56 in
H 73 cm | H 28.74 in

Esculapi Test Certificates: EN 581 PUBLIC



STD units	Packaging dim. (cm)	M3/ pack	NW units (kg)	Units Container 20'	Units Container 40'	Units Container HC	Units Truck 70m³	Units Truck 100m³
1	100x100x235	2,35	7,25	168	357	408	456	504
30	140X90X222	2,80	7,25	300	630	720	-720	810

BANYOLES

Mesa | Table | Table



Mesa de polipropileno con pie central embutido. Peso neto 6,6 kg.

Polypropylene table with pressure-fitted pedestal. Net weight 6,6 kg (14.55 lb).

Table pour guéridon de polypropylène avec pied central emboîté. Poids net 6,6 kg.

Blanco | White | Blanc

Antracita | Antracite | Antracite

Ø 60 cm | Ø 23.62 in
H 73 cm | H 28.74 in

STD units	Packaging dim. (cm)	M3/ pack	NW units (kg)	Units Container 20'	Units Container 40'	Units Container HC	Units Truck 70m³	Units Truck 100m³
1	161X15X77	0,07	6,65	420	840	840	1.000	-
30	120X90X220	2,38	6,65	300	660	660	900	960

TABURETES

STOOLS | TABOURETS

TABURETES | STOOLS | TABOURETS

Air Bar 65	290
Air Bar 75	290
Fox 75	292
Gio	292
Jamaica	293
Kibo alto	294
Kibo bajo	294
Jed	295
Hal	295
Alegria	295

AIR BAR 75

Taburete | Stool | Tabouret

Air Bar Test Certificates:
EN 581 PUBLIC

Siesta

CATAS

W 45 cm | W 17.72 in
L 53 cm | L 20.87 in
H 105 cm | H 41.34 in
Hs 75 cm | Hs 29.53 in



Taburete para uso interior y exterior, inyectado en polipropileno y fibra de vidrio mediante tecnología de moldeo asistida por gas. Protección UV. Disponible en dos alturas. Otros colores disponibles, consulte al Departamento Comercial.

Stool for indoor and outdoor use, injected with fiberglass and PP using gas assisted injection moulding technology. Table auxiliaire empilable en polypropylène pour usage intérieur ou extérieur. Protection U.V. Available in two heights. Other available colours, contact the Sales Department.

Tabouret d'intérieur et extérieur, injectée avec fibre de verre et PP, en utilisant technologie de moulage assistée par gaz. Protection UV. Disponible avec deux hauteurs. Autres couleurs disponibles, consultez le Département Commerciale.

- Blanco | White | Blanc
- Rojo | Red | Rouge

STD units	Packaging dim. (cm)	M3/ pack	NW units (kg)	Units Container 20'	Units Container 40'	Units Container HC	Units Truck 70m ³	Units Truck 100m ³
4	46x68x90	0,28	5	408	816	816	960	960

AIR BAR 65

Taburete | Stool | Tabouret

Air Bar Test Certificates:
EN 581 PUBLIC / en 16139 L1

CATAS

W 44 cm | W 17.32 in
L 51 cm | L 20.08 in
H 95 cm | H 37.40 in
Hs 65 cm | Hs 25.59 in



Taburete para uso interior y exterior, inyectado en polipropileno y fibra de vidrio mediante tecnología de moldeo asistida por gas. Protección UV. Disponible en dos alturas. Otros colores disponibles, consulte al Departamento Comercial.

Stool for indoor and outdoor use, injected with fiberglass and PP using gas assisted injection moulding technology. Table auxiliaire empilable en polypropylène pour usage intérieur ou extérieur. Protection U.V. Available in two heights. Other available colours, contact the Sales Department.

Tabouret d'intérieur et extérieur, injectée avec fibre de verre et PP, en utilisant technologie de moulage assistée par gaz. Protection UV. Disponible avec deux hauteurs. Autres couleurs disponibles, consultez le Département Commerciale.

- Blanco | White | Blanc
- Rojo | Red | Rouge

W: ancho / width / largeur. L: largo / length / longueur
H: altura / height / hauteur. Hs: altura asiento / seat height / hauteur du siège. Ha: altura brazo / arm height / hauteur du bras
Ø: diámetro / diameter / diamètre.

STD units	Packaging dim. (cm)	M3/ pack	NW units (kg)	Units Container 20'	Units Container 40'	Units Container HC	Units Truck 70m ³	Units Truck 100m ³
4	46x68x90	0,28	4,5	408	816	816	960	960



FOX 75

Taburete | Stool | Tabouret

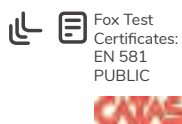

W 36 cm | W 14.17 in
L 36 cm | L 14.17 in
H 75 cm | H 29.53 in



Taburete apilable para uso interior y exterior. Inyectado en policarbonato y con protección U.V. Otros colores disponibles, consulte al Departamento Comercial.

Stackable stool for indoor and outdoor use. Injected in polycarbonate with U.V. protection. Other available colours, contact the Sales Department.

Tabouret empilable pour intérieur et extérieur. Injecté en polycarbonate et protection U.V. Autres couleurs disponibles, consultez le Département Commerciale.

⊗ Transparente | Transparent | Transparent

STD units	Packaging dim. (cm)	M3/ pack	NW units (kg)	Units Container 20'	Units Container 40'	Units Container HC	Units Truck 70m³	Units Truck 100m³
2	39x39x115	0,18	3,05	360	720	720	980	980

GIO

Taburete | Stool | Tabouret



W 39 cm | W 15.35 in
L 45 cm | L 17.72 in
H 96 cm | H 37.80 in
Hs 75 cm | Hs 29.53 in

- Blanco | White | Blanc
- Negro | Black | Noir
- Salmón | Salmon | Salmon
- Beige | Beige | Beige



Taburete apilable para uso interior y exterior. Estructura de aluminio anodizado de 25 x 25 mm y 2 mm de grosor. Asiento y respaldo de polipropileno. Uniones de poliamida y fibra de vidrio. Con sistema de evacuación de agua, protección UV y tacos antideslizantes. Otros colores disponibles, consulte al Departamento Comercial.

Stackable stool for indoor and outdoor use. Anodized aluminium structure of 25 x 25 mm and 2 mm thickness. Seat and back of polypropylene. Polyamide and fiberglass joints. Water drainage system, with UV protection and nonslip pads. Other available colours, contact the Sales Department.

Tabouret empilable pour usage intérieur ou extérieur. Structure en aluminium anodisé 25 x 25 mm et 2 mm de grosseur. Siège et dossier en polypropylène. Raccords en polyamide et fibre de verre. Système d'évacuation d'eau. Protection UV et basses antidérapantes. Autres couleurs disponibles, consultez le Département Commerciale.

⌵ Apilable
Stackable | Empilable

W: ancho / width / largeur. L: largo / length / longueur
H: altura / height / hauteur. Hs: altura asiento / seat height / hauteur du siège. Ha: altura brazo / arm height / hauteur du bras
Ø: diámetro / diameter / diamètre.

STD units	Packaging dim. (cm)	M3/ pack	NW units (kg)	Units Container 20'	Units Container 40'	Units Container HC	Units Truck 70m³	Units Truck 100m³
4	49x62x117	0,35	3,6	288	605	608	880	880

JAMAICA

Taburete | Stool | Tabouret



Taburete para uso interior y exterior fabricado en resina muy resistente y reforzado con fibra de vidrio. Protección UV. Apilable. Peso neto 5 kg. Otros colores disponibles, consulte el Departamento Comercial.

Stool for indoor and outdoor use, made of very strong resin reinforced with fiberglass. UV Protection. Stackable. Net weight 5 kg (11,02 lb). Other available colours, contact the Sales Department.

Tabouret pour une utilisation intérieure et extérieure, fabriqué en résine très résistante renforcée avec fibre de verre. Protection UV. Empilable. Poids net 5 kg. Autres couleurs disponibles, consultez le Département Commerciale.

● Chocolate | Chocolate | Chocolat

Siesta
exclusive



Jamaica Test Certificates: EN 16139 L1



W 40 cm
L 51 cm
H 108 cm
Hs 75 cm

W 15.75 in
L 20.08 in
H 42.52 in
Hs 29.53 in

STD units	Packaging dim. (cm)	M3/ pack	NW units (kg)	Units Container 20'	Units Container 40'	Units Container HC	Units Truck 70m ³	Units Truck 100m ³
4	43x64x133	0,36	5	288	732	732	840	840



KIBO

Taburete | Stool | Tabouret



Taburete de metal pintado con acabado antiguo. Apilable. Para uso interior y exterior.

Metal stool with antique cream finished. Stackable. For indoor and outdoor use.

Tabouret de métal peint avec finition ancienne. Empilable. Pour usage intérieur et extérieur.

● Crema | Cream | Crème

W 42 cm | W 16.53 in
L 42 cm | L 16.53 in
H 76 cm | H 29.92 in

STD units	Packaging dim. (cm)	M3/ pack	NW units (kg)	Units Container 20'	Units Container 40'	Units Container HC	Units Truck 70m ³	Units Truck 100m ³
4	44x44x112	0,05	-	900	1.875	1.875	-	-

KIBO

Taburete | Stool | Tabouret



Taburete bajo de metal pintado con acabado antiguo. Apilable. Para uso interior y exterior.

Metal short stool with antique cream finished. Stackable. For indoor and outdoor use.

Tabouret bas de métal peint avec finition ancienne. Empilable. Pour usage intérieur et extérieur.

● Crema | Cream | Crème

W 42 cm | W 16.53 in
L 42 cm | L 16.53 in
H 66 cm | H 25.98 in

STD units	Packaging dim. (cm)	M3/ pack	NW units (kg)	Units Container 20'	Units Container 40'	Units Container HC	Units Truck 70m ³	Units Truck 100m ³
4	44x44x105	0,05	-	1.000	2.080	2.080	-	-

JED

Taburete | Stool | Tabouret



Taburete para interior con asiento de PVC y espuma de color negro. Estructura de acero cromado. Taburete rotatorio con altura regulable con pistón de gas. Peso neto 6 kg.

Indoor stool with a PVC and foam seat in black colour. Chromed steel structure. Revolving stool with adjustable height with gas piston. Net weight 6 kg (13.23 lb).

Tabouret d'intérieur avec siège en PVC et mousse couleur noire. Structure en acier chromé. Tabouret pivotant avec manette de gaz pour régler la hauteur. Poids net 6 kg.

● Negro | Black | Noir

W 44 cm	W 17.32 in
L 43 cm	L 16.93 in
H 63 cm	H 24.80 in

STD units	Packaging dim. (cm)	M3/ pack	NW units (kg)	Units Container 20'	Units Container 40'	Units Container HC	Units Truck 70m ³	Units Truck 100m ³
2	55x43x27	0,06	6	720	1.800	1.800	2.160	2.160

HAL

Taburete | Stool | Tabouret



Taburete para interior con asiento de ABS de 10 mm. Estructura de acero cromado. Taburete rotatorio con altura regulable con pistón de gas. Peso neto 6 kg.

Indoor stool with ABS of 10 mm seat. Chromed steel structure. Revolving stool with adjustable height with gas piston. Net weight 6 kg (13.23 lb).

Tabouret d'intérieur avec siège en ABS de 10 mm. Structure en acier chromé. Tabouret pivotant avec manette de gaz pour régler la hauteur. Poids net 6 kg.

○ Blanco | White | Blanc

W 37 cm	W 17.32 in
L 37 cm	L 17.32 in
H 66 cm	H 24.80 in

STD units	Packaging dim. (cm)	M3/ pack	NW units (kg)	Units Container 20'	Units Container 40'	Units Container HC	Units Truck 70m ³	Units Truck 100m ³
2	45x18x41	0,03	6	720	1.800	1.800	2.120	2.120

ALEGRIA

Taburete | Stool | Tabouret



Taburete para uso interior y exterior de aluminio pintado por pulverización. Disponible en color blanco y negro. Peso neto 6 kg.

Stool for indoor and outdoor use in powder coated aluminum. Available in white and black. Net weight 6 kg (13.23 lb).

Tabouret pour usage intérieur et extérieur en aluminium peint par pulvérisation. Disponible en couleur blanche et noir. Poids net 6 kg.

○ Blanco | White | Blanc

● Negro | Black | Noir

W 52 cm	W 20.47 in
L 56 cm	L 22.05 in
H 104 cm	H 40.94 in

STD units	Packaging dim. (cm)	M3/ pack	NW units (kg)	Units Container 20'	Units Container 40'	Units Container HC	Units Truck 70m ³	Units Truck 100m ³
4	62x72x96	0,42	6	720	1.400	1.400	-	1.688

W: ancho / width / largeur. L: largo / length / longueur
H: altura / height / hauteur. Hs: altura asiento / seat height / hauteur du siège. Ha: altura brazo / arm height / hauteur du bras
Ø: diámetro / diameter / diamètre.

SILLONES Y SOFÁS

ARMCHAIRS AND SOFAS | FAUTEUILS ET CANAPES

SILLONES Y SOFÁS | ARMCHAIRS

AND SOFAS | FAUTEUILS ET CANAPES

Club Sillón	298
Club Sofá	299
Club mesa auxiliar	299
Bob Sofá	300
Bob Sillón	300
Bob mesa reposapiés	301
Hoop	302
Boomerang	304
Disk	305
Monaco sofá	306

Monaco sillón	306
Monaco cojín	307
Miami sillón	308
Miami sofá	308
Aruba sillón	309
California butaca	309
Box sillón	310
Box sofá	310
Box mesa	310
Apolo banco	311

CLUB

JOAN GASPAR

Sillón | Armchair | Fauteuil



- Blanco | White | Blanc
- Arena | Sand | Sable
- Chocolate | Chocolate | Chocolat
- Verde | Green | Vert

Sillón para uso interior y exterior, de polietileno rotomoldeado. Sistema de evacuación de agua. Protección contra rayos UV. Peso neto 19 kg. . Opcional: Cojín de algodón y poliéster de 5 cm de grosor en color beige para exterior.

Chair for indoor and outdoor use. Polyethylene rotomoulded seat. Water drainage system. UV protection. Net weight 19 kg. (41.89 lb). Optional: Cotton and polyester cushion 5 cm thickness in beige colour for outdoor use.

Fauteuil d'intérieur et extérieur. Siège en polyéthylène rotomoulé. Système d'évacuation d'eau. Protection contre les rayons UV. Poids net 19 kg. Optionnel: Coussin polyester et coton de 5 cm de grosseur de couleur beige pour extérieur.

W 90 cm	W 53,43 in
L 80 cm	L 31,5 in
H 66 cm	H 25,98 in

W: ancho / width / largeur. **L:** largo / length / longueur
H: altura / height / hauteur. **Hs:** altura asiento / seat height / hauteur du siège. **Ha:** altura brazo / arm height / hauteur du bras
Ø: diámetro / diameter / diamètre.

STD units	Packaging dim. (cm)	M3/ pack	NW units (kg)	Units Container 20'	Units Container 40'	Units Container HC	Units Truck 70m³	Units Truck 100m³
1	98,9x78,1x65,6	0,507	19	42	90	90	126	144



CLUB

JOAN GASPAR

Sofá | Sofa | Canapé



- Blanco | White | Blanc
- Arena | Sand | Sable
- Chocolate | Chocolate | Chocolat
- Verde | Green | Vert

Sofá para uso interior y exterior. Asiento de polietileno rotomoldeado. Sistema de evacuación de agua. Protección contra rayos UV. Peso neto 44 kg. Opcional: Cojín de algodón y poliéster de 5 cm de grosor en color beige para exterior.

Sofa for indoor and outdoor use. Polyethylene rotomoulded seat. Water drainage system. UV protection. Net weight 44 kg. (97 lb). Optional: Cotton and polyester cushion 5 cm thickness in beige colour for outdoor use.

Canapé d'intérieur et extérieur. Siège en polyéthylène rotomoulé. Système d'évacuation d'eau. Protection contre les rayons UV. Poids net 44 kg. Optionnel: Coussin polyester et coton de 5 cm de grosseur de couleur beige pour extérieur.

W 180 cm	W 70,87 in
L 80 cm	L 31,50 in
H 66 cm	H 25,98 in

STD units	Packaging dim. (cm)	M3/ pack	NW units (kg)	Units Container 20'	Units Container 40'	Units Container HC	Units Truck 70m³	Units Truck 100m³
1	180x78,3x65,6	0,924	44	21	45	45	63	72

CLUB

JOAN GASPAR

Mesa Auxiliar | Side Table | Table Auxiliaire



- Blanco | White | Blanc
- Arena | Sand | Sable
- Chocolate | Chocolate | Chocolat
- Verde | Green | Vert

Mesa-reposapiés para uso interior y exterior, de polietileno rotomoldeado. Protección contra rayos UV. Peso neto 6,8 kg. Opcional: tablero compacto fenólico.

Polyethylene rotomoulded table-footrest for indoor and outdoor use. UV protection. Net weight 6,8 kg. (14.99 lb). Optional: HPL table top.

Table repose-pied d'intérieur et extérieur, en polyéthylène rotomoulé. Protection contre les rayons UV. Poids net 6,8 kg. Optionnel: plateau résine phénolique.

W 65 cm	W 25,59 in
L 56 cm	L 22,05 in
H 34 cm	H 13,39 in

STD units	Packaging dim. (cm)	M3/ pack	NW units (kg)	Units Container 20'	Units Container 40'	Units Container HC	Units Truck 70m³	Units Truck 100m³
1	65,4x55,4x33,3	0,119	6,80	210	432	504	539	658

W: ancho / width / largeur. L: largo / length / longueur
H: altura / height / hauteur. Hs: altura asiento / seat height / hauteur du siège. Ha: altura brazo / arm height / hauteur du bras
Ø: diámetro / diameter / diamètre.

BOB

JOAN GASPAR

Sofá | Sofa | Canapé

○ Blanco | White | Blanc

● Negro | Black | Noir

● Rojo | Red | Rouge

W 113cm	W 44,49 in
L 72 cm	L 28,35 in
H 62,5 cm	H 24,61 in
Hs 37 cm	Hs 14,57 in



Sofá para uso interior y exterior. Asiento de polietileno rotomoldeado. Patas de aluminio pintado. Sistema de evacuación de agua. Protección contra rayos UV. Peso neto 23,50 kg.

Sofa for indoor and outdoor use. Polyethylene rotomoulded seat. Painted aluminium legs. Water drainage system. UV protection. Net weight 23,50 kg. (51.70 lb).

Canapé d'intérieur et extérieur. Siège en polyéthylène rotomoulé. Pieds en aluminium peint. Système d'évacuation d'eau. Protection contre les rayons UV. Poids net 23,50kg.

STD units	Packaging dim. (cm)	M3/ pack	NW units (kg)	Units Container 20'	Units Container 40'	Units Container HC	Units Truck 70m³	Units Truck 100m³
1	74x114,5x66	0,56	23,5	50	103	120	125	178

BOB

JOAN GASPAR

Sillón | Armchair | Fauteuil

○ Blanco | White | Blanc

● Negro | Black | Noir

● Rojo | Red | Rouge

W 56cm	W 22,05 in
L 72 cm	L 28,35 in
H 62,5 cm	H 24,61 in
Hs 37 cm	Hs 14,57 in



Sillón para uso interior y exterior. Asiento de polietileno rotomoldeado. Patas de aluminio pintado. Sistema de evacuación de agua. Protección contra rayos UV. Peso neto 9,24 kg.

Chair for indoor and outdoor use. Polyethylene rotomoulded seat. Painted aluminium legs. Water drainage system. UV protection. Net weight 9,24 kg. (20.32 lb).

Fauteuil d'intérieur et extérieur. Siège en polyéthylène rotomoulé. Pieds en aluminium peint. Système d'évacuation d'eau. Protection contre les rayons UV. Poids net 9,24 kg.

STD units	Packaging dim. (cm)	M3/ pack	NW units (kg)	Units Container 20'	Units Container 40'	Units Container HC	Units Truck 70m³	Units Truck 100m³
1	55x74x66	0,27	9,24	104	215	256	260	372

W: ancho / width / largeur. L: largo / length / longueur
 H: altura / height / hauteur. Hs: altura asiento / seat height / hauteur du siège. Ha: altura brazo / arm height / hauteur du bras
 Ø: diámetro / diameter / diamètre.

BOB

JOAN GASPAR

Mesa Reposapiés |
Table-footrest | Table Repose-pied



Mesa-reposapiés para uso interior y exterior. Sobre de polietileno rotomoldeado. Patas de aluminio pintado. Protección contra rayos UV. Peso neto 6,58 kg.

Table-footrest for indoor and outdoor use. Polyethylene rotomoulded table-footrest top. Painted aluminium legs. UV protection. Net weight 6,58 kg. (14.48 lb).

Table repose-pied d'intérieur et extérieur. Plateau en polyéthylène rotomoulé. Pieds en aluminium peint. Protection contre les rayons UV. Poids net 6,58 kg.

- Blanco | White | Blanc W 57 cm W 22,44 in
- Negro | Black | Noir L 57 cm L 22,44 in
- Rojo | Red | Rouge H 33 cm H 12,99 in

W: ancho / width / largeur. L: largo / length / longueur
H: altura / height / hauteur. Hs: altura asiento / seat height /
hauteur du siège. Ha: altura brazo / arm height / hauteur du bras
Ø: diámetro / diameter / diamètre.

STD units	Packaging dim. (cm)	M3/ pack	NW units (kg)	Units Container 20'	Units Container 40'	Units Container HC	Units Truck 70m ³	Units Truck 100m ³
1	58x58x32	0,11	6,58	260	539	640	650	929



HOOP

Bancada
Bench
Banc



HOOP RING

Bancada circular de polietileno rotomoldeado para uso interior y exterior. Protección contra rayos UV.

Polyethylene rotomoulded ring bench for indoor and outdoor use. UV protection.

Banc circulaire de polyéthylène rotomoulé pour usage intérieur et extérieur. Protection contre les rayons UV.

Ø 50 cm Ø 19,68 in
L 53,50 cm L 21,06 in



HOOP CURVE

Bancada semicircular de polietileno rotomoldeado para uso interior y exterior. Protección contra rayos UV.

Polyethylene rotomoulded curve bench for indoor and outdoor use. UV protection.

Banc demi-cercle de polyéthylène rotomoulé pour usage intérieur et extérieur. Protection contre les rayons UV.

W 50 cm W 19,68 in
L 53,50 cm L 21,06 in
H 80 cm H 31,49 in



HOOP STRAIGHT

Bancada lineal de polietileno rotomoldeado para uso interior y exterior. Protección contra rayos UV.

Polyethylene rotomoulded straight bench for indoor and outdoor use. UV protection.

Banc linéaire de polyéthylène rotomoulé pour usage intérieur et extérieur. Protection contre les rayons UV.

- Rojo | Red | Rouge
- Arena | Sand | Sable
- Naranja | Orange | Orange

W 50 cm W 19,68 in
L 53,50 cm L 21,06 in
H 80 cm H 31,49 in

W: ancho / width / largeur. L: largo / length / longueur
H: altura / height / hauteur. Hs: altura asiento / seat height / hauteur du siège. Ha: altura brazo / arm height / hauteur du bras
Ø: diámetro / diameter / diamètre.

STD units	Packaging dim. (cm)	M3/ pack	NW units (kg)	Units Container 20'	Units Container 40'	Units Container HC	Units Truck 70m³	Units Truck 100m³
RING	160x160x40	1,024	-	12	24	24	32	-
CURVE	273x100x40	1,092	-	16	32	32	40	-
STRAIGHT	200x40x40	0,32	-	44	96	96	120	-



BOOMERANG

VICENTE SOTO

Banco
Bench
Banc



Bancada en polietileno rotomoldeado.
Opción ignífuga consultar.

Bench in polyethylene rotomoulded.
Optional: Fire retardant version.

Fire-Banc en polyéthylène rotomoulé.
Consulter pour option ignifuge.

W 242 cm	W 95,28 in
L 84 cm	L 33,07 in
H 45 cm	H 17,72 in

- Rojo | Red | Rouge
- Blanco | White | Blanc
- Gris Oscuro | Dark Grey | Gris Foncé

 Certificados | Certificates | Certificats

Boomerang bench Test Certificates:
EN 16139 L1 / EN 581 PUBLIC



W: ancho / width / largeur. **L:** largo / length / longueur
H: altura / height / hauteur. **Hs:** altura asiento / seat height /
hauteur du siège. **Ha:** altura brazo / arm height / hauteur du bras
Ø: diámetro / diameter / diamètre.

STD units	Packaging dim. (cm)	M3/ pack	NW units (kg)	Units Container 20'	Units Container 40'	Units Container HC	Units Truck 70m³	Units Truck 100m³
1	250x115x100	2,875	43	8	16	16	20	-



DISK

JAVIER CUÑADO

Banco | Bench | Banc



DISK-1
Bancada básica | Bench | Banquette

H 50 cm | H 19,69 in
Ø 135 cm | Ø 53,15 in

DISK-4
Banco básico respaldo recto |
Straight backrest bench |
Banc avec dossier droit

H 95 cm | H 37,4 in
Ø 135 cm | Ø 53,15 in

DISK-2
Bancada media luna |
Half moon shape bench |
Banquette demi-lune

H 50 cm | H 19,69 in
Ø 135 cm | Ø 53,15 in

DISK-5
Banco básico respaldo curvo |
Curve backrest bench |
Banc avec dossier courbé

H 95 cm | H 95 cm
Ø 135 cm | Ø 135 cm

Banco en en polietileno rotomoldeado. Opción ignífuga consultar. Uso interior y exterior.

Bench in polyethylene rotomoulded. Optional: Fireretardant version. Indoor and outdoor use.

Fire-Banc en polyéthylène rotomoulé Consulter pour option ignifuge. Usage intérieur et extérieur.

* Consultar disponibilidad con el departamento Comercial

* Check availability with our Commercial Department

* Vérifiez la disponibilité avec notre département commercial

DISK-3
Bancada doble media luna |
Double half moon shape bench |
Banquette double demi-lune

H 50 cm | H 19,69 in
Ø 135 cm | Ø 53,15 in

DISK-6
Bancada doble media luna |
Double half moon shape bench |
Banquette double demi-lune

H 50 cm | H 19,69 in
Ø 135 cm | Ø 53,15 in

● Rojo | Red | Rouge

○ Blanco | White | Blanc

● Gris Oscuro | Dark Grey | Gris Foncé

W: ancho / width / largeur. L: largo / length / longueur
H: altura / height / hauteur. Hs: altura asiento / seat height /
hauteur du siège. Ha: altura brazo / arm height / hauteur du bras
Ø: diámetro / diameter / diamètre.

Ref.	STD units	Packaging dim. (cm)	M3/ pack	NW units (kg)	Units Container 20'	Units Container 40'
DISK-1	2	140x140x50	-	58	8	16
DISK-2	2	140x140x50	-	56	8	16
DISK-3	2	140x140x50	-	54	8	16
DISK-4	1	140x140x100	-	71	4	8
DISK-5	1	140x140x100	-	71	4	8
DISK-6	2	140x140x50	-	55	8	16

MONACO

Sofá | Sofa | Canapé



Sofá para uso interior y exterior diseñado para un montaje fácil. Fabricado en resina muy resistente y duradera reforzada con fibra de vidrio. Protección UV. Se puede desmontar. Otros colores disponibles, consulte el Departamento Comercial.

Sofa for indoor and outdoor use designed for easy self assembly. It is made of very strong and durable resin reinforced with fiberglass. UV protection. Can be disassembled. Other available colours, contact the Sales Department.

Canapé pour une utilisation intérieur et extérieur conçu pour être monter facilement. Fabriqué en résine très solide et durable renforcé avec fibre de verre. Peut être démonté. Protection UV. Autres couleurs disponibles, consultez le Département Commerciale.

W 140 cm	W 55.11 in
L 79 cm	L 31.10 in
H 79 cm	H 31.10 in
Hs 35 cm	Hs 13.77 in

● Chocolate | Chocolate | Chocolat



STD units	Packaging dim. (cm)	M3/ pack	NW units (kg)	Units Container 20'	Units Container 40'	Units Container HC	Units Truck 70m ³	Units Truck 100m ³
1x	125x77x36	0,347	27	80	195	195	230	-

MONACO

Sillón | Armchair | Fauteuil



Sillón para uso interior y exterior diseñado para un montaje fácil. Fabricado en resina muy resistente y duradera reforzada con fibra de vidrio. Protección UV. Se puede desmontar. Otros colores disponibles, consulte el Departamento Comercial.

Armchair for indoor and outdoor use designed for easy self assembly. It is made of very strong and durable resin reinforced with fiberglass. UV protection. Can be disassembled. Other available colours, contact the Sales Department.

Fauteuil pour une utilisation intérieur et extérieur conçu pour être monter facilement. Fabriqué en résine très solide et durable renforcé avec fibre de verre. Peut être démonté. Protection UV. Autres couleurs disponibles, consultez le Département Commerciale.

W 82 cm	W 32.28 in
L 79 cm	L 31.10 in
H 79 cm	H 31.10 in
Hs 35 cm	Hs 13.77 in

● Chocolate | Chocolate | Chocolat



STD units	Packaging dim. (cm)	M3/ pack	NW units (kg)	Units Container 20'	Units Container 40'	Units Container HC	Units Truck 70m ³	Units Truck 100m ³
2x	125x77x49	0,472	18	120	300	300	350	-

MONACO

Cojín | Cushion | Coussin

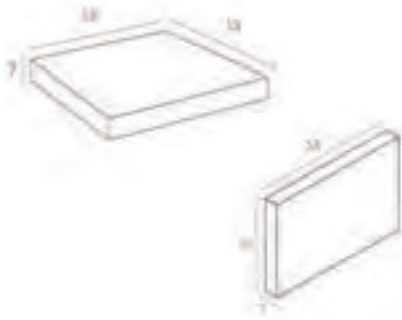

Cojín de poliéster de 7 cm de grosor en color beige pardo.

Polyester cushion 7 cm thickness in brown beige colour.

Coussin polyester de 7 cm de grosseur de couleur beige foncé.

Siesta

W 58 cm	W 22.83 in	W 58 cm	W 22.83 in
L 58 cm	L 22.83 in	L 7 cm	L 2.75 in
H 7 cm	H 2.75 in	H 39 cm	H 15.35 in

W: ancho / width / largeur. L: largo / length / longueur
 H: altura / height / hauteur. Hs: altura asiento / seat height /
 hauteur du siège. Ha: altura brazo / arm height / hauteur du bras
 Ø: diámetro / diameter / diamètre.

STD units	Packaging dim. (cm)	M3/ pack	NW units (kg)	Units Container 20'	Units Container 40'	Units Container HC	Units Truck 70m ³	Units Truck 100m ³
4x	60x60x28	0,1	1.340	-	-	-	-	-
4x	60x39x28	0,063	0.760	-	-	-	-	-



MIAMI

Sillón | Armchair | Fauteuil



Miami Test
Certificates:
EN 15373 L2



● Chocolate |
Chocolate |
Chocolat



□ Cojín Miami Pardo
Miami Pardo armchair cushion
Coussin de fauteuil Miami Pardo



Sillón apilable para uso interior y exterior fabricada en resina muy resistente y duradera reforzada con fibra de vidrio. Protección UV. Otros colores disponibles, consulte el Departamento Comercial.

Stackable armchair for indoor and outdoor use made of very strong and durable resin reinforced with fiberglass. UV protection. Other available colours, contact the Sales Department.

Fauteuil empilable pour usage intérieur et extérieur fabriqué en résine très solide et durable renforcé avec fibre de verre. Protection UV. Autres couleurs disponibles, consultez le Département Commerciale.

Cojín de poliéster de 5 cm de grosor en color beige pardo.

Polyester cushion 5 cm thickness in brown beige colour.

Coussin polyester de 5 cm de grosseur de couleur beige foncé.

W 72 cm	W 28.35 in
L 76 cm	L 29.62 in
H 89 cm	H 35.04 in
Hs 38 cm	Hs 14.96 in
Ha 67 cm	Ha 26.37 in

STD units	Packaging dim. (cm)	M3/ pack	NW units (kg)	Units Container 20'	Units Container 40'	Units Container HC	Units Truck 70m ³	Units Truck 100m ³
1	73,7x60,7x96,9	0,43	9,25	50	128	128	-	144
10	72x114x246	2,019	9,25	144	320	320	432	432

MIAMI

Sofá | Sofa | Sofa



Miami Test
Certificates:
EN 15373 L2



● Chocolate |
Chocolate |
Chocolat



□ Cojín Miami Pardo
Miami Pardo armchair cushion
Coussin de fauteuil Miami Pardo

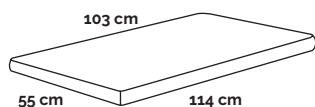

Sofá apilable para uso interior y exterior fabricada en resina muy resistente y duradera reforzada con fibra de vidrio. Protección UV. Otros colores disponibles, consulte el Departamento Comercial.

Stackable sofa for indoor and outdoor use made of very strong and durable resin reinforced with fiberglass. UV protection. Other available colours, contact the Sales Department.

Canapé empilable pour une utilisation intérieur et extérieur fabriqué en résine très solide et durable renforcé avec fibre de verre. Protection UV. Autres couleurs disponibles, consultez le Département Commerciale.

Cojín de poliéster de 5 cm de grosor en color beige pardo.

Polyester cushion 5 cm thickness in brown beige colour.

Coussin polyester de 5 cm de grosseur de couleur beige foncé.

W 128 cm	W 50.39 in
L 77 cm	L 30.31 in
H 89 cm	H 35.04 in
Hs 38 cm	Hs 14.96 in

STD units	Packaging dim. (cm)	M3/ pack	NW units (kg)	Units Container 20'	Units Container 40'	Units Container HC	Units Truck 70m ³	Units Truck 100m ³
1	80x77x140	0,862	12,5	20	45	45	-	80
10	128x114x246	3,58	12,5	90	180	180	240	240

W: ancho / width / largeur. L: largo / length / longueur
H: altura / height / hauteur. Hs: altura asiento / seat height / hauteur du siège. Ha: altura brazo / arm height / hauteur du bras
Ø: diámetro / diameter / diamètre.

ARUBA

Sillón | Armchair | Fauteuil



Aruba Test
Certificates:
EN 581 PUBLIC



● Chocolate | Chocolate | Chocolat

○ Blanco | White | Blanc



□ Cojin Butaca Aruba Rattan
Aruba Rattan armchair cushion
Cousin de fauteuil Aruba Rattan

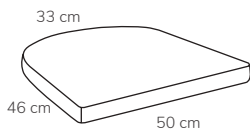

Sillón apilable para uso interior y exterior fabricado en resina muy resistente y duradera reforzada con fibra de vidrio. Protección UV. Otros colores disponibles, consulte el Departamento Comercial.

Stackable armchair for indoor and outdoor use made of very strong and durable resin reinforced with fiberglass. UV protection. Other available colours, contact the Sales Department.

Fauteuil empilable pour usage intérieur et extérieur fabriqué en résine très solide et durable renforcé avec fibre de verre. Protection UV. Autres couleurs disponibles, consultez le Département Commerciale.

Cojín de poliéster de 5 cm de grosor en color beige pardo.

Polyester cushion 5 cm thickness in brown beige colour.

Cousin polyester de 5 cm de grosseur de couleur beige foncé.

W 74 cm	W 29.13 in
L 75 cm	L 29.53 in
H 80 cm	H 31.50 in
Hs 44 cm	Hs 17.32 in

● Beige Pardo | Brown Beige | Beige Foncé

STD units	Packaging dim. (cm)	M3/ pack	NW units (kg)	Units Container 20'	Units Container 40'	Units Container HC	Units Truck 70m ³	Units Truck 100m ³
1	73,7x60,7x96,9	0,433	7,5	150	340	340	-	380
20	77x75x223	1,29	7,5	480	1.020	1.020	1.140	1.140

CALIFORNIA

Butaca | Armchair | Fauteuil



California Test
Certificates:
EN 581 PUBLIC



● Chocolate | Chocolate | Chocolat



□ Cojin Butaca California
California armchair cushion
Cousin de fauteuil California

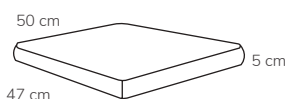

Butaca para uso interior y exterior fabricada en resina muy resistente y reforzada con fibra de vidrio. Protección UV. Montaje muy fácil. Peso neto 10 kg. Otros colores disponibles, consulte el Departamento Comercial.

Armchair for indoor and outdoor use, made of very strong resin reinforced with fiberglass. UV Protection. Easy self assembling. Net weight 10 kg (22,05 lb). Other available colours, contact the Sales Department.

Fauteuil pour usage intérieur et extérieur, fabriqué en résine très résistante renforcée avec fibre de verre. Protection UV. Montage très facile. Poids net 10 kg. Autres couleurs disponibles, consultez le Département Commerciale.

Cojín de poliéster de 5 cm de grosor en color beige pardo.

Polyester cushion 5 cm thickness in brown beige colour.

Cousin polyester de 5 cm de grosseur de couleur beige foncé.

W 59 cm	W 23.22 in
L 63 cm	L 24.8 in
H 90 cm	H 35.43 in
Hs 42 cm	Hs 16.53 in

● Beige Pardo | Brown Beige | Beige Foncé

STD units	Packaging dim. (cm)	M3/ pack	NW units (kg)	Units Container 20'	Units Container 40'	Units Container HC	Units Truck 70m ³	Units Truck 100m ³
2	43x52x92	0,20	10	256	676	676	724	724

W: ancho / width / largeur. L: largo / length / longueur
H: altura / height / hauteur. Hs: altura asiento / seat height / hauteur du siège. Ha: altura brazo / arm height / hauteur du bras
Ø: diámetro / diameter / diamètre.

BOX

Sofá | Sofa | Canapé



Siesta
exclusive



Sofa Box-Test
Certificates:
EN 581
PUBLIC



Sofá apilable de polipropileno, para uso interior y exterior. Sistema de evacuación de agua. Protección UV. Otros colores disponibles, consulte el Departamento Comercial.

Stacking sofa in polypropylene, for indoor and outdoor use. Water drainage system. UV protection. Other available colours, contact the Sales Department.

Sofa empilable en polypropylène pour usage intérieur ou extérieur. Système d'évacuation d'eau. Protection UV. Autres couleurs disponibles, consultez le Département Commercial.

○ Blanco | White | Blanc

● Gris | Grey | Gris

● Negro | Black | Noir

W 138 cm	W 54.33in
L 62 cm	L 24.41 in
H 80 cm	H 31.50 in
Hs 44 cm	Hs 17.32 in

STD units	Packaging dim. (cm)	M3/ pack	NW units (kg)	Units Container 20'	Units Container 40'	Units Container HC	Units Truck 70m³	Units Truck 100m³
1	80x70x140	0,862	14	50	112	112	-	128
4	139x63x215	1,88	14	-	324	324	384	384

BOX

Sillón | Armchair | Fauteuil



Siesta
exclusive



Miami Test
Certificates:
EN 15373 L2

W: ancho / width / largeur. L: largo / length / longueur

H: altura / height / hauteur. Hs: altura asiento / seat height / hauteur du siège. Ha: altura brazo / arm height / hauteur du bras

Ø: diámetro / diameter / diamètre.

Sillón apilable de polipropileno. Resistente y estable. Para uso interior y exterior. Peso neto 7 kg. Sistema de evacuación de agua. Protección U.V. Otros colores disponibles, consulte al Departamento Comercial.

Stackable armchair of polypropylene. Strong and stable. For outdoor and indoor use. Net weight 7 kg (15.43 lb). Water drainage system. UV protection. Other available colours, contact the Sales Department.

Fauteuil empilable en polypropylène. Fort et stable. Pour usage intérieur et extérieur. Poids net 7 kg. Système d'évacuation d'eau. Protection

○ Blanco | White | Blanc

● Gris | Grey | Gris

● Negro | Black | Noir

W 57 cm	W 22.44 in
L 53 cm	L 20.87 in
H 84 cm	H 33.07 in
Hs 45 cm	Hs 17.72 in



Apilable
Stackable | Empilable

STD units	Packaging dim. (cm)	M3/ pack	NW units (kg)	Units Container 20'	Units Container 40'	Units Container HC	Units Truck 70m³	Units Truck 100m³
1	73,7x60,7x96,6	0,43	7	90	194	194	-	214
4	66x58x114	0,44	7	276	576	576	640	640

BOX

Mesa | Table | Table



Siesta
exclusive

○ Blanco | White | Blanc

● Negro | Black | Noir

● Gris | Grey | Gris

Mesa auxiliar apilable de polipropileno, para uso interior y exterior. Protección UV.

Auxiliary stacking table in polypropylene, for indoor and outdoor use. UV protection.

Table auxiliaire empilable en polypropylène pour usage intérieur ou extérieur. Protection UV.



Table Box Test
Certificates:
EN 15373 L2

W 43 cm
L 70 cm
H 50 cm

W 16.93 in
L 27.56 in
H 19.69 in



STD units	Packaging dim. (cm)	M3/ pack	NW units (kg)	Units Container 20'	Units Container 40'	Units Container HC	Units Truck 70m³	Units Truck 100m³
1	60x60x90	0,36	4	180	380	380	-	408
4	77x57x73	0,32	4	360	720	720	-	1.104

APOLO

Banco | Bench | Banc

Banco para exterior de 150 cm con lamas de PVC. Peso neto 16,24 kg.

Bench for outdoors of 150 cm with PVC slats. Net weight 16,24 kg (35.80 lb).

Banc pour extérieur de 150 cm avec lattes de PVC. Poids net 16,24 kg.



○ Blanco | White | Blanc

W 75 cm	W 29.53 in
L 150 cm	L 59.06 in
H 75 cm	H 29.53 in

STD units	Packaging dim. (cm)	M3/ pack	NW units (kg)	Units Container 20'	Units Container 40'	Units Container HC	Units Truck 70m ³	Units Truck 100m ³
1	77x14x153	0,16	16,24	150	340	340	450	425
15	153x77x253	2,98	16,24	-	-	-	450	510

SETS

SETS

Monaco	314
Bruno	315
Miami	316
Orient	317
Jack	317
Cloud	317

MONACO

Set | Set | Set



Set compuesto por 1 sofá doble, 2 sillones, 1 mesa y 8 cojines. Conjunto de cojines de poliéster con 7 cm de grosor en color beige pardo incluidos en el Set.

Set consists of 1 double sofa, 2 armchairs, 1 table and 8 cushions. Polyester cushions 7 cm thick brown beige included in the Set.

Set composé de 1 canapé deux places, 2 fauteuils, 1 table et 8 coussins. Coussins en polyester de 7 cm de grosseur beige foncé inclus avec le Set.

● Chocolate | Chocolate | Chocolat

Siesta
MULTI-COLOR



Otros colores y combinaciones disponibles bajo pedido y plazo de entrega. Consultar Departamento Comercial.

Other colours and combinations available upon request, delivery time varies. Ask the Sales Department.

Autres couleurs et combinaisons disponibles sur commande et délai de livraison. Consulter le Département Commercial.

W: ancho / width / largeur. L: largo / length / longueur
H: altura / height / hauteur. Hs: altura asiento / seat height / hauteur du siège. Ha: altura brazo / arm height / hauteur du bras
Ø: diámetro / diameter / diamètre.

STD units	Packaging dim. (cm)	M3/ pack	NW units (kg)	Units Container 20'	Units Container 40'	Units Container HC	Units Trayler 70m ²	Units Truck 100m ³
1 set	-	-	79	30	65	65	80	-

BRUNO

Butaca | Armchair | Fauteuil



Butaca de ratán sintético redondo en color marrón con estructura interna de aluminio. Cojines desenfundables, con cremallera, en poliéster color gris oscuro.

Synthetic round rattan armchair in brown colour with internal aluminium structure. Removable cushions with zipper in polyester of dark grey colour.

Fauteuil en ronds osier synthétique couleur marron avec structure interne en aluminium. Coussin en polyester avec crémaillère déhoussable de couleur gris foncé.

- Gris Oscuro | Dark Grey | Gris Foncé
- Cojín Gris Oscuro | Cushion Dark Grey | Coussin Gris Foncé

Detalle del color |
Color detail |
Détail de la couleur



W 86 cm	W 33.86 in
L 95,5 cm	L 37.60 in
H 63,5 cm	H 25.00 in

STD units	Packaging dim. (cm)	M3/ pack	NW units (kg)	Units Container 20'	Units Container 40'	Units Container HC	Units Trayler 70m ³	Units Truck 100m ³
1	160x88x68	0,96	15,6	56	112	124	96	156

BRUNO

Mesa Auxiliar | Side Table | Table Auxiliaire



Mesa auxiliar de ratán sintético redondo en color marrón con estructura interna de aluminio. Sobre de cristal templado transparente de 5 mm.

Synthetic round rattan side table in brown colour with internal aluminium frame. Table top of 5 mm transparent tempered glass.

Table auxiliaire en ronds rattan synthétique, couleur gris anthracite avec structure en aluminium. Plateau en verre trempé transparent de 5 mm.

- Gris Oscuro | Dark Grey | Gris Foncé

Detalle del color |
Color detail |
Détail de la couleur



W 50 cm	W 19.69 in
L 100 cm	L 39.37 in
H 40 cm	H 15.75 in

STD units	Packaging dim. (cm)	M3/ pack	NW units (kg)	Units Container 20'	Units Container 40'	Units Container HC	Units Trayler 70m ³	Units Truck 100m ³
1	102x52x43	0,23	12,7	108	225	225	260	348

BRUNO

Sofa | Sofa | Canapé



Sillón para uso exterior. Inyectado en polipropileno. Apilable. Peso neto: 3 kg. Protección UV.

Armchair for outdoor use. Injected with polypropylene. Stackable. Net weight 3 kg (6.61 lb). UV Protection.

Fauteuil pour extérieur. Injectée en propylène. Empilable. Poids net 3 kg. Protection UV.

- Gris Oscuro | Dark Grey | Gris Foncé
- Cojín Gris Oscuro | Cushion Dark Grey | Coussin Gris Foncé

Detalle del color |
Color detail |
Détail de la couleur



W 86 cm	W 33.86 in
L 153 cm	L 60.24 in
H 63.5 cm	H 25.00 in

W: ancho / width / largeur. L: largo / length / longueur
H: altura / height / hauteur. Hs: altura asiento / seat height / hauteur du siège. Ha: altura brazo / arm height / hauteur du bras
Ø: diámetro / diameter / diamètre.

STD units	Packaging dim. (cm)	M3/ pack	NW units (kg)	Units Container 20'	Units Container 40'	Units Container HC	Units Trayler 70m ³	Units Truck 100m ³
1	110x115x85	1,07	26	-	150	-	180	-

MIAMI

Set | Sel | Set



● Chocolate | Chocolate | Chocolat

Siesta
EXCLUSIVE

Otros colores disponibles bajo pedido y plazo de entrega. Consultar Departamento Comercial.

Other colours available upon request, delivery time varies. Ask the Sales Department.

Autres couleurs disponibles sur commande et délai de livraison. Consulter le Département Commercial.

Set compuesto por 1 sofá doble, 2 sillones, 1 mesa, 2 mesas auxiliares y 3 cojines. Conjunto de cojines de poliéster con 5 cm de grosor en color beige incluidos en el Set.

Set consists of 1 double sofa, 2 armchairs, 1 table, 2 side tables and 3 cushions. Polyester cushions 5 cm thick brown beige included in the Set.

Set composé de 1 canapé deux places, 2 fauteuils, 1 table, 2 tables auxiliaires et 3 coussins. Coussins en polyester de 5 cm de grosseur beige foncé inclus avec le Set.



ORIENT

Set | Set | Set



Set compuesto por 1 sofá triple, 2 sillones, 1 mesa y 8 cojines. Conjunto de cojines de poliéster. Estructura en aluminio y PE de 8 mm de grosor.

Set consists of 1 triple sofa, 2 armchairs, 1 table and 8 cushions. Polyester cushions. 8 mm thick aluminum alloy structure

Set composé de 1 canapé deux places, 2 fauteuils, 1 table et 8 coussins. Coussins en polyester de 8 mm de grosseur beige foncé inclus avec le Set.

● Gris | Grey | Gris

Detalle del color |
Color detail |
Détail de la couleur



STD units	Packaging dim. (cm)	M3/ pack	NW units (kg)	Units Container 20'	Units Container 40'	Units Container HC	Units Trayler 70m³	Units Truck 100m³
1	203x105x99,5 +113x73x44	-	-	-	24	24	-	-

JACK

Set | Set | Set



Set Modular. Varias combinaciones posibles.

Modular set. Several possible combinations.

Set Modular. Plusieurs combinaisons possibles.

W 155 cm	W 61.02 in
L 88 cm	L 34.65 in
H 67 cm	H 26.38 in



W: ancho / width / largeur. L: largo / length / longueur
H: altura / height / hauteur. Hs: altura asiento / seat height / hauteur du siège. Ha: altura brazo / arm height / hauteur du bras
Ø: diámetro / diameter / diamètre.

● Beige | Beige | Beige

● Cojín Gris | Grey Cushion | Coussin Gris

Detalle del color |
Color detail |
Détail de la couleur



CLOUD

Set | Set | Set



Resol presenta el exclusivo Set Cloud, fruto de la innovación de ofrecer un acabado interior de gran calidad pensado para ambientes exteriores.

Resol presents the exclusive Dream Cloud, fruit of the innovation of offering a high-quality indoor finishing thought for outdoor environments.

Resol présente l'exclusif Set Cloud, comme résultat de l'innovation d'offrir une finition de haute qualité d'intérieur pensée pour environnements extérieurs.

○ Blanco | White | Blanc



STAMSKIN
Serge Ferrari

TUMBONAS Y MESAS AUXILIARES

SUN LOUNGERS AND SIDE TABLES |
BAIN DE SOLEIL ET TABLE AUXILIAIRE

TUMBONAS Y MESAS

AUXILIARES | SUN LOUNGERS AND

SIDE TABLES | BAIN DE SOLEIL ET TABLE

AUXILIAIRE

Marina Beach	320
Marina Club	322
Pacific	326
Costa Brava	327
Master	327
Cubic	328
Shio	328
Comfort	328
Sand	329
Sand plegable	329
Fiji	330
Fiji cojín	330

Tender colchoneta	331
Coral funda	331
Cubic mesa	332
Shio mesa	332
Andorra	333
Monaco	333

MARINA BEACH

Tumbona | Sunlounger | Chaise Longue



	Azul Blue
	Blanca White
	Arena Sand
	Marfil Ivory
	Arena Sand Gris Oscuro Dark Grey
	Azul Blue
	Plata Silver
	Arena Sand
	Wengé Wenge
	Arena Sand
	Blanca White

Marina Test
Certificates:
EN 581 Public



(Tejido | Fabric
 Estructura | Structure)



Tumbona apilable con caja de seguridad incorporada al chasis para guardar objetos de forma segura. Se cierra con una tapa plástica muy resistente y hermética, y con un candado de acero inoxidable.

La Marina Beach está disponible con tejido Beach, de 740gr/m² fabricado con hilo de poliéster plastificado con protección ultravioleta y termosoldado para una máxima resistencia. La tumbona Marina Beach también está disponible con el tejido Club.

Stackable sun lounger with safety box built into the chassis, in which objects can be stored safely. It closes with a very resistant and hermetic plastic cover, and with a stainless steel padlock.

Marina Beach is available with Beach fabric of 740gr/m² made with plasticized polyester yarn with ultraviolet protection and thermowelded for maximum resistance. The Marina Beach sun lounger is also available in Club fabric.

Bain de soleil empilable avec boîtier de sécurité incorporé dans la structure afin de garder les effets personnels en toute sécurité. Fermeture au moyen d'un couvercle très résistant et hermétique, fourni avec un cadenas d'acier inoxydable.

La Marina Beach est disponible avec textile Beach de 740gr/m² fabriqué en fil de polyester plastifié doté d'une protection UV et termosoudé pour maximum de résistance. Le bain de soleil Marina Beach est également disponible avec le tissu Club.

W 73 cm	W 28.74 in
L 190 cm	L 74.80 in
H 35 cm	H 13.78 in

W: ancho / width / largeur. L: largo / length / longueur
H: altura / height / hauteur. Hs: altura asiento / seat height /
hauteur du siège. Ha: altura brazo / arm height / hauteur du bras
Ø: diámetro / diameter / diamètre.

STD units	Packaging dim. (cm)	M3/ pack	NW units (kg)	Units Container 20'	Units Container 40'	Units Container HC	Units Truck 70m ³	Units Truck 100m ³
25	191x75x222	3,18	10,65	225	450	450	525	625



MARINA CLUB

Tumbona | Sunlounger | Chaise Longue



Tumbona apilable con estructura de polipropileno y fibra de vidrio. Textilene de 850 gr/m2, termosoldado, para mayor resistencia, y trama y urdimbre de doble hilo. Protección UV. Ruedas en patas traseras y tacos antideslizantes en las delanteras y traseras. Incorpora posavasos. Peso neto 10,65 kg. Reclinable en 4 posiciones.

Stackable sunlounger. Polypropylene and fiberglass frame. Textilene 850 gr/m2, thermal bonding, to improve resistance, double linen weft and warp. UV protection. Wheels under back legs and non-slip end-plates under front and back legs. Glass holder. Net weight: 10.65 kg (23.43 lb). Four-position reclining sunlounger.

Chaise longue empilable avec structure en polypropylène et fibre de verre. Textilène de 850 gr/m2, termosoudé pour une résistance meilleure, et double chaîne et du fil de trame et ourdir. Pieds arrière munis de roues et pieds avant et arrière munis de patins antidérapants, avec repose-verres. Poids net 10,65 kg. 4 positions du dossier

Marina Test
Certificates:
EN 581 Public



W 73 cm	W 28.74 in
L 190 cm	L 74.80 in
H 35 cm	H 13.78 in

Estructura | Structure | Structure

● Wenge | Wenge | Wenge

○ Blanco | White | Blanc

● Marfil | Ivory | Ivoire

● Gris Oscuro | Dark Grey | Gris Foncé

● Plateado | Silver | Argent

W: ancho / width / largeur. L: largo / length / longueur
H: altura / height / hauteur. Hs: altura asiento / seat height /
hauteur du siège. Ha: altura brazo / arm height / hauteur du bras
Ø: diámetro / diameter / diamètre.

STD units	Packaging dim. (cm)	M3/ pack	NW units (kg)	Units Container 20'	Units Container 40'	Units Container HC	Units Truck 70m³	Units Truck 100m³
25	191x75x222	3,18	10,65	225	450	450	525	625

COLORES COLORS COULEURS

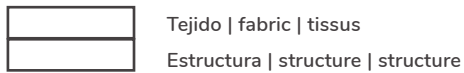

Tejido | fabric | tissu

Estructura | structure | structure



Azul | blue | bleu

Blanco | white | blanc



Verde | green | vert

Blanco | white | blanc



Amarillo | yellow | jaune

Blanco | white | blanc



Naranja | orange | orange

Blanco | white | blanc



Blanco/azul | white/blue | blanc/bleu

Blanco | white | blanc



Beige | Beige | beige

Blanco | white | blanc



Blue jeans | blue jeans | blue jeans

Blanco | white | blanc



Beige | Beige | beige

Marfil | Ivory | ivoire



Beige | Beige | beige

Gris oscuro | dark grey | gris foncé



Blue jeans | blue jeans | blue jeans

Plata | silver | argent



Chocolate | chocolate | chocolat

Wengé | wenge | wenge



Amplia gama de colores.

Wide range of colors.

Large plage de couleurs.

—

Personalizable.

Customised logos.

Possibilité de

personnalisation.



Ruedas en patas traseras.

Wheels under back legs.

Pieds arrières avec roulettes.



NOVEDAD:

Recambios de textilenes disponibles.

Textilenes spare parts available.

Textilènes de rechange disponibles.



**Tumbona
monobloc
Extremadamente
resistente
Protección UV
Ligera**

Monoblock
sunlounger
Extremely strong
UV protection
Lightweight

Bain de soleil
monobloc
Résistance extrême
Protection UV
Légère



Tacos antideslizantes en todas las patas.

Non-slip end-plates under front and back legs.

Pieds avant et arrière munis de patins antidérapant.

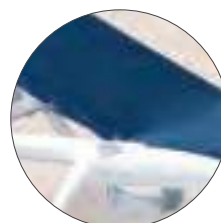

Posavasos.

Glass holder.

Support de verre.

DISEÑO INTELIGENTE SMART DESIGN CONCEPTION INTELLIGENTE

Máxima apilabilidad en mínimo espacio (25 unidades).

Maximum Stackability in minimum space (25 units).

Empilable au maximum dans un espace minimum (25 unités).

—

4 posiciones (incluye posición extraplana ideal para estar tumbado boca abajo).

Four-position reclining sunlounger (including flat position).

4 positions du dossier (inclus position extraplate).







PACIFIC

Tumbona | Sunlounger | Chaiselongue



Tumbona con estructura en resina reforzada con fibra de vidrio y textilene 500 gr/m², termosoldado para mayor resistencia. Apilable, reclinable en 5 posiciones, con tacos antideslizantes y ruedas pequeñas. Otros colores disponibles, consulte al Departamento Comercial. Recambios de textilenes disponibles.

Sunlounger with tubular frame in resin reinforced with glass fiber and textilene 500 gr/m², thermal bonding to improve resistance. Stackable, back reclining in 5 positions, with non-slip feet and small wheels. Other available colours, contact the Sales Department. Textilenes spare parts available.

Chaise longue avec structure en résine et fibre de verre renforcée et. Empilable et textilène de 500 gr/m², termosoudé pour une meilleure résistance. 5 positions du dossier. Pieds antidérapants et petites roues. Autres couleurs disponibles, consultez le Département Commerciale. Textilènes de rechange disponibles.

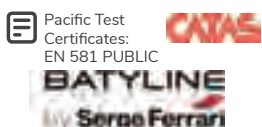

W 68 cm
L 193 cm
H 26 cm

W 26.77 in
L 75.98 in
H 10.24 in

● Azul/Blanco | Blue/White | Bleu/Blanc

● Negro/Gris Oscuro | Black/Dark Grey | Noir/Gris Foncé

● Beige/Blanco | Beige/White | Beige/Blanc

STD units	Packaging dim. (cm)	M3/ pack	NW units (kg)	Units Container 20'	Units Container 40'	Units Container HC	Units Truck 70m ³	Units Truck 100m ³
18	70x194x254	3,44	16,5	135	324	324	-	400



COSTA BRAVA

Tumbona | Sunlounger | Chaise Longue



Incluye posavasos.
Includes glassholder.
Comprend support de verre.

 Apilable
Stackable | Empilable

W: ancho / width / largeur. L: largo / length / longueur
H: altura / height / hauteur. Hs: altura asiento / seat height /
hauteur du siège. Ha: altura brazo / arm height / hauteur du bras
Ø: diámetro / diameter / diamètre.

STD units	Packaging dim. (cm)	M3/ pack	NW units (kg)	Units Container 20'	Units Container 40'	Units Container HC	Units Truck 70m ³	Units Truck 100m ³
2	63x50x185	0,58	8,65	72	144	144	-	-
33	185x70x221	2,86	8,65	297	594	594	693	825

Tumbona apilable fija con estructura de polipropileno. Peso neto 8,65 kg. Protección UV.

Stackable sunlounger. Polypropylene frame. Net weight 8,65 kg (19.07 lb). UV Protection.

Chaise longue empilable fixe avec structure de polypropylène. Poids net 8,65 kg. Protection UV.

Blanco | White | Blanc

Antracita | Anthracite | Anthracite

W 63 cm	W 24.80 in
L 188 cm	L 74.02 in
H 47 cm	H 18.50 in

MASTER

Tumbona | Sunlounger | Chaise Longue



Blanco | White | Blanc

Antracita | Black | Noir

Verde Oscuro | Dark Green | Vert Foncé



Incluye posavasos.
Includes glassholder.
Comprend support de verre.

Opcional:
Tapa de caja de seguridad
Optional: Safe cover.
Optionnel: Couverture de sécurité.

W 63 cm	W 24.80 in
L 188 cm	L 74.02 in
H 47 cm	H 18.50 in

STD units	Packaging dim. (cm)	M3/ pack	NW units (kg)	Units Container 20'	Units Container 40'	Units Container HC	Units Truck 70m ³	Units Truck 100m ³
2	63x50x185	0,58	10,25	72	144	144	-	-
33	185x70x221	2,86	10,25	297	594	594	693	825

Tumbona apilable con estructura de polipropileno. Con alojamiento posavasos o móvil en el lado derecho y caja en el lado izquierdo con tapa opcional. Ruedas en patas traseras. Peso neto 10,25 kg. Reclinable 5 posiciones. Protección UV.

Polypropylene frame stackable sunlounger. With space to hold drinking glasses or to store a mobile phone on the right side, and a box on the left side with optional top. Wheels under back legs. Net weight 10,25 kg (22.60 lb). Five-position reclining sunlounger. UV Protection.

Chaise longue empilable avec structure de polypropylène. Avec un emplacement porte-gobelet ou téléphone portable sur la partie droite et vide poche sur la partie gauche avec couvercle optionnel. Pieds arrière munis de roues. Poids net 10,25 kg. 5 positions de dossier. Protection UV.

CUBIC

Tumbona | Sunlounger | Chaise Longue



● Gris Claro | Light Grey | Gris Clair

Cubic Test Certificates: BS EN 581 Public



Tumbona de aluminio pintado por pulverización en color gris claro y textilene de color negro. Embellecedor de madera ultratech. Ruedas de 22 cm., de aluminio cubiertas de goma. Peso neto: 10,20 kg. 5 posiciones.

Powder-coated aluminium sunlounger in light grey and textilene in black. Trimming of ultratech wood. 22 cm wheels of rubber covered aluminium. Net weight: 10,20 kg (22.44 lb). 5 positions.

Chaise longue en aluminium peint par pulvérisation de couleur gris clair et textilène noir. Revêtement en bois ultratech. Roues de 22 cm. en aluminium recouvertes de gomme. Poids net: 10,20 kg. 5 positions.

W 64 cm	W 25.20 in
L 192 cm	L 75.59 in
H 83 cm	H 32.68 in
Hs 34 cm	Hs 13.39 in

STD units	Packaging dim. (cm)	M3/ pack	NW units (kg)	Units Container 20'	Units Container 40'	Units Container HC	Units Truck 70m ³	Units Truck 100m ³
2	196x76x37	0,54	12	108	216	242	261	372

SHIO

Tumbona | Sunlounger | Chaise Longue



○ Blanco | White | Blanc

W 64 cm	W 25.20 in
L 192 cm	L 75.59 in
H 83 cm	H 32.68 in
Hs 34 cm	Hs 13.39 in

Tumbona de aluminio pintado por pulverización en color blanco y textilene de color blanco. Embellecedor de madera ultratech. Ruedas de 22 cm, de aluminio cubiertas de goma. Peso neto: 10,20 kg. 5 posiciones.

Powder-coated aluminium sunlounger in white and textilene in white. Trimming of ultratech wood. 22 cm wheels of rubber covered aluminium. Net weight: 10,20 kg (22.44 lb). 5 positions.

Chaise longue en aluminium peint par pulvérisation de couleur blanche et textilène blanc. Revêtement en ultratech. Roues de 22 cm. en aluminium recouvertes de gomme. Poids net: 10,20 kg. 5 positions.

STD units	Packaging dim. (cm)	M3/ pack	NW units (kg)	Units Container 20'	Units Container 40'	Units Container HC	Units Truck 70m ³	Units Truck 100m ³
2	196x76x37	0,54	10,2	108	216	242	260	-

COMFORT

Tumbona | Sunlounger | Chaise Longue



● Gris Claro | Light Grey | Gris Clair

Cubic Test Certificates: UNE EN 581



Tumbona apilable de aluminio pintado por pulverización en gris oscuro con textilene gris claro. Peso neto: 8,70 kg. Reclinable en 6 posiciones.

Power-coated aluminium stackable sunlounger in dark grey. Light grey textilene. Net weight: 8,70 kg (19.14 lb). Six-position reclining sunlounger.

Chaise longue empilable en aluminium peint par pulvérisation couleur gris foncé. Poids net: 8,70 kg. 6 positions de dossier.

W 65 cm	W 25.59 in
L 193 cm	L 75.98 in
H 86 cm	H 33.86 in
Hs 34 cm	Hs 13.39 in

STD units	Packaging dim. (cm)	M3/ pack	NW units (kg)	Units Container 20'	Units Container 40'	Units Container HC	Units Truck 70m ³	Units Truck 100m ³
23	205x68x213	3,09	8,7	161	345	345	391	460

SAND

Tumbona | Sunlounger | Chaise Longue



Tumbona apilable de aluminio pintado por pulverización en blanco con textilene blanco. Peso neto: 8,3 kg. Reclinable en 5 posiciones.

Power-coated aluminium stackable sunlounger in white. White textilene. Net weight: 8,3 kg (18.30 lb). 5 position reclining sunlounger.

Chaise longue empilable en aluminium peint par pulvérisation couleur blanc avec textilène blanc. Poids net: 8,3 kg. 5 positions de dossier.

Blanco | White | Blanc

W 66 cm	W 25.98 in
L 200 cm	L 78.74 in
H 40 cm	H 15.75 in



W: ancho / width / largeur. **L:** largo / length / longueur
H: altura / height / hauteur. **Hs:** altura asiento / seat height / hauteur du siège. **Ha:** altura brazo / arm height / hauteur du bras
Ø: diámetro / diameter / diamètre.

STD units	Packaging dim. (cm)	M3/ pack	NW units (kg)	Units Container 20'	Units Container 40'	Units Container HC	Units Truck 70m³	Units Truck 100m³
23	205x68x213	3,09	8,3	184	391	460	437	506

SAND

Tumbona Plegable | Folding Sunlounger | Chaise Longue



Tumbona plegable de aluminio pintado por pulverización en blanco con textilene blanco o gris. Peso neto: 4,26 kg. Reclinable en 4 posiciones.

Power-coated aluminium stackable sunlounger in white. White or grey textilene. Net weight: 4,26 kg (9.39 lb). 4 position reclining sunlounger.

Chaise longue pliable en aluminium peint par pulvérisation couleur blanc avec textilène blanc ou gris. Poids net: 4,26 kg. 4 positions de dossier

W 61 cm	W 24.02 in
L 103 cm	L 40.55 in
H 80 cm	H 31.50 in

Estructura | Structure | Structure

Blanco | White | Blanc

✘ Textilene | Textilene | Textilène

Blanco | White | Blanc

Gris | Grey | Gris

Sand Test Certificates: EN 581 Public



STD units	Packaging dim. (cm)	M3/ pack	NW units (kg)	Units Container 20'	Units Container 40'	Units Container HC	Units Truck 70m³	Units Truck 100m³
4	205x68x213	3,09	4,26	680	1.400	1.400	2.000	2.400

FIJI

Tumbona | Sunlounger | Chaiselongue

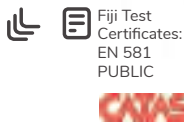

● Chocolate | Chocolate | Chocolat



W 73 cm | W 28.74 in
L 187 cm | L 73.62 in
H 44 cm | H 17.32 in

STD units	Packaging dim. (cm)	M3/ pack	NW units (kg)	Units Container 20'	Units Container 40'	Units Container HC	Units Truck 70m ³	Units Truck 100m ³
18	75x193x245	3,54	14	-	-	324	420	420

Tumbona apilable. Respaldo de cinco posiciones, ruedas ocultas y gomas antideslizantes. Fabricada en resina muy resistente a la intemperie y duradera. Protección Rayos UV, que asegura que el color no se desvanezca. Sin estructura metálica. Para uso exterior. Otros colores disponibles, consulte el Departamento Comercial.

Stackable sunlounger. Five position reclining sunlounger. Hidden wheels and anti-slippery rubbers. Made of very strong and durable resin, fiberglass reinforced. UV protection, which ensures that the color does not to fade. Whitout metallic structure. For outdoor use. Other available colours, contact the Sales Department.

Chaise longue empilable pour utilisation extérieure. Roues invisibles et aoutchoucs anti-glissant. Fabriquée en résine très solide et durable, renforcée avec fibre de verre. Empilable. Protection UV. Sans métal. Autres couleurs disponibles, consultez le Département Commerciale.

FIJI

Cojín| Cushion | Coussin



● Beige | Beige | Beige



W 59 cm | W 23.22 in
L 186 cm | L 73.22 in
H 5 cm | H 1.96 in

STD units	Packaging dim. (cm)	M3/ pack	NW units (kg)	Units Container 20'	Units Container 40'	Units Container HC	Units Truck 70m ³	Units Truck 100m ³
5	186x60x27	0,301	2,04	-	-	-	-	-

Cojín de poliéster de 5 cm de grosor en color beige pardo.

Polyester cushion 5 cm thickness in brown beige colour.

Coussin polyester de 5 cm de grosseur de couleur beige foncé.

W: ancho / width / largeur. L: largo / length / longueur
H: altura / height / hauteur. Hs: altura asiento / seat height / hauteur du siège. Ha: altura brazo / arm height / hauteur du bras
Ø: diámetro / diameter / diamètre.

NEW

TENDER

Colchoneta | Mattress | Matelas



Colchoneta fabricada en hilo de poliéster plastificado resistente a los rayos ultravioleta de 500gr/m2 de peso. En su interior hay goma espuma de densidad 30kg/m3 recubierta de PVC para evitar que absorba la humedad.

Mattress made of plasticized plast-coated, breathable polyester, with UVA resistance. It weights 500gr/m2. Inside there is a foam rubber of 30kg/m3 density, covered with PVC to prevent it from absorbing moisture.

Matelas fabriqué en fil de polyester plastifié résistant aux rayons ultraviolets de 500gr/m2. À l'intérieur, une mousse de densité 30kg/m3 recouvert de PVC évite l'absorption d'humidité.

● Azul | Blue | Bleu

● Beige | Beige | Beige

Respaldo / Backrest

W 54,5 cm
L 60 cm
H 6 cm

W 21 in
L 23 in
H 2 in

Asiento / Seat

W 54,5 cm
L 127 cm
H 6 cm

W 21 in
L 50 in
H 2 in

STD units	Packaging dim. (cm)	M3/ pack	NW units (kg)	Units Container 20'	Units Container 40'	Units Container HC	Units Truck 70m ³	Units Truck 100m ³
5	187x457x35	-	4	400	-	840	-	-

NEW

CORAL

Funda protectora para tumbonas
Protective cover for sunloungers
Housse protectrice pour bain de soleil

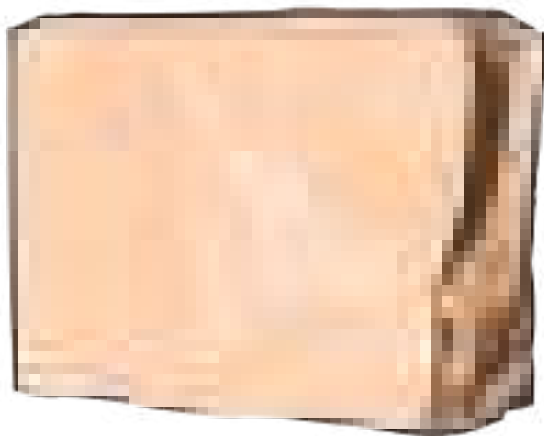

Protege las tumbonas de las inclemencias del tiempo cuando no están en uso. Es muy fácil de colocar. Tejido sintético sin cremallera y con doble costura, resistente a los rayos ultravioleta. Se suministra con bolsa individual dentro de cajas de cartón de cinco unidades.

It protects sun loungers from inclement weather when they are not in use. It is very easy to place. Synthetic fabric without zip and double sewing, resistant to ultraviolet rays. It is supplied with an individual bag inside cardboard boxes of five units.

Protection des bains de soleil du mauvais temps quand ils ne sont pas utilisés. Très facile à installer. Tissu synthétique sans fermeture et équipé d'une couture double, résistant aux rayons ultraviolets. Fourni avec un sachet individuel dans une caisse carton qui contient 5 unités.

W 82 cm
L 215 cm
H 150 cm

W 32 in
L 85 in
H 59 in

● Beige | Beige | Beige

CUBIC

Mesa Auxiliar | Side Table | Table Auxiliaire



Mesa auxiliar de aluminio pintado por pulverización en color gris claro.

Powder-coated aluminium auxiliary table in light grey.

Table auxiliaire en aluminium peint par pulvérisation de couleur gris clair.

● Gris Claro | Light Grey | Gris Clair

W 50 cm	W 19.68 in
L 50 cm	L 19.68 in
H 45 cm	H 17.72 in

STD units	Packaging dim. (cm)	M3/ pack	NW units (kg)	Units Container 20'	Units Container 40'	Units Container HC	Units Trayler 70m ²	Units Truck 100m ³
1	55x55x12	0,03	3,90	1.000	2.000	2.241	2.414	3.448

SHIO

Mesa Auxiliar | Side Table | Table Auxiliaire



Mesa para uso interior y exterior de aluminio pintado por pulverización en color blanco.

White powder-coated aluminium table for indoor and outdoor use.

Table pour usage intérieur ou extérieur en aluminium peint par pulvérisation de couleur blanc.

○ Blanco | White | Blanc

W 50 cm	W 19.68 in
L 50 cm	L 19.68 in
H 45 cm	H 17.72 in

W: ancho / width / largeur. L: largo / length / longueur
 H: altura / height / hauteur. Hs: altura asiento / seat height / hauteur du siège. Ha: altura brazo / arm height / hauteur du bras
 Ø: diámetro / diameter / diamètre.

STD units	Packaging dim. (cm)	M3/ pack	NW units (kg)	Units Container 20'	Units Container 40'	Units Container HC	Units Trayler 70m ²	Units Truck 100m ³
1	55x55x12	0,03	3,9	1.000	2.000	2.241	2.414	3.448

ANDORRA

Mesa Auxiliar | Side Table | Table Auxiliaire

AndorraTest
Certificates:
EN 581



Mesa auxiliar de polipropileno.
Protección UV. Patas embutidas.
Peso neto 2,14 kg.

Polypropylene side table. UV
Protection. Pressure-fitted legs.
Net weight 2.14 kg (4.71 lb).

Table auxiliaire en polypropylène.
Protection UV. Pieds emboîtés.
Poids net 2,14 kg.

- Blanco | White | Blanc
- Antracita | Anthracite | Anthracite
- Verde Oscuro | Dark Green | Vert Foncé

W 47 cm	W 18.50 in
L 47 cm	L 18.50 in
H 41 cm	H 16.14 in

STD units	Packaging dim. (cm)	M3/ pack	NW units (kg)	Units Container 20'	Units Container 40'	Units Container HC	Units Trayler 70m ³	Units Truck 100m ³
6	48x48x52	0,12	2,14	1.320	2.640	3.300	3.696	-
120	120x100x215	2,58	2,14	-	2.400	-	-	-
136	120x100x235	2,82	2,82	-	-	-	3.536	-

MONACO

Mesa Auxiliar | Side Table | Table Auxiliaire



Monaco Test
Certificates:
EN 581 PUBLIC / en
16139 L1



Mesa auxiliar monobloc de polipropileno.
Protección UV. Apilable. Peso neto
1,65 kg.

Polypropylene monobloc side table.
UV protection. Stackable. Net weight:
1,65 kg (3,63 lb).

Table auxiliaire monobloc en
polypropylène avec. Protection
UV. Empilable. Poids net: 1,65 kg.

- Blanco | White | Blanc
- Antracita | Anthracite | Anthracite

W 50 cm	W 19.69 in
L 50 cm	L 19.69 in
H 45 cm	H 17.72 in

Apilable
Stackable | Empilable

W: ancho / width / largeur. L: largo / length / longueur
H: altura / height / hauteur. Hs: altura asiento / seat height /
hauteur du siège. Ha: altura brazo / arm height / hauteur du bras
Ø: diámetro / diameter / diamètre.

STD units	Packaging dim. (cm)	M3/ pack	NW units (kg)	Units Container 20'	Units Container 40'	Units Container HC	Units Trayler 70m ³	Units Truck 100m ³
5	61x61x62	0,23	1,60	405	855	1.140	1.330	1.550
16	80x60x120	0,58	1,60	832	1.760	1.760	2.144	2.560
82	120x60x213	1,53	1,60	902	2.050	2.050	2.706	2.952

PARASOLES

PARASOLS | PARASOLS

PARASOLES | PARASOLS |

PARASOLS

Costa	336
A2	337
A2 base	337
LA2	338
A1	339
I1	340
AM1	341

M2	342
A3	343
Siro 15 pie	344
Siro 35 pie	344
Flexo pie	345
Stone 25 pie	345
Strong 150 pie	345
Marquesina	346
Brisa	347

COSTA

Parasol | Parasol | Parasol



● Beige | Beige | Beige

Ø 200 cm | Ø 78.74 in
H 250 cm | H 98.42 in

W: ancho / width / largeur. **L:** largo / length / longueur

H: altura / height / hauteur. **Hs:** altura asiento / seat height / hauteur du siège. **Ha:** altura brazo / arm height / hauteur du bras

Ø: diámetro / diameter / diamètre.

Parasol de playa de 2 metros de diámetro, con mástil de acero inoxidable graduable, 8 varillas de fibra de vidrio macizas y piezas plásticas de poliamida. Tejido acrílico tintado a la masa de 235 g/m². También apto para piscinas montado en pie Siro-35.

Beach parasol of 2 meters of diameter, with adjustable central pole made in stainless Steel. 8 Ribs in solid fiberglass and plastic components in polyamide. Acrylic fabric solution dyed of 235 g/m². Installed in base Siro-35 is also suitable for swimming pools.

Parasol de plage de 2 mètres de diamètre, avec mât en acier inoxydable ajustable, 8 baleines en fibre de verre massif et pièces en polyamide. Toile de 235 g/m² en acrylique teinté dans la masse. Monté sur le pied Siro-35, il est également apte pour piscine.

STD units	Packaging dim. (cm)	M3/ pack	NW units (kg)	Units Container 20'	Units Container 40'	Units Container HC	Units Truck 70m ³	Units Truck 100m ³
1	154x14x14x	0,03	5,8	957	1.939	1.939	1.988	-



A2

Parasol | Parasol | Parasol



Parasol cuadrado de 4 x 4 m de aluminio pintado por pulverización en color blanco para uso profesional. Mástil estriado de aluminio de una sola pieza de Ø 78 mm. y 2,50 mm de grosor. 8 varillas de aluminio de 22 x 35 mm y 1,50 mm de grosor. Piña y colante de aluminio inyectado. Tela de poliéster de 300 g/m2, sin "flap", con chimenea. (Incluye funda con cremallera). Recambio de tela disponible. Incluye base en cruz de aluminio de 98 x 107 cm. Para bases empotrables ver la ref. Base empotrable para A2. No incluye pie.

Square 4 x 4 m powder-coated aluminium parasol in white for professional use. Grooved aluminium pole of one sole piece with ø 78 mm and a thickness of 2.50 mm. 8 aluminium ribs 22 x 35 mm with a 1.50 mm thickness. Injected aluminium hub and runner. 300 g/m2 polyester fabric without "flap", with airshaft. (Includes cover with zipper). Fabric replacement available. Includes a 98 x 107 cm aluminium cross base. For bases that can be fitted into the ground, see ref. Base that can be fitted into the ground for A2. Base not included.

Parasol carré de 4 x 4 m en aluminium peint par pulvérisation de couleur blanche pour usage professionnel. Mât strié en aluminium d'une seule pièce de ø 78 mm. x 2,50 mm. de grosseur. 8 baleines en aluminium de 22 x 35 mm et 1,50 mm de grosseur. Moyeu et tête de mât en aluminium injecté. Tissu en polyester de 300 g/m2., sans «flap», avec cheminée. (Inclus housse avec fermeture éclair). Rechange de tissu disponible. Base en forme de croix en aluminium de 98 x 107 cm, incluse. Et pour les bases encastrables, voir la réf. Base encastrable pour A2. Pied non inclus.

● Beige | Beige | Beige

W 410 cm | W 161.42 in
L 410 cm | L 161.42 in
H 412 cm | H 162.20 in

STD units	Packaging dim. (cm)	M3/ pack	NW units (kg)	Units Container 20'	Units Container 40'	Units Container HC	Units Truck 70m³	Units Truck 100m³
1	396x28x26	0,29	31	56	112	125	135	-

A2

Base Empotrable | Fitted Base | Base Encastrable



Base empotrable de acero galvanizado y con pletina de fijación inoxidable AISI 316 y tapa de aluminio pintado epoxy blanco. Apto para mástiles ø 78 mm.

Base of galvanised steel, that can be fitted into the ground, and with an AISI 316 fixing plate and an epoxy painted aluminium lid in white. Suitable for ø 78 mm poles.

Base encastrable en acier galvanisé et platine de fixation inoxydable AISI 316 et couvercle en aluminium peint en époxy blanc. Pour mâts de ø 78 mm.

Ø 7 cm | Ø 2.76 in
H 40 cm | H 15.75 in



W: ancho / width / largeur. L: largo / length / longueur
H: altura / height / hauteur. Hs: altura asiento / seat height / hauteur du siège. Ha: altura brazo / arm height / hauteur du bras
Ø: diámetro / diameter / diamètre.

STD units	Packaging dim. (cm)	M3/ pack	NW units (kg)	Units Container 20'	Units Container 40'	Units Container HC	Units Truck 70m³	Units Truck 100m³
1	16x16x20	0,02	10	1.400	-	-	-	-

LA2

Parasol
Parasol
Parasol



● Taupe | Taupe | Taupe

● Beige | Beige | Beige

Ø 350 cm | Ø 137.80 in
H 245 cm | H 96.46 in

Parasol de pie lateral de diámetro 3,5 m, 8 varillas de aluminio de 17x25 mm. Mástil de aluminio con apertura por manivela, 6,50x9,50 cm. Tela de poliéster de 250 g/m², sin "flap", con chimenea. Función de inclinación de la cubierta a derecha e izquierda. Giro con rotación de 360º. No incluye pie.

Powder-coated aluminium lateral umbrella of 3.5 m diameter. Eight ribs 17,25 mm. Aluminium pole 2,56x3.74 in opening with crank, 250 gr/m² polyester fabric without "flap", with airshaft. Cover tilt, turning left and right. Turning to 360º rotating. Base not included.

Parasol avec pied latéral de diamètre 3,5 mm, 8 baleines en aluminium de 17x25 mm. Mât de 6,50x9,50 cm en aluminium avec ouverture par manivelle. Tissu en polyester de 250 gr/m² sans "flap", avec cheminée. Fonction d'inclinaison du toit à droite et à gauche. Giro 360º de rotation. Pied non inclus.

Compatible con base Stone 25. (mínimo 4 unidades) y STRONG 25. Ver en pág 345

Goes with Stone 25. (minimum 4 units). See on page 345

Compatible avec Stone 25. (minimum 4 unités). Voir page 345

W: ancho / width / largeur. L: largo / length / longueur
H: altura / height / hauteur. Hs: altura asiento / seat height /
hauteur du siège. Ha: altura brazo / arm height / hauteur du bras
Ø: diámetro / diameter / diamètre.

STD units	Packaging dim. (cm)	M3/ pack	NW units (kg)	Units Container 20'	Units Container 40'	Units Container HC	Units Truck 70m ³	Units Truck 100m ³
1	42x258x17	0,19	26	130	260	300	350	-

A1

Parasol
Parasol
Parasol



- Beige | Beige | Beige
- Verde Oscuro | Dark Green | Vert Foncé
- Burdeos | Burgundy | Bordeaux

W 300 cm	W 118.11 in
L 300 cm	L 118.11 in
H 270 cm	H 106.30 in

Parasol cuadrado 3 x 3 m. de doble polea. Mástil de aluminio de una sola pieza lacado blanco de ø 58 mm. 8 varillas de aluminio de 18 x 28 mm. Gramaje tela 300 g/m2. Poliester. No incluye pie.

Square aluminium parasol 3 x 3 m with double pulley. Single piece white lacquer-coated aluminium pole ø 58 mm. 8 aluminium ribs 18 x 28 mm. Fabric weight 300 g/m2. Polyester fiber. Base not included.

Parasol carré 3 x 3 m, double poulie. Mât en aluminium laqué blanc ø 58 mm. 8 baleines aluminium 18 x 28 mm. Grammage de la toile 300 g/m2. Polyester. Pied non inclus.

Compatible con base Siro 35. Ver en pág 344
Goes with Siro 35. See on page 344
Compatible avec Siro 35. Voir page 344

W: ancho / width / largeur. **L:** largo / length / longueur
H: altura / height / hauteur. **Hs:** altura asiento / seat height / hauteur du siège. **Ha:** altura brazo / arm height / hauteur du bras
Ø: diámetro / diameter / diamètre.

STD units	Packaging dim. (cm)	M3/ pack	NW units (kg)	Units Container 20'	Units Container 40'	Units Container HC	Units Truck 70m³	Units Truck 100m³
1	20x20x270	0,08	12,5	316	484	770	792	1.132

1

Parasol
Parasol
Parasol



● **Antracita | Antracite | Antracite**

W 300 cm	W 118.11 in
L 300 cm	L 118.11 in
H 260 cm	H 102.36 in

Parasol cuadrado 3 x 3 m. de doble polea. Mástil de aluminio de una sola pieza ø 45 mm. 8 varillas de aluminio de 18 x 28 mm. Gramaje tela 300 g/m². Poliéster. Aluminio con efecto inox. No incluye pie.

Square aluminium parasol 3 x 3 m with double pulley. Single piece aluminium pole ø 45 mm. 8 aluminium ribs 18 x 28 mm. Fabric weight 300 g/m². Polyester fiber. Aluminum with stainless steel effect. Base not included.

Parasol carré 3 x 3 m, double poulie. Mât en aluminium ø 45 mm. 8 baleines aluminium 18 x 28 mm. Grammage de la toile 300 g/m². Polyester. Aluminium avec un effet d'acier inoxydable. Pied non inclus.

Compatible con base Siro 35. Ver en pág 344
Goes with Siro 35. See on page 344
Compatible avec Siro 35. Voir page 344

W: ancho / width / largeur. L: largo / length / longueur
H: altura / height / hauteur. Hs: altura asiento / seat height / hauteur du siège. Ha: altura brazo / arm height / hauteur du bras
Ø: diámetro / diameter / diamètre.

STD units	Packaging dim. (cm)	M3/ pack	NW units (kg)	Units Container 20'	Units Container 40'	Units Container HC	Units Truck 70m ³	Units Truck 100m ³
1	20x265x20	0,10	10,5	242	484	572	528	572

AM1

Parasol
Parasol
Parasol



● Taupe | Taupe | Taupe

W 300 cm	W 118.11 in
L 300 cm	L 118.11 in
H 270 cm	H 106.30 in

Parasol cuadrado de 3 x 3 m de aluminio y altura 2,70 m. Mástil de 58 mm de diámetro con acabado color madera. 8 varillas de aluminio de 18 x 28 mm y acabado color madera. Tela de poliéster de 300 g/m2 sin "flap" con chimenea. Sistema de polea de plástico. No incluye pie.

Square aluminium umbrella 3 x 3 m and 2.7 m high. Pole of 58 mm of diameter in wood colour finish. Eight ribs 18 x 28 mm in wood colour finish. 300 g/m2 polyester fabric in without "flap", with airshaft. Plastic pole system. Base not included.

Parasol carré de 3 x 3 m en aluminium et hauteur 2,70 m. Mât de 58 mm de diamètre avec finition couleur bois. 8 baleines en aluminium de 18 x 28 mm et finition couleur bois. Tissu en polyester de 300 g/m2 couleur "flap" avec cheminée. Système de poulie en matière plastique. Pied non inclus.

Compatible con base Flexo. Ver en pág 344

Goes with Flexo. See on page 344

Compatible avec Flexo. Voir page 344

W: ancho / width / largeur. L: largo / length / longueur
H: altura / height / hauteur. Hs: altura asiento / seat height / hauteur du siège. Ha: altura brazo / arm height / hauteur du bras
Ø: diámetro / diameter / diamètre.

STD units	Packaging dim. (cm)	M3/ pack	NW units (kg)	Units Container 20'	Units Container 40'	Units Container HC	Units Truck 70m³	Units Truck 100m³
1	20x20x270	0,08	12,5	242	484	572	528	572

M2

Parasol
Parasol
Parasol



● Marfil | Ivory | Ivoire

● Verde Oscuro | Dark Green |
Vert Foncé

Ø 300 cm | Ø 118.11 in
H 270 cm | H 106.30 in

Parasol redondo de ø 3 m con doble polea. Mástil de madera tropical barnizada de dos piezas de ø 48 mm. 8 varillas de madera de 17x 22 mm. Gramaje tela 270 g/m². Poliester. No incluye pie. Peso neto 6,5 kg.

Round parasol, ø 3 m with double pulley and two-piece hardwood varnished pole ø 48 mm. 8 wooden ribs 17 x 22 mm. Fabric weight 270 g/m². Polyester fiber. Base not included. Net weight 6,5 kg (14.33 lb).

Parasol rond ø 3 m, double poulie. Mât bois vernis, deux pièces ø 48 mm. 8 baleines bois 17 x 22 mm. Grammage de la toile 270 g/m². Polyester. Pied non inclus. Poids net 6,5 kg.

Compatible con base Siro 35. Ver en pág 344

Goes with Siro 35. See on page 344

Compatible avec Siro 35. Voir page 344

W: ancho / width / largeur. **L:** largo / length / longueur
H: altura / height / hauteur. **Hs:** altura asiento / seat height /
hauteur du siège. **Ha:** altura brazo / arm height / hauteur du bras
Ø: diámetro / diameter / diamètre.

STD units	Packaging dim. (cm)	M3/ pack	NW units (kg)	Units Container 20'	Units Container 40'	Units Container HC	Units Truck 70m ³	Units Truck 100m ³
1	15x15x158	0,04	6,5	800	1.600	1.900	1.955	2.794

A3

Parasol
Parasol
Parasol



● Beige | Beige | Beige

W 300 cm	W 78.74 in
L 300 cm	L 78.74 in
H 240 cm	H 94.49 in

Parasol cuadrado 2 x 2 m, de doble polea. Mástil de aluminio de una sola pieza lacado blanco de Ø 48 mm. 8 varillas de aluminio de 18 x 28 mm. Gramaje de la tela 300 g/m³. Poliéster. No incluye pie. Peso neto 4,50 kg.

Square aluminium parasol 2 x 2 m, with double pulley. Single piece white lacquer-coated aluminium pole Ø 48 mm. 8 aluminium ribs 18 x 28 mm. Fabric weight 300 g/m³. Polyester fiber. Base not included. Net weight 4,50 kg (9.92 lb).

Parasol carré 2 x 2 m, double pule. Mât aluminium laqué blanc Ø 48 mm. 8 baleines en aluminium 18 x 28 mm. Grammage de la toile 300 g/m³. Polyester. N'inclut pas le pied. Poids net 4,50 kg.

Compatible con base Siro 35. Ver en pág 344

Goes with Siro 35. See on page 344

Compatible avec Siro 35. Voir page 344

W: ancho / width / largeur. L: largo / length / longueur
H: altura / height / hauteur. Hs: altura asiento / seat height /
hauteur du siège. Ha: altura brazo / arm height / hauteur du bras
Ø: diámetro / diameter / diamètre.

STD units	Packaging dim. (cm)	M3/ pack	NW units (kg)	Units Container 20'	Units Container 40'	Units Container HC	Units Truck 70m ³	Units Truck 100m ³
1	245x17x17	0,07	4,5	-	1.670	-	1.569	-

SIRO-15

Pie | Base | Pied



Pie de parasol negro de 15 kg. Base de cemento con estructura de acero y aro de caucho protector. Base de diámetro de 48 cm. Apto para mástiles de \varnothing 30 mm, \varnothing 35 mm y \varnothing 38 mm. Peso neto 15 kg.

Black parasol base 15 kg (33.00 lb) \varnothing 48 concrete base with steel structure and protective rubber ring. Base diameter 48 cm. Suitable for \varnothing 30 mm, \varnothing 35 mm and \varnothing 38 mm poles. Net weight 15 kg (33.07 lb).

Pied de parasol noir de 15 kg. Embase en ciment avec structure en acier et anneau de protection en caoutchouc. Embase de 48 cm de diamètre. Pour mâts de \varnothing 30 mm, \varnothing 35 mm et \varnothing 38 mm. Poids net 15 kg.

● Negro | Black | Noir

\varnothing 41,5cm | \varnothing 16.34 in
H 60 cm | H 23.62 in

STD units	Packaging dim. (cm)	M3/ pack	NW units (kg)	Units Container 20'	Units Container 40'	Units Container HC	Units Truck 70m ²	Units Truck 100m ²
1	48x11x54	0,03	15	900	-	-	-	-



SIRO-35

Pie | Base | Pied



Pie de parasol negro de 35 kg. Base de cemento con estructura de acero y caucho con ruedas. Base de diámetro 50 cm. Apto para mástiles \varnothing 38 mm, \varnothing 48 mm y \varnothing 58 mm. 35 kg.

Black parasol base 35 kg (77.00 lb). Concrete base with steel structure and protective rubber ring with wheels. Base diameter 50 cm. Suitable for \varnothing 38 mm, \varnothing 48 mm and \varnothing 58 mm poles. Net weight 35 kg (77.16 lb).

Pied de parasol noir de 35 kg. Base en ciment avec structure en Asier et anneau de protection en caoutchouc avec roues. Embase de 50 cm de diamètre. Pour mâts de \varnothing 38 mm, \varnothing 48 mm et \varnothing 58 mm. 35 kg.

● Negro | Black | Noir

\varnothing 50 cm | \varnothing 19.69 in
H 60 cm | H 23.62 in

STD units	Packaging dim. (cm)	M3/ pack	NW units (kg)	Units Container 20'	Units Container 40'	Units Container HC	Units Truck 70m ²	Units Truck 100m ²
1	60x16x57	0,05	35	488	-	-	-	-

W: ancho / width / largeur. L: largo / length / longueur
H: altura / height / hauteur. Hs: altura asiento / seat height / hauteur du siège. Ha: altura brazo / arm height / hauteur du bras
 \varnothing : diámetro / diameter / diamètre.



FLEXO

Pie | Base | Pied



W: ancho / width / largeur. **L:** largo / length / longueur
H: altura / height / hauteur. **Hs:** altura asiento / seat height /
 hauteur du siège. **Ha:** altura brazo / arm height / hauteur du bras
Ø: diámetro / diameter / diamètre.

Pie de hierro de 35 kg. Con agujeros para sujeción en el suelo. Diámetro igual que el Siro 35, apto para parasoles de Ø 38, Ø 48 y Ø 58.

Iron base 35 kg (77.16 lb). With fastening holes to fix on the ground. Same diameter than Siro 35, for Ø 38, Ø 48 and Ø 58 parasols.

Pied en fer 35 kg. Avec trous de fixation dans le sol. Égal au diamètre Siro 35, approprié pour parasols Ø 38, Ø 48 et Ø 58.

● Negro | Black | Noir

W 49,5 cm	W 19.49 in
L 49,5 cm	L 19.49 in
H 1,8 cm	H 0.71 in

STD units	Packaging dim. (cm)	M3/ pack	NW units (kg)	Units Container 20'	Units Container 40'	Units Container HC	Units Truck 70m ³	Units Truck 100m ³
1	58x51x9	0,02	35	520	-	-	-	-

STONE 25

Peso | Block | Poids



W: ancho / width / largeur. **L:** largo / length / longueur
H: altura / height / hauteur. **Hs:** altura asiento / seat height /
 hauteur du siège. **Ha:** altura brazo / arm height / hauteur du bras
Ø: diámetro / diameter / diamètre.

Peso de cemento negro de 25 kg para base en cruz de parasol. Apto para mástiles ø 38 mm, ø 48 mm y ø 58 mm.

25 kg (55lb) cement black block for cross-type parasol base. Suitable for ø 38 mm, ø 48 mm and ø 58 mm.

Poids noir de ciment de 25 kg pour base de parasol en forme de croix. Pour mâts de ø 38 mm, ø 48 mm et ø 58 mm.

● Negro | Black | Noir

W 47 cm	W 18.50 in
L 47 cm	L 18.50 in
H 5,5 cm	H 2.17 in

STD units	Packaging dim. (cm)	M3/ pack	NW units (kg)	Units Container 20'	Units Container 40'	Units Container HC	Units Truck 70m ³	Units Truck 100m ³
1	50x50x8,50	0,13	25	162	378	420	464	480

STRONG 150

Pie Rellenable | Refillable Base |
 Pied Replissable



W: ancho / width / largeur. **L:** largo / length / longueur
H: altura / height / hauteur. **Hs:** altura asiento / seat height /
 hauteur du siège. **Ha:** altura brazo / arm height / hauteur du bras
Ø: diámetro / diameter / diamètre.

Pie apto para parasoles A2 y LA2. Cuando está relleno de arena o agua su peso es de 120 kg. Para cambiar el pie de ubicación con el parasol instalado se recomienda no realizar la maniobra de forma brusca para evitar que las ruedas se rompan.

Base fit for A2 and LA2 parasols. When it's full of sand or water, its weight is 264,55 lb. To move the base with parasol installed it is recommended not to perform the maneuver abruptly to prevent wheels breakage.

Pied compatible pour parasols A2 et LA2. Lorsqu'il est rempli avec du sable ou de l'eau, son poids est de 120 kg. Pour changer l'emplacement du parasol installé, il est recommandé de ne pas effectuer la manoeuvre brusquement afin d'éviter la rupture des roues.

● Negro | Black | Noir

W 84 cm	W 33.07 in
L 84 cm	L 33.07 in
H 18 cm	H 7.09 in

STD units	Packaging dim. (cm)	M3/ pack	NW units (kg)	Units Container 20'	Units Container 40'	Units Container HC	Units Truck 70m ³	Units Truck 100m ³
1	86x86x21	0,15	16	172	368	435	444	-

MARQUESINA

Parasol
Parasol
Parasol



● Marrón | Brown | Marron

W 400 cm	W157.48 in
L 300 cm	L 118.11 in
H 248 cm	H 97.64 in

Marquesina plegable de 4 x 3 m en aluminio pintado por pulverización en color gris oscuro con regulador de altura. Tela de poliéster de 300 g/m² en color marrón. No incluye pie.

Foldable marquee with height regulator. 4 x 3 m (157.48 x 118.11 in) size and spray painted aluminium structure in dark grey. 300 g/m² brown polyester fabric. Base not included.

Pergola pliante de 4 x 3 m en aluminium peint en gris foncé avec régulateur de hauteur. Toile marron en polyester de 300 g/m². N'inclut pas le pied.

Compatible con base Stone 25. (mínimo 4 unidades). Ver en pág 345

Goes with Stone 25. (minimum 4 units). See on page 345

Compatible avec Stone 25. (minimum 4 unités). Voir page 345



W: ancho / width / largeur. L: largo / length / longueur
H: altura / height / hauteur. Hs: altura asiento / seat height /
hauteur du siège. Ha: altura brazo / arm height / hauteur du bras
Ø: diámetro / diameter / diamètre.

STD units	Packaging dim. (cm)	M3/pack	NW units (kg)	Units Container 20'	Units Container 40'	Units Container HC	Units Truck 70m ³	Units Truck 100m ³
1	417x25x16	0,17	71	91	182	-	-	-
	+ 104x31x15	+ 0,05						

BRISA

Carpa desplegable
Gazebo foldable
Tente pliable



● Beige | Beige | Beige

W 300 cm | W 118 in
L 300 cm | L 118 in

Estructura fabricada 100% en aluminio anodizado. Plegable y con tubos telescópicos. Las principales piezas de sujeción entre tubos están realizadas en fundición de aluminio. Los tornillos y las tuercas están hechos de acero inoxidable AISI 304. El tejido es de 450gr/m2 de hilo de poliéster plastificado por una cara.

Structure made 100% anodized aluminum. Foldable, with telescopic tubes. The main clamping pieces between tubes are made of cast aluminum. The screws and nuts are made of stainless steel AISI 304. The fabric is 450 gr/m2 of plasticized polyester yarn on one side.

Structure fabriquée 100% en aluminium anodisé. Pliable et équipée de tubes télescopiques. Les pièces principales de fixation entre les tubes sont réalisées en fonte d'aluminium. Les tournevis et écrous sont fabriqués en acier inoxydable AISI 304. Le tissu est de 450gr/m2 de fil de polyester plastifié sur une face.



W: ancho / width / largeur. L: largo / length / longueur
H: altura / height / hauteur. Hs: altura asiento / seat height / hauteur du siège. Ha: altura brazo / arm height / hauteur du bras
Ø: diámetro / diameter / diamètre.

STD units	Packaging dim. (cm)	M3/pack	NW units (kg)	Units Container 20'	Units Container 40'	Units Container HC	Units Truck 70m ³	Units Truck 100m ³
-	160x33x33,5	-	44	160	-	330	-	-

PAPELERAS

BINS | CORBEILLES

PAPERAS | BINS | CORBELLES

Moai ————— 350

Giro ————— 350

MOAI

MAGMA DESIGN

Papelera | Bin | Dechet



Papelera gran capacidad. Cuerpo de polietileno y aro superior en fundición de aluminio. Color personalizable. Uso exterior.

Large-capacity wastepaper basket. Body of polyethylene with ring top in casted aluminium. Outdoor use.

Corbeille grande capacité. Corps en polyéthylène et anneau supérieur en fonte d'aluminium. Usage extérieur.

● Antracita/Jaspeado |
Antracite/Marbling |
Antracite/Percillage

Cap. 200 L	Cap. 52.8 gal.
H 94,2 cm	H 37.19 in
Ø 66,5 cm	Ø 26.08 in

Ref.	STD units	Packaging dim. (cm)	M3/ pack	NW units (kg)	Units Container 20'	Units Container 40'	Units Container HC	Units Truck 70m³	Units Truck 100m³
MOAI-01	4	64x64x94	0,385	15	44	96	-	120	132

GIRO

JORDI BLASI

Papelera | Bin | Dechet



- Azul | Blue | Bleu
- Amarillo | Yellow | Jaune
- Gris | Grey | Gris

Polietileno rotacional con protección UV. Giro-3, Giro-11 y Giro-33 con contrapeso de hormigón. Uso exterior.

Rotomoulded polyethylene protected against UV radiation. Giro-3, Giro-11 and Giro-33, has a concrete weigh base. Outdoor use.

Polyéthylène rotomoulé - Protection UV. Contrepoids en béton pour la Giro-3, Giro-11 et Giro-33. Usage extérieur.

GIRO-01
Papelera de boca superior con cerradura
Top opening wastepaper basket
Corbeille avec ouverture supérieure

Cap. 165 L	Cap. 43.6 gal.
H 96 cm	H 37.8 in
Ø 68 cm	Ø 26.77 in

GIRO-11
Papelera de boca superior sin cerradura
Top opening wastepaper basket
Corbeille avec ouverture supérieure

Cap. 165 L	Cap. 43.6 gal.
H 96 cm	H 37.8 in
Ø 68 cm	Ø 26.77 in

GIRO-02
Papelera de boca superior empotrable con cerradura
Top opening wastepaper basket built in
Corbeille avec ouverture supérieure encastrable avec serrure

Cap. 165 L	Cap. 43.6 gal.
H 96 cm	H 37.8 in
Ø 68 cm	Ø 26.77 in

GIRO-33
Papelera de dos bocas frontales sin cerradura
2 front openings wastepaper basket
Corbeille avec deux ouvertures de face

Cap. 120 L	Cap. 31.7 gal.
H 96 cm	H 39.37 in
Ø 68 cm	Ø 26.77 in

GIRO-03
Papelera de dos bocas frontales con cerradura
2 front openings wastepaper basket
Corbeille avec deux ouvertures de face

Cap. 120 L	Cap. 31.7 gal.
H 96 cm	H 39.37 in
Ø 68 cm	Ø 26.77 in

Ref.	STD units	Packaging dim. (cm)	M3/ pack	NW units (kg)	Units Container 20'	Units Container 40'	Units Container HC	Units Truck 70m³	Units Truck 100m³
GIRO-01	4	65X65X97	0,397	8	44	96	-	120	132
GIRO-02	2	65X65X122	0,603	11	22	48	-	60	66
GIRO-03	2	65X65X100	0,435	38	22	48	-	60	66
GIRO-11	2	65X65X122	0,603	11	22	48	-	60	66
GIRO-33	2	65X65X100	0,435	38	22	48	-	60	66

W: ancho / width / largeur. L: largo / length / longueur
H: altura / height / hauteur. Hs: altura asiento / seat height / hauteur du siège. Ha: altura brazo / arm height / hauteur du bras
Ø: diámetro / diameter / diamètre.



CATERING

MESAS Y CARROS |

TABLES AND TROLLEYS |

TABLE ET CHARIOTS

Rossini	354
Verdi	354
Krauss	356
Beethoven	356
Mozart	357
Yago	357
Strauss	358
Mahler	358
Chopin	359
Smart	359
Smart banco	360

Vivaldi	360
Wagner	361
Bach	361
Hamlet	362
Hamlet 110	362
C1	364
C2	364
C3	365

SILLAS Y CARROS |

CHAIRS AND TROLLEYS |

CHAISES ET CHARIOTS

Josephine	366
Chiavari	367

Napoleon	368
Amadeus	369
Opera	369
Garrotxa	370
Kurt	370
Sam	372
Klaus	372
C5	373
C6	373

ROSSINI

Mesa | Table | Table



315 kg / 693 lb X6

Mesa plegable con estructura de acero pintado. Sobre de polietileno de alta densidad, en color gris claro. Grosor del sobre: 45 mm. Sobre estanco de una sola pieza sin uniones. Peso neto: 12 kg. Travesaños ergonómicos.

Folding painted steel frame table. Table top of high density polyethylene in light grey. Table top thickness: 45 mm. (1.8 in). Leakproof table top in one sole piece without joints. Net weight: 12 kg (26.45 lb). Ergonomic crossbeams.

Table pliable avec structure en acier peint et revêtement en polyéthylène de haute densité de couleur gris clair. Grosseur du plateau de 45 mm. Plateau étanche d'une seule pièce sans raccords. Poids net: 12 kg. Traverses ergonomiques.



Ø 122 cm | Ø 48.03 in
H 74 cm | H 29.13 in

● Gris | Grey | Gris

STD units	Packaging dim. (cm)	M3/ pack	NW units (kg)	Units Container 20'	Units Container 40'	Units Container HC	Units Truck 70m³	Units Truck 100m³
1	123x123x4,4	0,09	12	253	505	566	609	871
34	125x125x215	3,36	12	136	306	306	340	408

VERDI

Mesa | Table | Table



315 kg / 693 lb X7

Mesa plegable con estructura de acero pintado y sobre de polietileno de alta densidad, en color gris claro. Grosor sobre 45 mm. Sobre estanco de una sola pieza sin uniones. Peso neto 19 kg. Travesaños ergonómicos.

Folding painted steel frame table and table top of high density polyethylene in light grey. Table top thickness: 45 mm. (1.8 in). Leakproof table top in one sole piece without joints. Net weight: 19 kg (41.88 lb). Ergonomic crossbeams.

Table pliante avec structure d'acier peint et plateau en polyéthylène de haute densité couleur gris clair. Grosseur plateau 45 mm. Plateau d'une seule pièce. Poids net 19 kg. Traverses ergonomiques.



Ø 152 cm | Ø 59.84 in
H 74 cm | H 29.13 in

● Gris | Grey | Gris

STD units	Packaging dim. (cm)	M3/ pack	NW units (kg)	Units Container 20'	Units Container 40'	Units Container HC	Units Truck 70m³	Units Truck 100m³
1	154x154x5,5	0,14	27	154	320	360	370	529
31	156x156x216	5,25	27	93	217	217	248	279

W: ancho / width / largeur. L: largo / length / longueur
H: altura / height / hauteur. Hs: altura asiento / seat height / hauteur du siège. Ha: altura brazo / arm height / hauteur du bras
Ø: diámetro / diameter / diamètre.

Silla Fiona (pág. 60) con mesa Mozart (pág. 357)

Fiona chair (pag. 60) with Mozart table (pag. 357)

Chaise Fiona (pag. 60) avec table Mozart (pag. 357)



KRAUSS

Mesa | Table | Table



315 kg / 693 lb

X8

Mesa plegable con estructura de acero pintado y sobre de polietileno de alta densidad, en color gris claro. Grosor sobre 50 mm. Sobre estanco de una sola pieza sin uniones. Peso neto 25 kg. Travesaños ergonómicos.

Folding table with powder-coated steel frame and high density polyethylene table top. Table top 50 mm thick. Single piece table top with no joints. Net weight 25 kg (55 lb). Ergonomic crossbeams. Available in light grey.

Table pliante avec structure d'acier peint et plateau en polyéthylène de haute densité couleur gris clair. Grosseur plateau 50 mm. Plateau d'une seule pièce. Poids net 25 kg. Traverses ergonomiques.



Ø 160 cm | Ø 62.99 in
H 74 cm | H 29.13 in

● Gris | Grey | Gris

STD units	Packaging dim. (cm)	M3/ pack	NW units (kg)	Units Container 20'	Units Container 40'	Units Container HC	Units Truck 70m ³	Units Truck 100m ³
1	161x161x6	0,16	25	135	270	333	344	500
32	168x168x35	6,63	25	96	224	224	256	256

BEETHOVEN

Mesa | Table | Table



350 kg / 770 lb

X9

Mesa plegable con estructura de acero pintado y sobre de polietileno de alta densidad, en color gris claro. Grosor sobre 50 mm. Sobre estanco de una sola pieza sin uniones. Peso neto 29 kg. Travesaños ergonómicos.

Folding table with powder-coated steel frame and high density polyethylene table top. Table top 50 mm (1.97 in) thick. Single piece table top with no joints. Net weight 29 kg (63.93 lb). Ergonomic crossbeams. Available in light grey.

Table pliante avec structure d'acier peint et plateau en polyéthylène de haute densité couleur gris clair. Grosseur plateau 50 mm. Plateau d'une seule pièce. Poids net 29 kg. Traverses ergonomiques.



Ø 180 cm | Ø 70.87 in
H 74 cm | H 29.13 in

● Gris | Grey | Gris

STD units	Packaging dim. (cm)	M3/ pack	NW units (kg)	Units Container 20'	Units Container 40'	Units Container HC	Units Truck 70m ³	Units Truck 100m ³
1	182x182x26,5	0,22	29	105	210	235	253	362
30	182x182x235	7,78	29	87	174	174	240	270

W: ancho / width / largeur. L: largo / length / longueur
H: altura / height / hauteur. Hs: altura asiento / seat height / hauteur du siège. Ha: altura brazo / arm height / hauteur du bras
Ø: diámetro / diameter / diamètre.

MOZART

Mesa | Table | Table



350 kg / 770 lb X10



Mesa plegable con estructura de acero pintado y sobre de polietileno de alta densidad, en color gris claro. Grosor sobre 50 mm. Sobre estanco de una sola pieza sin uniones. Peso neto 33 kg. Travesaños ergonómicos.

Folding table with powder-coated steel frame and high density polyethylene table top. Table top 50 mm (1.97 in) thick. Single piece table top with no joints. Net weight 33 kg (72.60 lb). Ergonomic crossbeams. Available in light grey.

Table pliante avec structure d'acier peint et plateau en polyéthylène de haute densité couleur gris clair. Grosseur plateau 50 mm. Plateau d'une seule pièce. Poids net 33 kg. Traverses ergonomiques.

Ø 200 cm | Ø 78.74 in
H 74 cm | H 29.13 in

● Gris | Grey | Gris

STD units	Packaging dim. (cm)	M3/ pack	NW units (kg)	Units Container 20'	Units Container 40'	Units Container HC	Units Truck 70m ³	Units Truck 100m ³
1	202x202x6,5	0,26	33	98	175	200	234	258
30	202x202x35	9,5	33	60	150	150	180	180

YAGO

Mesa | Table | Table



300 kg / 660 lb X4



Mesa plegable con estructura de acero pintado y sobre de polietileno de alta densidad, en color gris claro. Grosor del sobre: 45 mm. Sobre estanco de una sola pieza sin uniones. Peso neto: 9 kg. Travesaños ergonómicos.

Folding table with painted steel frame and high density polyethylene table top in light grey. Table top thickness: 45 mm (1.8 in). Leakproof table top in one sole piece without joints. Net weight: 9 kg (19.84 lb). Ergonomic crossbeams.

Table pliable avec structure en acier peint et revêtement en polyéthylène de haute densité de couleur gris clair. Grosseur du plateau de 45 mm. Plateau étanche d'une seule pièce sans raccords. Poids net: 9 kg. Traverses ergonomiques.

W 87 cm | W 34.25 in
L 87 cm | L 34.25 in
H 74 cm | H 29.13 in

● Gris | Grey | Gris

STD units	Packaging dim. (cm)	M3/ pack	NW units (kg)	Units Container 20'	Units Container 40'	Units Container HC	Units Truck 70m ³	Units Truck 100m ³
1	89x89x5,40	0,05	9	502	1.004	1.125	1.211	1.731
36	91x91x226	1,87	9	432	864	864	1.008	1.152

W: ancho / width / largeur. L: largo / length / longueur
H: altura / height / hauteur. Hs: altura asiento / seat height / hauteur du siège. Ha: altura brazo / arm height / hauteur du bras
Ø: diámetro / diameter / diamètre.

STRAUSS

Mesa | Table | Table



270 kg / 594 lb
 X8

Mesa plegable con estructura de acero pintado y sobre de polietileno de alta densidad, en color gris claro. Grosor sobre 45 mm. Sobre estanco de una sola pieza sin uniones. Peso neto 9 kg. Travesaños ergonómicos.

Folding table with powder-coated steel frame and high density polyethylene table top. Table top thickness: 45 mm (1.8 in). Single piece table top with no joints. Net weight 9 kg (19,84 lb). Ergonomic crossbeams. Available in light grey.

Table pliante avec structure d'acier peint et plateau en polyéthylène de haute densité couleur gris clair. Grosseur plateau 45 mm. Plateau d'une seule pièce. Poids net 9 kg. Traverses ergonomiques.

W 61 cm | W 24.02 in
L 122 cm | L 48.03 in
H 74 cm | H 29.13 in

● Gris | Grey | Gris



STD units	Packaging dim. (cm)	M3/ pack	NW units (kg)	Units Container 20'	Units Container 40'	Units Container HC	Units Truck 70m³	Units Truck 100m³
1	123x62x5,40	0,05	9	571	1.142	1.279	1.378	1.968
36	125x64x226	1,81	9	432	972	972	1.080	828

MAHLER

Mesa | Table | Table



270 kg / 594 lb
 X4

Mesa plegable con estructura de acero pintado y sobre de polietileno de alta densidad, en color gris claro. Grosor del sobre: 45 mm. Sobre estanco de una sola pieza sin uniones. Peso neto: 12 kg. Travesaños ergonómicos. La unión de 2 mesas Mahler permite una composición de 150 x 150 cm. Sistema de unión longitudinal de mesas.

Folding table with painted steel frame and high density polyethylene table top in light grey. Table top thickness: 45 mm (1.8 in). Leakproof table top in one sole piece without joints. Net weight: 12 kg (26.45 lb). Ergonomic crossbeams. The joining of 2 Mahler tables permits a composition of 150 x 150 cm. Longitudinal joining system of the tables.

Table pliable avec structure en acier peint et revêtement en polyéthylène de haute densité de couleur gris clair. Grosseur du plateau de 45 mm. Plateau étanche d'une seule pièce sans raccords. Poids net: 12 kg. Traverses ergonomiques. Le raccord de 2 Mahlers permet une composition de 150 x 150 cm. Système de raccord longitudinal des tables.

W 75,5 cm | W 29.72 in
L 152 cm | L 59.84 in
H 74 cm | H 29.13 in

● Gris | Grey | Gris



STD units	Packaging dim. (cm)	M3/ pack	NW units (kg)	Units Container 20'	Units Container 40'	Units Container HC	Units Truck 70m³	Units Truck 100m³
1	153x77x5,40	0,07	12	375	750	840	905	1.293
36	156x78x226	2,75	12	252	540	540	864	972h

CHOPIN

Mesa | Table | Table



315 kg / 693 lb

X6



W 75,5 cm
L 183 cm
H 74 cm

W 29.72 in
L 72.05 in
H 29.13 in

● Marron | Brown | Marron

● Gris | Grey | Gris

STD units	Packaging dim. (cm)	M3/ pack	NW units (kg)	Units Container 20'	Units Container 40'	Units Container HC	Units Truck 70m ³	Units Truck 100m ³
1	184x77x5,40	0,08	14	333	690	773	832	1.189
36	187x80x226	3,38	14	252	540	540	756	684

Mesa plegable con estructura de acero pintado y sobre de polietileno de alta densidad, en color gris claro y marron. Grosor sobre 45 mm. Sobre estanco de una sola pieza sin uniones. Peso neto 14 kg. Travesaños ergonómicos. Sistema de unión de mesas.

Folding table with powder-coated steel frame and high density polyethylene table top. Table top 45 mm (1.8 in) thick. Single piece table top with no joints. Net weight 14 kg (30.86 lb). Ergonomic crossbeams. Available in light grey and brown. Table joining system.

Table pliante avec structure d'acier peint et plateau en polyéthylène de haute densité couleur gris clair et marron. Grosseur plateau 45 mm. Plateau d'une seule pièce. Poids net 14 kg. Traverses ergonomiques. Système d'union des tables.

SMART

Mesa | Table | Table



315 kg / 693 lb

X6



W 75,5 cm
L 182 cm
H 74 cm

W 29.72 in
L 71.65 in
H 29.13 in

● Gris | Grey | Gris

STD units	Packaging dim. (cm)	M3/ pack	NW units (kg)	Units Container 20'	Units Container 40'	Units Container HC	Units Truck 70m ³	Units Truck 100m ³
1	94x76x9,5	0,07	14	342	684	766	825	1.179
19	215x96x76	1,53	14	342	684	684	798	855

W: ancho / width / largeur. L: largo / length / longueur

H: altura / height / hauteur. Hs: altura asiento / seat height /

hauteur du siège. Ha: altura brazo / arm height / hauteur du bras

Ø: diámetro / diameter / diamètre.

Mesa plegable con estructura de acero pintado y sobre de polietileno de alta densidad, en color blanco. Sobre de 45 mm de grosor con asa para fácil transporte. Tablero articulado para un óptimo almacenaje. Peso neto: 14 kg. Travesaños ergonómicos.

Folding table with painted steel structure and high density polyethylene table top in white. Table top with a 45 mm (1.8 in) thickness and easy to carry handle. Articulated table top board for optimum storage. Net weight: 14 kg (30.86 lb). Ergonomic crossbeams.

Table pliable avec structure en acier peint et plateau en polyéthylène de haute densité de couleur blanche. Plateau de 45 mm. de grosseur avec anse pour faciliter le transport. Plateau articulé pour permettre un rangement optimum. Poids net: 14 kg.

SMART

Banco | Bench | Banc



400 kg / 880 lb
 X6



W 28 cm
L 183 cm
H 42,5 cm

W 11.02 in
L 72.05 in
H 16.73 in

Banco plegable con estructura de acero pintado y asiento de polietileno de alta densidad, en color blanco. Asiento de 50 mm de grosor con asa para fácil transporte. Asiento articulado para un óptimo almacenamiento. Peso neto: 7,7 kg.

Folding bench with painted steel structure and high density polyethylene seat in white. Seat with 50 mm (1.97 in) thickness and easy to carry handle. Articulated seat for optimum storage. Net weight: 7,7 kg (16.97 lb).

Banc pliable avec structure en acier peint et siège en polyéthylène de haute densité de couleur blanche. Siège de 50 mm. de grosseur avec anse pour faciliter le transport. Siège articulé pour un rangement optimum. Poids net: 7,7 kg.

● Gris | Grey | Gris

STD units	Packaging dim. (cm)	M3/ pack	NW units (kg)	Units Container 20'	Units Container 40'	Units Container HC	Units Truck 70m ³	Units Truck 100m ³
1	92,5x28,5x9	0,03	7,7	840	1.680	1.932	2.464	3.200
70	92x113x217	2,25	7,7	840	1.820	1.820	1.960	2.240

VIVALDI

Mesa | Table | Table



350 kg / 770 lb
 X6+2



W 90 cm
L 200 cm
H 74 cm

W 35.43 in
L 78.74 in
H 29.13 in

Mesa plegable con estructura de acero pintado y sobre de polietileno de alta densidad, en color gris claro. Grosor sobre 45 mm. Sobre estanco de una sola pieza sin uniones. Peso neto 18,5 kg. Travesaños ergonómicos. Sistema de unión de mesas.

Folding table with powder-coated steel frame and high density polyethylene table top. Table top 45 mm (1.8 in) thick. Net weight 18,5 kg (40.78 lb). Single piece table top with no joints. Ergonomic crossbeams. Table joining system. Available in light grey.

Table pliante avec structure d'acier peint et plateau en polyéthylène de haute densité couleur gris clair. Grosseur plateau 45 mm. Plateau d'une seule pièce. Poids net 18,5 kg. Traverses ergonomiques. Système d'union des tables.

● Gris | Grey | Gris

STD units	Packaging dim. (cm)	M3/ pack	NW units (kg)	Units Container 20'	Units Container 40'	Units Container HC	Units Truck 70m ³	Units Truck 100m ³
1	202x92,5x5,4	0,11	18,5	256	512	573	617	882
36	202x94x226	4,29	18,5	216	432	432	504	540

W: ancho / width / largeur. L: largo / length / longueur
H: altura / height / hauteur. Hs: altura asiento / seat height / hauteur du siège. Ha: altura brazo / arm height / hauteur du bras
Ø: diámetro / diameter / diamètre.

WAGNER



Mesa | Table | Table

350 kg / 770 lb X8



Mesa plegable con estructura de acero pintado y sobre de polietileno de alta densidad, en color gris claro. Grosor del sobre: 50 mm. Sobre estanco de una sola pieza sin uniones. Peso neto: 20kg. Travesaños ergonómicos.

Folding table with painted steel frame and high density polyethylene table top in light grey. Table tophickness: 50 mm. Leakproof table top in one sole piece without joints. Net weight: 20 kg (44.09 lb).Ergonomic crossbeams.

Table pliante avec structure en acier peint et plateau en polyéthylène de haute densité de couleur gris clair. Grosseur plateau 50 mm. Plateau étanche d'une seule pièce sans raccords. Poids net: 20 kg. Traverses ergonomiques.

● Gris | Grey | Gris

W 75,5 cm	W 29.72 in
L 243 cm	L 95.67 in
H 74 cm	H 29.13 in

STD units	Packaging dim. (cm)	M3/ pack	NW units (kg)	Units Container 20'	Units Container 40'	Units Container HC	Units Truck 70m ³	Units Truck 100m ³
1	244x77,5x40	0,11	20	184	368	412	444	634
31	197x80x242	3,81	20	124	248	248	465	558

BACH



Mesa | Table | Table

315 kg / 693 lb X3



Mesa plegable con estructura de acero pintado y sobre de polietileno de alta densidad, en color gris claro. Grosor sobre 45 mm. Sobre estanco de una sola pieza sin uniones. Peso neto 10 kg. Travesaños ergonómicos.

Folding table with powder-coated steel frame and high density polyethylene table top. Table top 45 mm (1.8 in) thick. Single piece table top with no joints. Net weight 10 kg. (22.05 lb). Ergonomic crossbeams.

Table pliante avec structure d'acier peint et plateau en polyéthylène de haute densité couleur gris clair. Grosseur plateau 45 mm. Plateau d'une seule pièce. Poids net 10 kg. Traverses ergonomiques.

● Gris | Grey | Gris

W 45,5 cm	W 17.91 in
L 183 cm	L 72.05 in
H 74 cm	H 29.13 in

STD units	Packaging dim. (cm)	M3/ pack	NW units (kg)	Units Container 20'	Units Container 40'	Units Container HC	Units Truck 70m ³	Units Truck 100m ³
1	184,5x47x5,4	0,06	10	457	914	1.024	1.103	1.575
62	120x120x235	3,38	10	372	744	744	868	1.240

W: ancho / width / largeur. L: largo / length / longueur
H: altura / height / hauteur. Hs: altura asiento / seat height / hauteur du siège. Ha: altura brazo / arm height / hauteur du bras
Ø: diámetro / diameter / diamètre.

HAMLET

Mesa | Table | Table



170 kg / 374 lb



Mesa plegable con estructura de acero pintado. Sobre de polietileno de alta densidad. Color gris claro. Grosor del sobre: 45 mm. Sobre de estanco de una sola pieza sin uniones. Peso neto: 7,5 kg.

Folding painted steel frame table. Table top of high density polyethylene. Light grey colour. Table top thickness: 45 mm (1.8 in). Leak proof table top in one sole piece without joints. Net weight: 7,5 kg (34.25 lb).

Table pliante avec structure en acier peint et revêtement en polyéthylène de haute densité. Couleur gris clair. Grosseur du plateau: 45 mm. Plateau étanche d'une seule pièce sans raccords. Poids net: 7,5 kg.

● Gris | Grey | Gris

Ø 80 cm | Ø 31.50 in
H 74 cm | H 29.13 in

STD units	Packaging dim. (cm)	M3/ pack	NW units (kg)	Units Container 20'	Units Container 40'	Units Container HC	Units Truck 70m ³	Units Truck 100m ³
1	105x82x5,4	0,05	7,5	423	846	948	1.021	1.458
31	164x112x117	2,15	7,5	-	912	992	-	-

HAMLET 110

Mesa | Table | Table



170 kg / 374 lb



Mesa plegable con estructura de acero pintado y sobre de polietileno de alta densidad. Color gris claro. Grosor del sobre: 45 mm. Sobre de estanco de una sola pieza sin uniones. Peso neto: 8 kg.

Folding table with painted steel frame and high density polyethylene table top. Light grey colour. Table top thickness: 45 mm (1.8 in). Leak proof table top in one sole piece without joints. Net weight: 8 kg (17.95 lb).

Table pliante avec structure en acier peint et revêtement en polyéthylène de haute densité. Couleur gris clair. Grosseur du plateau de 45 mm. Plateau étanche d'une seule pièce sans raccords. Poids net: 8 kg.

● Gris | Grey | Gris

Ø 80 cm | Ø 31.50 in
H 110 cm | H 43.31 in

STD units	Packaging dim. (cm)	M3/ pack	NW units (kg)	Units Container 20'	Units Container 40'	Units Container HC	Units Truck 70m ³	Units Truck 100m ³
1	137x82x5,4	0,05	8	423	846	948	1.021	1.458
31	142x85x197	2,38	8	430	860	860	558	620

W: ancho / width / largeur. L: largo / length / longueur

H: altura / height / hauteur. Hs: altura asiento / seat height / hauteur du siège. Ha: altura brazo / arm height / hauteur du bras

Ø: diámetro / diameter / diamètre.

SISTEMA DE UNIÓN DE MESAS

TABLE JOINING SYSTEM

SYSTÈME D'UNION DE TABLES

Chopin + Chopin ((183+183)x75)
Vivaldi + Vivaldi (198+198)x91)



Sistema de mesas conectables que permite cualquier composición, PATENTE U 200800685 (9).

A system of conectable tables that allow any composition, PATENT U 200800685 (9).

Un système de tables modulables qui permet quelconque composition, BREVET U 200800685 (9).

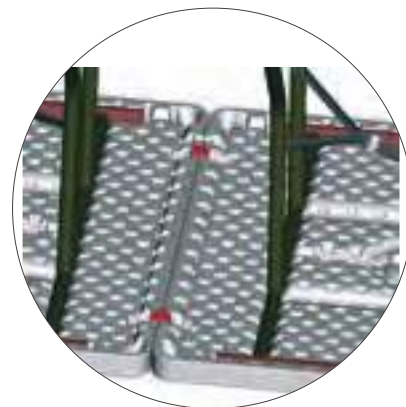

Mahler + Mahler ((75+75)x150)



Sistema de mesas conectables que permite cualquier composición, PATENTE U 200800685 (9).

A system of conectable tables that allow any composition, PATENT U 200800685 (9).

Un système de tables modulables qui permet quelconque composition, BREVET U 200800685 (9).



W: ancho / width / largeur. **L:** largo / length / longueur
H: altura / height / hauteur. **Hs:** altura asiento / seat height /
hauteur du siège. **Ha:** altura brazo / arm height / hauteur du bras
Ø: diámetro / diameter / diamètre.

C1

Carro | Trolley | Chariot



W 83 cm	W 32.68 in
L 132 cm	L 51.97 in
H 112 cm	H 44.09 in

Carro con mango extensible para mesas Beethoven, Verdi, Kraus, Rossini y Mozart. Estructura de acero pintado en color gris. Amplia plataforma de apoyo para las mesas en su posición vertical. Ruedas de poliuretano con frenos incorporados. Mango extensible 3 posiciones para adaptarlo a las diferentes mesas. Capacidad: 12 mesas Beethoven (Ø 180), 12 mesas Verdi (Ø 152), 12 mesas Kraus (Ø 160), 12 mesas Rossini (Ø 122) y 12 mesas Mozart (Ø 200).

Trolley with extendible handle for the Beethoven, Verdi, Kraus, Rossini and Mozart tables. Painted grey steel structure. Wide supporting platform for the tables in vertical position. Polyurethane wheels with incorporated brakes. Extendible 3-position handle for adapting it to the different tables. Capacity: 12 Beethoven tables (Ø 180), 12 Verdi tables (Ø 152), 12 Kraus tables (Ø 160), 12 Rossini tables (Ø 122) and 12 Mozart tables (Ø 200).

Chariot avec poignée extensible pour tables Beethoven, Verdi, Kraus, Rossini et Mozart. Structure en acier peint de couleur grise. Grande plateforme de soutien pour les tables positionnées à la verticale. Roues en polyuréthane avec freins incorporés. Manche extensible à 3 positions, adaptable aux différentes tables. Capacité: 12 Beethoven (Ø 180), 12 Verdi (Ø 152), 12 Kraus (Ø 160), 12 Rossini (Ø 122) et 12 Mozart (Ø 200).

● Gris | Grey | Gris

STD units	Packaging dim. (cm)	M3/ pack	NW units (kg)	Units Container 20'	Units Container 40'	Units Container HC	Units Truck 70m³	Units Truck 100m³
1	140x102x15	0,21	24,4	126	315	315	380	380

C2

Carro | Trolley | Chariot



Carro con mango abatible para mesa Strauss. Estructura de acero pintado en color gris. Postes verticales extraíbles en el perímetro del carro para inmovilizar las mesas apiladas. Ruedas de poliuretano con frenos incorporados. Capacidad: 20 mesas Strauss (122 x 61 cm). Hasta fin de existencias.

Trolley with folding handle for Strauss tables. Painted grey steel structure. Extractable vertical posts around the trolley in order to immobilize the stacked tables. Polyurethane wheels with incorporated brakes. Capacity: 20 Strauss tables (122 x 61 cm). Until the end of stock.

Chariot avec poignée rabattable pour table Strauss. Structure en acier peint de couleur grise. Poteaux verticaux extractibles dans le périmètre du chariot pour immobiliser les tables empilées. Roues en polyuréthane avec freins incorporés. Capacité: 20 tables Strauss (122 x 61 cm). Jusqu'à la fin du stock.

● Gris | Grey | Gris

Hasta fin de existencias |
Until the end of stock |
Jusqu'à épuisement du stock

W 62 cm	W 24.41 in
L 132 cm	L 51.97 in
H 115 cm	H 45.28 in

W: ancho / width / largeur. L: largo / length / longueur
H: altura / height / hauteur. Hs: altura asiento / seat height / hauteur du siège. Ha: altura brazo / arm height / hauteur du bras
Ø: diámetro / diameter / diamètre.

STD units	Packaging dim. (cm)	M3/ pack	NW units (kg)	Units Container 20'	Units Container 40'	Units Container HC	Units Truck 70m³	Units Truck 100m³
1	138x72x15	0,15	15,2	126	312	312	376	376

C3

Carro | Trolley | Chairiot



Carro con mango abatible y base extensible para mesas Chopin, Wagner y Mahler. Estructura de acero pintado en color gris. Postes verticales extraíbles en el perímetro del carro para inmovilizarlas mesas apiladas. Ruedas de poliuretano con frenos incorporados. Capacidad: 20 mesas Chopin (183 x 75,50 cm), 18 mesas Wagner (234 x 75,50 cm), y 20 Mahler (152 x 75,50 cm).

Trolley with folding handle and extensible base for Chopin, Wagner and Mahler tables. Painted grey steel structure. Extractable vertical posts around the trolley in order to immobilize the stacked tables. Polyurethane wheels with incorporated brakes. Capacity: 20 Chopin tables (183 x 75,50 cm), 18 Wagner tables (234 x 75,50 cm) and 20 Mahler tables (152 x 75,50 cm).

Chariot avec poignée rabattable et base extensible pour tables Chopin, Wagner et Mahler. Structure en acier peint de couleur grise. Poteaux verticaux extractibles dans le périmètre du chariot pour immobiliser les tables empilées. Roues en polyuréthane avec freins incorporés. Capacité: 20 tables Chopin (183 x 75,50 cm), 18 tables Wagner (234 x 75,50 cm), et 20 Mahler (152 x 75,50 cm).

W 77 cm	W 30.31 in
L 191 cm	L 75.20 in
H 115 cm	H 45.28 in

● Gris | Grey | Gris

STD units	Packaging dim. (cm)	M3/ pack	NW units (kg)	Units Container 20'	Units Container 40'	Units Container HC	Units Truck 70m³	Units Truck 100m³
1	196x85x15	0,25	21,4	70	184	184	222	222

JOSEPHINE

Silla | Chair | Chaise



Siesta
exclusive

W: ancho / width / largeur. **L:** largo / length / longueur
H: altura / height / hauteur. **Hs:** altura asiento / seat height /
 hauteur du siège. **Ha:** altura brazo / arm height / hauteur du bras
Ø: diámetro / diameter / diamètre.

Silla inyectada en fibra de vidrio y PP mediante tecnología de moldeo asistida por gas. Para uso interior y exterior.

Chair injected with fiberglass and PP using gas assisted injection technology. For indoor and outdoor use.

Chaise injectée avec fibre de verre et PP, en utilisant technologie de moulage assistée par gaz. Pour intérieur et extérieur.

○ Blanco | White | Blanc

● Negro | Black | Noir

W 45 cm	W 17.72 in
L 55 cm	L 21.65 in
H 91 cm	H 35.82 in
Hs 46 cm	Hs 18.11 in

STD units	Packaging dim. (cm)	M3/ pack	NW units (kg)	Units Container 20'	Units Container 40'	Units Container HC	Units Truck 70m³	Units Truck 100m³
20	47x229x95	1,02	4	600	1.240	1.240	-	1.400



CHIAVARI

Silla | Chair | Chaise



Siesta
FURNITURE

W: ancho / width / largeur. **L:** largo / length / longueur
H: altura / height / hauteur. **Hs:** altura asiento / seat height /
 hauteur du siège. **Ha:** altura brazo / arm height / hauteur du bras
Ø: diámetro / diameter / diamètre.

Silla apilable para uso interior y exterior. Inyectada en policarbonato. Protección U.V. Otros colores disponibles, consulte el Departamento Comercial.

Stackable chair for indoor and outdoor use. Injected in polycarbonate. U.V. protection. Other available colours, contact the Sales Department.

Chaise empilable pour intérieur et extérieur. Injectée en polycarbonate. Protection U.V. Autres couleurs disponibles, consultez le Département Commerciale.

- Blanco | White | Blanc
- Transparente | Transparente | Transparente

W 45 cm	W 17.72 in
L 51 cm	L 20.07 in
H 91 cm	H 35.82 in
Hs 45 cm	Hs 17.71 in

STD units	Packaging dim. (cm)	M3/ pack	NW units (kg)	Units Container 20'	Units Container 40'	Units Container HC	Units Truck 70m³	Units Truck 100m³
4	46x66x107	0,325	4,6	360	864	864	-	960



NAPOLEON

Silla | Chair | Chaise



Apilable
Stackable | Empilable

Siesta
CATERING

W: ancho / width / largeur. **L:** largo / length / longueur

H: altura / height / hauteur. **Hs:** altura asiento / seat height / hauteur du siège. **Ha:** altura brazo / arm height / hauteur du bras

Ø: diámetro / diameter / diamètre.

Silla inyectada en fibra de vidrio y PP mediante tecnología de moldeo asistida por gas. Para uso interior y exterior.

Chair injected with fiberglass and PP using gas assisted injection technology. For indoor and outdoor use.

Chaise injectée avec fibre de verre et PP, en utilisant technologie de moulage assistée par gaz. Pour intérieur et extérieur.

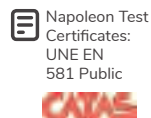

○ Blanco | White | Blanc

● Negro | Black | Noir

● Dorado | Golden | Doré

● Plateado | Silver | Argent

W 45 cm

L 55 cm

H 92 cm

Hs 47 cm

W 17.72 in

L 21.65 in

H 36.22 in

Hs 18.50 in

STD units	Packaging dim. (cm)	M3/pack	NW units (kg)	Units Container 20'	Units Container 40'	Units Container HC	Units Truck 70m³	Units Truck 100m³
4	58,5x73,5x103	0,44	4	192	416	416	464	464
20	47x229x95	1,02	4	600	1.240	1.240	-	1.400



AMADEUS

Silla | Chair | Chaise

Amadeus Test
Certificates:
UNE EN
581 PUBLIC



Silla apilable de aluminio lacado y espuma inyectada tapizada. Disponible en tela estándar y -bajo pedido- en CRIB 5.

Stackable lacquered aluminium chair with injected upholstered foam. Available in standard fabric and CRIB-5 fabric (upon request)

Chaise empilable en aluminium laqué et mousse injectée tapissée. Disponible en toile standard et - sur commande - en toile non-feu CRIB-5.

W 45 cm	W 17.72 in
L 52 cm	L 20.47 in
H 93 cm	H 36.61 in

Estructura Oro | Gold structure | Structure Or

● Azul | Blue | Bleu

● Burdeos | Burgundy | Bordeaux

Estructura Plata | Silver structure | Structure Argent

● Azul | Blue | Bleu

● Burdeos | Burgundy | Bordeaux

Estructura Negra | Black structure | Structure Noir

● Antracita | Antracite | Antracite



Fundas y lazos textiles disponibles. Consulte al departamento comercial. | Covers and ribbons available. Ask the commercial department. | Couvertures et liens textiles disponibles. Consultez au département commercial.

STD units	Packaging dim. (cm)	M3/ pack	NW units (kg)	Units Container 20'	Units Container 40'	Units Container HC	Units Truck 70m³	Units Truck 100m³
12	47x67x230	0,72	3,2	480	1.056	1.056	1.200	1.380

OPERA

Silla | Chair | Chaise

Amadeus Test
Certificates:
UNE EN
581 PUBLIC



Silla apilable de aluminio lacado y espuma inyectada tapizada. Disponible en tela estándar y -bajo pedido- en CRIB-5. Estructura oro.

Stackable lacquered aluminium chair with injected upholstered foam. Available in standard fabric and CRIB-5 fabric (upon request). Gold structure.

Chaise empilable en aluminium laqué et mousse injectée tapissée. Disponible en toile standard et -sur commande- en toile non-feu CRIB-5. Structure or.

W 45 cm	W 17.72 in
L 52 cm	L 20.47 in
H 93 cm	H 36.61 in

● Azul | Blue | Bleu

● Burdeos | Burgundy | Bordeaux



Fundas y lazos textiles disponibles. Consulte al departamento comercial. | Covers and ribbons available. Ask the commercial department. | Couvertures et liens textiles disponibles. Consultez au département commercial.

W: ancho / width / largeur. L: largo / length / longueur
H: altura / height / hauteur. Hs: altura asiento / seat height / hauteur du siège. Ha: altura brazo / arm height / hauteur du bras
Ø: diámetro / diameter / diamètre.

STD units	Packaging dim. (cm)	M3/ pack	NW units (kg)	Units Container 20'	Units Container 40'	Units Container HC	Units Truck 70m³	Units Truck 100m³
12	47x67x230	0,72	4	-	1.056	1.056	1.200	1.200

GARROTXA

Silla | Chair | Chaise

Silla apilable para uso interior y exterior. Inyectada en polipropileno. Especialmente indicada para ser cubierta con una funda para su utilización en banquetes. Peso neto 2,60 kg. Protección UV.

Chair for indoor and outdoor use. Injected with polypropylene. Stackable. Chair cover recommended for use in banquets. Net weight 2,60 kg (5.72 lb). UV Protection.

Chaise pour intérieur et extérieur. Injectée en polypropylène. Empilable. Possibilité de recouvrir la chaise d'une housse lors des banquetes. Poids net 2,60 kg. UV protection.

Blanco | White | Blanc

Antracita | Anthracite | Anthracite

Verde Oscuro | Dark Green | Vert Foncé

Negro | Black | Noir

W 43,6 cm	W 17.17 in
L 52 cm	L 20.47 in
H 89 cm	H 35.04 in



 Apilable
Stackable | Empilable



Fundas y lazos textiles disponibles. Consulte al departamento comercial. | Covers and ribbons available. Ask the commercial department. | Couvertures et liens textiles disponibles. Consultez au département commercial.

STD units	Packaging dim. (cm)	M3/ pack	NW units (kg)	Units Container 20'	Units Container 40'	Units Container HC	Units Truck 70m ³	Units Truck 100m ³
22	55x45x240	0,59	2,6	1.100	2.376	2.552	1.728	1.728
88	110x90x240	2,38	2,6	-	-	2.288	2.464	2.992

KURT

Silla | Chair | Chaise

Silla apilable de respaldo alto para interior y exterior de polipropileno inyectado. Especialmente indicada para ser cubierta con una funda para su utilización en banquetes. Peso neto: 3 kg. Protección UV.

Polypropylene-injected stackable high back chair for indoor and outdoor use. Especially indicated for using with a chair cover at banquets. Net weight: 3 kg (6.6 lb). UV protection.

Chaise empilable avec dossier haut en polypropylène pour intérieur et extérieur. Possibilité de recouvrir la chaise d'une housse lors des banquetes. Poids net: 3 kg. UV protection.

Blanco | White | Blanc

W 43 cm	W 16.93 in
L 47 cm	L 18.50 in
H 97 cm	H 38.19 in



 Apilable
Stackable | Empilable



Fundas y lazos textiles disponibles. Consulte al departamento comercial. | Covers and ribbons available. Ask the commercial department. | Couvertures et liens textiles disponibles. Consultez au département commercial.

STD units	Packaging dim. (cm)	M3/ pack	NW units (kg)	Units Container 20'	Units Container 40'	Units Container HC	Units Truck 70m ³	Units Truck 100m ³
24	40x55x220	0,48	3	-	-	-	1.728	1.728
48	80x110x220	1,94	3	-	1.440	1.440	c	1.728

W: ancho / width / largeur. L: largo / length / longueur
H: altura / height / hauteur. Hs: altura asiento / seat height / hauteur du siège. Ha: altura brazo / arm height / hauteur du bras
Ø: diámetro / diameter / diamètre.

Silla Garrotxa (pág. 370) con funda y lazo
Consultar con nuestro equipo comercial las opciones de textiles

Garrotxa chair (pag. 370) with cover and ribbon
Ask our sales team for covers and textiles options

Chaise Garrotxa (pag. 370) avec housses et noeud
Consulter les options de textile et housses à notre équipe commerciale



SAM

Silla | Chair | Chaise

Amadeus Test
Certificates:
UNE EN
581 PUBLIC



Sistema de enlace
Clamp connection
Pince ensamblement



Silla plegable con estructura de acero pintado, con respaldo y asiento en polipropileno de alta densidad en 2 versiones: gris o negro. Disponible con sistema de enlace de sillas para convenciones y eventos. Protección UV.

Folding chair with powder-coated steel structure. High density polypropylene back and seat. Available in grey and black. Clamp connection of chairs for conventions and events available. UV protection.

Chaise pliante avec structure en acier peint, avec dossier et siège en polypropylène de hautedensité en 2 versions: gris ou noir. Pince de jonction des chaises pour conventions et événements disponible. UV protection.

● Gris Claro | Light Grey | Gris Clair

● Negro | Black | Noir

W 45,5 cm	W 17.91 in
L 49,5 cm	L 19.49 in
H 81,5 cm	H 32.09 in
Hs 45 cm	Hs 17.72 in

STD units	Packaging dim. (cm)	M3/ pack	NW units (kg)	Units Container 20'	Units Container 40'	Units Container HC	Units Truck 70m³	Units Truck 100m³
8	45x30,5x98	13	3,5	2.160	4.200	5.120	-	-

KLAUS

Silla | Chair | Chaise

Amadeus Test
Certificates:
UNE EN
581 PUBLIC



Silla plegable con estructura de acero pintado gris, con respaldo y asiento en polietileno de alta densidad color gris claro. Protección UV. Incluye clip de seguridad cumpliendo con la normativa contract.

Folding chair with powder-coated steel frame in grey. High density polyethylene back and seat. Available in light grey. UV protection. Safety clip to comply with contract standards.

Chaise pliante avec structure en acier peint en gris, avec dossier et siège en polyéthylène de hautedensité couleur gris clair. UV protection. Clip de sécurité pour répondre à la norme contract.

● Gris Claro | Light Grey | Gris Clair

W 49 cm	W 19.29 in
L 46 cm	L 18.11 in
H 85 cm	H 33.46 in

STD units	Packaging dim. (cm)	M3/ pack	NW units (kg)	Units Container 20'	Units Container 40'	Units Container HC	Units Truck 70m³	Units Truck 100m³
4	114x27x47	0,17	4,75	610	1.544	1.544	1.860	1.860

W: ancho / width / largeur. L: largo / length / longueur
H: altura / height / hauteur. Hs: altura asiento / seat height / hauteur du siège. Ha: altura brazo / arm height / hauteur du bras
Ø: diámetro / diameter / diamètre.

C5

Carro | Trolley | Chairot



● Gris | Grey | Gris

W 48 cm | W 18.90 in
L 110 cm | L 43.31 in
H 190 cm | H 74.80 in

W: ancho / width / largeur. **L:** largo / length / longueur
H: altura / height / hauteur. **Hs:** altura asiento / seat height /
hauteur du siège. **Ha:** altura brazo / arm height / hauteur du bras
Ø: diámetro / diameter / diamètre.

STD units	Packaging dim. (cm)	M3/pack	NW units (kg)	Units Container 20'	Units Container 40'	Units Container HC	Units Truck 70m ³	Units Truck 100m ³
1	114x52x12	0,07	16,8	250	656	656	791	791

Carro para sillas Klaus. Estructura de acero pintado en color gris. Montantes verticales en el perímetro del carro para inmovilizar las sillas apiladas. Ruedas de poliuretano con frenos incorporados. Doble asa de sujeción. Capacidad: 30 sillas Klaus (49 x 85 cm).

Trolley for Klaus chairs. Painted grey steel structure. Extractable vertical posts around the trolley in order to immobilize the stacked chairs. Polyurethane wheels with incorporated brakes. Double gripping handles. Capacity: 30 Klaus chairs (49 x 85 cm).

Chariot pour chaises Klaus. Structure en acier peint de couleur grise. Montants verticaux extractibles dans le périmètre du chariot pour immobiliser les chaises empilées. Roues en polyuréthane avec freins incorporés. Double poignée de fixation. Capacité: 30 chaises Klaus (49 x 85 cm).

C6

Carro | Trolley | Chairot



● Gris | Grey | Gris

W 48 cm | W 18.90 in
L 112 cm | L 44.09 in
H 197 cm | H 77.56 in

W: ancho / width / largeur. **L:** largo / length / longueur
H: altura / height / hauteur. **Hs:** altura asiento / seat height /
hauteur du siège. **Ha:** altura brazo / arm height / hauteur du bras
Ø: diámetro / diameter / diamètre.

STD units	Packaging dim. (cm)	M3/pack	NW units (kg)	Units Container 20'	Units Container 40'	Units Container HC	Units Truck 70m ³	Units Truck 100m ³
1	98x50x15	0,06	16,8	300	754	754	910	910

Carro para sillas Sam. Estructura de acero pintado en color gris. Montantes verticales en el perímetro del carro para inmovilizar las sillas apiladas. Ruedas de poliuretano con frenos incorporados. Doble asa de sujeción que sobresale 2 cm de la estructura. Capacidad: 60 sillas Sam (45,5 x 81,50 cm).

Trolley for Sam chairs. Painted grey steel structure. Extractable vertical posts around the trolley in order to immobilize the stacked chairs. Polyurethane wheels with incorporated brakes. Double gripping handles that protrude 2 cm from the structure. Capacity: 60 Sam chairs (45,5 x 81,50 cm).

Chariot pour chaises Sam. Structure en acier peint de couleur grise. Goujons verticaux extractibles dans le périmètre du chariot pour immobiliser les chaises empilées. Roues en polyuréthane avec freins incorporés. Double poignée de fixation dépassant de 2 cm de la structure. Capacité: 60 chaises Sam (45,5 x 81,50 cm).

DE ACUERDO CON LOS ESTÁNDARES BIFMA |

ACCORDING TO BIFMA STANDARDS | EN ACCORD AVEC LES DEMANDES BIFMA

Los más de 50 años de experiencia de Resol en la fabricación de mobiliario de grandes dimensiones en cualquier material plástico (polipropileno, poliamida, policarbonato, polietileno...) así como en el diseño y construcción de moldes, han permitido a la compañía desarrollar el mejor programa de sillas y mesas “blow moulded” de Polietileno de Alta Densidad para uso profesional.

Resol Contract es líder mundial en el mercado de mobiliario para hostelería en productos de tecnología “blow moulded” que destacan por:

→ Dureza y capacidad para soportar peso con estructuras metálicas, uniones y soldaduras súper reforzadas (test de nivel de resistencia de acuerdo con estándar Bifma*).

→ Estabilidad y ergonomía para el confort de los comensales.

→ Resistencia a fuertes impactos.

→ Resistencia a la humedad.

→ Ligereza para un fácil traslado o transporte.

→ Mesas con patas plegables con un mecanismo fácil y seguro.

→ Bajo mantenimiento, fácil limpieza y alta durabilidad.

→ La gama más amplia del mercado en mesas, carros, sillas y fundas para catering y convenciones.

More than 50-year experience of Resol with regard to the manufacturing of king size furniture in any plastic material (polypropylene, polyamide, polycarbonate, polyethylene...) as well as the corresponding mould design and construction, has permitted developing the best High Density Polyethylene “blow moulded” program for chairs and tables for professional use. Resol Contract is world leader in the furniture market for “blow moulded” technology products in the hotel industry. These stand out of:

→ Their hardness and capacity for supporting weight highly reinforced metallic structures, joints and welding (according to Bifma resistance standards*).

→ Their stability and ergonomoy.

→ Their resistance to hard impacts.

→ Their resistance to humidty.

→ Their lightness for easy moving or transport.

→ Their leg folding an unfolding mechanism, easy and safe.

→ Their low maintenance, easy cleaning and log durability.

→ The most extensive existing range of tables, trolleys, chairs and covers for catering and conventions.

—

Avec plus de 50 ans d'expérience du Resol dans la fabrication de mobilier de grandes dimensions toutes matières plastiques (polypropylène, polyamide, polycarbonate, Polyéthylène...) ainsi que dans la conception et la construction des moules, ont permis de mettre en place le meilleur programme de chaises et de tables “blow moulded” en Polyéthylène de Haute Densité à usage professionnel.

Resol Contract est le leader mondial sur le marché du mobilier pour l'hôtellerie concernant les produits de technologie “blow moulded”. Ces produits se caractérisent par:

→ Leur robustesse et capacité à supporter le poids grâce à leurs structures métalliques, raccords et soudures super-renforcées (en accord avec les demandes BIFMA de résistance*).

→ Leur stabilité et ergonomie.

→ Leur résistance aux impacts violents.

→ Leur résistance à l'humidité.

→ Leur légèreté pour un transfert ou un transport facile.

→ Leur mécanisme de pliage et de dépliage des pieds, facile et sans risque.

→ Leur faible entretien, leur facilité à nettoyer et leur durée de vie élevée.

→ La plus grande gamme existente de tables, chariots, chaises et housses pour la restauration et les conventions.

GARANTÍA

WARRANTY

GARANTIE

Resol es el único fabricante del mundo que ofrece:

- Un sistema de mesas conectables que permite cualquier composición, PATENTE U 200800685 (9)
- Dos versiones: ancho 75 / ancho 91
- Resistencia probada para uso contract
- La gama existente más amplia de mesas, carros, sillas y fundas para catering y convenciones

—

Resol is the only manufacturer in the world who offers:

- A system of connectable tables that allow any composition, PATENT U 200800685 (9)
- Two versions: width 75 / width 91
- Proven resistance for catering and hotel use
- The most extensive existing range of tables, trolleys, chairs and covers for catering and conventions

—

Resol est le seul fabriquant du monde qui propose:

- Un système de tables modulables qui permet quelconque composition, BREVET U 200800685 (9)
- Deux versions: largeur 75 / largeur 91
- Résistance testée pour un usage dans l'hôtellerie
- La plus grande gamme existante de tables, chariots, chaises et housses pour la restauration et les conventions.



Según condiciones legales y comerciales establecidas en <http://www.resol.es/es/garantias.aspx>. Solamente para los modelos determinados en estas condiciones de garantía.

According to legal and commercial conditions set forth in <http://www.resol.es/es/garantias.aspx>. Only for the models specified in these warranty conditions.

Selon les conditions juridiques et commerciales énoncées sur <http://www.resol.es/es/garantias.aspx>. Seulement pour les modèles indiqués avec ces conditions de garantie.



PROMOCIONAL

PROMOTIONAL

PROMOTIONNEL

Resol es consciente de la importancia que tiene para sus clientes la personalización de sillas, mesas, taburetes y parasoles. Por este motivo, pone a la disposición de sus clientes las técnicas de inmoulding, serigrafía y adhesivo de alta adherencia. Cada técnica es específica para un tipo de acabado y objetivo. El inmoulding precisa de un estudio previo del producto para su realización. La serigrafía permite colocar el logo de su compañía en cualquier superficie plana y puede ser eliminado mediante productos químicos. El adhesivo de alta adherencia es una posibilidad que sin cantidades mínimas elevadas nos permite ofrecer una personalización rápida y ágil de cualquier tipo de superficie de plástico. Consulte con el Departamento Comercial para tener más información de cualquier de estas técnicas de personalización.

Resol understands the importance to its customers concerning the customization of chairs, tables, stools and umbrellas. For this reason, Resol offers the techniques of inmoulding, screen printing and high tack adhesive. Each technique is specific to a type of finish and objective. The inmoulding requires previous study of the product for the production. The screen printing allows you to place your company logo on any flat surface and it can be removed using chemicals. The high tack adhesive allows Resol to offer fast and flexible customization of any plastic surface with low MOQ. Consult Sales Department for more information on any of these personalization techniques.

Resol comprend l'importance que la personnalisation des chaises, des tables, des tabourets et des parasols a pour ses clients. Pour cette raison, Resol Groupe met à la disposition de ses clients les techniques d'inmoulding, de la sérigraphie et de l'adhésif haute adhérence. Chaque technique est spécifique à un type de finition et objective. Le inmoulding nécessite l'étude précédente du produit pour la production. La sérigraphie permet de placer le logo de votre entreprise sur une surface plane et peut être retiré à l'aide de produits chimiques. L'adhésif haute adhérence permet, sans quantités minimales élevées, d'offrir la personnalisation rapide et flexible de toute surface en plastique. Consultez le Département Commercial pour plus d'informations sur ces techniques de personnalisation.



Tecnologías de personalización Personalization technologies Technologies de personnalisation	Inmoulding	Serigrafía Screenprint Sérigraphie	Tampografía Pad printing Tampographie
Se realiza en el momento de la producción de la silla Is performed at the time of production of the chair Est effectuée au moment de la production de la chaise	●		●
Personalización permanente Permanent customization Personnalisation permanente	●		●
Color Colour Couleur	●	●	●



Restaurant Boacam, Figueres
Rossend Cortés Interiors





Bar Charlotte, Cádiz
Estudio Decoración Vintage



Ri&Co Bistró Restaurant, Castellón
Estudio Vitale





AGRADECIMIENTOS

ACKNOWLEDGEMENTS

REMERCIEMENTS

→ Santorini Water Fantasy Park (Cha-am Petchburi – Thailand), Hotel Meliá Varadero (Varadero – Cuba), Sant Cugat Business Park (Sant Cugat), Hotel Resguard dels Vents (Ribes de Freser), Restaurant Es Boldadó (Eivissa), Festival (a)phònica (Banyoles), Hospital Sant Pau (Barcelona), Piscina Municipal (Sant Esteve d'en Bas), Camping Solmar (Blanes), Hotel Medplaya Riviera (Benalmádena), Centre de Convencions (Sabadell), Centre Esportiu Illa Activa (Cabriels), Restaurante Ca Consuelo (L'Eliana), The Xara Lodge (Rabat - Malta), Hotel Monte Igueldo (San Sebastián), Ajuntament Sant Cugat del Vallès, Hotel Sofia (Sitges), Ajuntament de Palma de Mallorca, Restaurante Vora Estany (Banyoles), Restaurante Bellavista (Santiago – Chile), Restaurante Carlota (Punta Cana), Centro Comercial Larcomar (Lima – Perú), Duple Meze Restaurant (Istanbul– Turkey), Superba Food & Bread (Los Angeles – USA), Círculo de las Bellas Artes (Madrid), Restaurant La Brasa (Olot), Hotel Voyage Sorgun (Pinar – Turkey), Restaurant Saizeriya (Tokio), Restaurante Miramar (Murcia), Restaurant Lizarran Les Corts (Barcelona), Bar Shade (Sofía – Bulgaria), Restaurant Ca L'Enric (La Vall de Bianya), Xiringuito platja (Platja d'Aro), Lalo Restaurant (Polonia), Academy Café Football Club Dinamo, Pink Bakery (Ciudad de Panamá), Aquahotel (Santa Susana), Rossend Cortés Interiors, Bodegas Dinastia Vivanco (Briones), Restaurant Boacam (Figueres), Celler de Can Roca, Restaurant "La Cabana de Berga", Bar Charlotte, (Cádiz) Estudio Decoración Vintage, Ri&Co Bistró Restaurant (Castellón) Estudio Vitale, Escola Elisava (Barcelona), Amieva Studio, Pablo López Huidobro, Estudi Gràfic Joel Macias, Estudi Fura, a nuestros diseñadores y a todo el equipo de Resol.

GUÍA DE COLOR RESOL Dd | COLOR GUIDE RESOL Dd | GUIDE DES COULEURS RESOL Dd

COLOR	PANTONE	RAL
○ Blanco White Blanc		RAL 9016
● Negro Black Noir		RAL 9005
● Rojo Red Rouge	Pantone 485C	
● Verde oliva Olive green Vert oli	Pantone 5777C	
● Chocolate Chocolate Chocolate	Pantone Warm Gray 11C	RAL 7006
● Arena Sand Sable	NSC S 5010- Y 10 R	RAL 1019
● Gris oscuro Dark grey Gris foncé	Pantone 425C	RAL 7024
● Naranja Orange Orange	Pantone 1505C	
● Verde lima Lime green Vert lime	Pantone 396C	
● Rosa Pink Rose	Pantone 230C	
● Azul cielo Light blue Bleu ciel	Pantone 543C	
● Azul retro Blue retro Bleu retro	Pantone 7697C	
● Melocotón Peach Pêche	Pantone 7579C	
● Caldera Red-orange Orangé Rouge	Pantone 718C	RAL 2001
● Gris verdoso Green-grey Gris Vert	Pantone 7538C	RAL 7033
● Marfil Ivory Ivoire		RAL 1013
● Fucsia Fuchsia Fuchsia	Pantone 214C	
● Aquamint Aquamint Aquamint	Pantone 2253C	
● Vainilla Vanilla Vainilla	Pantone 7499C	
● Toscano Tuscan Toscane	Pantone 7556C	
● Turquesa Turquoise Turquoise	Pantone 5493C	
● Burdeos Burgundy Bordeaux		RAL 3004



Estos colores son aproximados. Para tener referencias reales, pedir plaquetas de color al Departamento Comercial. Los colores y las imágenes son representativas y en ningún caso podrán ser motivo de reclamación.

These colors are approximate. For real references, ask for color swatches to the Commercial Department. The colours and images are representative and in any case can not be a reason for a complaint.

Ces couleurs sont approximatives. Pour avoir les références réelles, demander des échantillons de couleurs au département commercial. Les couleurs et les images sont représentatives et, en tout cas, ne peuvent pas être à l'origine de plaintes

resol

Crta. Santa Coloma, km 46
17178 Les Preses, Girona | ESP

Tel: +34 972 69 47 00
Fax: +34 972 69 21 00
E-mail: info@resol.es

www.resol.es

[f/Resol.Grupo](https://www.facebook.com/Resol.Grupo)

[t/ResolGrupo](https://twitter.com/ResolGrupo)

[in/company/grupo-resol](https://www.linkedin.com/company/grupo-resol)

